

The right choice for the ultimate yield!

LS ELECTRIC strives to maximize your profits in gratitude for choosing us as your partner.

Human Machine Interface

XP-Builder 3.50

XGT Panel

User's Manual



Safety Instructions

- Read this manual carefully before installing, wiring, operating, servicing or inspecting this equipment.
- Keep this manual within easy reach for quick reference.

LSELECTRIC

Revision History

Version	Date	Major Change	Revised Page
V 1.30	'13.11	1 st edition	-
V 1.33	'15.08	Revised to version 1.33	Full revision
V 2.00	'15.12	Revised to version 2.00	Full revision
V 2.01	'17.01	Revised to version 2.01	Full revision
		Add IPC Series	Full revision
		2.2.2.6 Resize font when it use Text Table if the width of rectangle is greater than the text width	P2-17
		2.2.2.9 Don't show communication error after it is closed	P2-22
		2.2.2.12 wipe Settings	P2-28
		2.2.3.2 Check 'Include Upload Project file' on Project Download as Default	P2-31
		2.3.10 Renaming a Tag to add as a New Tag	P2-80
V2.11	'18.08	Window 10 home edition not supported Add iXP2 Series Add HDMI expanded Settings Add Resize font in case object region is larger than the text length while Text Table or Device Address Show is used Add Device type in Global Script Settings Add Screen change gesture option Add HDMI Screen Settings Add HDMI screen insert method Add HDMI Initial Screen Setting Method Add Don't allow change this screen by gesture Add Registering Figures/Objects Add Formatting Text in an Object/Objects Add Finding and Replacing All Fonts Add Execute Project at Local wXP Add Error Messages (2030 ~ 2037) Add _T500MS on/off system tag Add _Alarm_Norecovery_Device_Num, _Alarm_Norconfirm_Device_Num Add Extended File Recipe	

		Add Char. Spacing, Line Spacing	
		Add Setting Device Size per Col. At Logging viewer	
		Add Fit to the max header length at Logging viewer	
		Add Gesture&Multi-Touch	
		Add Caution	
V2.20	'19.04	Add iXP2H-07XXD	P1-16, P2-3
		Add details on the iXP2 HDMI Extension features	P2-14
		Add password mode locked on screen feature when switching screen	P2-17
		Add global external switchn feature	P2-28
		Add description for the iXP2H-07XXD H/W KEY	P2-94
		Add find/replace all fonts feature	P141
		Add find/replace all strings feature	P142
		Add details of how to used find/replace string from text table feature	P145
		Add description for extended file recipe	
		1. File No./Name device	P4-58
		2. Block count device	P4-58
		3. Add data format setting description	P4-58
		Word Lamp	
		1. Increased word lamp conditional statements up to 64	P4-162
		2. Add copy&paste feature	P4-162
		3. Add only caption continuous copy feature	P4-166
		4. Add copy only property feature	P4-166
		Special Switch	
		1. Add multimedia special switch	
		2. Explorer and Editor: File Explorer – Add Write selected file name in to the device, Copy to specified path feature	
		3. Explorer and Editor: Add extended file Recipe explorer details.	
		4. Add password mode locked on screen.	
		5. Add multimedia on operation device	
		6. Add note for multimedia.	
		Word Message	
		1. Add message number and text table number features.	
		Realtime Scatter Graph	
		1. Add line type	
		File Explorer	
		1. Add initial path	
		2. Add extended file recipe features.	

		Add multimedia object Add explorer gesture feature Add screen change gesture option.	
V3.00	'19.10	<ol style="list-style-type: none"> 1. XP series not supported in V3.00 because of discontinued 2. Add font size unit feature 3. Add features about XP-Runtime 4. Add USB barcode feature 5. Add discontinued project conversion feature 6. Add keyboard input tags 7. Add create logging no. directory feature 8. Add delimiter feature 9. Add description on screen change switch 10. Add notes about appendix 5. 11. Add include path description 12. Add description of close window 13. Add scale type of device and constant 14. Add description on input max value 15. Add features of change status color 16. Add NC program monitor feature 17. Add Object Display Rule before Communication Connection 	<p>P1-12</p> <p>P2-22</p> <p>P2-28</p> <p>P2-34</p> <p>P2-188</p> <p>P4-8</p> <p>P4-24</p> <p>P4-56</p> <p>P4-197</p> <p>P4-218</p> <p>P4-225</p> <p>P4-264, 4-294</p> <p>P4-304</p> <p>P4-403</p> <p>App-40</p> <p>App-70</p>
V3.10	'20.03	<ol style="list-style-type: none"> 1. Image Update, words and misspelling correction 2. 2.2.2.9 Add Smooth edges of font feature 3. 2.2.2.10 Modified USB Barcode reader 4. 2.3.5.1 Improved object select feature 5. 2.6.6.7 Modified Viewing cross reference feature 6. 4.1.1 Add HS0503.1 VNC Server Control Tag 7. 4.1.2 Increased number of text table items 8. 4.1 Modified Common Data switch object display 9. 4.3.8.2 Add improvement of Pie graph feature 10. 4.3.22 Add FTP Client feature 	
V3.10	'20.05	Revision due to the change of company name	
V3.20	'20.08	<ol style="list-style-type: none"> 2.3.5.4 Multicopy: Add caption copy feature 4.1.3 Logging: Add CSV+PDF feature 4.3.4 Numeric/Text Display: Modified numeric display scaling feature Appendix 3: Add Autoscan feature 	
V3.40	'21.02	<ol style="list-style-type: none"> Add eXP 2 series Add Time Synchronization Add Slider Control object Add space feature to switch/lamp object 	

		Add number of decimal digits read from the device Add a feature to specify the text format of the numeric display from the text table Add selecting text format from the text table Add feature of setting global window position Improved project print Increased global script
V3.50	'21.10	1. Add Device Synchronization 2. Add History Alarm Viewer blink property 3. Add wXP offline property

V3.50, 2021.10

Revision History	i
1. About XP-Builder	1
1.1 Overview	1
1.1.1 <i>XP-Builder Concept</i>	1
1.1.2 <i>Supported Hardware Types</i>	2
1.2 Installing and Updating	3
1.2.1 <i>Installing XP-Builder</i>	3
1.2.2 <i>Updating XP-Builder</i>	4
1.3 Interface and Features	5
1.3.1 <i>The XP-Builder Interface</i>	5
1.3.2 <i>Controls and Options</i>	9
1.3.2.1 <i>Customizing Toolbars</i>	9
1.3.2.2 <i>Customizing Keyboard Shortcuts</i>	11
1.3.2.3 <i>Customizing Menu Options</i>	12
1.3.2.4 <i>Customizing Pane Positions</i>	12
1.3.2.5 <i>Customizing Other Options</i>	13
2. Project Development	1
2.1 Creating a project	1
2.1.1 <i>Starting a New Project</i>	1
2.1.2 <i>Saving a Project</i>	7
2.2 Configuring Project Properties	8
2.2.1 <i>Protecting the Project with a Password</i>	8
2.2.2 <i>Viewing and Editing Properties</i>	10
2.2.2.1 <i>Changing Basic Project Properties</i>	11
2.2.2.2 <i>Changing XGT Panel Settings</i>	12
2.2.2.3 <i>Changing Screen Settings</i>	15
2.2.2.4 <i>Changing Security Settings</i>	18
2.2.2.5 <i>Changing Key Window Settings</i>	20
2.2.2.6 <i>Changing Languages</i>	21
2.2.2.7 <i>Changing Storage Settings</i>	25
2.2.2.8 <i>Changing Global Script Settings</i>	27
2.2.2.9 <i>Changing Extended Device Settings</i>	28
2.2.2.10 <i>Changing Operation Log Settings</i>	33
2.2.2.11 <i>wXP Settings</i>	36
2.2.2.12 <i>Time Synchronization Settings</i>	37
2.2.2.13 <i>Device Synchronization Settings</i>	38
2.2.2.14 <i>Changing Auxiliary Settings</i>	40
2.2.3 <i>Editing default settings</i>	44
2.2.3.1 <i>Changing default editing options</i>	44
2.2.3.2 <i>Changing default project options</i>	45
2.3 Developing an Interface	47
2.3.1 <i>Adding Screens</i>	48
2.3.2 <i>Configuring Screens</i>	49
2.3.2.1 <i>Opening or Closing a Screen</i>	49
2.3.2.2 <i>Setting a Screen as the Start Screen</i>	49
2.3.2.3 <i>Renaming a Screen</i>	50
2.3.2.4 <i>Changing Screen Properties</i>	52
2.3.3 <i>Editing Screens</i>	54

2.3.4	<i>Inserting Figures or Objects</i>	55
2.3.4.1	Drawing Figures	55
2.3.4.2	Inserting Images from the Graphic Library.....	59
2.3.4.3	Drawing Objects	60
2.3.4.4	Inserting Objects from the Object Library.....	63
2.3.5	<i>Editing Objects</i>	65
2.3.5.1	Selecting Objects	65
2.3.5.2	Grouping and Ungrouping Objects	67
2.3.5.3	Locking and Unlocking Objects	68
2.3.5.4	Copying Multiple Objects.....	70
2.3.5.5	Arranging Objects.....	73
2.3.5.6	Rotating Objects.....	74
2.3.5.7	Resizing or Relocating Objects.....	76
2.3.5.8	Setting Viewing Options	80
2.3.5.9	Registering Figures/Objects	86
2.3.5.10	Draw from Figure to Object.....	87
2.3.5.11	Deleting an Object/Objects	88
2.3.5.12	Undoing and Redoing a Change.....	89
2.3.5.13	Object & Text Format.....	89
2.3.6	<i>Creating Screen Tap Groups</i>	90
2.3.7	<i>Exporting and Importing Fonts</i>	91
2.3.8	<i>Exporting and Importing Screens</i>	92
2.3.8.1	Import Screen Dialog Box.....	96
2.3.9	<i>Printing a Project</i>	100
2.3.10	<i>Renaming a Tag to add as a New Tag</i>	101
2.3.11	<i>Setting HW Key for Handy on Screen</i>	104
2.3.12	<i>Print</i>	107
2.3.13	<i>Print Preview</i>	109
2.4	Managing Libraries	111
2.4.1	<i>Managing Graphic Libraries</i>	111
2.4.1.1	Creating a User Graphic Library	113
2.4.1.2	Exporting a User Graphic Library	116
2.4.1.3	Importing a User Graphic Library.....	117
2.4.1.4	Editing a User Graphic Library.....	119
2.4.1.5	Applying Options to the Images	121
2.4.2	<i>Managing Object Libraries</i>	126
2.4.2.1	Creating a User Object Library	127
2.4.2.2	Exporting a User Object Library.....	129
2.4.2.3	Importing a User Object Library.....	131
2.4.2.4	Editing a User Object Library.....	133
2.5	Connecting Controllers	135
2.5.1	<i>Connecting via an Ethernet Cable</i>	135
2.5.2	<i>Connecting via a Serial Port</i>	138
2.5.2.1	Using RS232C.....	138
2.5.2.2	Using RS485/RS422	141
2.6	Simulating & Debugging	144
2.6.1	<i>Simulating an Interface</i>	144
2.6.2	<i>Inputting Simulated Data</i>	147
2.6.2.1	Monitoring Devices.....	147
2.6.2.2	Changing Device Values	148

2.6.3	<i>Running a Data Check</i>	150
2.6.4	<i>Viewing the Device Map</i>	151
2.6.5	<i>Evaluating Project Size (Memory Usage)</i>	153
2.6.6	<i>Finding and Replacing Devices</i>	154
2.6.6.1	<i>Finding and Replacing Devices on the Active Screen</i>	154
2.6.6.2	<i>Finding and Replacing All Devices</i>	155
2.6.6.3	<i>Finding and Replacing All Fonts</i>	156
2.6.6.4	<i>Finding & Replacing All Strings</i>	158
2.6.6.5	<i>Finding and Replacing Devices, Fonts, and Tags from a List</i>	160
2.6.6.6	<i>Viewing Cross-References</i>	165
2.6.6.7	<i>Viewing Cross-References</i>	165
2.6.7	<i>Switching Project Screens</i>	165
2.7	Running XP-Simulators with other PLC Simulators	166
2.7.1	<i>XG5000 Simulator and XP Simulator</i>	166
2.7.2	<i>S7-PLCSIM Simulator and XP-Simulator</i>	168
2.7.3	<i>RSLogix Emulator and XP-Simulator</i>	170
2.7.4	<i>The GX Simulator and XP-Simulator</i>	177
2.8	Managing a Project	182
2.8.1	<i>Transferring to an XGT Panel</i>	182
2.8.1.1	<i>Using a Serial (RS-232C) Connection</i>	188
2.8.1.2	<i>Using an Ethernet Connection</i>	189
2.8.1.3	<i>Using a USB Connection (XP models)</i>	191
2.8.1.4	<i>Using a USB Connection (iXP/eXP/iXP2/eXP2 models)</i>	193
2.8.2	<i>Transferring to a Removable Device</i>	195
2.8.3	<i>Starting a Project File from a Local wXP</i>	197
2.8.4	<i>Receiving a Project File from an XGT Panel</i>	199
2.8.5	<i>Backing up Project Data</i>	201
2.8.6	<i>Discontinued Project Conversion</i>	203
2.9	Configuring Advanced Communication Settings	205
2.9.1	<i>Using 1: N Communication with Multiple Protocols</i>	205
2.9.2	<i>Using 1: N Communication with RS485/RS422</i>	206
2.9.3	<i>Using N: 1 Communication</i>	209
2.9.3.1	<i>Token Hold</i>	211
2.9.3.2	<i>N:1 System Devices</i>	212
2.9.4	<i>View Communication Manual</i>	212
3.	Error Messages	1
3.1	Resolving Error Codes Found in the Results Pane	1
3.2	Resolving Error Messages in Pop-up Windows	9
4.	Reference	1
4.1	Common Data	1
4.1.1	<i>Tags</i>	2
4.1.2	<i>Text Tables</i>	18
4.1.3	<i>Logging</i>	24
4.1.4	<i>Recipes</i>	40
4.1.4.1	<i>Basic Recipes</i>	40
4.1.4.2	<i>File Recipes</i>	51
4.1.4.3	<i>Extended File Recipe</i>	60
4.1.5	<i>Flow Alarms</i>	73

4.1.6 History Alarms	78
4.1.7 Schedules.....	93
4.1.8 Sounds	97
4.2 Scripts	99
4.2.1 About Scripts	99
4.2.1.1 Understanding Script Commands.....	101
4.2.1.2 Understanding Device Address Expressions	123
4.2.1.3 Understanding Constants and Data Types	124
4.2.1.4 Understanding Temporary Variables in a Script	127
4.2.1.5 Viewing the Script Cross Reference	129
4.2.2 Creating Scripts.....	131
4.2.2.1 Inserting Scripts.....	131
4.2.2.2 Using the Script Tool box	132
4.2.2.3 Specifying Local Scripts	133
4.2.2.4 Specifying Display Change Scripts.....	135
4.2.2.5 Specifying Scheduler Scripts	136
4.2.2.6 Creating Object Scripts.....	138
4.2.2.7 Editing Scripts	139
4.2.2.8 Understanding Script Error Handling	141
4.2.2.9 Understanding the Script Watchdog Function.....	141
4.2.3 Using Scripts to Control XGT Panel Functions.....	143
4.2.3.1 Understanding System Functions.....	143
4.2.3.2 Understanding Print Functions	144
4.2.3.3 Understanding Screen Change Functions	144
4.2.3.4 Understanding Script Functions.....	145
4.2.3.5 Understanding String Functions	146
4.2.3.6 Understanding Device Functions.....	147
4.2.3.7 Understanding Communication Functions	149
4.2.3.8 Understanding Memory Functions	151
4.2.3.9 Understanding Data Conversion Functions	153
4.2.3.10 Understanding Other Functions.....	155
4.3 Objects	157
4.3.1 Lamp Objects	159
4.3.1.1 Bit Lamp.....	159
4.3.1.2 Word Lamp.....	166
4.3.1.3 N-State Lamp	176
4.3.2 Switch Objects.....	183
4.3.2.1 Bit Switch	183
4.3.2.2 Word Switch	191
4.3.2.3 Change Screen Switch	202
4.3.2.4 Special Switch.....	211
4.3.2.5 Multi Switch	240
4.3.3 Message Objects.....	249
4.3.3.1 Bit Message	249
4.3.3.2 Word Message	254
4.3.4 Numeric/Text Objects	264
4.3.4.1 Numeric Input.....	264
4.3.4.2 Numeric Display	284
4.3.4.3 Text Input.....	296
4.3.4.4 Text Display	304

4.3.5	<i>Window Objects</i>	310
4.3.5.1	Bit Window	310
4.3.5.2	Word Window	313
4.3.6	<i>Part Objects</i>	318
4.3.6.1	Bit Part	320
4.3.6.2	Word Part	324
4.3.7	<i>Animation Object</i>	332
4.3.8	<i>Graph Objects</i>	334
4.3.8.1	Bar Graph.....	334
4.3.8.2	Pie Graph.....	340
4.3.8.3	Meter Graph	347
4.3.8.4	Closed Graph	352
4.3.8.5	Trend Graph	358
4.3.8.6	Logging Trend Graph.....	368
4.3.8.7	Scatter Graph – Logging Scatter	381
4.3.8.8	Scatter Graph - Realtime Scatter.....	389
4.3.9	<i>History Alarm Viewer Object</i>	399
4.3.10	<i>Data List Object</i>	409
4.3.11	<i>Logging Viewer Object</i>	414
4.3.12	<i>Alarm Navigator Object</i>	424
4.3.13	<i>Explorer</i>	426
4.3.14	<i>Data List Editor Object</i>	432
4.3.15	<i>File Recipe Editor Object</i>	437
4.3.16	<i>Clock Object</i>	441
4.3.17	<i>Embedded Screen Object</i>	445
4.3.18	<i>Memo Pad Object</i>	448
4.3.19	<i>PDF Viewer Object</i>	450
4.3.20	<i>VNC Viewer Object</i>	451
4.3.21	<i>Multimedia object</i>	452
4.3.22	<i>FTP Client</i>	455
4.3.23	<i>Slider</i>	461
4.4	Viewing or Changing XGT Panel Information	466
4.5	Using the HTML Device Copier	469
4.6	Using the CSV Converter	471
4.7	Managing External Storage Sources for Backup	472
4.7.1	<i>Managing the File Path for Backup Files</i>	472
4.7.1.1	File Path for Logging Backup.....	473
4.7.1.2	Path for Recipe Backup.....	474
4.7.1.3	Path for Screen Backup.....	474
4.7.1.4	Path for Memo Backup	475
4.7.2	<i>Managing Memory for Backups</i>	476
4.7.2.1	When there is Insufficient Memory or Exceeds the Limit.....	476
4.7.3	<i>Monitoring External Storage Connection</i>	478
4.7.4	<i>Safe Removal Switch</i>	480
5.	Other features	1
5.1	Gestures & Multi-Touch	1
5.1.1	<i>Gesture definition</i>	1
5.1.2	<i>Screen Transition Gesture Function</i>	1

5.1.3 Logging Trend Graph Gesture Function	1
5.1.4 Logging View Gesture Function.....	2
5.1.5 History Alarm View Gesture Function	3
5.1.6 Explorer/FTP Client gesture function.....	3
5.1.7 Multi-touch function	4
5.1.8 Screen change gesture options.....	5
5.1.9 Gesture function On/Off.....	6
Appendix.....	1
1 Program Monitor.....	1
1.1 About Program Monitor.....	1
1.1.1 PLCs that Support Monitoring.....	1
1.1.2 Properties by HMI devices.....	3
1.1.3 The Program Monitor Window	4
1.2 Monitoring Program.....	6
1.2.1 Monitoring Programs from the XGT Panel Menu	6
1.2.2 Monitoring Programs with a Special Switch Object.....	6
1.2.3 Selecting Programs to Monitor	7
1.2.4 Managing Programs	9
1.2.5 Viewing the Monitoring Data.....	10
1.2.6 Changing the Display Format	11
1.2.7 Changing the Current Device Value.....	12
1.3 Monitoring Devices	15
1.3.1 Managing Devices.....	15
1.4 Using the Search Functions.....	19
1.4.1 Searching for Devices	19
1.4.2 Searching for Labels	26
1.4.3 Searching for Sub-routines.....	27
1.4.4 Searching for Steps.....	28
1.4.5 Searching with Touch	30
1.4.6 Searching for Labels with Touch.....	30
1.4.7 Searching for Sub-routines with Touch	33
1.4.8 Searching for Devices with Touch.....	35
1.5 Configuring Options.....	38
2 NC Program Monitor.....	40
2.1 Start.....	40
2.2 Run at wXP.....	42
2.3 NC Monitoring Program Features.....	43
2.3.1 NC monitoring program description	43
2.3.2 User Device Setting.....	44
2.3.3 NC file Management.....	44
2.3.4 Import NC file	46
2.3.5 Change View Mode	47
2.4 Edit NC Program	48
2.4.1 Preparation.....	48
2.4.2 Overview	50
3 Autoscans	52
3.1 Start Autoscans	52
3.1.1 Overview	52
3.1.2 Add special switch to operate Autoscans program.....	53

3.2 Using in wXP	54
3.3 Features of Autoscan.....	56
3.3.1 Autoscan program menu	56
3.3.2 IP setting and monitoring period setting.....	57
3.3.3 Save network status	58
3.3.4 Slave Diagnostic.....	59
3.3.5 Goto Local.....	59
3.3.6 Compare	60
3.3.7 Cable Distance	60
3.3.8 Monitoring	61
3.3.9 Remote module status information diagnostic	62
4 XP-VSP	69
4.1 About XP-VSP	69
4.1.1 Overview	69
4.1.2 Supported PLC Drivers.....	71
4.2 Installing and Updating	72
4.2.1 Installing XP-VSP	72
4.2.2 Updating XP-VSP.....	73
4.3 Interfaces and Features.....	74
4.4 Using XP-VSP	74
4.4.1 Registering Virtual Com Port	75
4.4.2 Connecting PLC and Ladder Program via Virtual Com Port.....	78
4.4.3 Unregistering Virtual Com Port	79
4.5 Editing Default Settings	80
5 wXP	81
5.1 About wXP.....	81
5.1.1 Requirements.....	81
5.2 wXP Interface	82
5.2.1 Project.....	82
5.2.2 Screen.....	83
5.2.3 Offline Setting.....	83
5.2.4 Help.....	86
5.3 wXP Restrictions.....	87
6 Object Display Rule before Communication Connection	88
7 Glossary	89
8 List of Acronyms	92
9 Caution	93

1. About XP-Builder

XP-Builder is software that allows you to create and manage projects for machine control devices. You can use XP-Builder to create projects for the XGT Panel. XP-Builder includes multiple features that allow you to design and edit projects conveniently, such as:

- Customizable toolbars and hotkeys
- Customizable tool, project, and editing panes
- Functions to import and export common data
- Tabs for viewing multiple screens easily
- Previews of project screens
- Customizable image and object libraries
- Scripts and advanced functions, such as alarms, logs, schedules, and recipes
- Support for multiple languages

1.1 Overview

This section describes the basic concept of using XP-Builder to create interfaces for machine control devices and the types of hardware that XP-Builder supports.

1.1.1 XP-Builder Concept

XP-Builder is the starting point for creating human-machine interfaces (HMIs) for industrial applications. With XP-Builder, you can design user-friendly interfaces for XGT Panels that allow end users to control machine functions through configurable controllers, such as programmable logic controllers (PLCs), inverters, or servos.

With the XGT Panel, you can monitor information from each controller via a graphical user interface (GUI). In addition, simple control is possible with switch and writing objects. The XGT Panel supports additional programmable functions, such as scripts, loggings, recipes, and alarms, which allow you to fully customize the control environment.

As illustrated by the graphic that follows, the interface running on an XGT Panel provides input controls on the screen in the form of GUI objects that are linked to controller routines, such as a ladder program, or other parameters. The controller parameters dictate the operation of connected machinery and may also provide feedback to the XGT Panel.

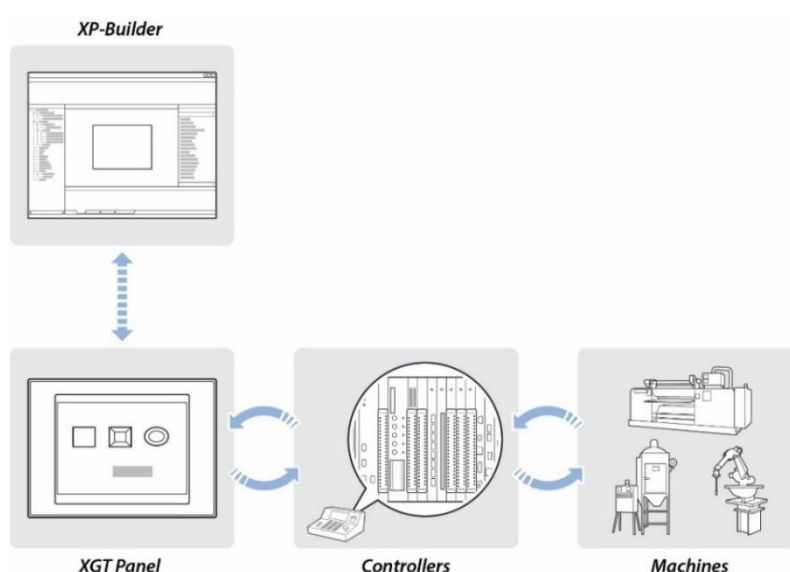

1.1.2 Supported Hardware Types

XP-Builder supports XP, iXP, eXP and IPC series XGT Panels and a wide range of controllers. Projects can only be transferred from XP-Builder to XGT Panel. To view specifications for XGT Panels, in XP-Builder, click [PROJECT] ► [New Project], and then select a series and model number from the drop-down lists.

The screenshot shows the 'New Project' dialog box with the following configuration:

- Series:** iXP2 Series
- Model:** iXP2-0800
- Portrait Mode

Specifications:

Screen size:	8.4 Inch	Serial IF:	RS-232C
Resolution:	800 x 600 Pixels	Serial IF:	RS-232C/RS-422(RS-485)
LCD:	TFT Color LCD	USB:	4 Port
Color:	16777216 Colors	CF card:	None
Memory:	128 MB	SD card:	On
HDMI:	1 Port	LAN:	2 Port

Controller:

- Vendor:** LS
- Product:** LS: XGK (LINK)

Buttons:

Note

- Available memory for XP series XGT Panels is 10 MB for TTA and BTA models, with the exception of the XP90 model (20 MB), and 4 MB for TTE and BTE models.
- 64 MB memory is available for eXP XGT Panels, and 128 MB for iXP/IPC series XGT Panels.
- **XP Series is not supported on XP-Builder V3.00.** If you want to use XP series, please use previous version of XP-Builder V3.00

1.2 Installing and Updating

This section explains how to install and update the XP-Builder software, as well as the operating system software for an XGT Panel.

1.2.1 Installing XP-Builder

You may install XP-Builder on a PC that meets the following minimum system requirements:

- Processor: Pentium 4 or higher
- Memory: 512MB or more free memory
- COM Ports: RS-232C serial port, Ethernet port, or USB port
- Hard Disk: 1GB capacity or higher
- Monitor: Minimum resolution of 1024x768
- OS: Windows Vista, Windows 7, Windows 8, or Windows 10
- Peripherals: Mouse and keyboard

To install XP-Builder in Windows XP:

- 1** Run the XP-Builder setup file. You can download the file from the LS ELECTRIC website (<https://www.ls-electric.com/support/download-center>).
- 2** Select an installation language (Chinese [Simplified], English, Japanese or Korean).
- 3** Follow the instructions in the installation wizard to complete the installation.

To install XP-Builder in Windows Vista:

- 1** Log in to your computer with an administrator account.
- 2** On your computer, click [Start] ► [Control Panel] ► [User Accounts and Family Safety].
- 3** Click [User Accounts] ► [Turn User Account Control on or off], and uncheck the checkbox next to **Use User Account Control (UAC)** to help protect your computer.
- 4** Run the XP-Builder setup file. You can download the file from the LS ELECTRIC website (<https://www.ls-electric.com/support/download-center>).
- 5** Select an installation language (Chinese [Simplified], English, Japanese or Korean).
- 6** Follow the instructions in the installation wizard to complete the installation.

To install XP-Builder in Windows 7 or Windows 8:

- 1 Log in to your computer with an administrator account.
- 2 On your computer, click [Start] ► [Control Panel] ► [User Accounts and Family Safety].
- 3 Click [User Accounts] ► [Change User Account Control Settings], and drag the slider to never notify.
- 4 Run the XP-Builder setup file. You can download the file from the LS ELECTRIC website (<https://www.ls-electric.com/support/download-center>).
- 5 Select an installation language (Chinese [Simplified], English, Japanese or Korean).
- 6 Follow the instructions in the installation wizard to complete the installation.

To install XP-Builder in Windows 10:

- 1 Log in to your computer with an administrator account.
- 2 Run the XP-Builder setup file. You can download the file from the LS ELECTRIC website (<https://www.ls-electric.com/support/download-center>).
- 3 Select an installation language (Chinese [Simplified], English, or Korean).
- 4 Follow the instructions in the installation wizard to complete the installation.

1.2.2 Updating XP-Builder

To check the version of your XP-Builder software, click [HELP] ► [About XP-Builder]. To update XP-Builder, refer to the LS ELECTRIC website (<https://www.ls-electric.com/support/download-center>).

Note

You can update an XGT Panel automatically in XP-Builder version 1.30 or higher. If you use a version lower than 1.24, you must update the XGT Panel manually.

1.3 Interface and Features

XP-Builder offers a wide range of customizable options that allow you to efficiently create and manage projects. This section describes the XP-Builder interface and explains how to customize it to suit your needs.



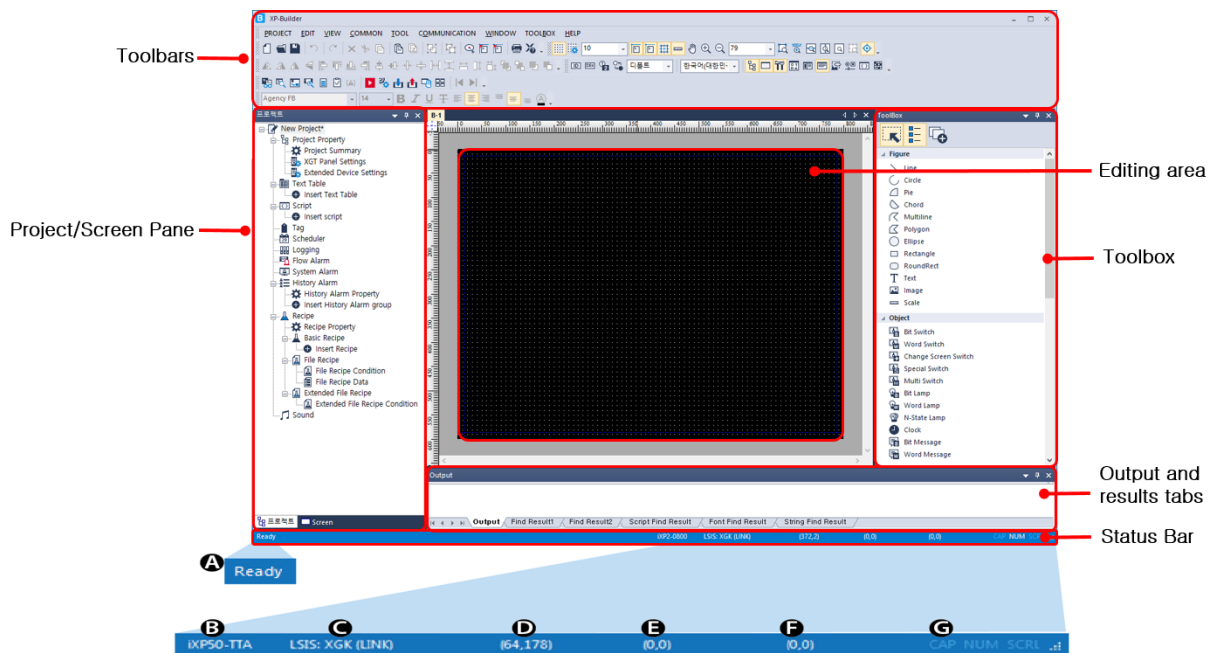

1.3.1 The XP-Builder Interface

The XP-Builder interface is similar to that of many Windows-based programs. You can customize the interface by selecting various toolbar and window options, as described in **<1.3.2 Controls and Options>**.

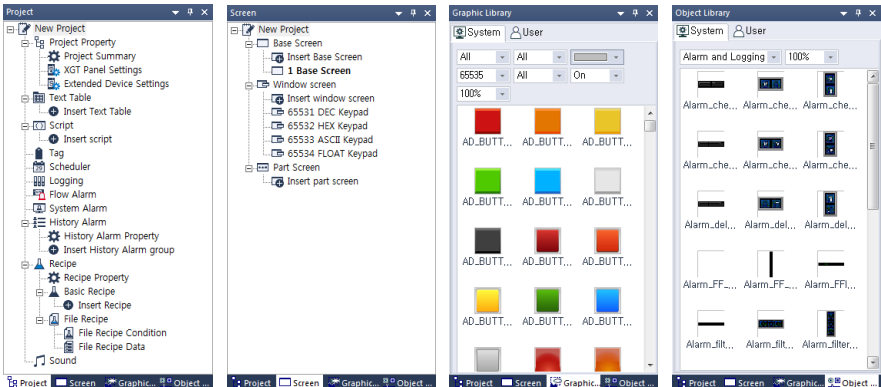

Main Interface:

Interface	Description
Toolbars	Use tools or menus to perform tasks and specify options.
Project/ Screen Pane	The Project pane shows the elements contained in the project in a cascading tree, or shows the screens by screen type in a cascading tree. The Screen pane shows all the screens used included in the current project. You can add or edit each component from these panes.

Interface	Description																
	 <p><Project pane> <Screen pane> <Graphic Library pane> <Object Library pane></p> <p>You can open, reposition, or dock other windows, such as the Graphic Library, Object Library, Device Map, Script Toolbox, and Data Viewer windows. You can also select Data Viewer, Graphic library, and Object library from the VIEW menu to open them in the pane.</p>																
Editing area	The center of the window, where you can add and manipulate objects, figures, and images to create an interface.																
Toolbox	<p>Use the Toolbox to create, view and modify a project. Project Viewer and Screen Viewer are displayed by default when you first run the software.</p> <ul style="list-style-type: none"> • By default, figures and objects are displayed in the pane as small images. To view figures or objects in a tree type list, select [TOOLBOX] ► [Tree Type ToolBox] or select  in the ToolBox pane. • By default, figures  and objects are set to Single Insert Mode, which allows you to insert one figure or object at a time. To insert figures or objects continuously, select [TOOLBOX] ► [Continuous Insert Mode] or select  in the ToolBox pane. 																
Output and results tabs	These tabs allow you to view interface messages, error messages, and search results.																
Status bar	<p>The status bar displays additional project-related information.</p> <table border="1" data-bbox="507 1467 1385 1865"> <thead> <tr> <th data-bbox="507 1467 608 1518"></th> <th data-bbox="608 1467 1385 1518">Description</th> </tr> </thead> <tbody> <tr> <td data-bbox="507 1518 608 1570">A</td> <td data-bbox="608 1518 1385 1570">System message</td> </tr> <tr> <td data-bbox="507 1570 608 1621">B</td> <td data-bbox="608 1570 1385 1621">Panel type</td> </tr> <tr> <td data-bbox="507 1621 608 1673">C</td> <td data-bbox="608 1621 1385 1673">Controller type</td> </tr> <tr> <td data-bbox="507 1673 608 1724">D</td> <td data-bbox="608 1673 1385 1724">Cursor position</td> </tr> <tr> <td data-bbox="507 1724 608 1776">E</td> <td data-bbox="608 1724 1385 1776">Object position (top left)</td> </tr> <tr> <td data-bbox="507 1776 608 1827">F</td> <td data-bbox="608 1776 1385 1827">Object size: Width/height</td> </tr> <tr> <td data-bbox="507 1827 608 1865">G</td> <td data-bbox="608 1827 1385 1865">Caps lock/number lock/scroll lock status</td> </tr> </tbody> </table>		Description	A	System message	B	Panel type	C	Controller type	D	Cursor position	E	Object position (top left)	F	Object size: Width/height	G	Caps lock/number lock/scroll lock status
	Description																
A	System message																
B	Panel type																
C	Controller type																
D	Cursor position																
E	Object position (top left)																
F	Object size: Width/height																
G	Caps lock/number lock/scroll lock status																

Note

Screens in XP-Builder Projects

Screens contain objects and figures that XP-Builder provides. There are three different types of

screens available:

- **Base screens** allow users to edit the objects and figures. Base screens have fixed screen sizes and color specifications based on the panel types.

Panel type	XGT Panel model names	Screen size and color spec.
XP	XP30-BTA	320 X 240 px, 8 Grayscale colors
	XP30-TTA	320 X 240 px, 65,000 colors
	XP30-BTE	320 X 240 px, 8 Grayscale colors
	XP30-TTE	320 X 240 px, 256 colors
	XP40-TTE	800 X 480 px, 65,536 colors
	XP40-TTA	800 X 480 px, 65,536 colors
	XP50-TTE	640 X 480 px, 256 colors
	XP50-TTA	640 X 480 px, 65,000 colors
	XP70-TTA	640 X 480 px, 65,000 colors
	XP80-TTA	800 X 600 px, 65,000 colors
	XP90-TTA	1024 X 768 px, 65,000 colors
iXP	iXP50-TTA	800 X 600 px, 16.7M colors
	iXP70-TTA	800 X 600 px, 16.7M colors
	iXP80-TTA	800 X 600 px, 16.7M colors
	iXP90-TTA	1024 X 768 px, 16.7M colors
iXP2	iXP2-0800	800 X 600 px, 16.7M colors
	iXP2-1000	1024 X 768 px, 16.7M colors
	iXP2-1200	1024 X 768 px, 16.7M colors
	iXP2-1500	1024 X 768 px, 16.7M colors
	iXP2H-0702D	1024 X 600 px, 16.7M colors
	iXP2H-0704D	1024 X 600 px, 16.7M colors
eXP	eXP20-TTA	480 X 272 px, 16.7M colors
	eXP30-TTA	680 X 480 px, 65,536 colors
	eXP30-TTE	680 X 480 px, 65,536 colors
	eXP40-TTA	800 X 480 px, 16.7M colors
	eXP40-TTE	800 X 480 px, 16.7M colors
	eXP60-TTA	800 X 480 px, 65,536 colors
eXP2	eXP2-0400	480 X 272 px, 16.7M colors
	eXP2-0500	640 X 480 px, 262,144 colors

IPC(wXP)	eXP2-0502	640 X 480 px, 262,144 colors
	eXP2-0700	800 X 480 px, 16.7M colors
	eXP2-0701	800 X 480 px, 16.7M colors
	eXP2-0702	800 X 480 px, 16.7M colors
	eXP2-1000	1024 X 600 px, 16.7M colors
	eXP2-1001	1024 X 600 px, 16.7M colors
	AT/PC	User-designated attribute (Width/Height: 200–3840) 16.7M colors

- **Window screens** are used for displaying Window screens over a Base screen.
- **Part screens** are used as parts for Bit or Word Part objects.

1.3.2 Controls and Options

Customize toolbars, keyboard shortcuts, menus, and other options in the XP-Builder interface.

1.3.2.1 Customizing Toolbars

In the XP-Builder interface, you can create custom toolbars, add or remove icons on toolbars, and select which toolbars to show.

To create a toolbar:

- 1 Click [TOOL] ► [Customization] ► [Toolbars].

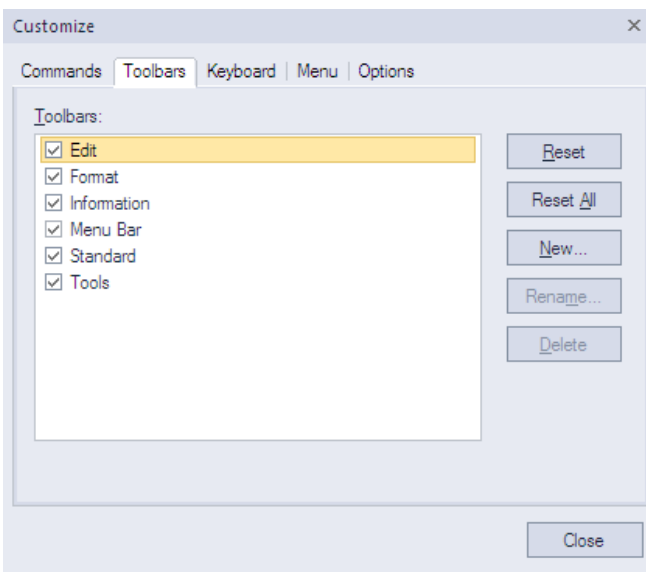

- 2 Click [New].

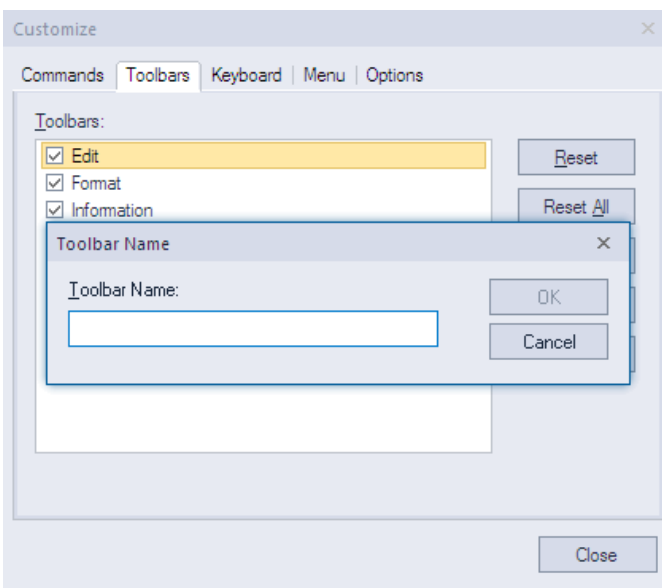

- 3** Enter a name for the toolbar and click [OK]. The new toolbar will be added to the list of available toolbars on the left of the Customize window. You can drag icons from the toolbars at the top of the XP-Builder window to the new toolbar.

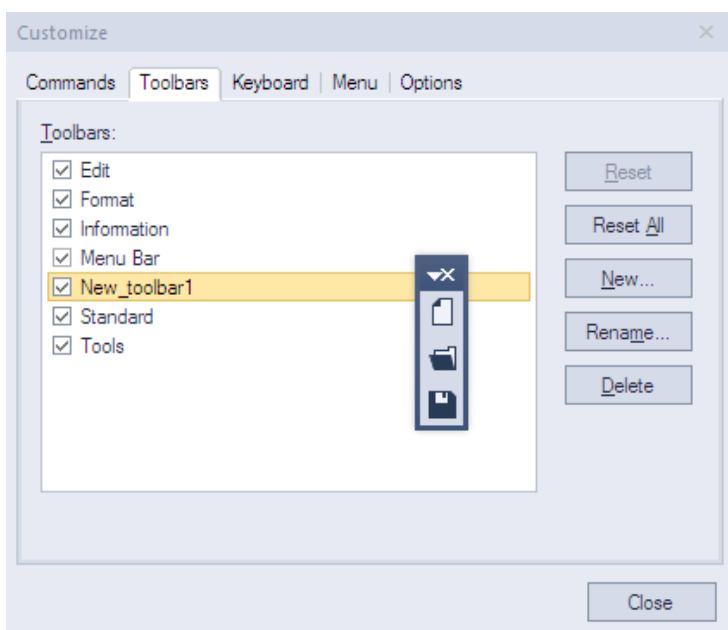

To add or remove icons on toolbars:

- 1** Click [TOOL] ► [Customization] ► [Commands].

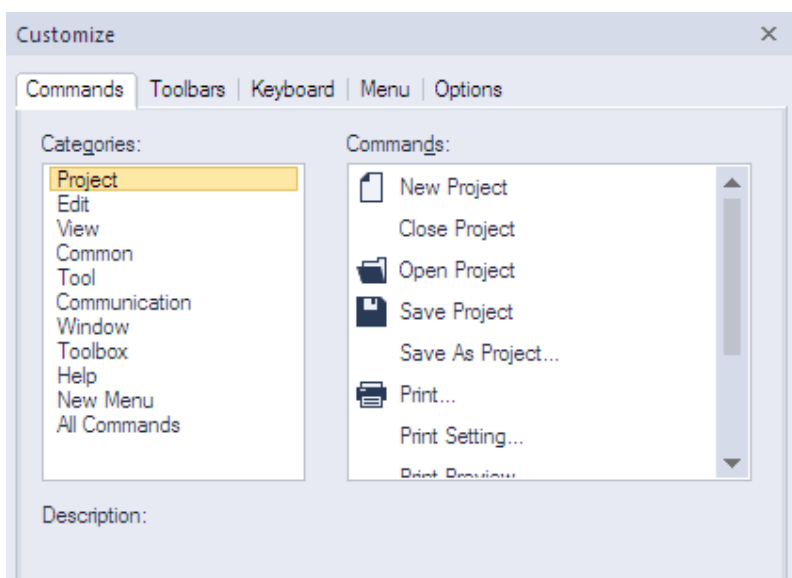

- 2** Click a tool category on the left, and then drag and drop a command onto an existing toolbar. Or, to remove an icon, drag it from a toolbar to the Customize window.

To select which toolbars to show:

- 1 Click [TOOL] ► [Customization] ► [Toolbars].

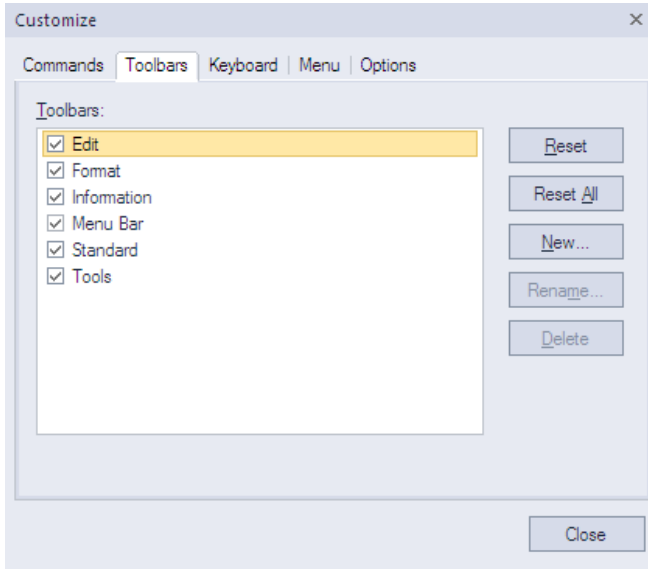

- 2 Check the checkboxes to the left of the toolbars to select which to show (checked) and which to hide (unchecked).

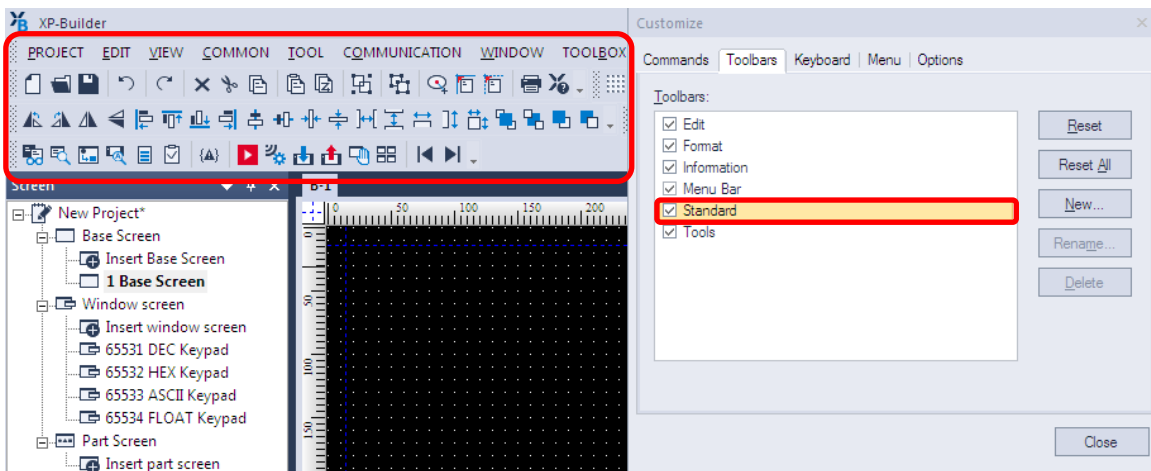

1.3.2.2 Customizing Keyboard Shortcuts

To customize keyboard shortcuts (hotkeys):

- 1 Click [TOOL] ► [Customization] ► [Keyboard].
- 2 Click a tool category from the drop-down list, and then click a command.
- 3 Click the **Press New Shortcut** field and then press a key combination on the keyboard. If you press a combination that is already in use, the action that is assigned to the shortcut will appear below this field.

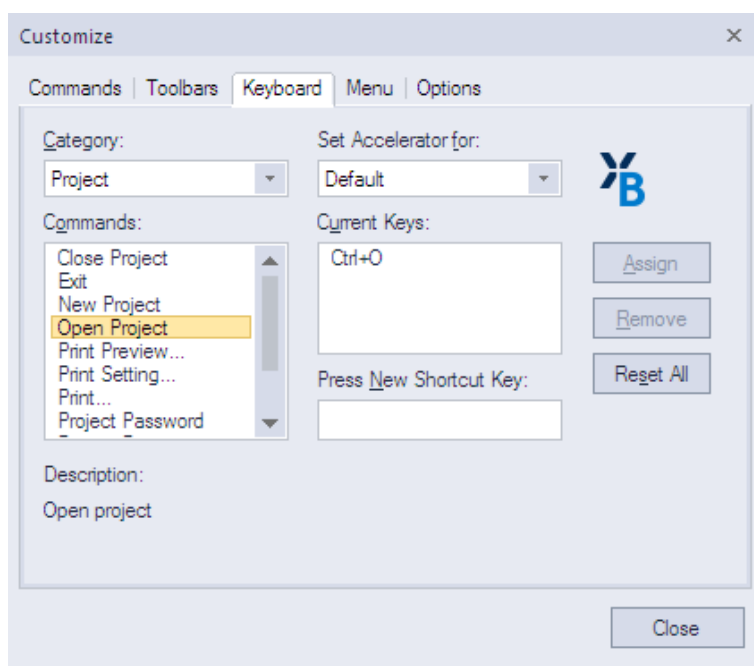

- 4 Click [Assign].
- 5 To remove a shortcut, select one from the **Current** field and then click [Remove].
- 6 When you are finished customizing keyboard shortcuts, click [Close].

1.3.2.3 Customizing Menu Options

In the Customize window, you can select which Application Frame windows and Context menus to show. To customize menu options, click [TOOL] ► [Customization] ► [Menu], and then select the desired options from the drop-down menus.

1.3.2.4 Customizing Pane Positions

To view or hide panes, click [VIEW], and then click the name of a pane. You can drag and drop panes in new positions within the XP-Builder window. To change the properties of a pane, right-click the pane and click an option. You can set panes to dock or float, and set whether or not the pane will hide automatically.

To dock the pane, move the pane to the desired location indicator. A shadow will appear to provide a preview of the docking location.

To set a pane to float, on the pane, click  ► [Floating]. To hide a pane, on the pane, click .

1. About XP-Builder

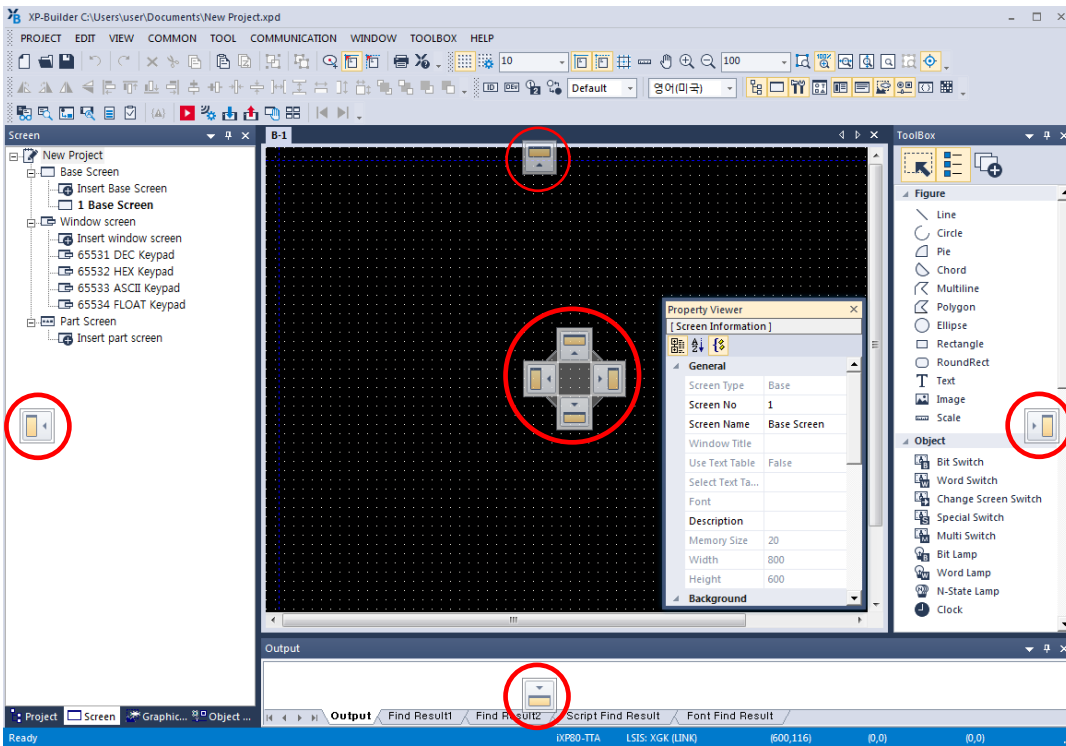

1.3.2.5 Customizing Other Options

In the Customize window, you can customize additional options, such as whether or not to show tooltips and show shortcuts with tips. To customize these options, click [TOOL] ► [Customization] ► [Options], and then check the checkboxes next to the desired options.

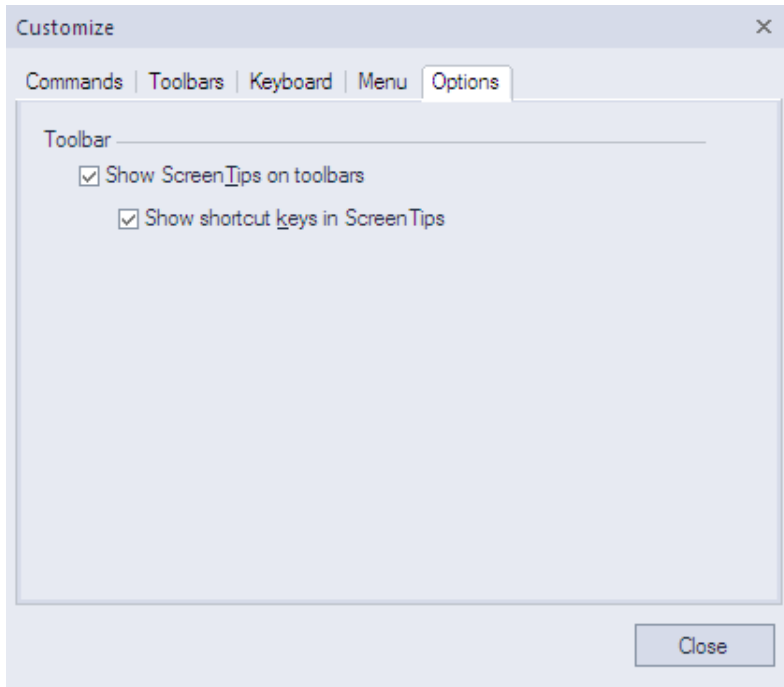

2. Project Development

XP-Builder allows you to develop complex but simple-to-use interfaces for controlling machines. You can add figures, objects, and graphics to represent functions, or use scripts to define processes. XP-Builder also allows you to simulate projects and debug them before transferring them to an XGT Panel.

2.1 Creating a project

Learn how to start or open a project.

2.1.1 Starting a New Project

To create a new project:

- 1 When you launch XP-Builder, the Select Project window appears. Click [Create Project] to create a project.



- To open a saved file, select [Open Project].
- To enable the Select Project window to appear every time you launch XP-Builder, check the checkbox next to **Show this Dialog at Startup**.
- You can also create a file by selecting [PROJECT] ► [New Project].

Note

- XP-Builder supports multiple instances of the software running simultaneously. Users can run more than one XP-builder window on a PC to edit projects more efficiently.
- If you try to save a read-only project file, XP-builder displays the error message below.

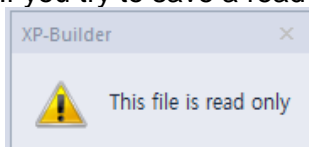

- If you try to open a project file that is already open in another editor, XP-builder displays the error message below.

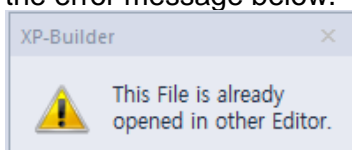

2 Set the panel series, model name, the controller manufacturer, and the controller model (Product).

3 If necessary, click [Communication Settings] and specify connection properties. For more details about connection properties, refer to [<2.5 Connecting Controllers>](#).

4 Click [Finish] or [OK].

Note

- XGT Panel series panels come in various models featuring different screen resolutions, display colors, and other hardware configurations.

[XP Series]

Model Type	Screen Resolution	Colors	External Storage device	Ethernet
XP30-TTA	320 X 240	65,000	1 X 1 X CF, 2 X USB	O
XP30-BTE	320 X 240	8	1 X USB	X
XP30-BTA	320 X 240	8	1 X CF, 2 X USB	O
XP30-TTE	320 X 240	256	1 X USB	X
XP40-TTA	800 X 600	65,536	1 X USB	O
XP40-TTE	800 X 600	256	1 X USB	X
XP50-TTA	640 X 480	65,000	1 X CF, 2 X USB	O
XP50-TTE	640 X 480	256	1 X USB	X
XP70-TTA	640 X 480	65,000	1 X CF, 2 X USB	O
XP80-TTA	800 X 600	65,000	1 X CF, 2 X USB	O

XP90-TTA	1024 X 768	65,000	1 X CF, 2 X USB	O
----------	------------	--------	-----------------	---

[iXP Series]

Model Type	Screen Resolution	Colors	External Storage device	Ethernet
iXP50-TTA	800 X 600	65,536	3 X USB, 1 X SD card slot	O
iXP70-TTA	800 X 600	65,536	3 X USB, 1 X SD card slot	O
iXP80-TTA	800 X 600	65,536	3 X USB, 1 X SD card slot	O
iXP90-TTA	1024 X 768	65,536	3 X USB, 1 X SD card slot	O

[iXP2 Series]

Model Type	Screen Resolution	Colors	External Storage device	Ethernet
iXP2-0800	800 X 600	16.7M	3 X USB, 1 X SD	O
iXP2-1000	1024 X 768	16.7M	3 X USB, 1 X SD	O
iXP2-1200	1024 X 768	16.7M	3 X USB, 1 X SD	O
iXP2-1500	1024 X 768	16.7M	3 X USB, 1 X SD	O
iXP2H-0702D	1024 X 600	16.7M	1 X USB, 1 X SD	O
iXP2H-0704D	1024 X 600	16.7M	1 X USB, 1 X SD	O

[eXP Series]

Model Type	Screen Resolution	Colors	External Storage device	Ethernet
eXP20-TTA	480 X 272	16.7M	1 X USB	O
eXP30-TTA	680 X 480	65,536	1 X USB	O
eXP30-TTE	680 X 480	65,536	1 X USB	X
eXP40-TTA	800 X 480	16.7M	1 X USB	O
eXP40-TTE	800 X 480	16.7M	1 X USB	X
eXP60-TTA	800 X 480	65,536	1 X USB	O

[eXP2 Series]

Model Type	Screen Resolution	Colors	External Storage device	Ethernet
eXP2-0400	480 X 272	16.7M	1 X USB	O
eXP2-0500	640 X 480	65,536	1 X USB	O
eXP2-0502	640 X 480	65,536	1 X USB	X
eXP2-0700	800 X 480	16.7M	1 X USB	O
eXP2-0701	800 X 480	16.7M	1 X USB, 1 X MircoSD	O
eXP2-0702	800 X 480	16.7M	1 X USB	X
eXP2-1000	1024 X 600	16.7M	1 X USB	O
eXP2-1001	1024 X 600	16.7M	1 X USB, 1 X MircoSD	O

[IPC Series]

Model Type	Screen Resolution	Colors	External Storage device	Ethernet
PC/AT	Customizable	16.7M	Varies by PC	O

- IPC can set any value in resolution.
For example, 800x600, 1024x760, and so one.
You can set the resolution from 200x200 to 3840x3840.

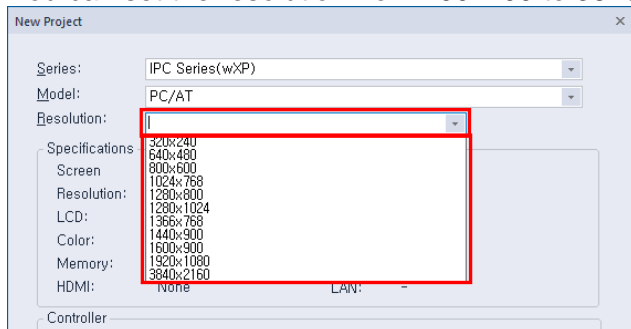

- XP-Builder allows model type changes to other panel models with the same or higher color specifications. However, XP-Builder does not allow project conversion from color to monochrome XGT Panels, or vice versa.
- BTE and TTE type models support only BMP, GIF, JPG, and WMF image file formats. Run a data check to ensure that only the supported image types are used in a project.
- You can view a summary of XGT Panel specifications when you create a project by selecting the XGT Panel series and model.

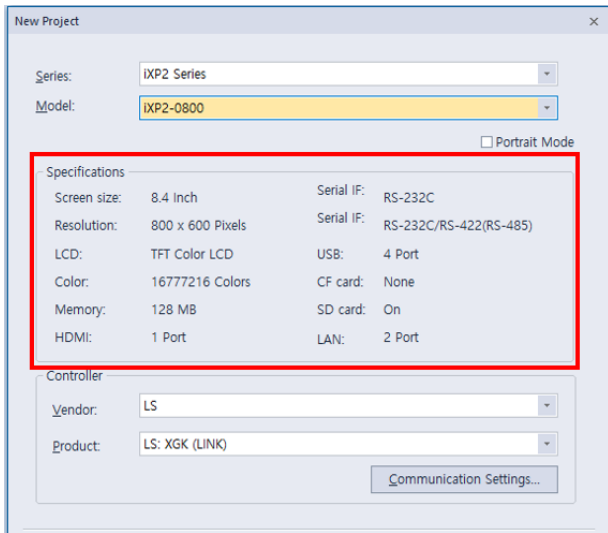

- If the computer or panel you are working with does not have the desired font installed, text information, such as captions for objects or figures may not be displayed properly. To solve this problem, install or export fonts as needed: click [TOOL] ► [Install Font] or [Export Font], specify a file location, and click [OK].

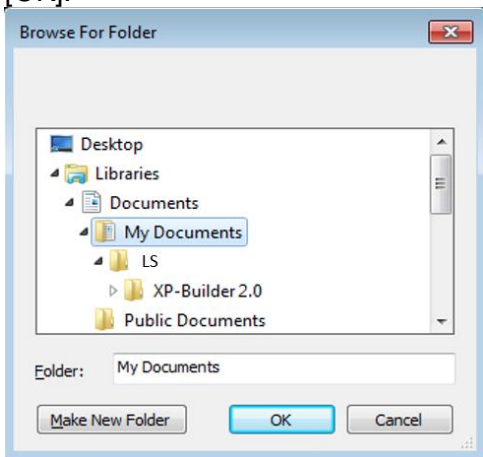

- Project files in XP-Builder are saved with the extension “.xpd.” You can only import these types of project files to XP-Builder.
- The file extension for the user object library is “.xpo.”
- The file extension for the user graphic library is “.xpg.”
- The extensions for exported files (backup files) are shown in the following table:

Item	File Extension
Text table, Recipe, and Tag	*.CSV
History alarm	*.HAL
Flow alarm	*.FAL
Logging	*.LOG
Schedule	*.SCH
Script	*.SPT

- The internal device setting area is different depending on the XGT Panel series. The settable internal device area for each series is as follows.

Series	HX	HW	HS	HK
iXP	0 ~ 63F	0 ~ 65535	0 ~ 4095	0 ~ 8191
iXP2	0 ~ 63F	0 ~ 65535	0 ~ 4095	0 ~ 8191
eXP	0 ~ 63F	0 ~ 65535	0 ~ 4095	0 ~ 4095
eXP2	0 ~ 63F	0 ~ 65535	0 ~ 4095	0 ~ 4095

2.1.2 Saving a Project

To save a project:

1 Click [PROJECT] ► [Save Project].

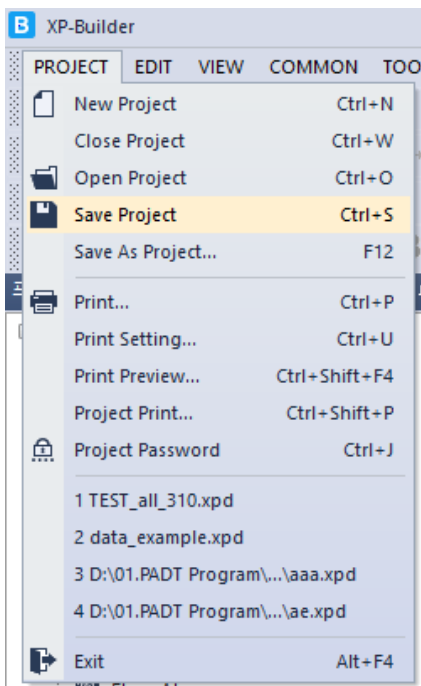

- You can also select the save project icon  from the toolbar.
- To save the file with another name, select [PROJECT] ► [Save As Project]

2 Select a destination for the saved file, enter a file name, and then click [Save].

3 To close the project, click [PROJECT] ► [Close Project].

Note

- When you save a project, two other files are created:
 - Backup file: The extensions for the backup files are “.bak” and “.bak1–bak9.”
 - OSTs file: The extension for the OSTs file is “.OSTS.” This file includes information about your project workspace, such as the current screen, docked windows, and toolbar information.
- When your project contains unsaved changes, the Project pane shows an asterisk (*) next to the project name.

2.2 Configuring Project Properties

Set the properties or parameters of the project file. Specify properties for connecting with XGT Panels, screen settings, security levels, languages, and more.

2.2.1 Protecting the Project with a Password

You can prevent others from opening a project by setting a password.

To set a password:

- 1 Click [PROJECT] ► [Project Password].

The screenshot shows a 'Password Setting' dialog box with a close button (X) in the top right corner. It is divided into two sections: 'Old Password' and 'New Password'. The 'Old Password' section contains a 'Password:' label, an empty text input field, and a 'Delete' button. The 'New Password' section contains a 'Password:' label, an empty text input field with a blue border, and a '(Max 12 Chars)' label. Below this is a 'Confirm:' label, an empty text input field, and an 'Apply' button.

- 2 Enter a password and re-enter it to confirm.

The screenshot shows the same 'Password Setting' dialog box. In the 'New Password' section, the 'Password:' field now contains four asterisks (****) and the 'Confirm:' field also contains four asterisks (****). The 'Apply' button is highlighted in yellow.

- 3 Click [Apply].

Note

- XP-Builder supports only Latin characters in passwords. Passwords are case sensitive and can be up to 12 characters long.
- Be careful not to forget the password. If you forget the password, you cannot open the project file.

To change a password:

- 1 Click [PROJECT] ► [Project Password].
- 2 Enter the current password in the **Old Password** field.

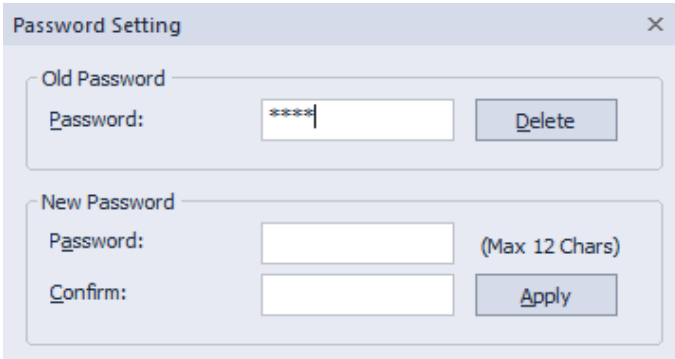

The screenshot shows a 'Password Setting' dialog box with a close button (X) in the top right corner. It is divided into two sections: 'Old Password' and 'New Password'. The 'Old Password' section has a 'Password:' label, a text input field containing four asterisks (****), and a 'Delete' button. The 'New Password' section has a 'Password:' label, a text input field, a '(Max 12 Chars)' label, a 'Confirm:' label, another text input field, and an 'Apply' button.

- 3 Enter a new password in the **New Password** field and re-enter it to confirm.

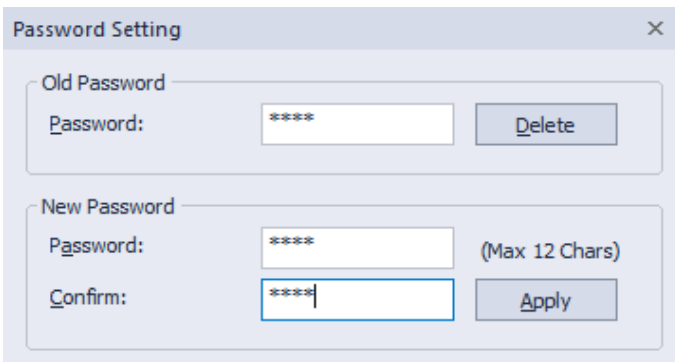

This screenshot is identical to the previous one, but now the 'New Password' section's 'Password:' and 'Confirm:' input fields are also filled with four asterisks (****). The 'Apply' button is now highlighted with a blue border.

- 4 Click [Apply].

To delete a password:

- 1 Click [PROJECT] ► [Project Password].
- 2 Enter the current password in the **Old Password** field.

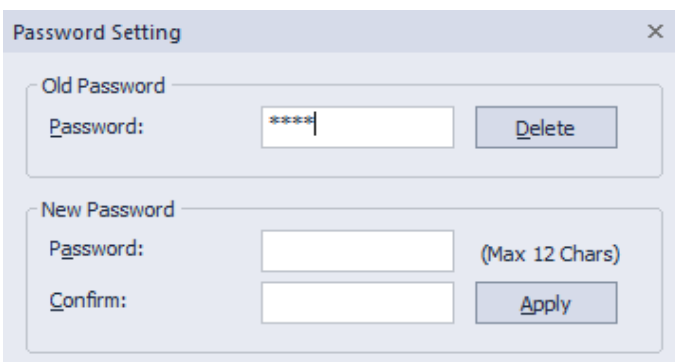

This screenshot is identical to the first screenshot, showing the 'Old Password' field filled with asterisks and the 'Delete' button.

- 3 Click [Delete].

2.2.2 Viewing and Editing Properties

XP-Builder allows you to view and edit general properties of projects. To view or edit project properties, click [COMMON] ► [Project Property Setting]. From the Project Property window, you can view or edit the following properties:

Tab	Description
Project Summary	Basic information of the project file, such as the project name and author
XGT Panel Settings	XGT Panel information and communication methods
Screen Settings	Screen change options
Security Settings	Permissions for connected XGT Panels
Key Window Settings	Settings for key windows
Language	Options for editing language and runtime language
Storage Settings	Destination and backup locations of project components and XGT Panel data
Global Script Settings	Options to apply to global scripts
Extended Device Settings	Settings for printers and barcode readers
Operation Log	Settings for saving logs of user operations
wXP Settings	Settings for the IPC series panels.
Time Synchronization	Settings for the time synchronization of XGT Panel
Device Synchronization	Settings for the device synchronization of XGT Panel internal device and PLC device.
Auxiliary Settings	Options for printing, capturing screens, displaying flow alarms, sending email alerts, displaying system alarms, and displaying communication errors

2.2.2.1 Changing Basic Project Properties

The Project Summary tab in the Project Property window contains basic information, such as the project name, file path, author, creation date, modification date, last download date, version, and project description. To change basic project properties, edit the information in the appropriate field and click [OK].

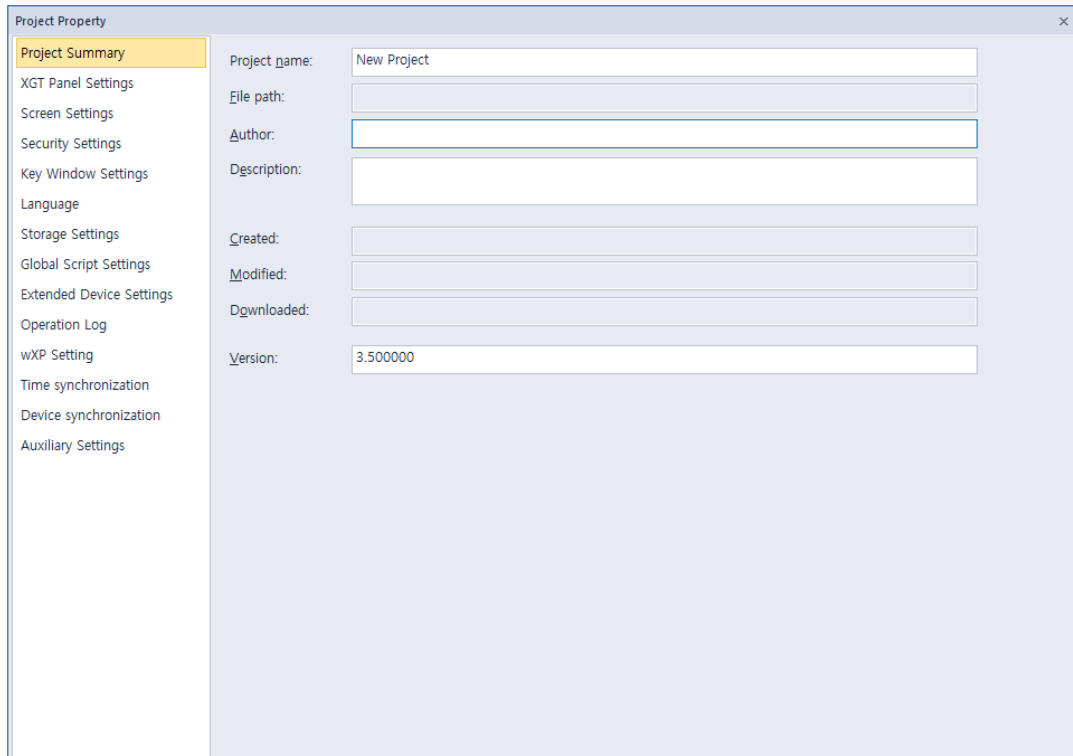

Item	Description
Project Name	The project name does not have to match the file name. The file name you specify will appear at the top of the project or screen tree in the Project/Screen pane.
File Path	The location of the project file (this cannot be edited)
Author	The creator of the file
Description	A description of the project
Created	The date the file was first created (this cannot be edited)
Modified	The date the file was last modified (this cannot be edited)
Downloaded	The date the project was last downloaded to an XGT Panel (this cannot be edited)
Version	The version of the XP-Builder software (you can change this information to create a unique identifier for customized properties)

2.2.2.2 Changing XGT Panel Settings

Edit the XGT Panel and model type. You can also set the connection method settings for connecting to controllers. The options vary by the connection method. To change XGT Panel settings, edit the information in the appropriate field and click [OK]:

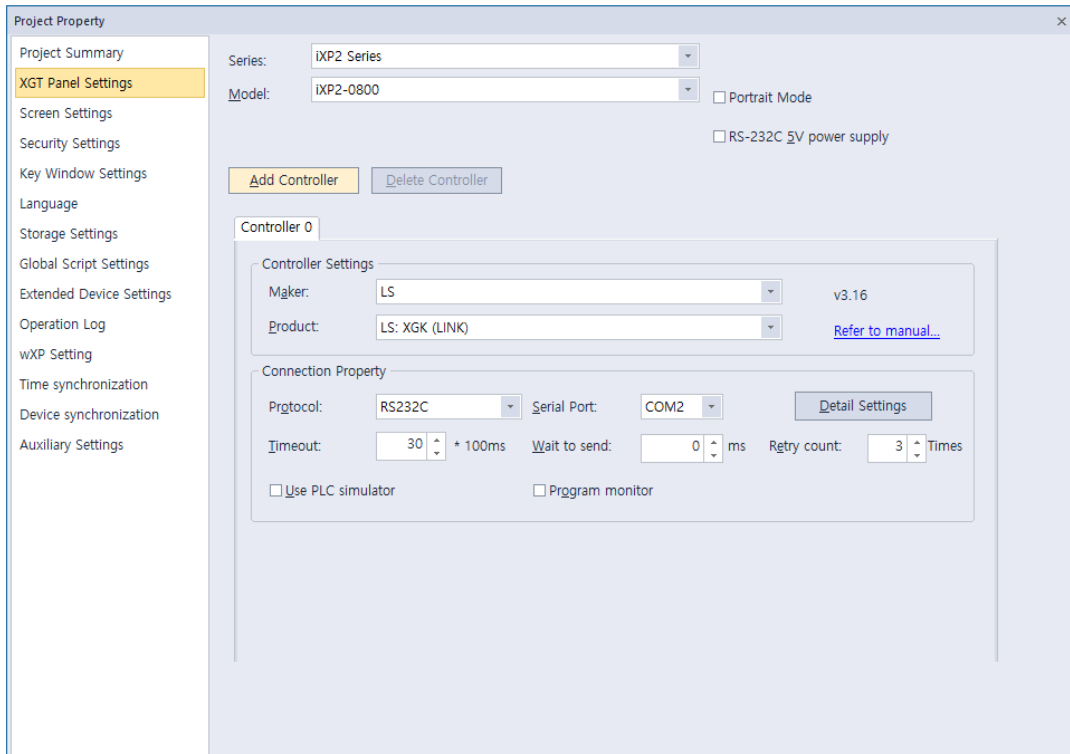

XGT Panel Settings	Description
Series	Select an XGT Panel type. The initial information is the same as you selected when you created the project. Refer to the hardware manual for detailed specifications.
Model 24 BIT Color Mode	Select a model number based on the XGT Panel type you selected. This mode is supported only by the iXP series. Select this option to use 24-bit color instead of the default setting (65,536 colors). The use of 24-bit mode improves the appearance of images on the screen, but may result in slower screen refresh speeds.
Portrait Mode (Available in iXP Series and eXP20, eXP2 Series, iXP2 Series Panels only)	Select this option to use the XGT Panel in portrait. If you have already created the XGT Panel in landscape and select the Portrait mode, the figures and objects may be resized or positioned outside of the screen. The user downloads the project to the HMI and when it is different between current state and before state (Landscape mode/portrait mode), your device will reboot. The setting is applied immediately. Refer to the hardware manual for installation precautions.
RS-232C 5V Power Supply	This mode is supported only by the iXP series. Select this option to use the RS232C connection (5 V, 250 mA) as the power supply.

XGT Panel Settings	Description
Add Controller & Delete Controller	<p>You can connect controllers with multiple protocols, including RS232C, RS422/485, or Ethernet.</p> <ul style="list-style-type: none"> • Click [Add Controller] to insert a new controller tab. The connection number for the new controller will automatically be one higher than the previous controller's connection number. XP series panels support up to four connection numbers (0-3) and the eXP/iXP/iXP2/IPC series support up to 16 connection numbers, depending on the connection protocol you use. For more information, refer to <2.9.1 Using 1:N Communication with Multiple Protocols> • Click a controller tab and then click [Delete Controller] to delete it. This option is active only after you have added at least one controller. • Connection numbers are automatically renumbered when a controller is deleted. For example, if you have three controllers (numbered 0-2) and you delete controller 1, the last controller will be renumbered from 2 to 1 automatically. • The IPC series does not support serial controllers or serial drivers.
Controller Settings	Set the controller manufacturer and controller type (Product).
Refer to Manual	Click to open the reference manual for the selected controller.
Protocol	Set the connection method between the XGT Panel and the controller. Ensure that the setting matches the actual connection between the XGT Panel and the controller.
Serial Port	This option can be selected for serial communication connections. Port selection is not required if the model has only one available port. If there are multiple ports, check the port name on the XGT Panel port and set the port number.
Detail Settings	Click to set detailed connection parameters. If a controller is selected, the default properties will be set automatically. The options available vary by the connection type.
Timeout	Set a network timeout.
Wait to Send	Set the length of time to wait for network communication between the XGT Panel and the controller.
Retry Count	Set the number of times to retry when communication fails between the XGT Panel and the controller.
Use PLC Simulator	Set whether or not to use the simulator. To run the simulator, click [TOOL] ► [Simulation]. For more information, refer to <2.6.1 Simulating an Interface> .
Program Monitor	Set whether or not to view controller data with the Program Monitor. This feature is supported by all XGK series PLCs and some XGB series PLCs only. For more information about using the Program Monitor, refer to the <i><Program Monitor></i> section of the Appendix.

XGT Panel Settings	Description
	This feature is not supported by the IPC series.

Note

- You can change the XGT Panel type to another type which supports the mode selected in the XGT Property.
- When changing the XGT Panel type, the height and width of objects on the screen may vary depending on the screen size. Objects with fixed sizes and fonts are not affected by changes of the panel type.
- If you transfer projects composed in 65,535 colors to XGT panels that support only 256 colors, the color of objects and figures may slightly vary. Color palettes are automatically adjusted and the objects and figures are displayed using the nearest colors to the original.
- Projects developed for color XGT Panels cannot be used in monochrome XGT Panels, and vice versa.

2.2.2.3 Changing Screen Settings

You can specify the startup screen that appears when an XGT Panel is turned on and the conditions for changing the screens. To change screen settings, edit the information in the appropriate field and click [OK]:

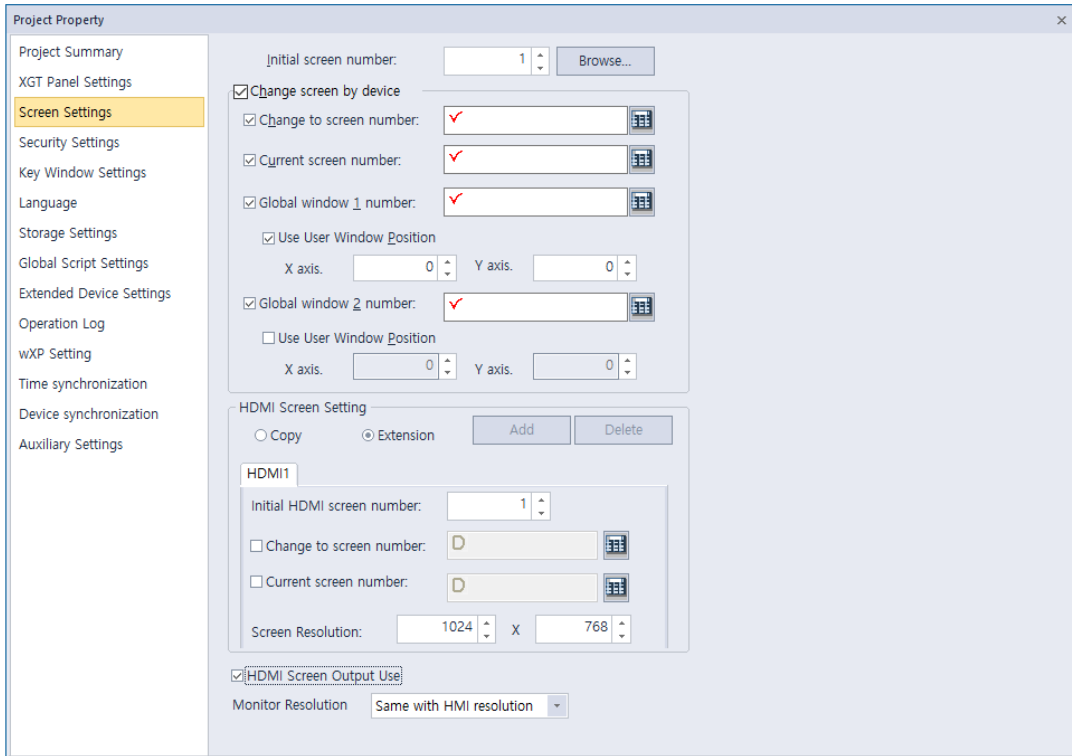

Screen Settings	Description
Initial Screen Number	Set the number of the screen that appears when the XGT Panel is turned on. If no screen is specified, an error will occur. To specify the start screen, click [Browse] ► select a screen, and then click ► [OK].
Change Screen by Device	Set whether or not to switch base screens based on the device value.
Change to Screen Number	Set the device to switch to a specified screen. When the device value changes, the screen specified by the device value will be activated (unsigned, 16-bit).
Current Screen Number	Set a number for the current base screen.
Global Window 1 Number Global Window 2 Number	Specify one or two windows that will be activated “globally” (across the entire interface) based on the device value. Windows specified here are called based on the specified device values and have no priority over each other. - Use User Window Position: The user can directly designate the location of the global window.
HDMI Setting	When connecting the HMI with HDMI on multiple monitors, HDMI screens can be monitored with Cloning and Expanding through

Screen Settings	Description
Clone	<p>the HMI. When accessing Cloning and Expanding on HMI devices, please refer to Manual 5.1.4 Environment Settings</p> <p>When in Clone mode, the HMI screen can be monitored via HDMI screen.</p>
Extension	<p>When in Expand mode, connect display via HMI and HDMI to show HDMI screens setup by XP-Builder. You can set up to 1- 4 HDMI monitors depending on the model. For more information about forming HDMI screens, refer to <2.3 Developing an Interface>.</p>
Expanded Properties : Initial HDMI screen	Select a starting HDMI screen number to monitor. Numbers between 1 through 65534 can be selected.
Expanded Properties : Change to screen number	Designate a screen transition device for HDMI screen monitoring.
Expanded Properties : Current screen number	Designate the screen device to monitor with HDMI screen monitoring.
Expanded Properties : Screen Resolution	Choose screen resolution for HDMI screens.
HDMI Screen Output Use	<p>If [HDMI Screen Output Use] is disabled, connected HDMI cables will not display screens. This will be enabled by default.</p>
Monitor Resolution	<p>You can select a resolution for HMI connected display monitors. This can only be selected by devices that support this feature.</p>

Note

- HDMI Screen settings can only be selected by devices that support HDMI feature .

New Project

Series: IXP2 Series

Model: IXP2-0800

Portrait Mode

Specifications

Screen size:	8.4 Inch	Serial IF:	RS-232C
Resolution:	800 x 600 Pixels	Serial IF:	RS-232C/RS-422(RS-485)
LCD:	TFT Color LCD	USB:	4 Port
Color:	16777216 Colors	CF card:	None
Memory:	128 MB	SD card:	On
HDMI:	1 Port	LAN:	2 Port

Controller

Vendor: LS

Product: LS: XGK (LINK)

Communication Settings...

- In portrait mode, it is impossible to set the mode to HDMI extension.
- If the project is changed from Extended mode to Clone mode or the HDMI function is not supported, the HDMI screen will be deleted, so must be taken caution
- When changing the resolution, care must be taken as it affects the resolution of existing HDMI screens.

2.2.2.4 Changing Security Settings

You can change security settings for a connected XGT Panel to regulate access for different types of users. XGT Panels support ten security levels (0 or not set: no access restriction, 9: highest security level). In the Security Settings, it can be set to unset or level 1~9. In the object, you can set the security level to restrict access to individual objects. Higher-level security can unsecure lower-level security. Lower-level security cannot unsecure higher-level security.

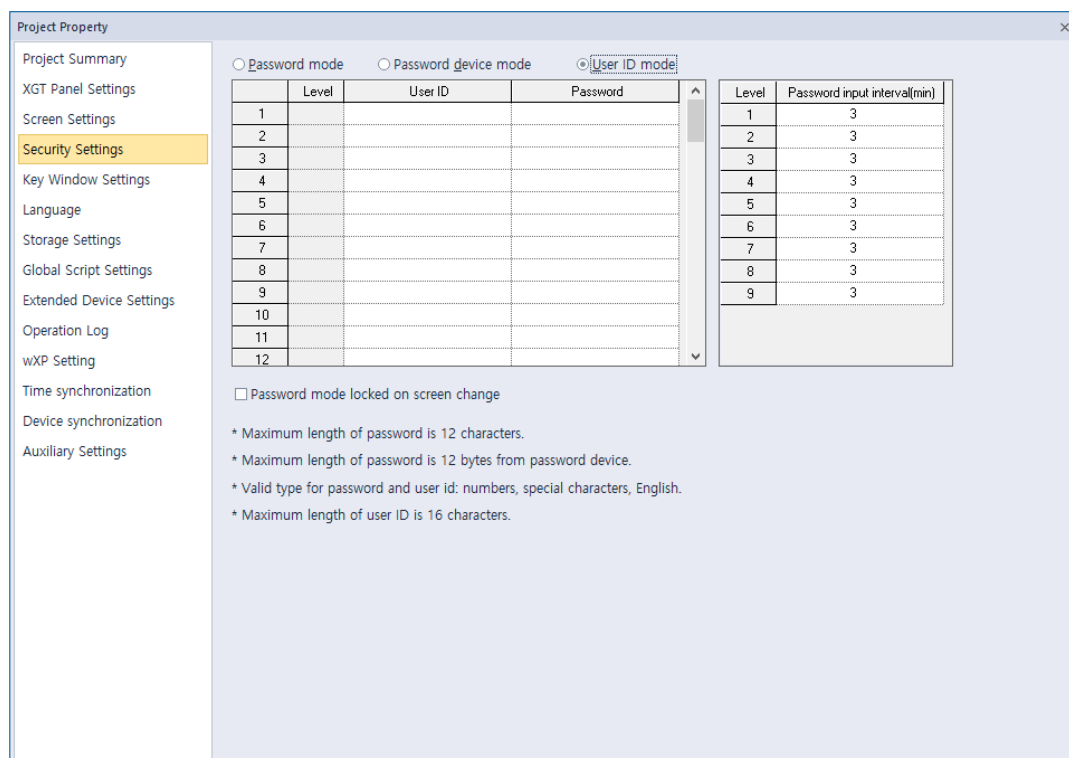

Security Settings	Description
Password Mode	Set to protect a panel with a password. Enter the passwords in the Password field for the corresponding security level.
Password Device Mode	Set to use a word device to control access to the XGT Panel. Authentication is initiated by user input, but the data contained in the first six word devices specifies the password.
User ID Mode	Set a user ID and a password to access the panel. The user ID character string can have a maximum of 16 characters. Only alphanumeric and special characters can be used for the password or user ID. A password must be entered after the user ID is entered. [User ID Mode Input Sequence] (1) Select [User ID mode]. (2) Input the ID in the [User ID] column. (3) Select a level between 1 and 9. (4) Input the password.
Security Level	Set passwords for security levels as desired. Level 0 allows access for all users, so it is not possible to specify a password (only levels 1-9 are

Security Settings	Description
	configurable). After entering a password for a certain security level, you automatically gain access to all the objects with lower security levels.
Password	Set a password. XP-Builder supports only Latin characters in passwords. Passwords are case sensitive and can be up to 12 characters long.
Password Device	Set a word device to control access to the XGT Panel. Enter a device address or click the field, and then click the keypad icon on the right side of the field to specify a device address.
Password Input Interval(min)	<ul style="list-style-type: none"> • Set the length of time to grant access after entering the password. The permission will expire based on your setting and will require the password to be re-entered. The default unit is minutes and you can set an interval from 0 to 30 minutes. • If you set the interval to “0,” a password must be entered for every operation where a security level is applied. • Use shorter intervals for highly sensitive operations.
Password mode locked on screen	When the item is checked, the password mode is locked regardless of the security level retention time even when the screen is changed, Therefore, you must disable the security by entering the password in the protected object to disable security for use. For more information, refer to the security mode locking function of the special switch.

Note

You can apply security settings to the following objects: bit switch, word switch, change screen switch, special switch, multi switch, numeric input, and text input.

2.2.2.5 Changing Key Window Settings

You can set the key window number for input devices. The key window set here is applied as the default for all key windows. To change key window settings, click the arrow buttons (▼ or ▲) to select a new window number, or click [Browse] and then click a key window type.

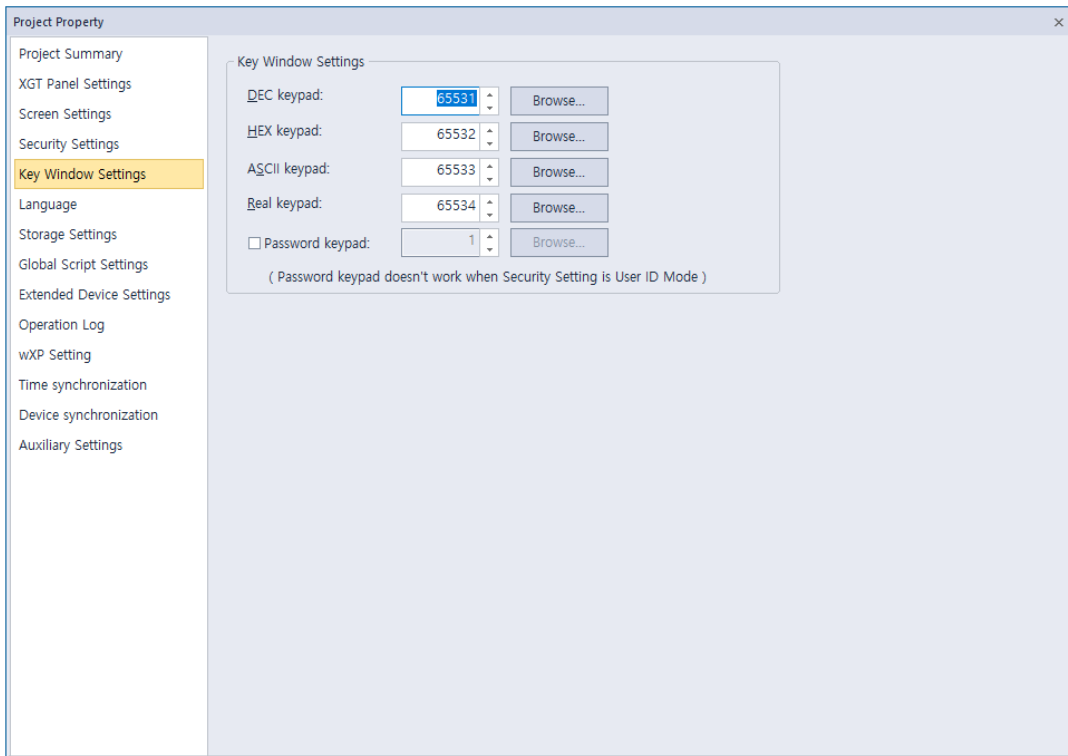

2.2.2.6 Changing Languages

The following language types are used in a project to display different information.

Language types	Description
Editing language	Editing language is the language that users can configure and use to create multilingual text tables. You can choose different fonts to add entries in different languages. The fonts for editing languages are included in the project, but are not transmitted to the XGT panel.
Runtime language	Runtime language is the language that is downloaded to the XGT panel. The runtime language fonts are transmitted to the XGT panel as TTF (true-type font) files. In the Project Property settings, you can select up to 12 different runtime languages.

From the Language tab, you can edit both editing and runtime language settings. To change language settings, edit the information in the appropriate field and click [OK]:

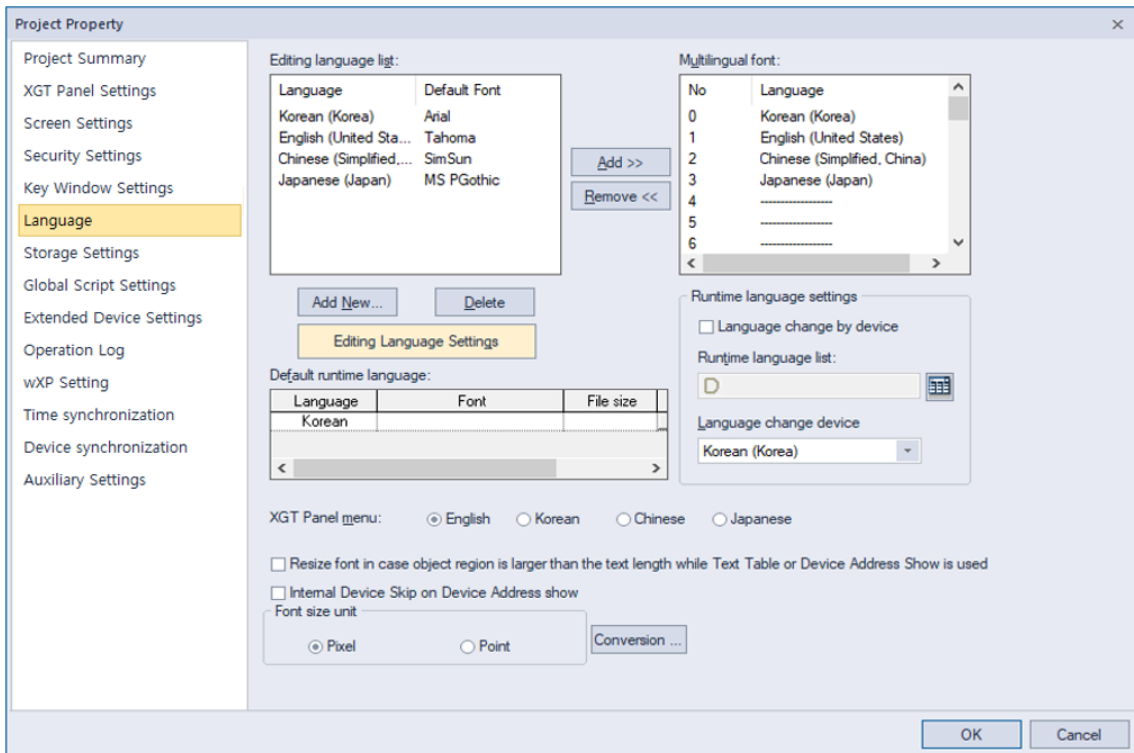

Language Settings	Description
Editing Language	<ul style="list-style-type: none"> Set the languages used in XP-builder. Languages shown in text tables are set here.
Add New	Click to add additional display languages to the interface. Select a language from the list and then click [OK] to add it to the Editing Language List.
Delete	Select a language, and then click to remove it.

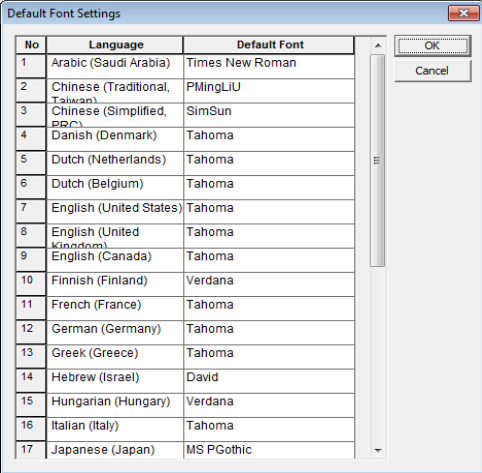
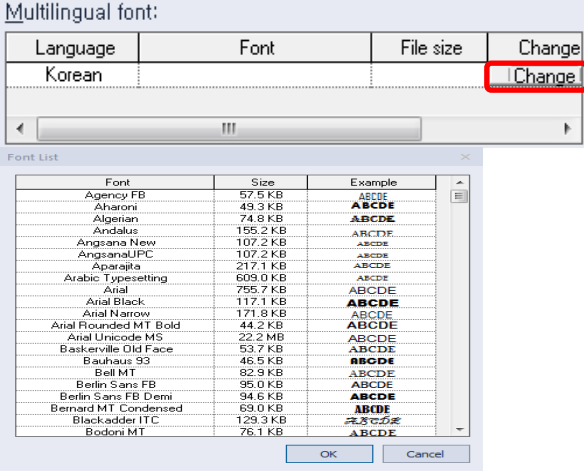
<p>Language Settings</p>	<p>Description</p>
<p>Editing Languages Settings</p>	<p>Change the default font for each editing language.</p> 
<p>Runtime Language List</p>	<p>View and specify runtime languages to use with the project. You can modify the font list by adding fonts from a list of editing fonts or deleting them.</p>
<p>Multilingual Font</p>	 <ul style="list-style-type: none"> • Set a font to transfer with the project file. This function is useful when the XGT Panel does not support Asian characters, such as in the case of XP series panels that run the Windows CE operating system. • If you select this option, the entire font will be transferred to the panel. Ensure that the size of the font file does not exceed the available memory of the XGT panel model. • Multilingual fonts are also used for table headers in text input, text display and logging backup CSV files. Refer to <4.3.4.4 Text Display>.
<p>Language Change by Device</p>	<p>Set the runtime language to change for specific devices. The XGT Panel reads the value from the device and displays the interface in the language you specify in the Runtime Language List.</p>

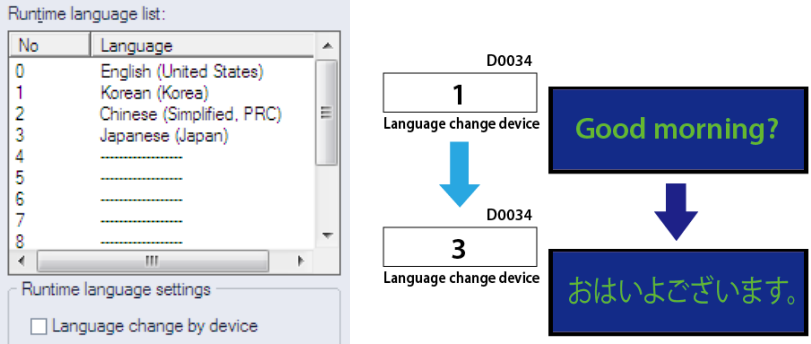
Language Settings	Description
	
Device	Select a word device (language change device).
Default Runtime Language	Set the runtime language that will be used by default on the XGT Panel.
XGT Panel	<p>The language for the XGT Panel menu screen is selected. The default language is English.</p> <p>In the IPC series, the menu screen language depends on the setup file languages.</p>
Resize Font	<p>The length of an object's character string, calculated from the character string table, will vary based on the language. If the length of the character string is larger than the width of the object, the font size of the character string is automatically reduced when displayed. The minimum font size is 9.</p>
Resize font in case object region is larger than the text length while Text Table or Device Address Show is used	<p>This feature applies to objects that use text tables, or to the device addresses of text display objects. When the language is changed, if the length of the character string is larger than the width of the object, the font size of the text or address is automatically reduced when it is displayed.</p> <p>(The minimum font size is 9.)</p>
Internal Device Skip on Device Address show	<p>This function excludes internal devices when displaying device addresses in an object. If this option is checked, the address is not displayed in the text indicator in which [Bit Device Address] or [Word Device Address] is set. Refer to <4.3.4.4 Text Display> for detailed information.</p>
Font Size Unit	<p>In general, when displaying the font size, it can be displayed in pixel units and point units. Set the font size unit to be displayed.</p> <p>In the case of MS S/W (MS Word, MS Excel, etc.), the font size is displayed in point unit. In case of XP-Builder, the unit is displayed in pixel as default.</p> <p>Even with the same font size, the font size displayed may vary depending on the display units.</p> <p>For example, the same [Sample] letter as shown in the table below is 16px for pixel units, but 12pt for point units.</p>

Language Settings
Description

Pixel <-> Point
x

Pixel: px >> Point: pt

Pixel	Point	[Tahoma Sample]
9 px	7 pt	Sample
10 px	7.5 pt	Sample
11 px	8 pt	Sample
12 px	9 pt	Sample
13 px	10 pt	Sample
14 px	10.5 pt	Sample
15 px	11 pt	Sample
16 px	12 pt	Sample
17 px	13 pt	Sample
18 px	13.5 pt	Sample
19 px	14 pt	Sample
20 px	15 pt	Sample
21 px	16 pt	Sample
22 px	16.5 pt	Sample
23 px	17 pt	Sample
24 px	18 pt	Sample

Note

- The font used in a text table is set by the default settings of the editing language. Text may not be displayed properly if the text of a text table cannot be represented by the default font.
- If you set the language to change by device, you must designate a language for the device or nothing will be shown in the XGT Panel. Refer to **<2.2.2.6 Changing Languages>** for detailed information.

2.2.2.7 Changing Storage Settings

Set the storage locations for image and font files, as well as the locations for backing up logging data recipes and screen captures from an XGT Panel.

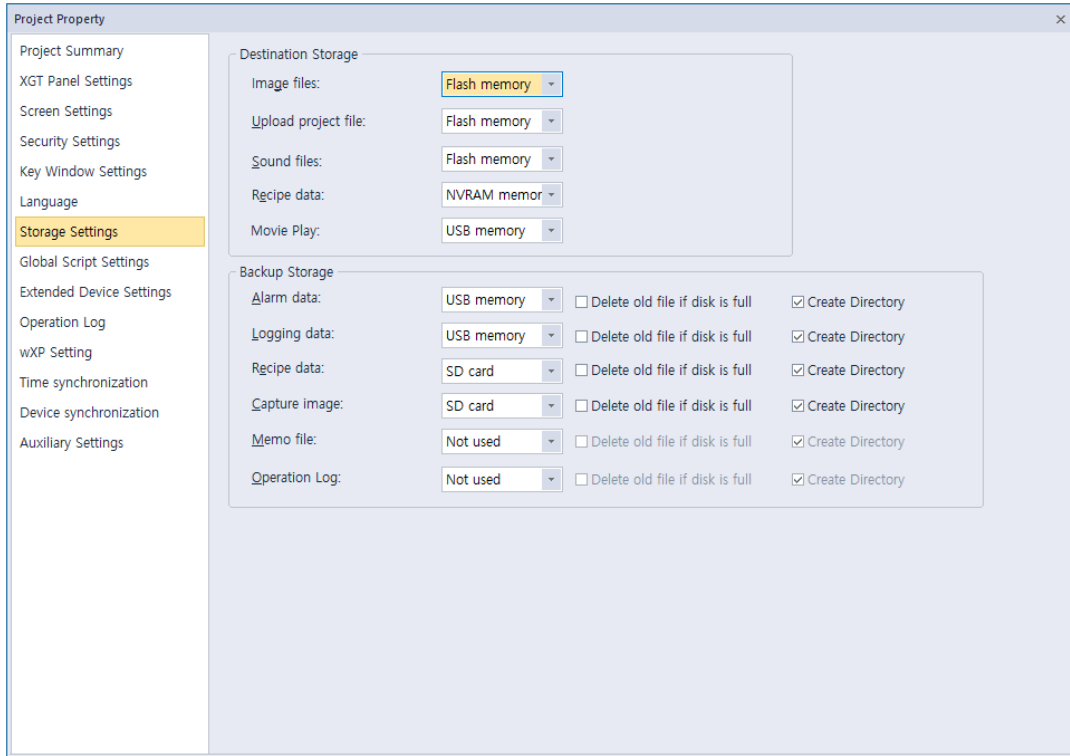

Storage Settings	Description
Image Files	XGT Panel has a fixed amount of memory for saving project files. If you want to download XGT Panel data that exceeds the size of the allocated memory, you can save files on removable media. Use the entire path to specify the storage file path on the XGT Panel. In the IPC series, only a flash memory drive or hard disk drive can be used for storing the data.
Upload Project File Sound Files Recipe Data	Specify locations where files will be stored. In the IPC series, only a flash memory drive or hard disk drive can be used for storing the data.
Alarm Data Logging Data Recipe Data Capture Image Memo File Operation Log	Specify an external location where the data will be saved.
Delete Old File If Disk is Full	Select this option to overwrite existing data if the disk is full. The oldest data will be deleted.
Create Directory	Backup data such as alarm, logging, and recipe are backed up with a unique folder name. If you uncheck "Create Directory", you can back up files to the root of the backup directory without creating a unique folder.

Storage Settings	Description
	Note that only one of the backup items such as alarm, logging, or recipe can be unchecked "Create Directory".

Note

- XGT Panels support four types of removable storage devices: USB devices, CF cards, and SD cards (only supported in the iXP/iXP2/IPC series), MicroSD (only supported in eXP2 series).
- X30-BTE, XP30-TTE, XP40-TTE, XP40-TTA, XP50-TTE, iXP, iXP2, eXP, eXP2 models do not support CF cards.

2.2.2.8 Changing Global Script Settings

Global script conditions are monitored through an XGT Panel and executed if the conditions are met. Up to 32 global scripts can be created. If two or more conditions are met simultaneously, scripts are executed based on the priority that you specify.

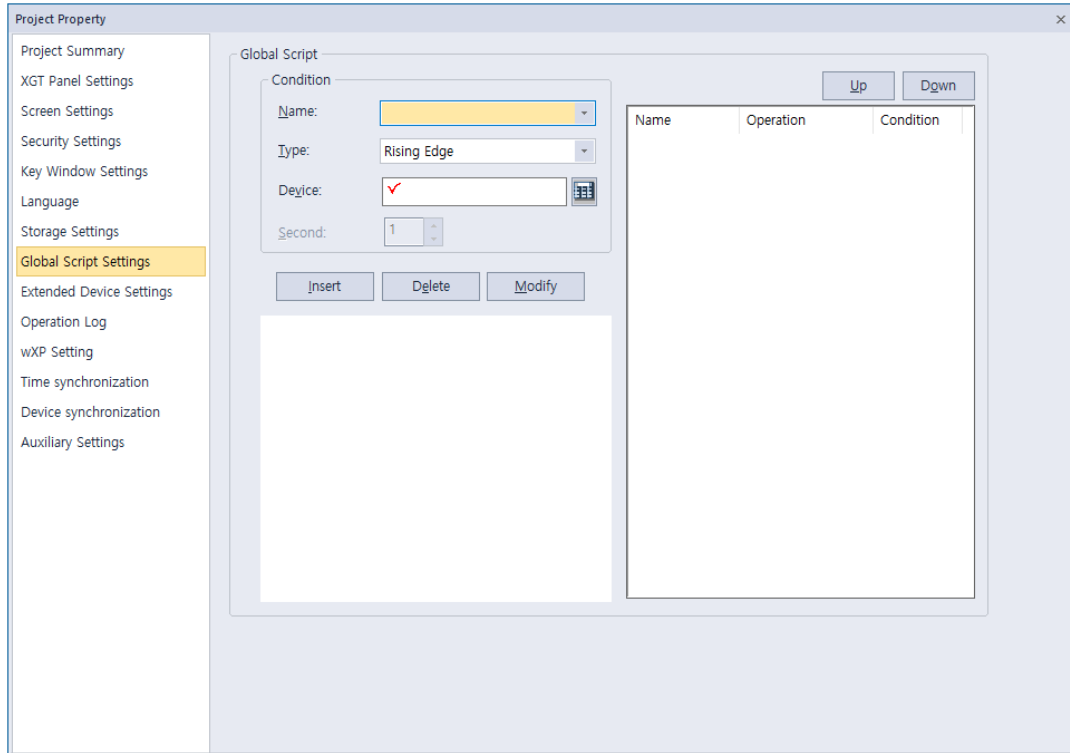

Global Script Settings	Description
Name	Set a script name.
Device	Set a bit device that meets the conditions required to execute the script.
Type	Choose a trigger type for executing the script (Rising edge or Falling Edge).
Second	Only available when scripts are repeated regularly, and will set the interval to seconds.
Insert, Delete, Modify	Click to insert, delete, or modify global scripts.
Up Down	Specify the execution priority for when two or more conditions are met simultaneously.

2.2.2.9 Changing Extended Device Settings

You can connect a barcode reader to an XGT Panel's RS-232C port (COM2) and use printer functions.

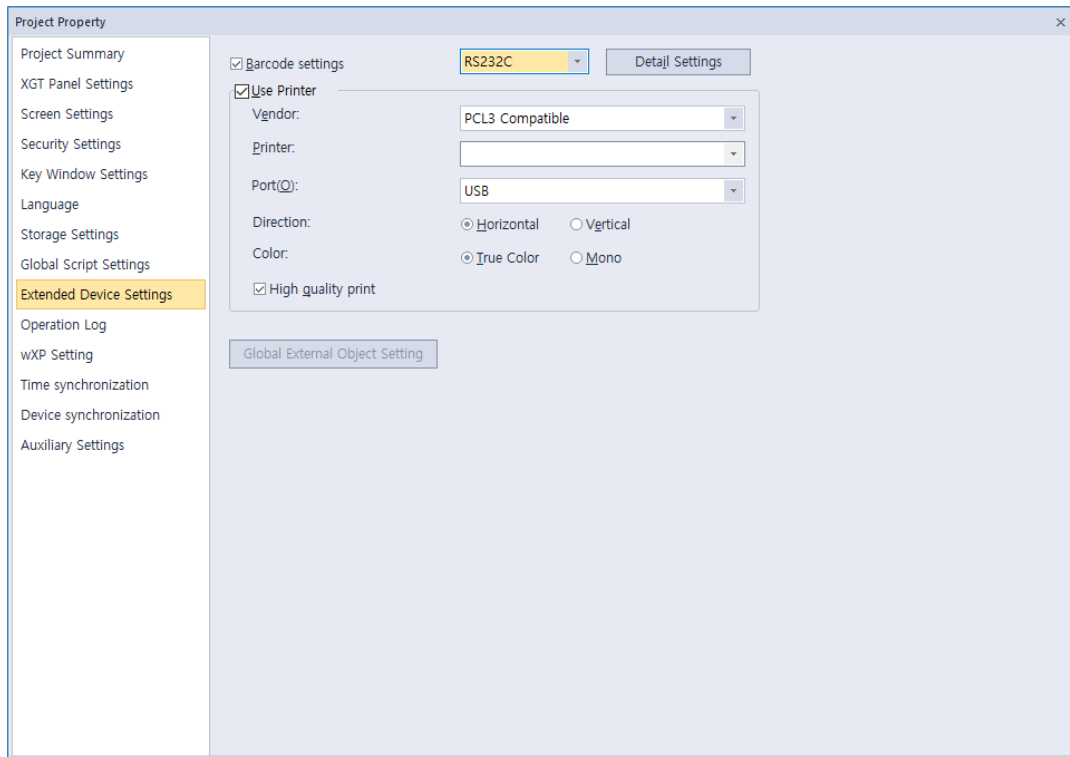

From the Project Property window, you can view or edit the following properties of a barcode reader that is connected to an XGT Panel:

Item	Description
Barcode Settings	Set to connect barcode reader to XGT Panel.
Connection Property	Set to use the barcode through the RS-232C / USB protocol.
tail Settings	<p>Set detail connection options:</p> <ul style="list-style-type: none"> • Bytes to read: Set the amount of data to read from a barcode. If you set the number of bytes, the XGT Panel reads only the specified number of bytes. If you do not specify this setting, the XGT Panel reads the entire barcode. • Save data in: Set a location for saving barcode data. Data is saved from the specified device continuously. • Data storage: Enter the first device to receive data from the barcode. • Read complete device: Assign a bit device to set when all data has been read. • Set the RS-232C communication parameter, such as the baud rate, data bits, and flow control. • COM port: Set the communication port. This setting is supported by the IPC series only.
Note	

Item	Description
	<p>The baud rate must match the setting in the XGT Panel. To change the baud rate on the XGT Panel, tap and hold the screen to access the menu. Then, tap [Setting] ► [PC Conn Setting].</p> <hr/> <p>Note</p> <ul style="list-style-type: none"> • For USB barcode, don't need to set connection options depending on the usage environment. (See how to use the USB barcode reader at the bottom) • For USB barcode, input value of USB is saved in [Data Storage] only when the connection option is set and the HS501.2 device is ON. • After the waiting time for the barcode input, the input is saved after initializing the [Data Storage] value.
Use Printer	Set to use the printer option. The IPC series does not support printing.
Vendor	Select a vendor for the printer type.
Port	Select the printer port.
Direction	Set the directions.
Color	Set the color type.
High Quality Print	Set the properties for printing quality.
External Object Setting	<p>It can be set only in handy model (e.g. iXP2H). This is the setting for the globally operable HW key for the handy. For information on setting the Handy HW key that can operate on the local screen within on screen, refer to <2.3.11 Setting HW Key for Handy on screen>.</p> <p>When you press the button, the following dialog box appear. You can set external lamp or external multiple switch. For details, refer to the corresponding object or HW manual.</p>

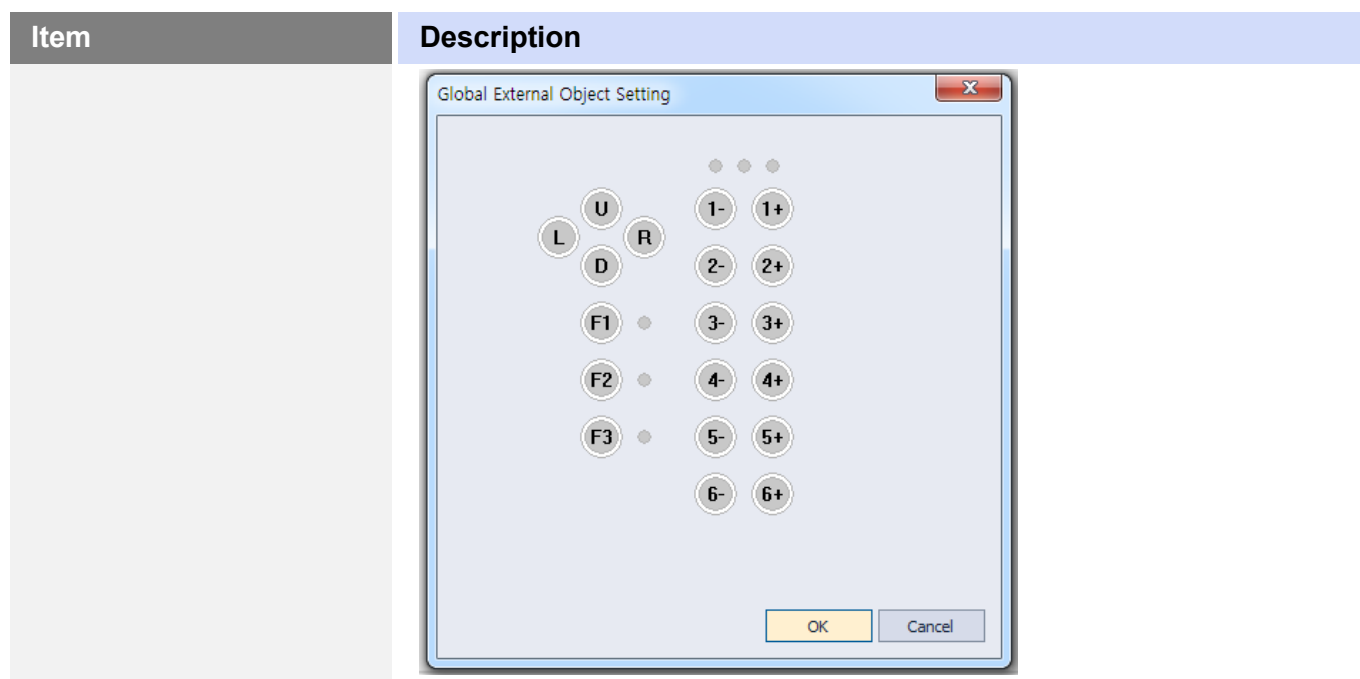

To connect a barcode reader:

- 1 Select [COMMON] ► [Project Property Setting] ► [Extended Device Settings].
- 2 Check the checkbox next to **Barcode settings**.
- 3 Click [Detail Settings] and specify the following settings:

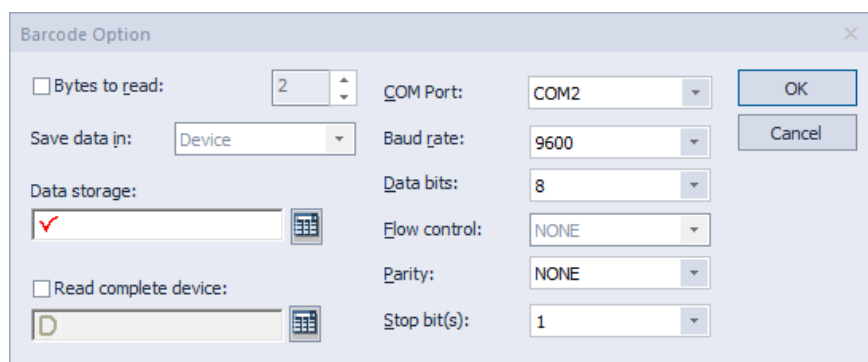

To connect a USB barcode reader:

- 4 Select [COMMON] ► [Project Property Setting] ► [Extended Device Settings].
- 5 Check the checkbox next to **Barcode settings** and select USB.
- 6 Click [Detail Settings] and specify the following settings:

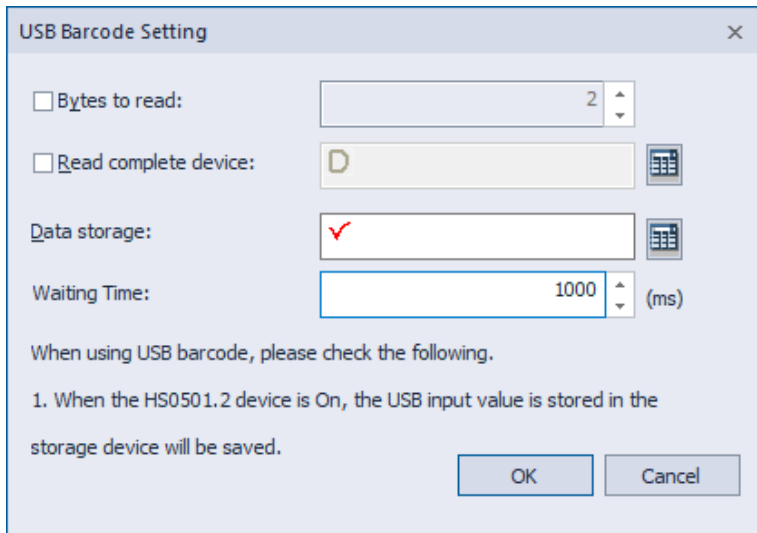

The method of USB barcode reader:

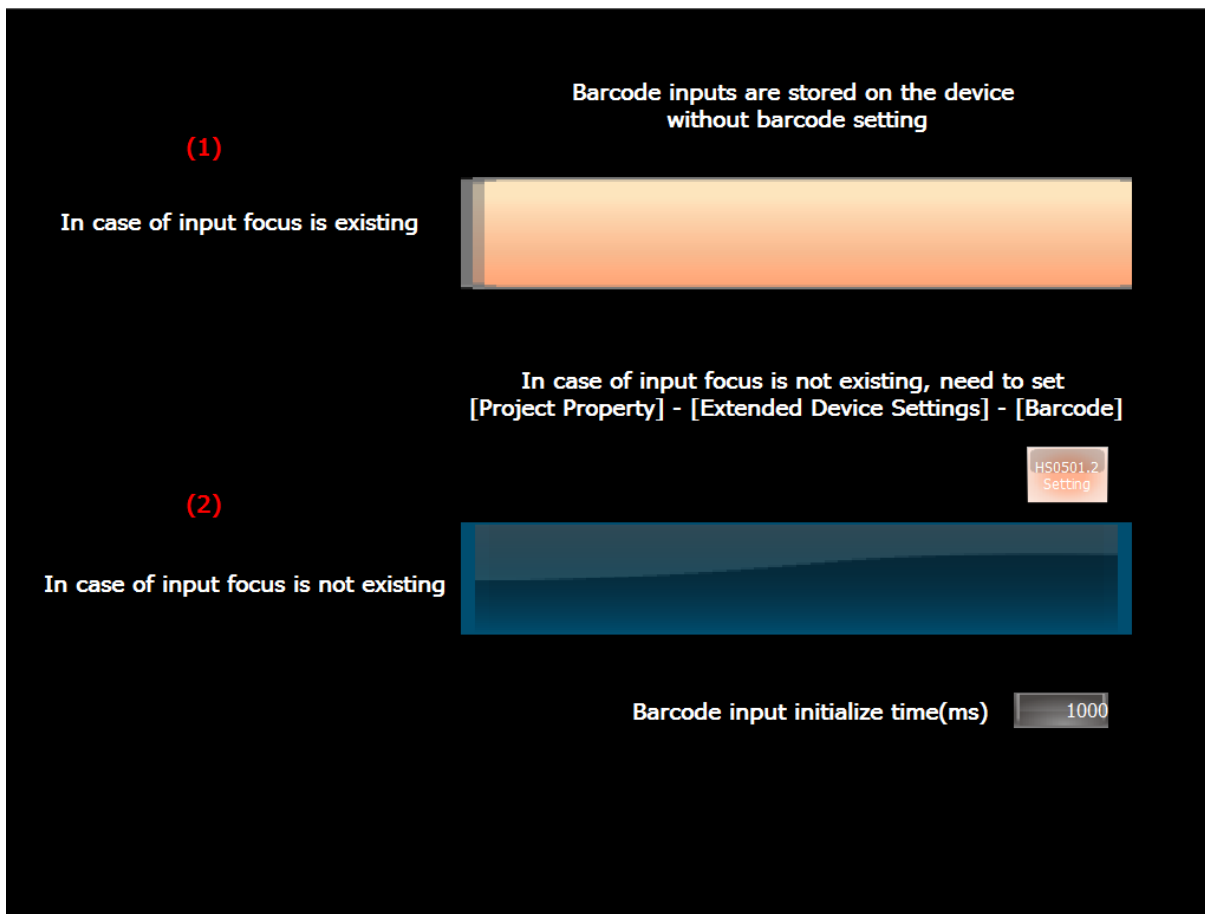

- 1 In case of the text input or numeric input is in the input state as in the above screen (1)
 - Even without [Detail Settings] setting, the information of the entered barcode is saved in the device of the corresponding input device.

- If [Detail Settings] is set and the internal device HS0501.2 is ON, it is simultaneously saved to the device set in [Data Storage].

2 In case of the text input or numeric input is not in the input state as in the above screen (2)

- In this case, set as USB after checking [Barcode Settings] on [Project Property] – [Extended Device Settings]
- Set [Data Storage] in the [Detail Settings]
- In case of the internal device HS0501.2 is ON: The entered barcode value is saved in [Data Storage]. For example, in the above screen, press the switch of HS0501.2 to turn it On, and then enter the input barcode value.
- In case of the internal device HS0501.2 is OFF: Input is not possible. To receive input data while maintaining the OFF state, make an input state as (1) and scan it.

3 Utilization of waiting time for barcode input

- Input within the barcode waiting time (unit ms) is continuously stored in [Data Storage].
- Since [Barcode input initialize time] is 1000ms on the above screen, all inputs within 1000ms interval are entered in [Data Storage].
- If barcodes are scanned continuously within 1000ms, they are recognized as one barcode and all are saved. If the interval between consecutive scans is 1000ms or more, it is entered after initializing the [Data Storage].
- The time can be adjusted with the internal device (HS0507) in addition to [Detail Settings].

2.2.2.10 Changing Operation Log Settings

You can use the Operation Log function to record the operations on the XGT panel. This function enables you to check which operation was performed, and when or where it was performed. With this function, you can analyze the causes of errors or other problems from the recorded log.

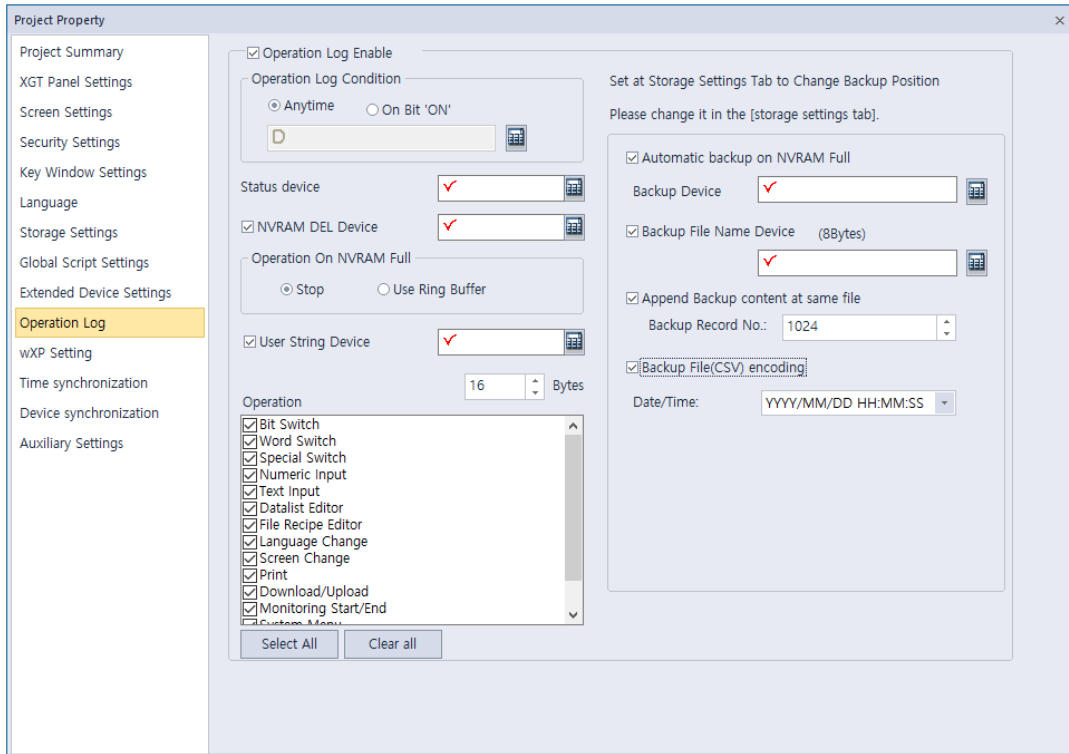

Item	Description
Operation Log Enable	Set whether or not to use the Operation Log function.
Operation Log Condition	Set when to record logs. <ul style="list-style-type: none"> • Continuous: Logs are recorded continuously. • On Bit 'ON': Logs are recorded when a bit device is set to ON.
Status Device	Set a word device to control log recording.
NVRAM DEL Device	Set a device to delete the operation log area of the NVRAM.
Operation On NVRAM Full	Set the action that occurs when the NVRAM is full. <ul style="list-style-type: none"> • Stop: Logs will not be recorded if the NVRAM is full. • Use Ring Buffer: If the NVRAM is full, the oldest record will be deleted and logs will be recorded accordingly.
User String Device	Set a word device to control user strings. A maximum of 16 bytes can be recorded.
Operation Log List	Select which operations will be recorded.
Backup Device	Set a device to store the operation log.
Automatic Backup on	Set whether or not to execute backup automatically when the NVRAM

Item	Description
NVRAM Full	is full.
Backup File Name Device	Set a device to store the names of backup files. A maximum of 8 bytes can be stored.
Append Backup Content at Same File	Set whether or not to append another backup set to the existing backup file. If this option is checked, the previous contents of the backup file remain intact, and the new backup will be written after the end of the last backup. A maximum of 1024 backup records can be stored in a single file. If this option is not checked, the new backup will be saved as a new file.
Backup File (CSV) Encoding	Set whether or not to encode a backup file (CSV or Encrypted CSV file).
Date/Time	Set the date or time format to use for a backup file.

Note

- The Operation Log function is available on iXP/iXP2/IPC series panels only. (XP is only available in V2.20)
- The following diagram briefly explains how an operation log is recorded.

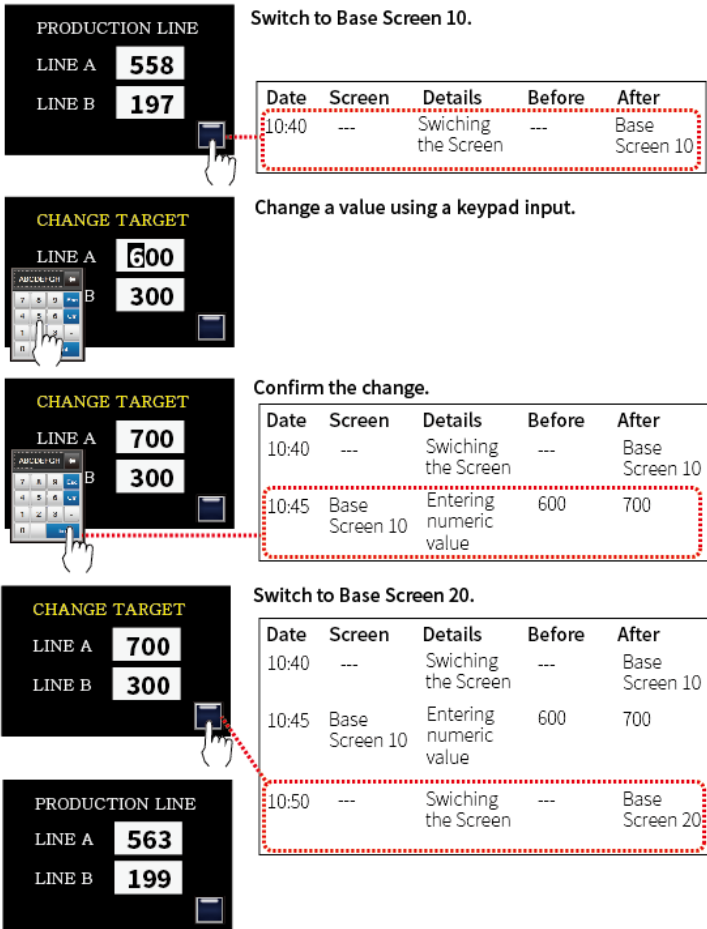

- Describes the value information for the state device.

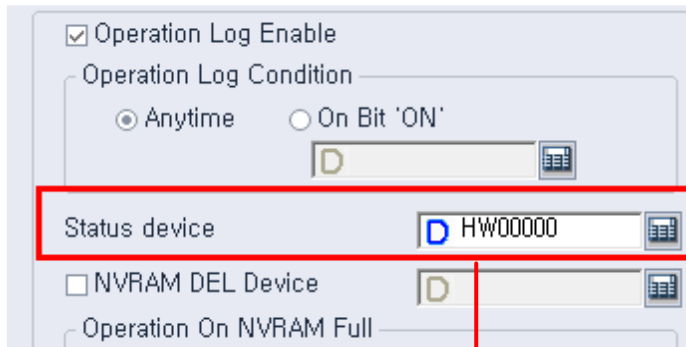

16bit Lower Byte

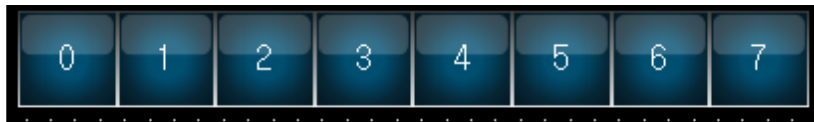

	Off(0)	On(1)
Bit 0	End of Progress	Proceeding
Bit 1	Backup device is inserted	backup device is not inserted
Bit 2	Log SRAM area write failed	Log SRAM area write successful
Bit 3	There is free space in the log SRAM area.	The log SRAM area is full
Bit 4	Clear log SRAM area	Completion of clear of log SRAM area
Bit 5	Failed to write log backup	Log backup successful
Bit 6	There is free space in the write log area.	The log write area is full.
Bit 7	Clear a log backup	Log Backup Delete Complete

- Maximum per device.

	Maximum number of backups
XP General	490
iXP/iXP2/IPC	983

2.2.2.11 wXP Settings

Set the wXP drive path for the CF/USB/SD memory you selected in the storage settings. This feature is supported by the IPC series only.

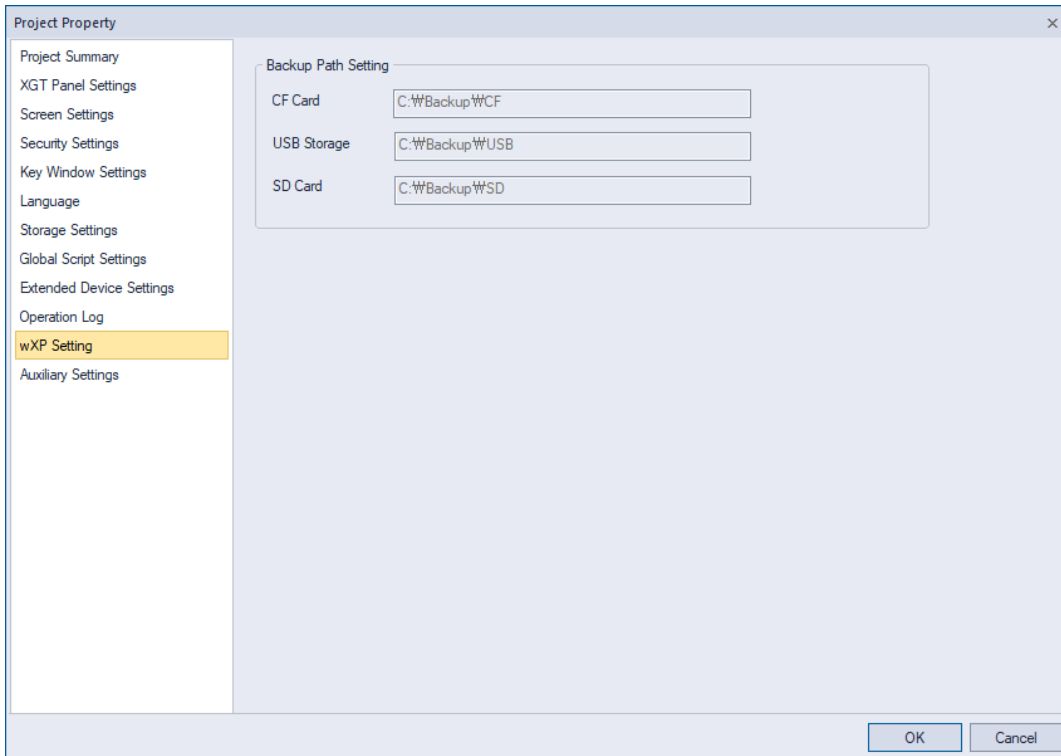

Item	Description
Backup Path Setting: CF Card	Set the wXP hard disk drive path to store backup files when you have selected 'CF Card' as the storage device.
Backup Path Setting: USB Storage	Set the wXP hard disk drive path to store backup files when you have selected 'USB Storage' as the storage device.
Backup Path Setting: SD Card	Set the wXP hard disk drive path to store backup files when you have selected 'SD Card' as the storage device.

2.2.2.12 Time Synchronization Settings

You can set the function to synchronize the HMI time to the PLC time.

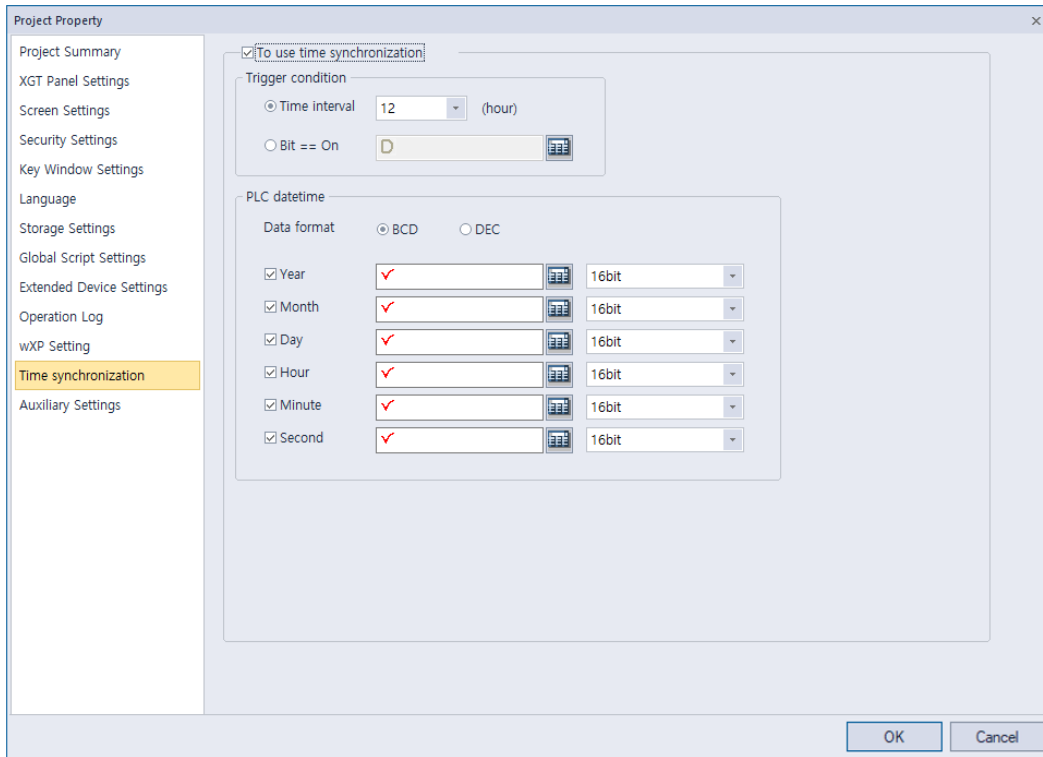

Item	Description
Trigger condition	- Time Interval: Synchronize HMI time with PLC time according to the set (time) interval. - Device: When the set device is turned on, the HMI time is synchronized with the PLC time.
PLC datetime	To change a specific value among year/month/day/hour/minute/second.

Note

- If [Time synchronization] is set, synchronization with PLC time is performed unconditionally once when monitoring XGT Panel starts.
- Synchronization is not performed for less than 5 seconds after the first synchronization from the start of monitoring.
- When monitoring is restarted, the elapsed time is recalculated.
- In consideration that the value of “Year” in PLC is usually 1 byte of BCD, it is converted and operated as follows.

Year Input Value (value read)	Year Setting Value
00 - 99	2000 - 2099
Other range	Corresponding Value

2.2.2.13 Device Synchronization Settings

You can set the function to synchronize the device values of HMI and PLC periodically.

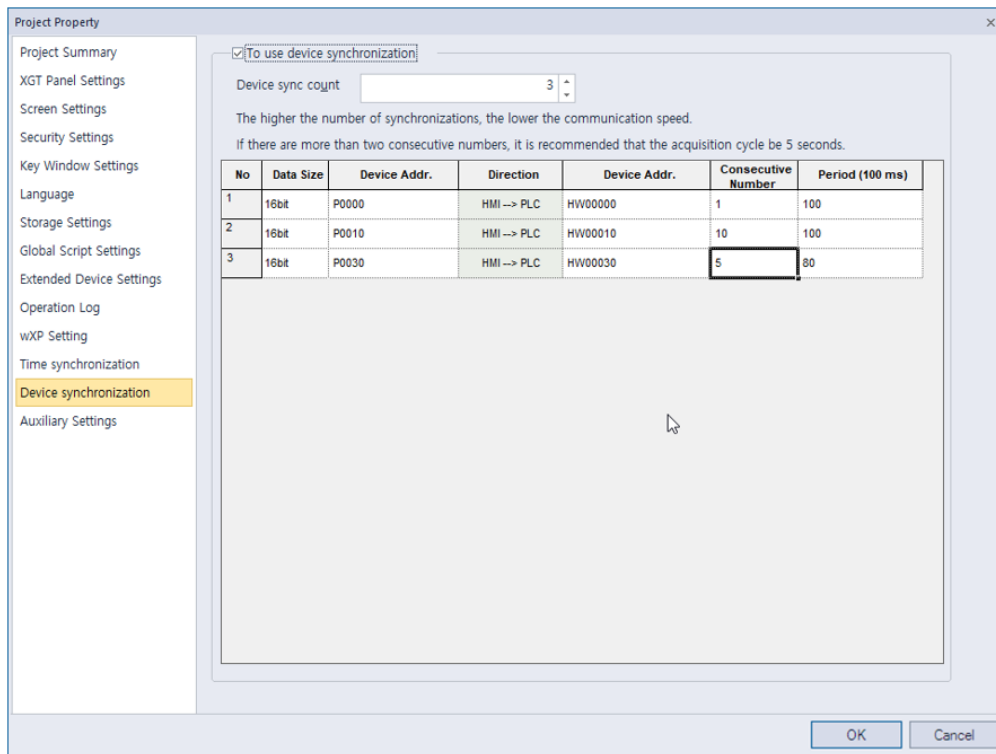

Item	Description
Data Size	Set the device data size. - 16bit upper byte - 16bit lower byte - 16bit - 32bit
Device Address	Set the target device address (source) to synchronize.
Direction	Set the sync direction. Synchronization is performed from the left device (source) to the right device (target).
Device Address	Set the target device address (target) to be synchronized.
Consecutive Number	Synchronization is performed as many as consecutive numbers starting with the target device address to be synchronized. You can set from a minimum of 1 to a maximum of 100. If there are more than 2 consecutive number, it is recommended that the period be 5 seconds or more.
Period	Set the synchronization cycle. The unit is *100ms, with a minimum of 10 and a maximum of 150. That is, it can be set from 1 second to 15 seconds.

Note

- The higher the number of synchronizations, the lower the communication speed.
 - The more settings there are more than 2 consecutive numbers, the slower the speed will be. Therefore, if the consecutive number is large, set the synchronization period to be greater than 5 seconds.
 - If the write device is a PLC device among the read device that reads the device value and the write device that writes the value, the speed is reduced. For this purpose, write operation is performed only when the value of the read device is changed.
 - You can set up to 128 entries.
-

2.2.2.14 Changing Auxiliary Settings

You can set the screen capture action and properties of the system alarm display.

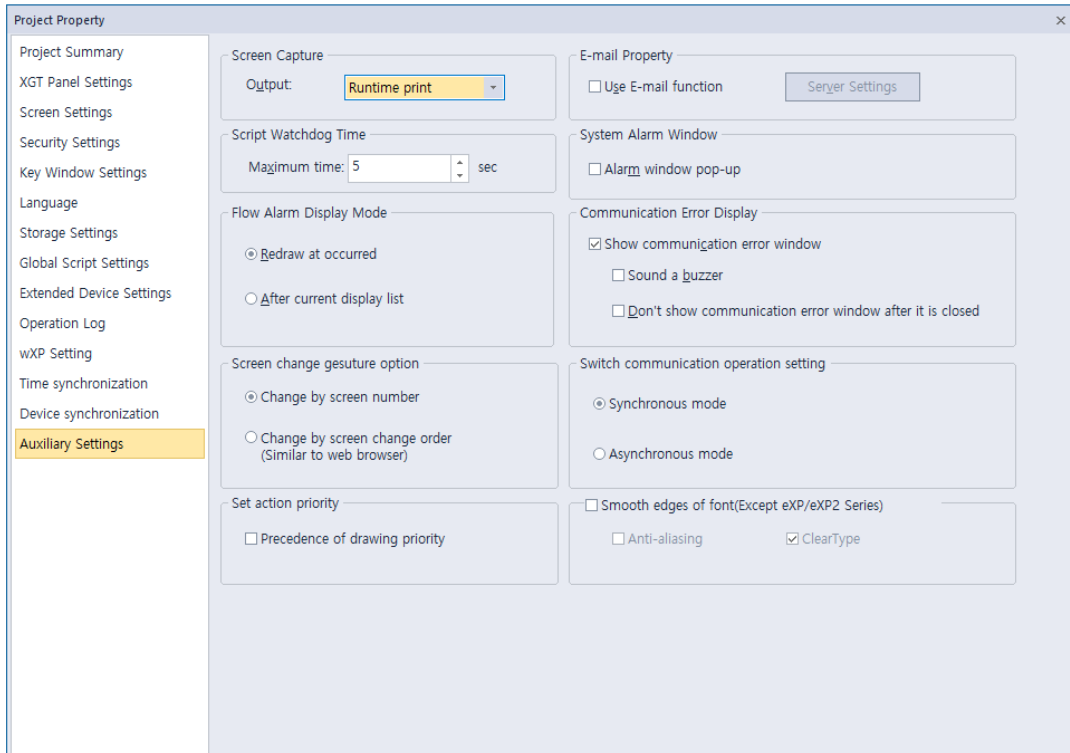

Auxiliary Settings	Description
Screen Capture	Set the action that occurs when the screen is captured on the XGT Panel. You can save the image in a file or print it. The IPC series does not support screenshot printing.
Script Watchdog Time	Set the Watchdog time for a script. A script will end if it is not run within the maximum time set.
Flow Alarm Display Mode	<ul style="list-style-type: none"> Set to display the alarm message for the states of the flow alarm. When a flow alarm occurs and is then reset while the alarm message is displayed, you can specify one of two actions to occur: <ul style="list-style-type: none"> Redraw at occurrence: The alarm message is replaced automatically with a new message. After current display list: The alarm message remains on the screen and new alarms or cleared alarms will be shown by subsequent messages.
E-mail Property	Set whether or not to use email alerts.
Server Settings	Set email settings. For more information, refer to the note below.
System Alarm Window	Set whether or not to display system alarm messages.
Communication Error Display	Set whether or not to display communication error messages on top of other screens. If the buzzer activation option is checked, the buzzer is

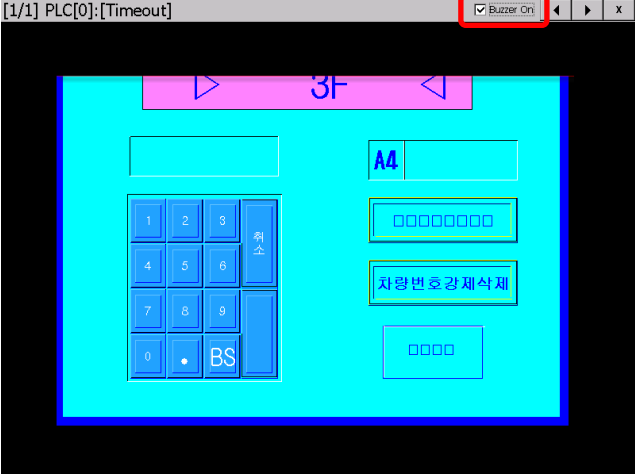
Auxiliary Settings	Description
	<p>activated when an error pop-up message is displayed. To stop or resume the buzzer's sound, check or uncheck Buzzer On at the right side of the communication error window.</p>  <p>The IPC series does not support buzzer sounds.</p>
<p>Don't show communication error after it is closed</p>	<p>Select this option to stop viewing error messages after you close the first communication error notification.</p>
<p>Screen change gesture option (Available from version 2.11)</p>	<p>Choose a screen transition gesture between screen number transition and the Next/Return screen transition.</p> <ul style="list-style-type: none"> - Change by screen number <ul style="list-style-type: none"> • The screen will move based on the screen number. • When going to the next screen on the last screen, it will move you to the first numbered screen. • When going to the previous screen on the first screen, it will move you to the last numbered screen. - Change by screen change order (Similar to web browser) <ul style="list-style-type: none"> • Screens will be shifted based on their screen history. (Similar to the undo/redo mechanic of web browsers.) <p>▶ For example, if you perform the return gesture on screen 20 after accessing screens 1, 10, and 20, you will return to screen 10.</p>
<p>Prioritize the operation of XP-Runtime</p>	<p>Precedence of drawing priority: When displaying the object immediately after screen changing in XGT Panel, the object is displayed based on the previously communicated value even if communication is not completed. In this case, the value displayed on the object may be different from the actual controller value until communication 1 scan is complete.</p>
<p>Switch Action Setting on XP- Runtime</p>	<p>Synchronous mode:</p> <ul style="list-style-type: none"> • The method of synchronize external input processing and communication operation in the conventional way. • If the communication operation is performed by external input, other external input processing is impossible before the communication operation is completed.

Auxiliary Settings	Description
	Asynchronous mode: <ul style="list-style-type: none"> • The method of handling communication operation and external input processing separately. • If the communication operation is performed by external input, other external input operation is possible before the communication operation is completed. • In asynchronous mode, there is no guarantee of multi switch operation order. • Applies only to bit switches, word switches, and multi switches.
Smooth edges of font (Except eXP Series)	Change the text-shaped options displayed on the XGT Panel. <ul style="list-style-type: none"> • Anti-aliasing: Text is displayed smoothly. • ClearType: The text shape is clearly displayed.

Note

- Click [Server Settings] ► [E-mail] to configure the email settings.

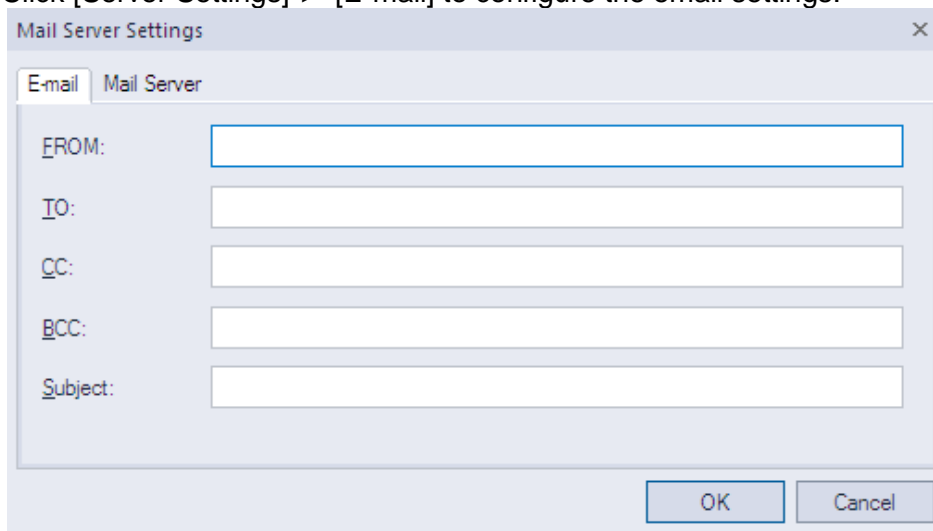

Function	Description
From	Set the sender. You can specify only one sender.
To	Set the recipient. Use a semicolon (;) to divide the email addresses between multiple recipients.
CC	Set the secondary recipient(s). Use a semicolon (;) to divide the email addresses between multiple recipients.
BCC	Set the hidden secondary recipient(s). The addresses in this field will not be shown on the email content. Use a semicolon (;) to divide the email addresses between multiple recipients.
Subject	Enter the subject of an email. You can enter up to 128 Latin characters.

- Click [Server Settings] ► [Mail Server] to configure the email server.

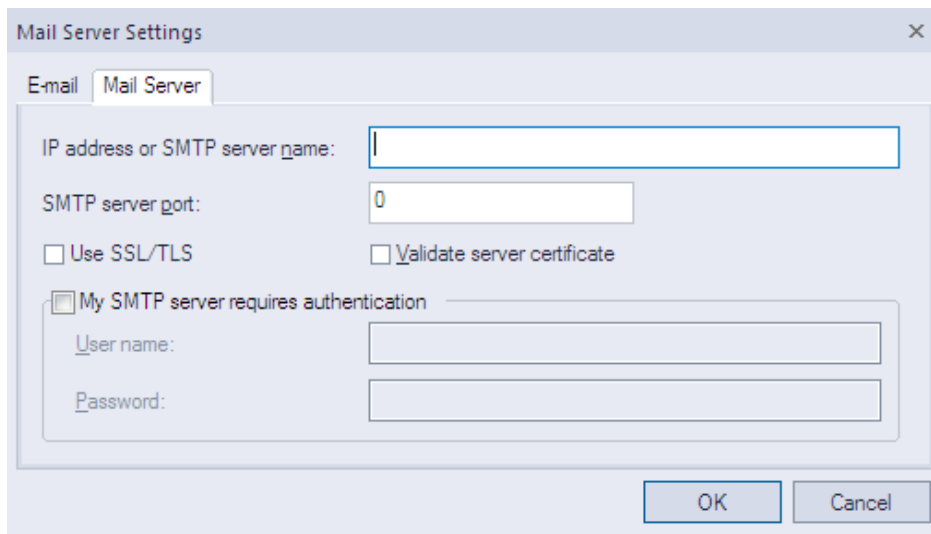

Function	Description
IP Address or SMTP Server Name	Enter the IP address or SMTP server name.
SMTP Server Port	Enter the port number of the SMTP server. If you use an anonymous SMTP account service in the intranet, the port number is 25.
Use SSL/TLS	Encode data when transferring it to the mail server.
Validate Server Certificate	View the certificate of the mail server.
My SMTP Server Requires Authentication	Unless you use an anonymous SMTP mail service in the intranet, you need authentication for the user information.
User Name	Set the name for authentication.
Password	Set the password for authentication.

- To configure the Mail Server Settings using an Anonymous SMTP, the mail server must be on the same intranet as the XGT Panel.
- The email is encoded in Unicode. Set the port number to 25 in this case (25 is the default port number for Anonymous SMTP service).
- To use the mail server URL instead of an IP address in the Mail Server Settings, you must set the DNS server IP in the XGT Panel Start menu.

2.2.3 Editing default settings

You can edit default settings in XP-Builder.

2.2.3.1 Changing default editing options

Change the editing options. Click [TOOL] ► [Option] ► [Edit Option].

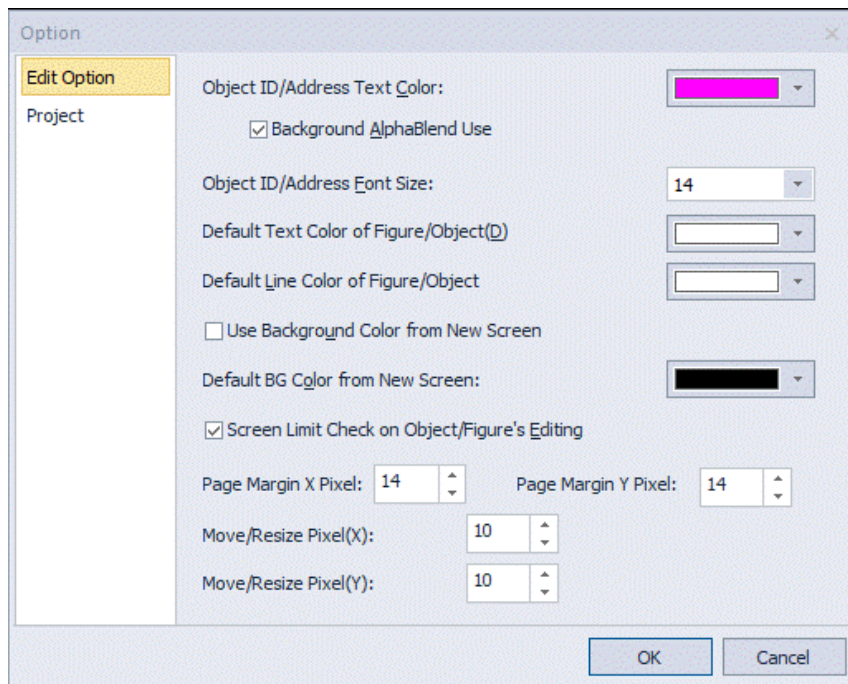

Item	Description
Object ID/Address Text Color	Set the default color for device and object IDs. The setting is applied immediately.
Background Alpha Blend Use	Set a semi-transparent background for device or object IDs. The setting is applied immediately.
Object ID/Address Font Size	Set the default font size for device and object IDs. The setting is applied immediately.
Default Text Color of Figure/Object	Set the default font color for character strings in figures or objects. The setting is applied when you create new figures or objects.
Default Line Color of Figure/Object	Set the default line color for character strings in figures or objects. The setting is applied when you create new figures or objects.
Use Background Color from New Screen	Set a background color to use for new screens. The setting is applied when you create a new screen.
Default BG Color from New Screen	Select the default background color. The setting is applied when you create a new screen.
Screen Limit Check on Object/Figure's Editing	Prevents figures and objects from extending beyond the boundaries of the editing area. The setting is applied immediately.

Item	Description
Page Margin X	Set the screen's margin line on the X axis by pixel.
Page Margin Y	Set the screen's margin line on the Y axis by pixel.
Move/Resize Pixel(X)	Set the pixel size for moving or resizing an object using the arrow keys on the X axis.
Move/Resize Pixel(Y)	Set the pixel size for moving or resizing an object using the arrow keys on the Y axis.

2.2.3.2 Changing default project options

To edit project management properties, click [TOOL] ► [Option] ► [Project].

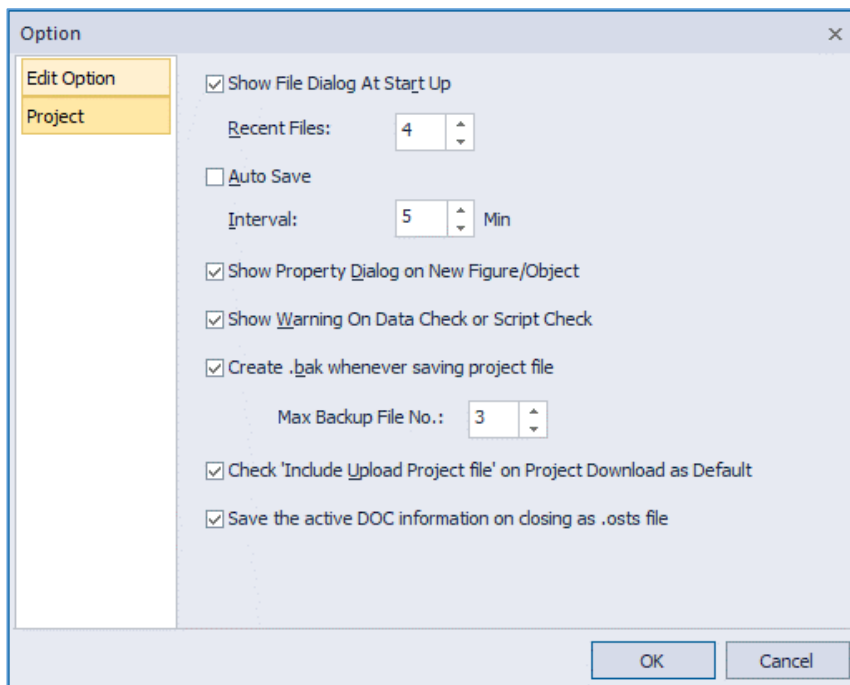

Item	Description
Show File Dialog at Start Up	Set whether or not to show the Select Project screen when you launch XP-Builder.
Recent Files	Set the maximum number of recent files to show.
Auto Save	Set whether or not to save project files automatically.
Interval	Set how often XP-Builder will automatically save project files. The default unit is minutes.
Show Property Dialog on New Figure/Object	Set to show the properties window when you create a new figure or object.
Show Warning On	Set whether or not to show a warning message and list of errors in the

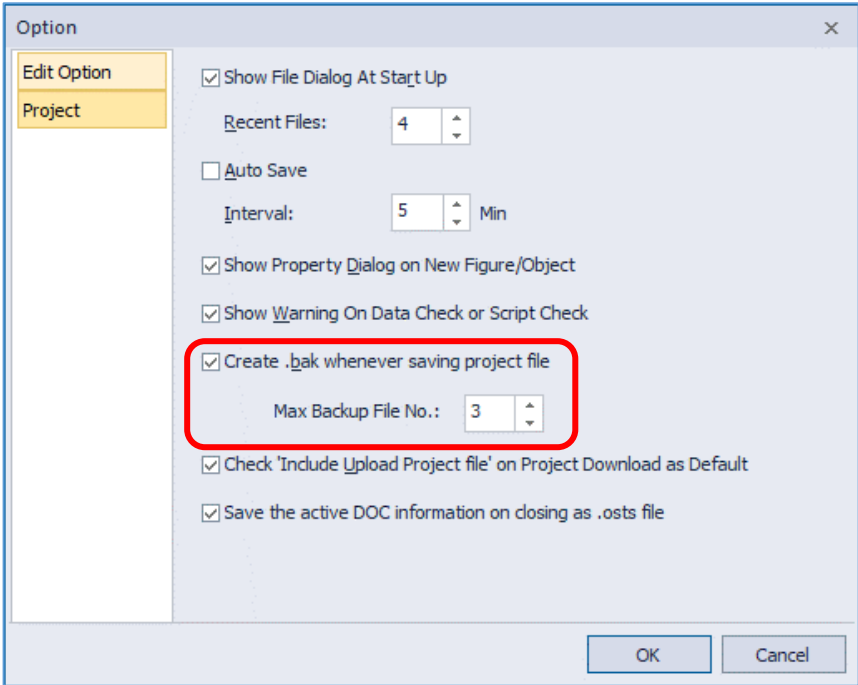
Item	Description
Data Check or Script Check	<p>following instances. If you do not use this option, only the warning message will appear.</p> <ul style="list-style-type: none"> • When you run a data check ([TOOL] ► [Data Check]). • When you download a project file to an XGT Panel. • When you run a script check ([TOOL] ► [Script Check]).
Create .bak Whenever Saving Project File	<p>This option determines if an existing project will be saved as a “.bak“ file when a project file is created. If this option is checked, the content of an existing project file is saved as a BAK file before a new project file is saved. Changes to the project’s data are saved in an XPD file. If the option is unchecked, the BAK file is not created, and the project is saved only as an XPD file.</p>
Max Backup File No.	<p>You can set XP-Builder to create up to ten backup files. The extensions for the backup files are “.bak” and “.bak1–bak9.” Click [TOOL] ► [Option], [Project] to adjust the number of backup files.</p> 
Check 'Include Upload Project file' on Project Download as Default	<p>Check to select the “Check ‘Include Upload Project file’ on Project Download as Default” feature. This option is selected by default. When this option is selected, the ‘Include Upload Project File’ option is applied by default. Uncheck this option to manually decide whether to include the upload project each time you download a project.</p>
Save the active DOC information on closing as .osts file	<p>When closing, the screen window setting information of the last XP-Builder is saved.</p>

2.3 Developing an Interface

You can use different types of screens when creating a project, and draw or insert figures, objects, and graphs on screens. The following table describes available screen types.

Type	Description
Base Screen	<ul style="list-style-type: none"> The main area for drawing and editing a project. The screen size varies by XGT panel model.
Window Screen	<ul style="list-style-type: none"> Windows that overlap or pop-up on the Base screen. A project can support up to 65,534 screens, but screens 65,531-65,534 are reserved for system key information. You can insert figures and objects, and up to eight window objects (16 window objects for the eXP2/iXP/iXP2/IPC series). To view the bit device status (on or off), click [VIEW] ► [Show/hide Object On/Off]. To view the word device status for the screen number assigned to the conditional statement, change the value of the word status combo box on the toolbar. A shift key does not appear on Window screens by default. To activate the shift key, click anywhere on the Window screen. Refer to <4.3.5 Window Objects> for detailed information.
Key Window	<ul style="list-style-type: none"> Key windows are pre-defined Window screens that allow you to insert four types of keypads: decimal, ASCII, hexadecimal, and float. To use a user-defined keypad, use the Special Switch Function or import one of the provided object libraries, and then insert it into the screen. To change the key window settings, click [COMMON] ► [Project Property Setting] ► [Key Window Settings].
Part Screen	<ul style="list-style-type: none"> You can use a Part screen to control how figures (such as lines, circles, and images) behave on a Base screen. Drag and drop the Part screen from the Screen pane to the editing area to copy all objects from the Part screen into the Base screen. The Part screen is used as a part of the part object, the bit part, and the word part. You can create up to 65,534 Part screens. You cannot register an object to a Part screen. Refer to <4.3.6 Part Objects> for detailed information.
HDMI Screen	<ul style="list-style-type: none"> You can only create HDMI screen on models that support HDMI You can create an HDMI screen by switching from [Project property] ► [Screen Settings] ► [HDMI Screen Setting]. You can create up to 1 to 65534 screens per HDMI connection. You can set initial screen and screen resolution in [Project Property] ► [Screen Settings] ► [HDMI Screen Settings]

Global window settings allow you to define up to two windows that can be activated across the entire interface, based on device values. To set the addresses for the global windows, click [COMMON] ► [Project Property Setting] ► [Screen Settings].

Note

A project can support a total of 65,534 Base, Part, or Window screens. However, Window screens 65,531-65,534 are reserved for decimal, HEX, ASCII, and real keypads, respectively. You can adjust the size of a Base screen, but not the sizes of other screens.

2.3.1 Adding Screens

You can insert three types of screens from the Screen pane. You can also drag and drop a Base, Window, or Part screen onto a Base screen. When you insert a Base or Window screen, the screen itself will be inserted. When you insert a Part screen, the objects on the Part screen will be copied to the Base screen. The following table describes how to add screens:

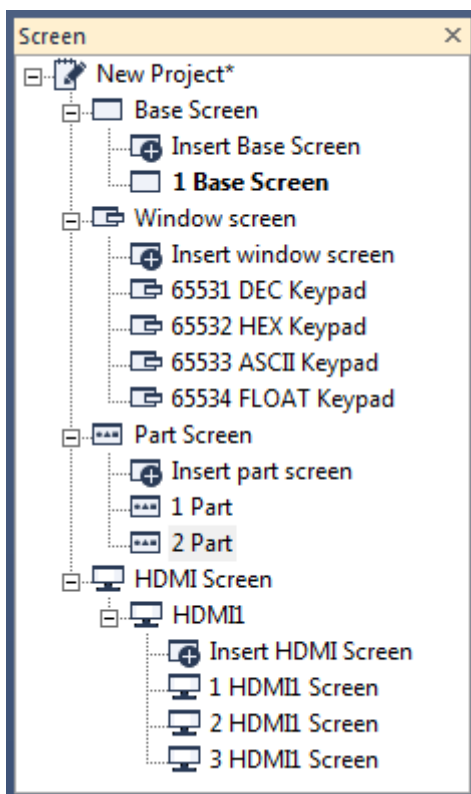

Type	Description
Base Screen	Right-click [Base Screen] and click [Insert].
Window Screen	Right-click [Window Screen] and click [Insert].
Part Screen	Right-click [Part Screen] and click [Insert].
HDMI Screen	Right-click [HDMI Screen] and click [Insert] Double-click [Insert HDMI Screen].

2.3.2 Configuring Screens

XP-Builder allows you to customize screen properties, such as which screen appears when the interface is started from the XGT panel.

2.3.2.1 Opening or Closing a Screen

To open a screen, double-click the screen name in the Screen pane. To close a screen, right-click the screen name and click [Close].

To view thumbnails of all the project screens, click [VIEW] ► [Screen Thumbnails].

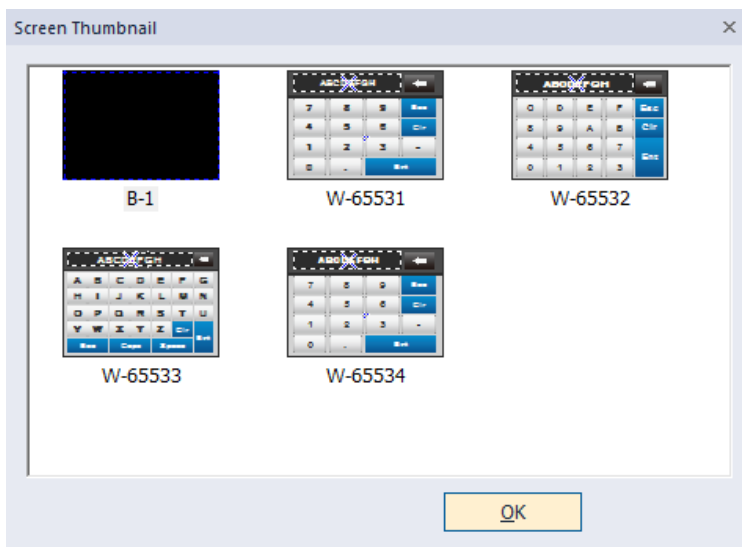

2.3.2.2 Setting a Screen as the Start Screen

The start screen is the screen that appears when the interface is run on the XGT Panel. The start screen must be a Base screen, and it will appear in boldface in the Screen pane.

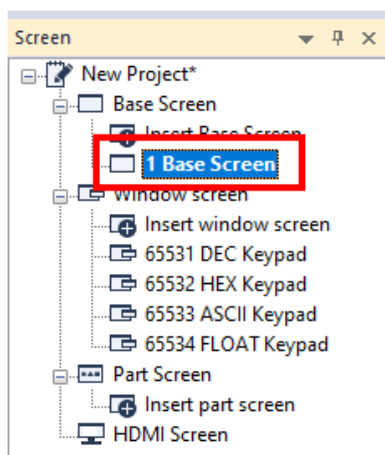

To set the start screen:

- 1 In the Screen pane, right-click one of the Base screens.
- 2 Click [As Startup Screen].

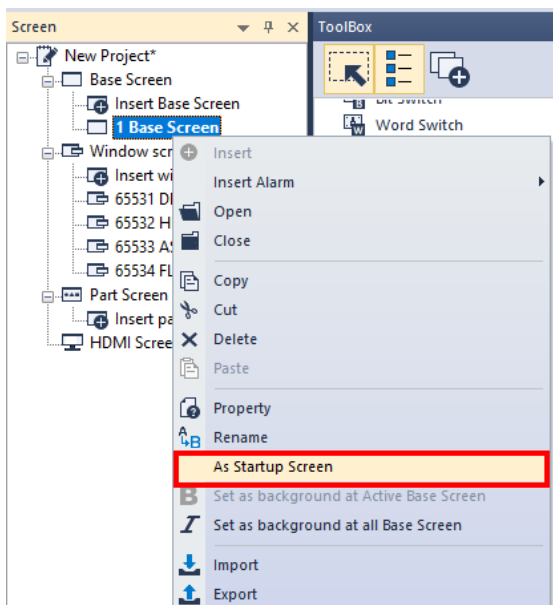

2.3.2.3 Renaming a Screen

- 1 In the Screen pane, right-click a screen.
- 2 Click [Rename].

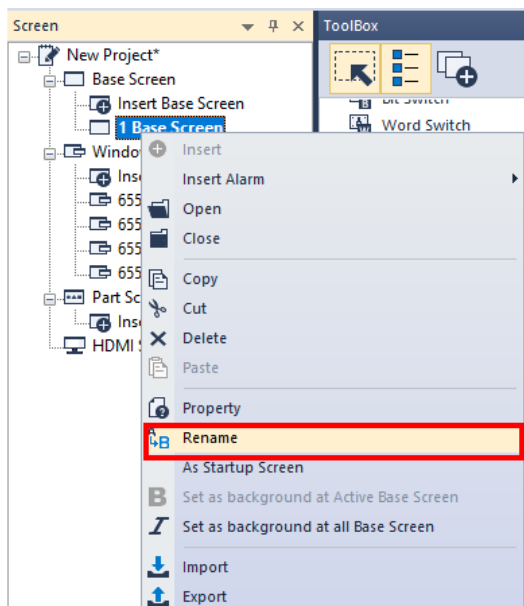

- 3 Enter a new name and press the Enter key.

Note

- Screen names are composed of numbers, spaces, and text characters. You must separate the screen number and name with a space or the screen name will not be recognized (for example, if you enter “1Base screen,” the name will not be recognized).
- Keypad windows have fixed numbers: DEC (65531), HEX (65532), ASCII (65533), and FLOAT (65534).
- On the screen pane, you can select multiple screens and change the screen property options at the same time. Click the screens while holding down the Ctrl or Shift key to select multiple screens, and then right-click over the selected screen to open the context menu and select [Property].

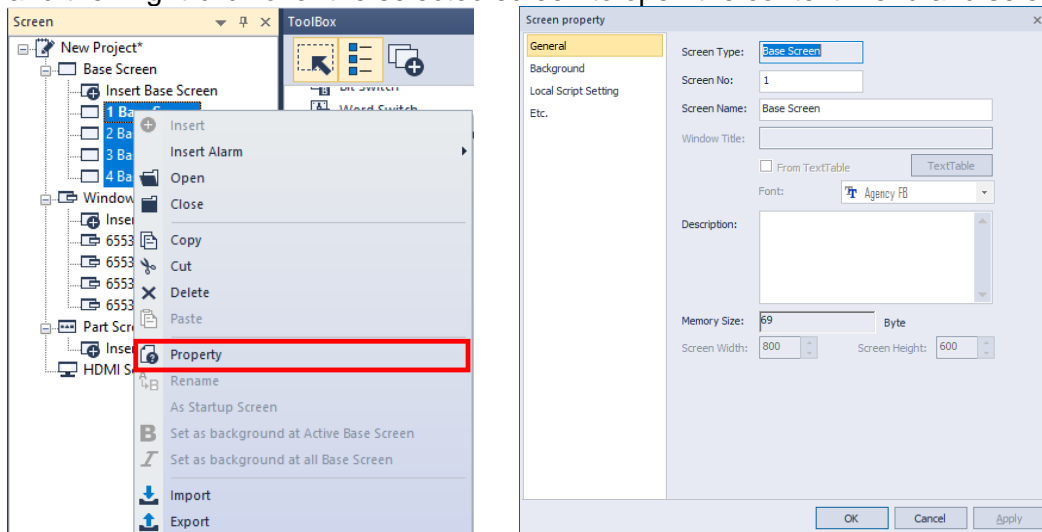

2.3.2.4 Changing Screen Properties

- 1 Right-click anywhere on a Base screen.
- 2 Click [Screen Property].

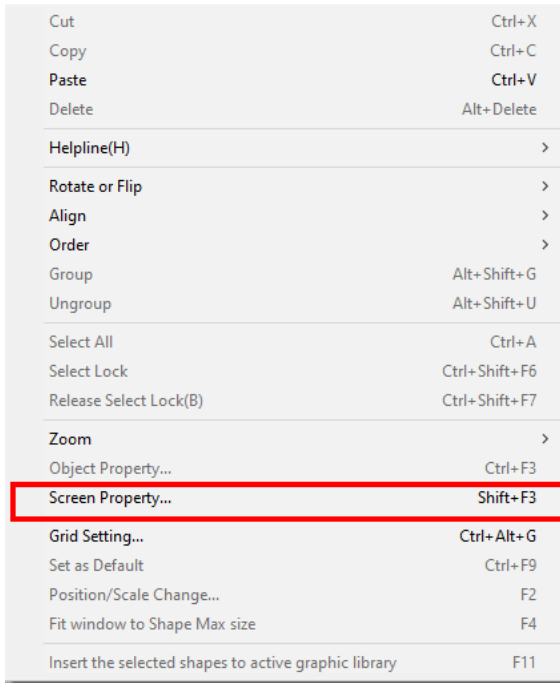

- 3 Set the following properties:

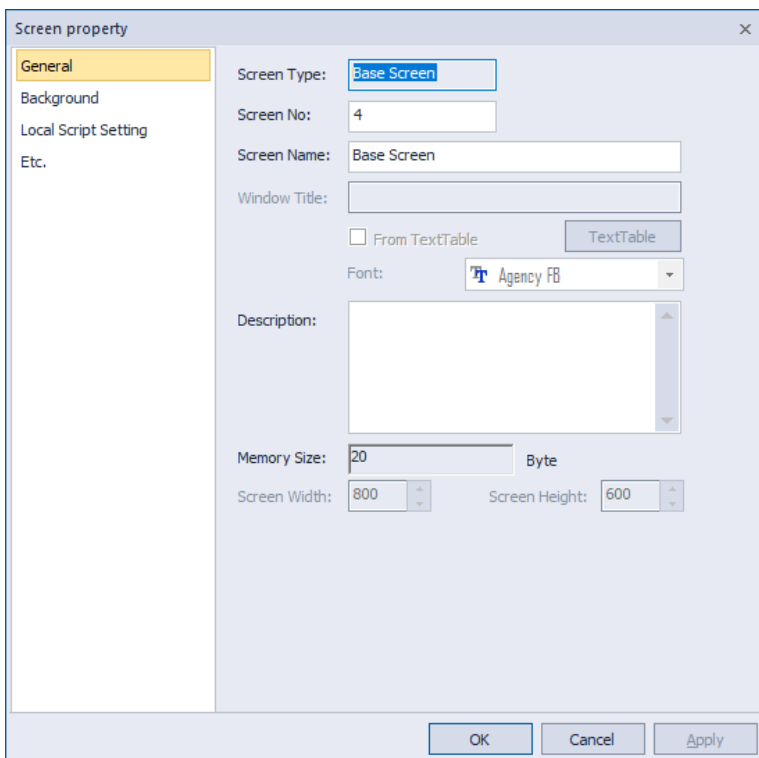

Category	Description
General	<ul style="list-style-type: none"> • Set basic information, such as type, number, name, or screen size. If you specify window titles from a text table, the text will be applied, but additional font properties will not. The window titles will appear in a fixed format: white, 15-point font. • To change properties for multiple screens at the same time, hold the Ctrl key and click the screen names. Then, right-click any of the selected screen names and click [Property]. The values you specify will be applied to all the selected screens at the same time.
Background	<ul style="list-style-type: none"> • Set the background pattern, color, or image. To select a background image from your computer, check the checkbox next to Use BG Image, click [Library], and then locate the image file. For more information, refer to <2.4.1 Managing Graphic Libraries>. • You can set a background to include a color and image, but the color setting takes priority over the image setting. • Supported background image formats include BMP, JPG, GIF, TGA, PNG, TIF, WMF, ICO, and PCX. The BTE and TTE models support only BMP, GIF, JPG, and WMF formats.
Local Script Setting	<ul style="list-style-type: none"> • Set scripts to execute when the Base screen appears or switches. The script is executed according to the selected condition when the screen changes. • Scripts must be created before they can be applied to screens. For more information about scripts, refer to <4.2 Scripts>. • To apply a script, select a script name and execution condition, and then click [Insert]. • You can specify an execution condition for a script (Consecutive, Periodic, On Bit Rising, On Bit Falling, or On Bit Changed) or specify a device to control the execution of the script.
Etc.	<ul style="list-style-type: none"> • Check the checkbox next to Run Script at Open Screen or Run Script at Close Screen, and select a script for each case. • Check the checkbox next to Show Flow Alarm to set whether or not to show flow alarms at the bottom of the XGT Panel screen.

Note

Although an execution condition is fulfilled while processing a script, there might be a slight delay because the conditions are rechecked after the script is completed.

4 When you are finished configuring properties, click [OK] to save your changes.

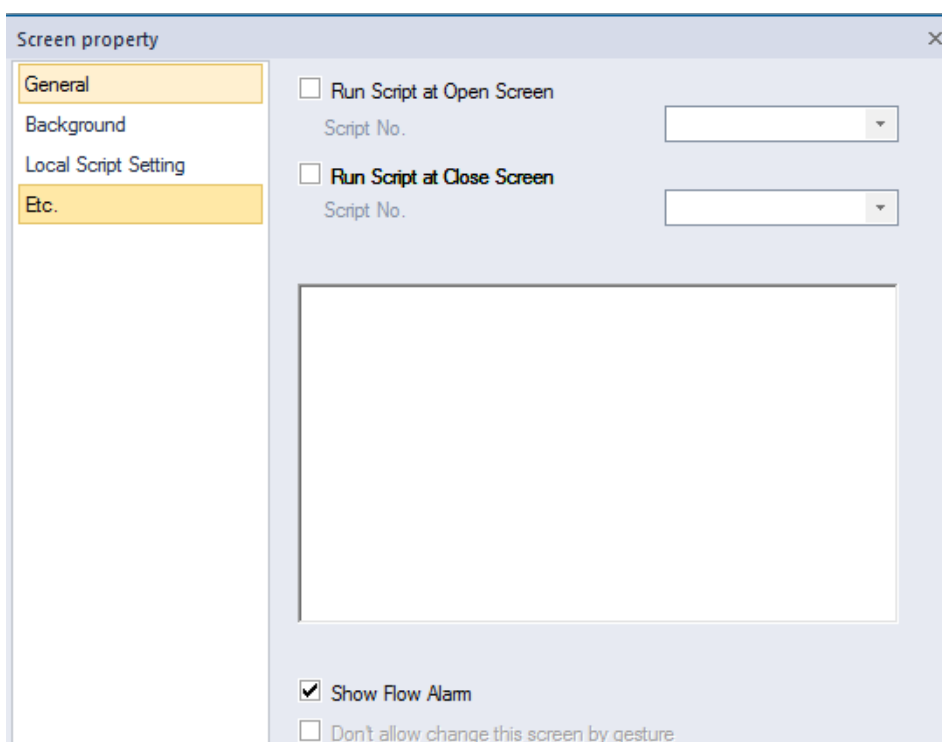

2.3.3 Editing Screens

You can edit the screens with standard functions, such as cut, copy, and paste. To edit windows:

- 1 In the Screen pane, right-click a screen name.
- 2 Click an option, such as [Copy], [Paste], [Cut], or [Delete].
- 3 Click [OK] (if necessary).

Note

When you paste a screen into the project, you can set the number of the screen.

2.3.4 Inserting Figures or Objects

You can add figures, objects, or text to screens. You can also set properties, such as width, height, color, or pattern, and insert images from the graphic library.

2.3.4.1 Drawing Figures

You can draw figures, such as lines, circles, and rectangles.

To draw a figure:

- 1 In the Toolbox pane, click [Figure].

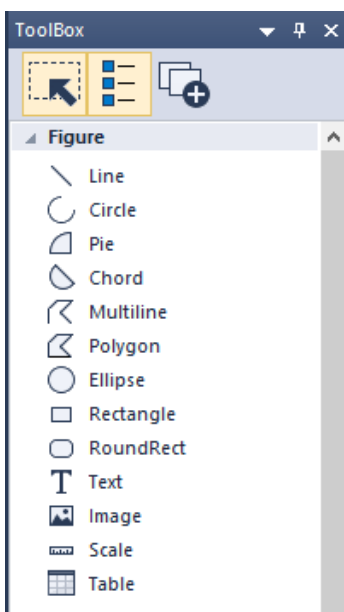

- 2 Click a figure type.
- 3 Click the editing area and specify options for the figure.

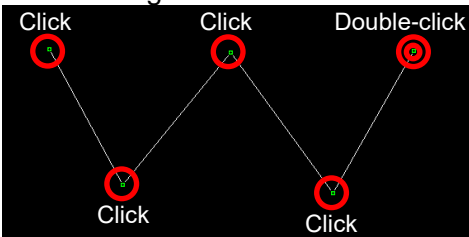
Type	Description
Line Multiline	<ul style="list-style-type: none"> To draw multiple lines, click multiple points and then double-click to insert the figure.  <ul style="list-style-type: none"> To delete part of a multiline, press and hold the Ctrl key while clicking a point.

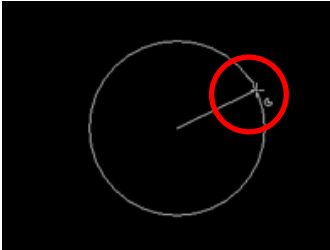
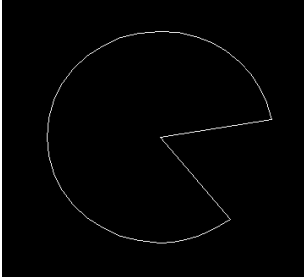
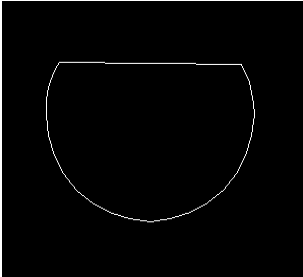

Type	Description
	<div style="display: flex; justify-content: space-around;">  </div> <ul style="list-style-type: none"> To draw a line, drag the line on the editing area. If you want to draw a straight line, press and hold the Shift key while dragging.
Circle Pie Chord Ellipse Rectangle RoundedRectangle	<ul style="list-style-type: none"> To draw a perfect circle or square, press and hold the Shift key while dragging. To draw a figure from the center point, click the figure, and then click [EDIT] ► [First Point As Center] on the toolbar. <div style="background-color: #003366; color: white; padding: 2px; margin-bottom: 10px;">Note</div> <p>When you enable the First Point As Center option, it is applied to all the screens in the same project.</p> <ul style="list-style-type: none"> When drawing circles, pies, or chords, draw a circle first, then click the circle to mark the start and end points. <div style="display: flex; justify-content: space-around; align-items: center;">  </div> <ul style="list-style-type: none"> Draw the circle again until you complete the circle, pie, or chord. <div style="display: flex; justify-content: space-around; align-items: center;">   </div> <div style="display: flex; justify-content: space-around; margin-top: 5px;"> <Pie> <Chord> </div> <ul style="list-style-type: none"> To draw an ellipse, rectangle, or rounded rectangle, click and draw the figure.
Polygon	<ul style="list-style-type: none"> To draw a polygon, click multiple points and then double-click to insert the figure.

Type	Description
	<div data-bbox="454 331 1066 770" data-label="Diagram"> </div> <ul data-bbox="421 779 1385 846" style="list-style-type: none"> • To delete part of the multiline, press and hold the Ctrl key while clicking a point. <div data-bbox="454 846 1136 1070" data-label="Image"> </div>
Image	<ul data-bbox="421 1093 1332 1205" style="list-style-type: none"> • To import images from the System Graphic Library or User Graphic Library, refer to <2.4.1 Managing Graphic Libraries>. • To change an image, double-click it.
Scale	<ul data-bbox="421 1227 1361 1451" style="list-style-type: none"> • You can select the location and direction (horizontal or vertical) of scales. • Set the scale properties, including the number of tick marks, tick size, and tick intervals. • Set the appearance of the scale with the color options. • You can create a table with the scale.
Text	<ul data-bbox="421 1478 1382 1585" style="list-style-type: none"> • Draw a text box on the screen, and then enter text in the text input box. • To insert text from a text table, check the check box next to From Text Table, and then click [Text Table].
Table	<ul data-bbox="421 1612 1230 1724" style="list-style-type: none"> • You can set the number of rows and columns. • You can set adjust the spacing between rows and columns. • You can set the line color, line style, and line thickness.

4 When you are finished specifying figure properties, click [OK].

Note

- The default size of figures varies by figure type.
- You can apply 28 types of textures to figures, except for line, multiline, image, scale and text figures.
- Monochrome XGT panels do not support texture for the objects or figures.
- The textures displayed by an XGT panel may differ slightly from their appearance in XP Builder.

2.3.4.2 Inserting Images from the Graphic Library

You can insert images from the Graphic Library. For more information about the Graphic Library, refer to **<2.4.1 Managing Graphic Libraries>**.

To insert images from the Graphic Library:

- 1 Click [VIEW] ► [Graphic Library].

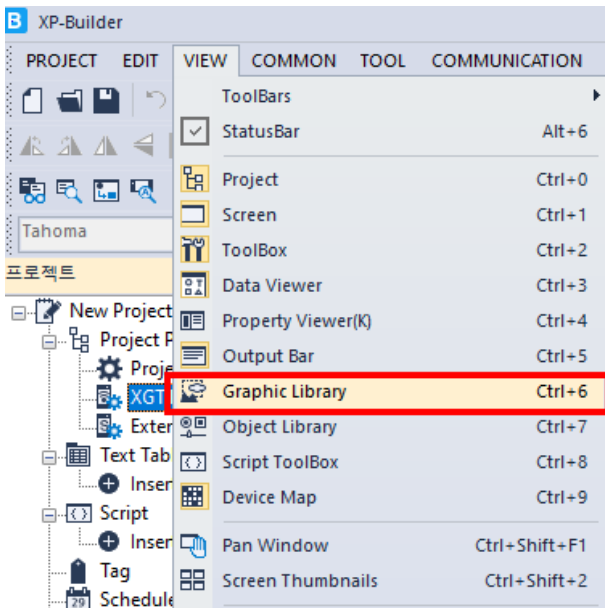

- 2 In the Graphic Library pane, click the System or User tab, and then click an object category from the drop-down list.

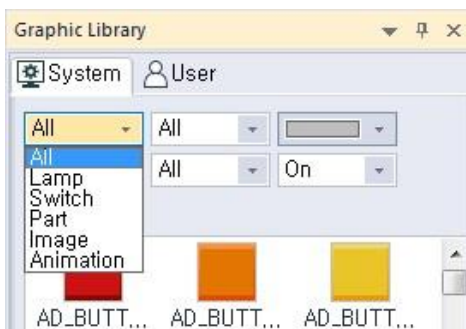

- 3 In the Graphic Library pane, drag and drop an image onto the editing area.

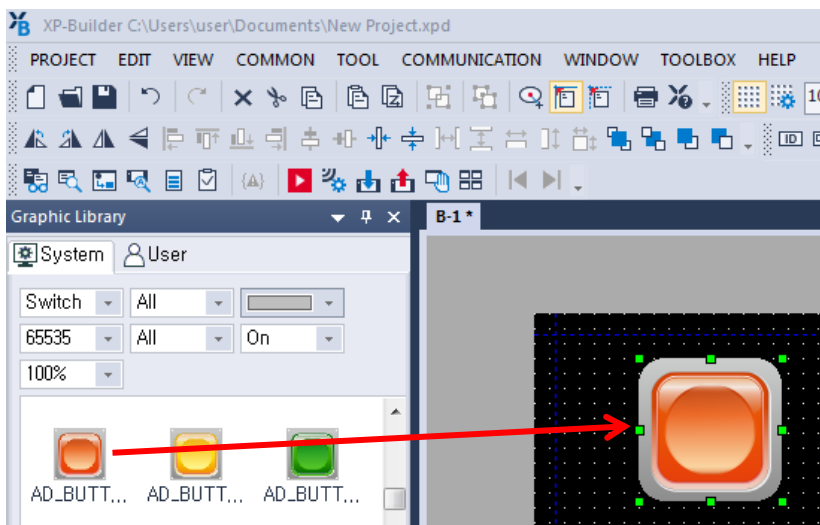

2.3.4.3 Drawing Objects

You can draw objects, such as switches, windows, parts, and graphs. These objects are the most important components for operating a control system based on device values or condition. For more information about objects, refer to **<2.4.2 Managing Object Libraries>**.

To draw an object:

- 1 In the Toolbox pane, click [Object].
- 2 Click an object type.
- 3 Click or drag in the editing area and specify options for the figure:

Type	Drawing Options
Bit/Word Switch Change Screen Switch Special Switch Multi Switch Bit/Word Lamp N-State Lamp Clock Bit Message Word Message Numeric Display Numeric Input Text Display Text Input Animation	Draw the object in the editing area or click the editing area to insert the object in its default size.
Bit Window Word Window	<ul style="list-style-type: none"> • To draw the object, click a point in the editing area. • The sizes of these objects are fixed.
Bit Part	<ul style="list-style-type: none"> • Choose a movement type, such as [Fixed], [XY],

Type	Drawing Options
Word Part	<p>[Line], or [Route].</p> <ul style="list-style-type: none"> • Draw a line or route method, similar to a line or multiline figure respectively. • The sizes of these objects are fixed, but the line and route types are customizable.
Bar Graph Pie Graph Meter Graph Trend Graph Logging Trend Graph Scatter Graph	<p>Draw the object in the editing area or click the editing area to insert the object in its default size.</p>
Closed Graph	<ul style="list-style-type: none"> • Choose a graph type: Ellipse or Polygon. • Draw the closed graph, based on the ellipse or polygon-type you selected. When drawing a polygon-type closed graph, click multiple points to draw the polygon then double-click the drawing to complete it.
History Alarm Viewer Datalist Logging Viewer Alarm Navigator MemoPad Explorer Datalist Editor File Recipe Editor PDF Viewer VNC Viewer Multimedia FTP Client Slider	<ul style="list-style-type: none"> • Draw the object in the editing area or click the editing area to insert the object in its default size. • The size of the Logging Viewer or Datalist is fixed.

4 When you are finished editing properties, click [OK]. To change the properties of an object, double-click it.

Note

- The following table describes limits when creating objects.

Type	Limit
History Alarm Viewer	1: You can insert only one object per screen.
Logging Viewer	
Alarm Navigator	
Bit Window	You can create up to 8 or 16 pop-up windows on one screen. - XP/eXP series: 8 - eXP2/iXP/iXP2/iPC series: 16
Word Window	
MemoPad	1: You can insert only one object per screen.
Recipe Navigator	<ul style="list-style-type: none"> 1 for basic recipe 1 for file recipe You can choose the recipe type in the properties window. If you exceed the limit, an error will occur when transferring the project to a panel.
Datalist Editor	1: You can insert only one object per screen.
File Recipe Editor	
Figure and other objects	Unlimited

- An object cannot be created when:
 - It is inserted in a Part screen
 - A Window object is inserted into a Window screen
 - One of the following objects is already on the screen:
Alarm Viewer, Logging Viewer, Alarm Navigator, Logging Trend Graph, Datalist Editor, File Recipe Editor, MemoPad, PDF Viewer, VNC Viewer object

2.3.4.4 Inserting Objects from the Object Library

You can insert figures or objects from the Object Library. For more information about libraries, refer to [<2.4 Managing Libraries>](#).

To insert images from the Graphic Library:

- 1 Click [VIEW] ► [Object Library].

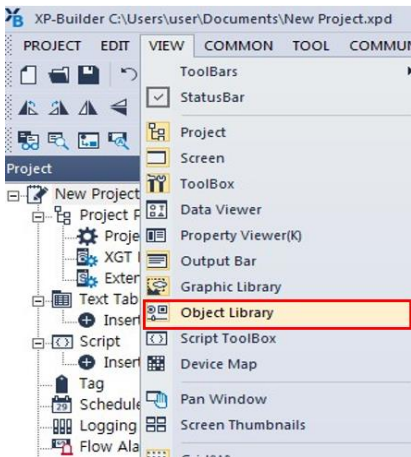

- 2 In the Object Library pane, click a desired tab, and then click an object category.

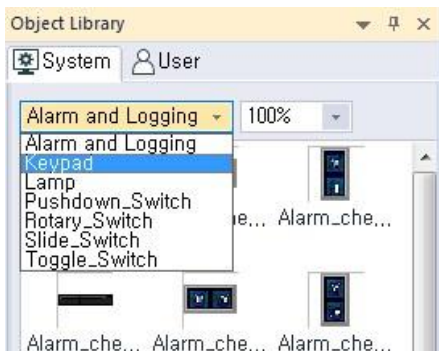

- 3 In the Object List, drag and drop an object into the editing area.

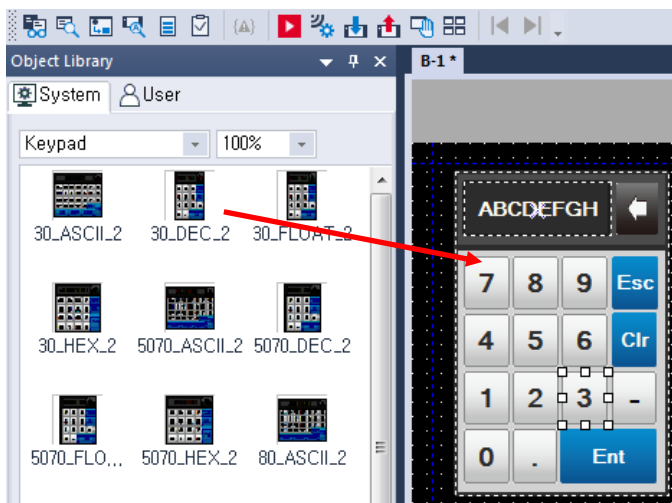

- 4 Double-click the object and change the properties if necessary.
- 5 When you are finished changing properties, click [OK].

2.3.5 Editing Objects

Learn how to edit objects that you have inserted into a project.

2.3.5.1 Selecting Objects

You can move, resize, copy, paste, or delete objects, or adjust the object properties after making selections. XP-Builder provides several options to help users select the on-screen components more efficiently.

Basic Selections

- You can select an object on the screen by clicking on it.
- To select multiple objects, drag the pointer over the objects on the screen, or press and hold the Ctrl or Shift key while clicking the objects.

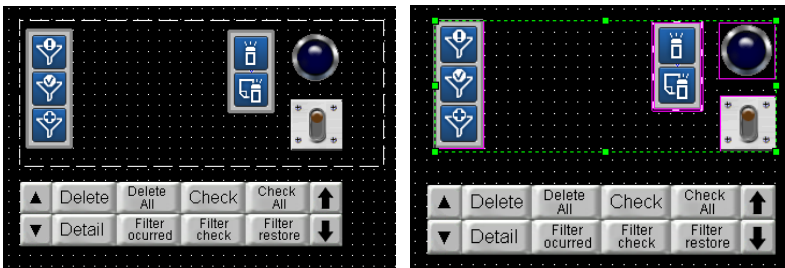

- If you drag the pointer to the right and downwards, only the objects which are completely covered by the rectangle will be selected.

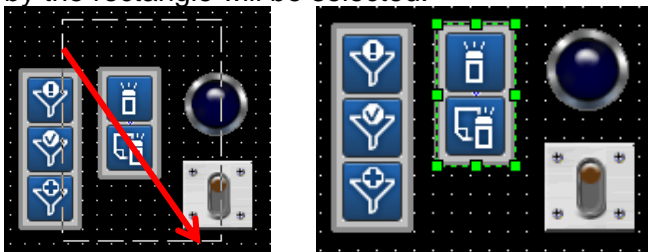

- If you drag the pointer to the left and upwards, the objects in the rectangle and other objects partially covered by the rectangle are selected together.

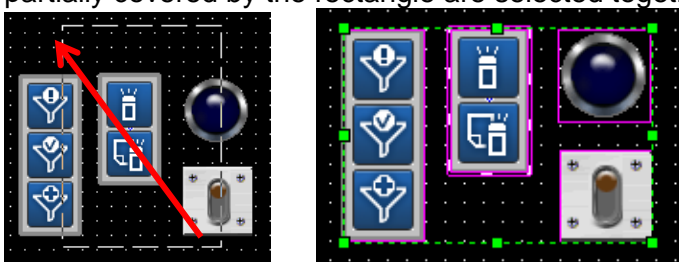

- To select all of the objects on a screen at once, click [EDIT] ► [Select All], or press “Ctrl+A.”

Note

Inside a selection, you can decide the primary object by clicking one of the selected objects while pressing the Ctrl key.

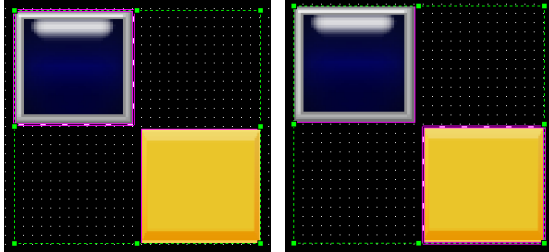

When you arrange a selection of multiple objects, the objects are aligned based on the position of the primary object in the selection.

Selecting Overlapping Objects

To select one of the overlapping objects, right-click the front object while pressing the Ctrl key. Then continue right-clicking while pressing control to cycle through the selection of objects individually from front to back.

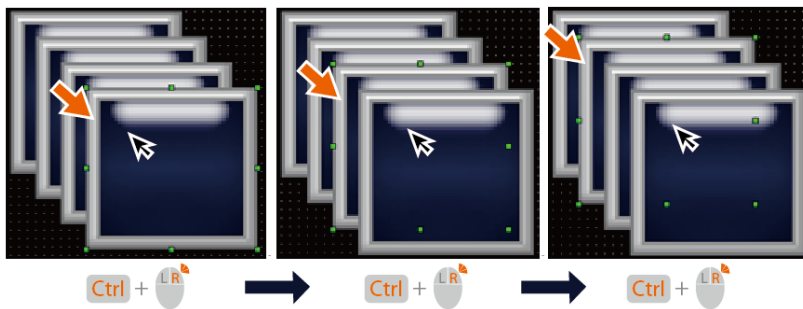
**Note**

- When you cycle through the selection of overlapping objects in a group, the cycle takes place only within the boundary of the group.
- To select an object that is hidden behind another object or to select an overlapping area between multiple objects, press the Alt key while you drag the pointer to make a selection.

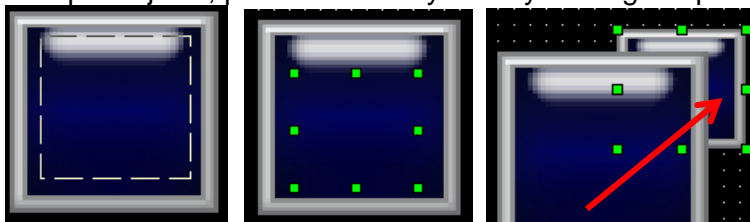

- When you select an object that is overlapped by another object, the selection is maintained when you click on the overlapped area.

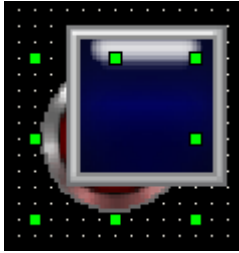

Canceling a Selection

To cancel a selection, click an empty area on the screen, or press and hold the Alt or Shift key while clicking anywhere on the screen.

2.3.5.2 Grouping and Ungrouping Objects

You can edit multiple objects more easily by grouping them first.

To group objects:

- 1** Select multiple objects.
- 2** Right-click the selection and click [Group].

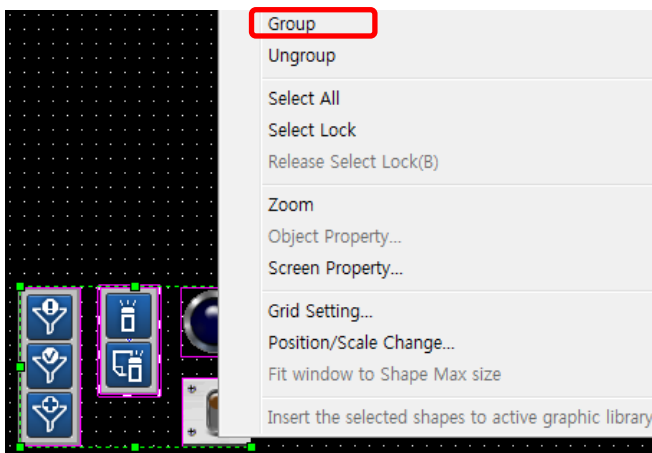

To ungroup objects:

- 1** Select a group.
- 2** Right-click the selection and click [Ungroup].

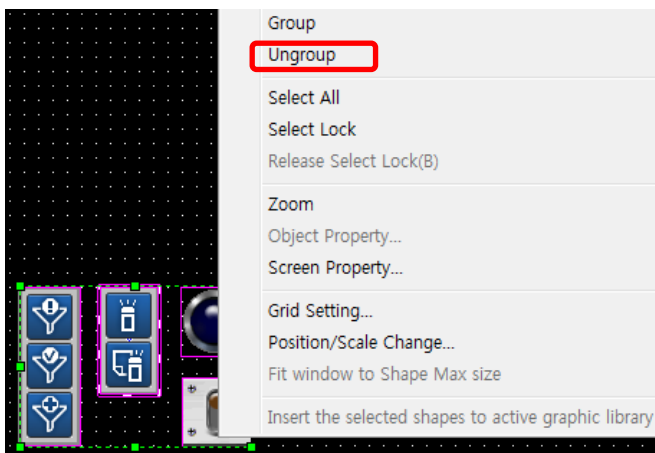

Note

- To select an object inside a group, click the object for 0.5 seconds. A selection is made when you release the mouse button.

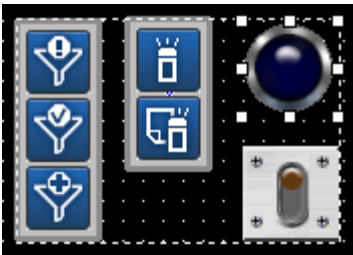

- After selecting an object in a group, you can click and select other objects in the same group.

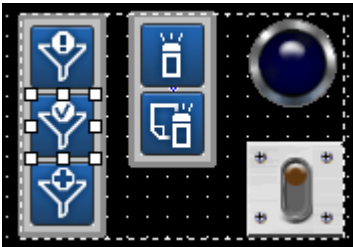

2.3.5.3 Locking and Unlocking Objects

You can lock or unlock objects to enable or disable the selection.

To lock objects:

- 1 Select the objects to lock.
- 2 Right-click the selection and select 'Select Lock' from the menu.

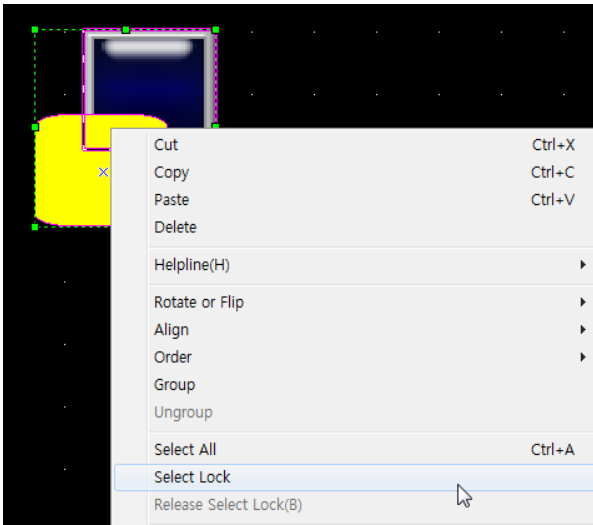

To unlock objects:

- 1 Right-click the locked object(s).
- 2 Select 'Release Select Lock' from the menu.

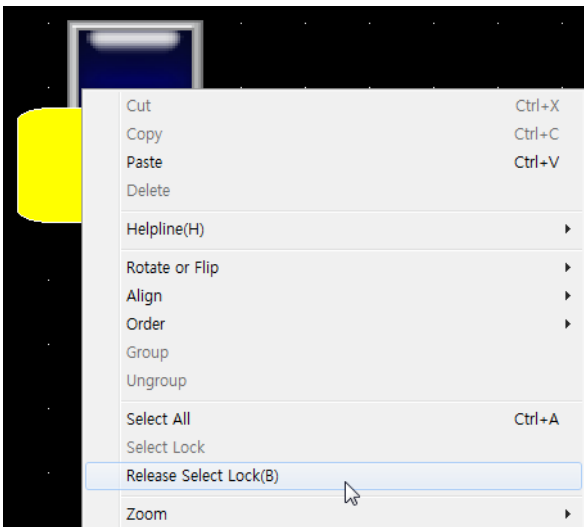





Note

- To disable selection lock for all objects and figures on the screen, on the main menu, click [EDIT] ► [Release Selection Lock of All Objects and Figures on Screen].



- You can enable or disable the selection lock from the Data Viewer by clicking

the lock icon on the right side of the object information.

Shape Name	Object ID	Position	
Bit Switch	SB00001	(60,50,180,170)	
Bit Switch	SB00002	(130,40,290,190)	
Word Switch	SD00001	(190,30,360,200)	
MultiAction Swi...	SM00001	(250,10,390,230)	
Clock	CL00001	(330,300,510,380)	

- You can lock or unlock a group but not the individual objects inside a group. Ungroup the objects to lock or unlock the individual objects in a group.

2.3.5.4 Copying Multiple Objects

You can use the Multicopy function to insert multiple objects with the same properties.

- 1 Select multiple objects.

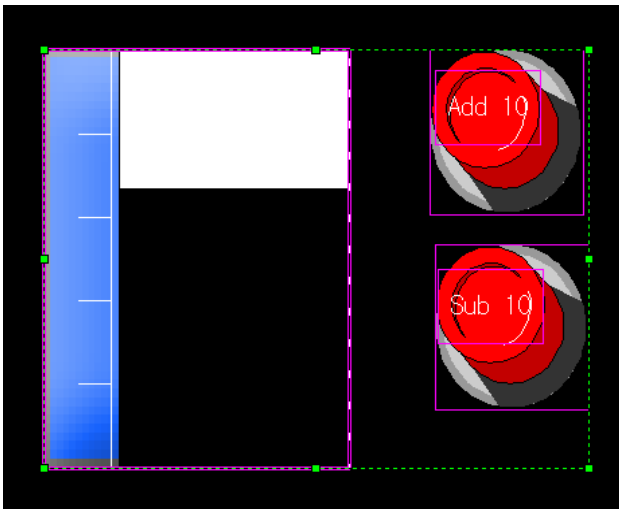

Note

You can copy and paste different objects at the same time.

- 2 Click [EDIT] ► [Multi Copy].
- 3 Specify the following properties as desired:

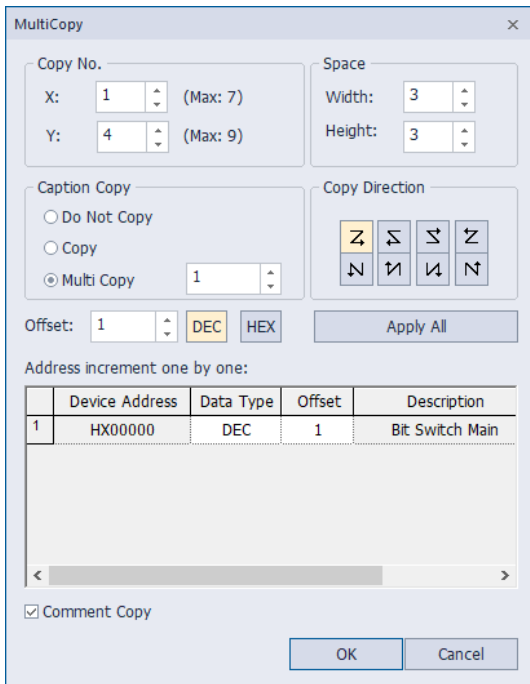

Type	Description
Copy No.	Set how many objects to paste by specifying the number of rows and columns of the new objects. The number of rows and columns cannot exceed the maximum number displayed on the screen. Also, this setting cannot be applied if “Screen Limit Check on Object/Figure’s Editing” is checked under [TOOL] ► [Option] ► [Edit Option].
Space	Set the vertical and horizontal space between each object.
Copy Direction	Set the pasting direction of new objects.
Caption Copy	<p>- Do Not Copy: The object is copied, but only the address is copied, and the text string is not used.</p> <p>- Copy: The address of the object increases as much as the [Offset] value, and the text string is copied without increasing.</p> <p>- Multi Copy: Text is also copied with increment values. For example, it works as follows.</p> <ul style="list-style-type: none"> • If the currently selected object’s text string is a direct text. Creates and copies a text string that has increased as much as [Offset] in the entered text string. (Ex. If the string is “Bit 1” and [Offset] is 1, the string is created and copied in order of “Bit 2” and then “Bit 3”.) • If the text string of currently selected object is a text table: The selected text table: The selected text number is copied by increasing [Offset]. (Ex. After selecting the string number 1, if [Offset] is 1, the number is copied by incrementing each of 2, 3, 4...)

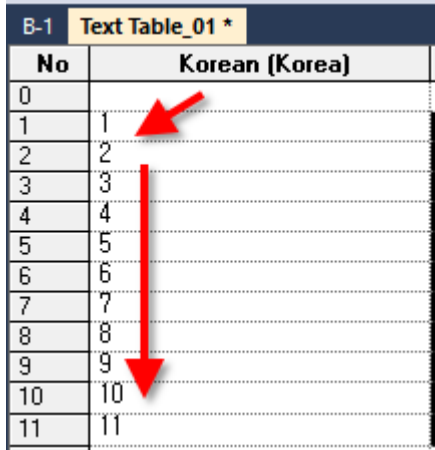
Type	Description
	
Comment Copy	Set to copy the description of an object.
Offset	Set an offset to specify the new device addresses automatically.
Apply All	Set to apply the offset number to every object.
Address Increment one by one	Apply a different offset to each device. If you want to paste objects with different addresses, set the offset number manually.

4 Click [OK].

Note

- If the number of input columns or rows exceeds the maximum number, the objects cannot be copied.
- You cannot copy tags with the Multicopy function.

2.3.5.5 Arranging Objects

You can arrange objects or change the drawing order in the editing area. The last object created is shown at the top level. When you arrange a selection of multiple objects, the objects are aligned based on the position of the primary object in the selection.

To arrange objects:

- 1 Select multiple objects on the screen.

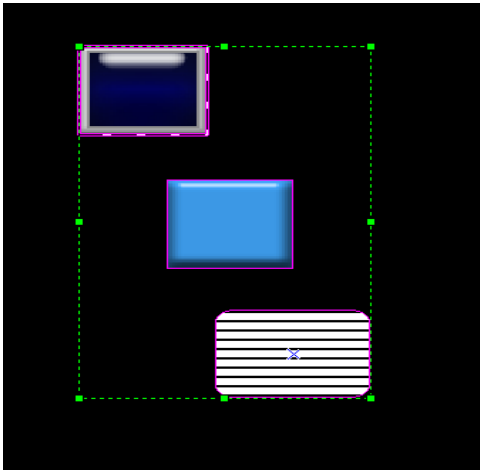

- 2 Right-click the selection.
- 3 Click [Align] and select an alignment option.

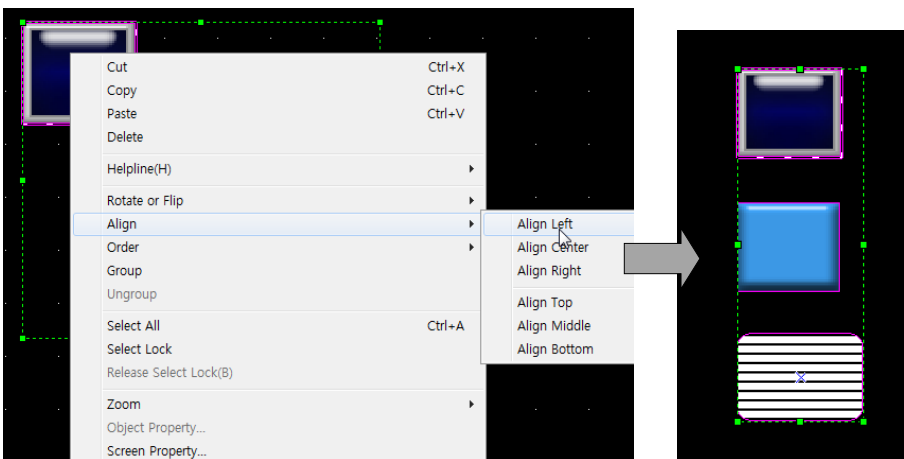

Note

- You cannot align the individual objects in a group. Right-click the grouped objects and click [Ungroup] before aligning the objects on the screen.
- You can also move all of the objects to the center of the editing area. Select the objects to move, and then click [EDIT] ► [Center in Page] ► [Horizontal] or [Vertical].

To change the drawing order:

- 1 Right-click an object.
- 2 Click [Order] and select an order option.

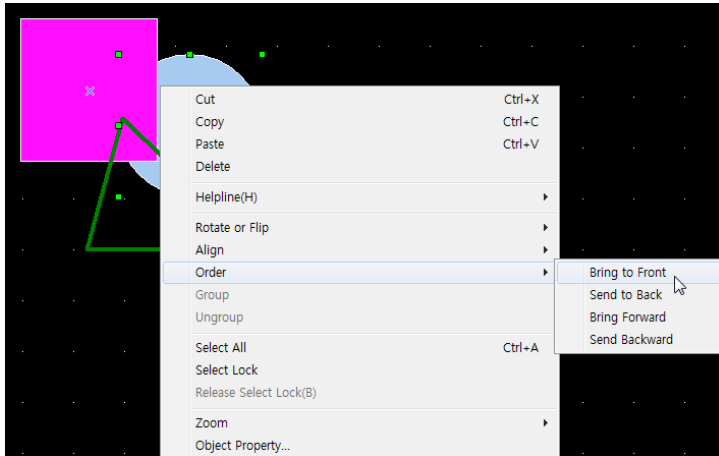

- The object order is changed.

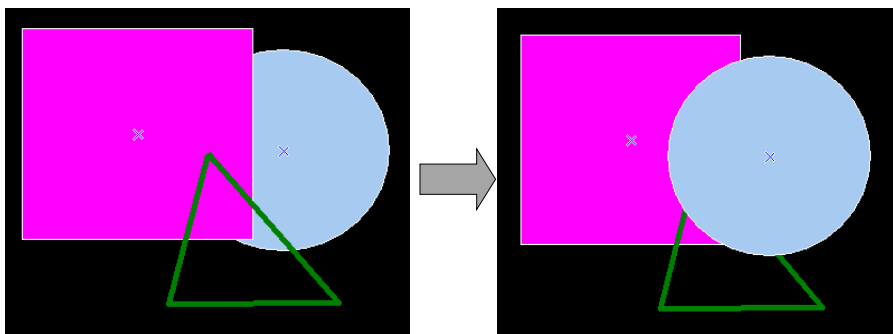

2.3.5.6 Rotating Objects

You can rotate or flip objects in a desired direction.

To rotate objects:

- 1 Right-click an object.

2 Click [Rotate or Flip] and select a rotation or flip option.

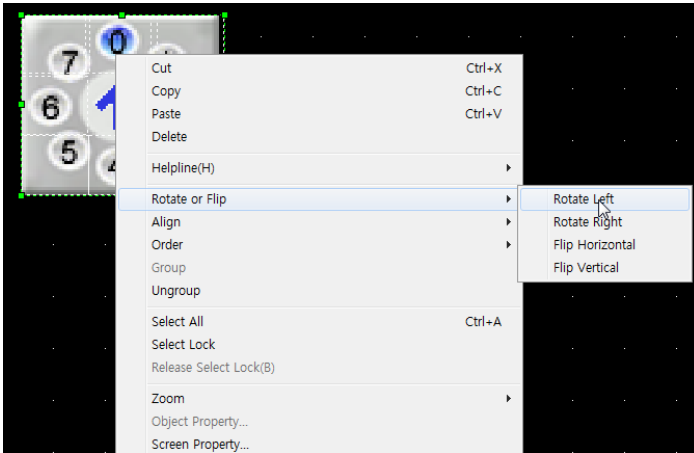

- The object is rotated or flipped.

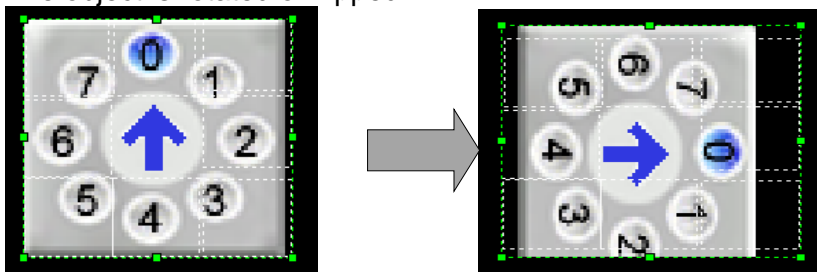

Object types	Availability for Rotation and Flipping
Switches (5 types)	Supports rotation and flipping. Captions cannot be flipped.
Lamps (3 types)	Images and captions can be rotated. Captions cannot be flipped.
Clock	Images and the time display can be rotated. The time display cannot be flipped.
Message objects (2 types)	Background images and messages can be rotated. Messages cannot be flipped.
Text and numeric objects	Background images and numeric characters can be rotated. Numeric characters cannot be flipped.
Part and window objects	Supports neither rotation nor flipping.
Animation objects	Supports neither rotation nor flipping.
Graph objects(9 types)	Background images can be rotated, but the direction of the graph does not support rotation or flipping.

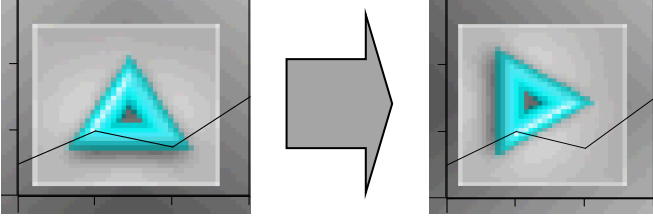
Object types	Availability for Rotation and Flipping
	
History alarm viewer, data list, alarm navigator, memo pad, file recipe editor, data list editor, PDF viewer, VNC viewer	Supports neither rotation nor flipping.

Note

- The XP30-BTE, XP30-TTE, XP40-TTE, and XP50-TTE models do not support font rotation.

2.3.5.7 Resizing or Relocating Objects

You can resize or relocate objects.

To resize or move objects:

- 1 Right-click an object.
- 2 Click [Position/Scale Change].

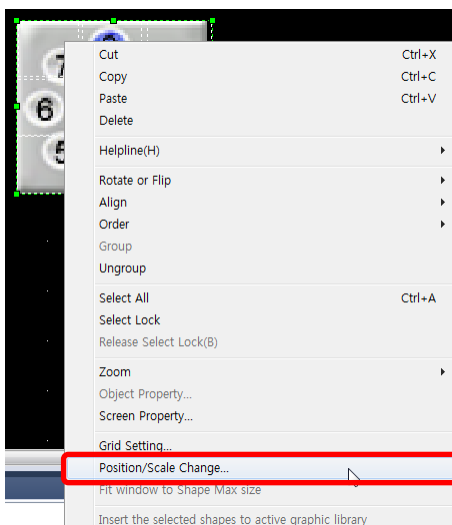

- 3 Set values for a new location or size. You can move an object to a precise position or specify its size.

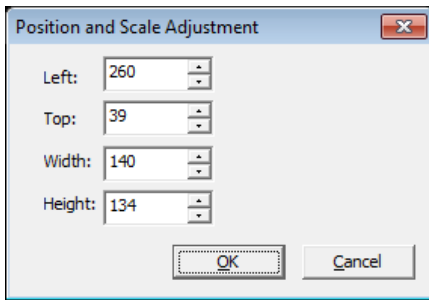

Note

- To move an object by one pixel, select an object, and then press the desired arrow keys.
- To resize an object by single pixel increments/decrements, press the desired arrow keys while pressing the Shift key.
- You can configure a preset value (number of pixels) for moving and resizing object. Go to [TOOL] ► [Option] ► [Edit Option], **adjust Move/Resize Pixel(X) and Move/Resize Pixel(Y)** values, and then:
 - To move an object by the preset number of pixels, press the desired arrow keys while pressing the Ctrl key.
 - To resize an object by the preset number of pixels, press the desired arrow keys while pressing the Ctrl and Shift keys.
- To resize an object while maintaining a fixed center point, hold the Ctrl key while resizing an object.
- To resize an object while maintaining the same ratio, hold the Shift key while resizing an object.
- Certain objects, such as Logging Viewer, Datalist, and Window/Part objects do not support resizing. They are provided by the system in fixed sizes.

4 Click [OK].

To resize multiple objects:

- 1 Select the objects to resize.

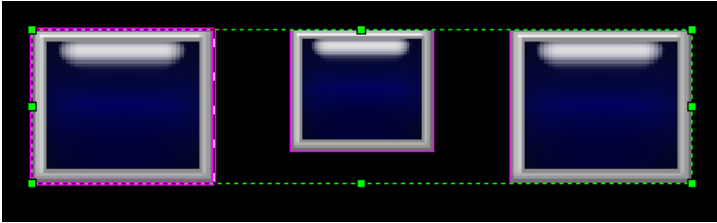

- 2 Click [EDIT] ► [Make Same Size] ► [Width], [Height], or [Both].

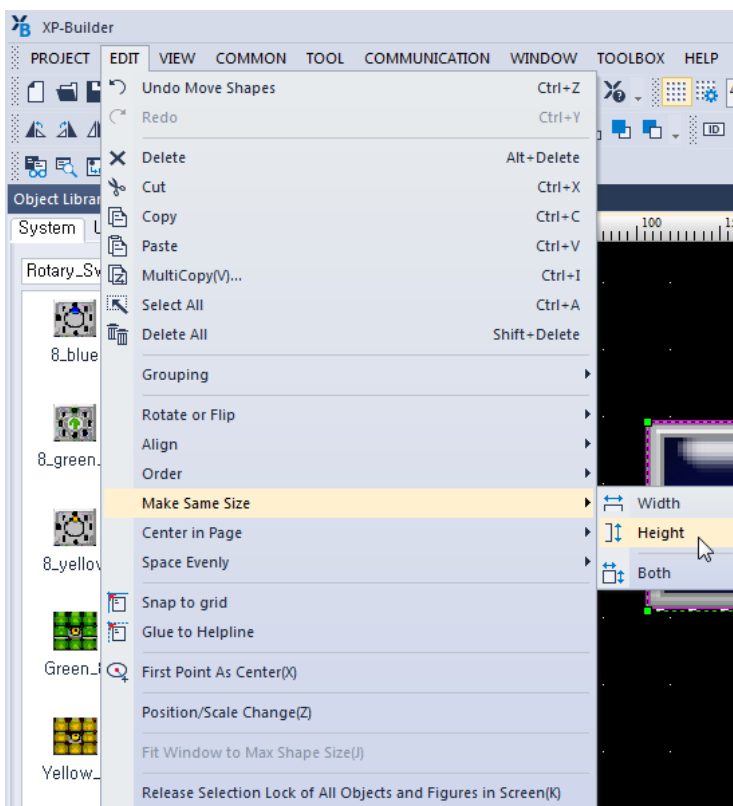

- The objects are all resized in the same way.

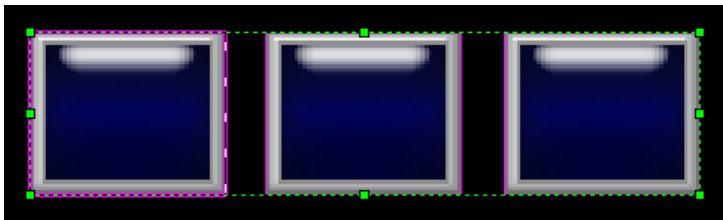

To space objects evenly:

1 Select multiple objects.

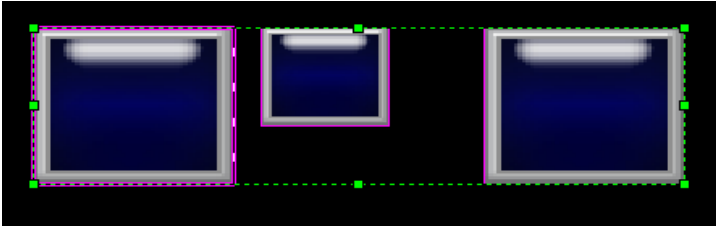

2 Click [Edit] ► [Space Evenly] ► [Across] or [Down].

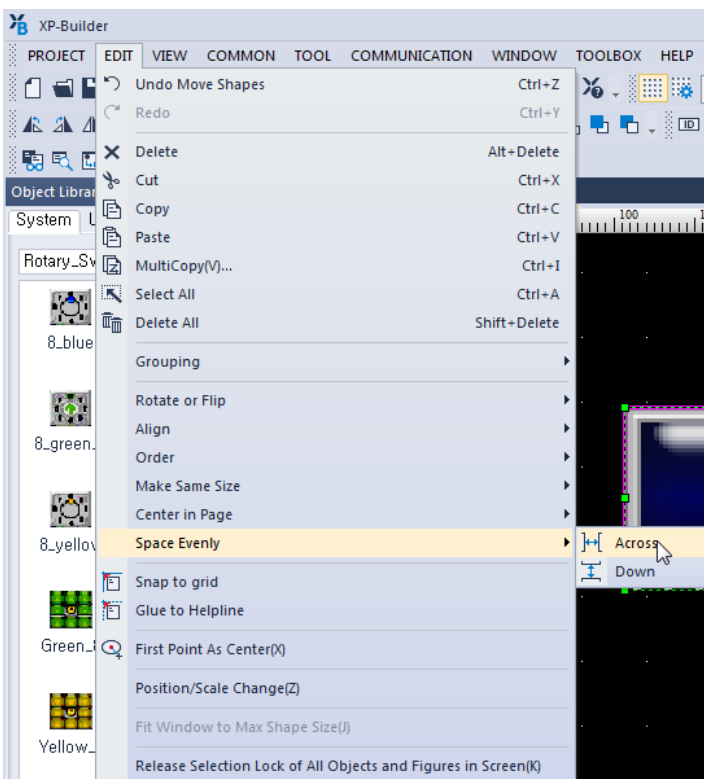

• The objects are all spaced evenly.

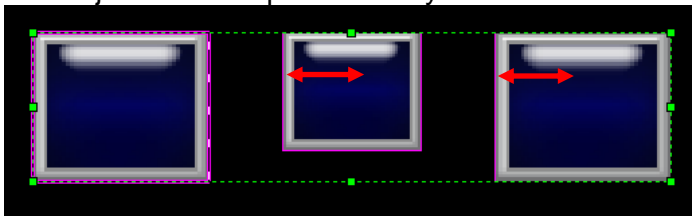

2.3.5.8 Setting Viewing Options

You can set viewing options as described in the following table:

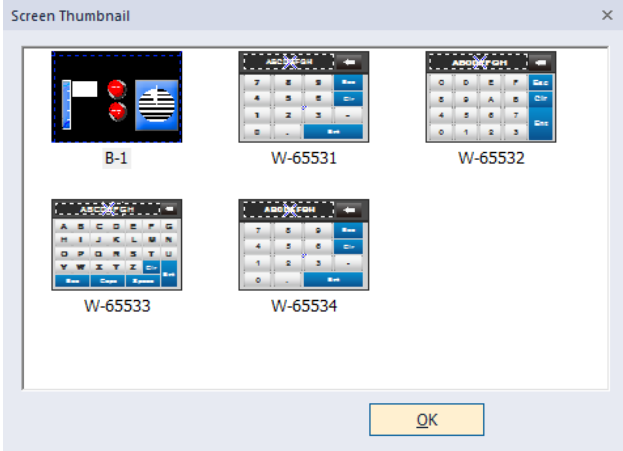
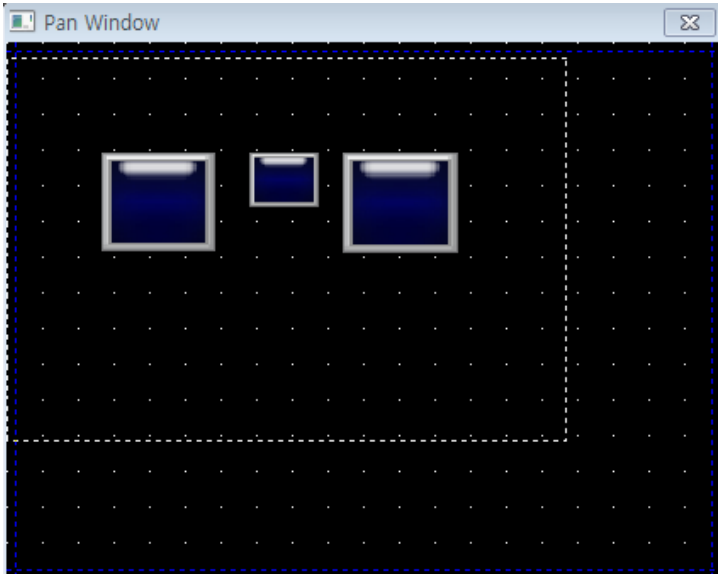
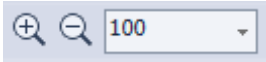
Type	Description
Thumbnail	<ul style="list-style-type: none"> You can show all screens in a project on a single screen. Double-click a screen to select it. Click [VIEW] ► [Screen Thumbnails]. 
Pan Window	<ul style="list-style-type: none"> You can view the current screen in a birds-eye view and scroll through the screens. Click [VIEW] ► [Pan Window]. 
Zooming	<ul style="list-style-type: none"> You can zoom in or out on the current screen. Click the magnifier icon on the toolbar. You can also enter a magnification percentage in the toolbar or select one of the presets (50%-400%) in the dropdown list. 
Property Viewer	<ul style="list-style-type: none"> You can view and edit information about windows, figures, or objects on the

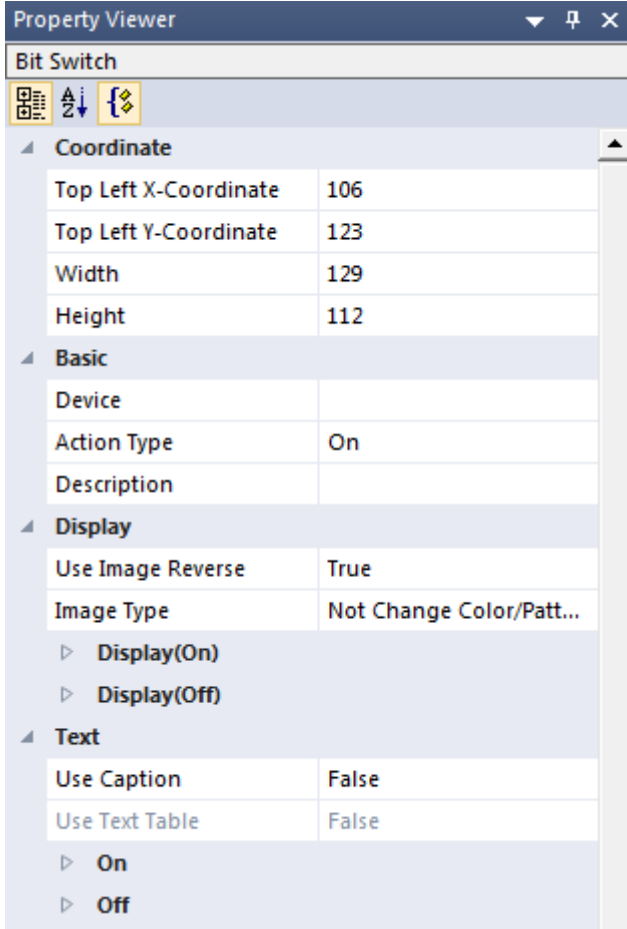

Type	Description
	<p>current screen without opening a dialog box.</p> <ul style="list-style-type: none"> Click [VIEW] ► [Property Viewer], then select an object or screen. 

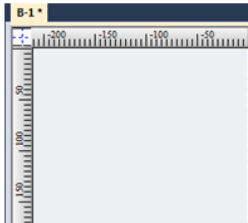
You can also set options for the editing area, as described in the following table:

Type	Description
Ruler	<ul style="list-style-type: none"> To show or hide the ruler, click [VIEW] ► [Ruler]. Scales are displayed in pixels. 
Grid Setting	<ul style="list-style-type: none"> You can move and arrange objects conveniently with the grids in the editing area. To show or hide gridlines, click [VIEW] ► [Grid].

Type	Description
	 <ul style="list-style-type: none"> You can set the color, width, and height of the dots on the grid. To change the settings, click [VIEW] ► [Grid Setting].  <ul style="list-style-type: none"> You can also change settings to display the dots over or below the objects from the Grid Setting.  <ul style="list-style-type: none"> To allow an object to snap to the nearest intersection of lines in the grid while moving or resizing it, click [EDIT] ► [Snap to grid]. To disable or enable the Snap to grid function during moving or resizing an object, press the Alt key while moving or resizing an object.
Margin Line	<ul style="list-style-type: none"> The margin line is the boundary of the editing area.  <ul style="list-style-type: none"> To show or hide the lines, click [VIEW] ► [Margin Line]. To set the margin sizes, click [TOOL] ► [Option], and then select Edit Option.

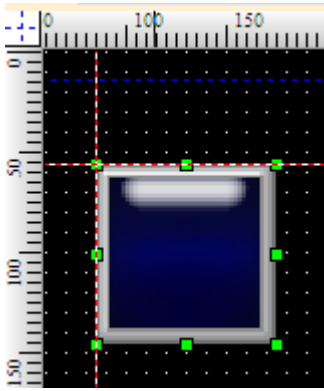
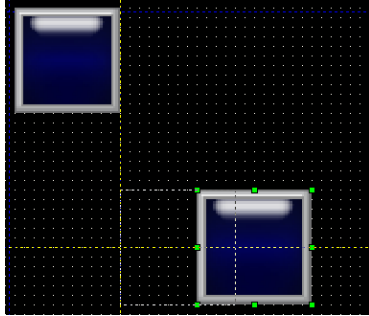
Type	Description
<p>Help Line</p>	<div data-bbox="470 338 1236 786" data-label="Image"> <p>The screenshot shows the 'Option' dialog box with the following settings:</p> <ul style="list-style-type: none"> Object ID/Address Text Color: [Color Picker] <input checked="" type="checkbox"/> Background AlphaBlend Use Object ID/Address Font Size: 14 Default Text Color of Figure/Object: [Color Picker] Default Line Color of Figure/Object: [Color Picker] <input type="checkbox"/> Use Background Color from New Screen Default BG Color from New: [Color Picker] <input checked="" type="checkbox"/> Screen Limit Check on Object/Figure's Editing Page Margin X: 14, Page Margin Y: 14 Move/Resize Pixel(X): 5 Move/Resize Pixel(Y): 5 </div> <ul style="list-style-type: none"> • The help line is used as a reference when you draw or arrange objects on the screen. <div data-bbox="466 884 823 1189" data-label="Image"> <p>This image shows a dark background with a blue rectangular object in the center. Red dashed lines form a crosshair around the object, representing help lines used for alignment.</p> </div> <ul style="list-style-type: none"> • To show or hide the help lines, click [VIEW] ► [Help Line]. • To draw help lines, move the pointer to the border of the screen frame, and then drag the line to the editing area. <div data-bbox="470 1317 769 1447" data-label="Image"> <p>The diagram shows a horizontal and a vertical help line. Small arrows on the lines indicate that they can be moved horizontally and vertically.</p> </div> <ul style="list-style-type: none"> • To lock or unlock the help lines, right-click the line and then click [Help Line] ► [Lock Help Line]. • To delete a help line, right-click the line and then select [Help Line] ► [Delete Help Line]. • To allow an object to be attached to the help lines while moving or resizing it, click [EDIT] ► [Glue to Help Line].

Type	Description
Guide line	 <ul style="list-style-type: none"> • When you move an object on the screen, the guidelines are displayed to provide additional guidance about the object's position in relation to the object's previous position or the position of other objects on the screen. The guidelines are displayed when the moving object and an existing object are aligned in the center, edge, intersection, etc. • To show or hide the guidelines, click [VIEW] ► [Guide Line]. 
Show/Hide Object ID	<ul style="list-style-type: none"> • Every object has an ID which makes the object unique.  <ul style="list-style-type: none"> • To show or hide an object's ID, click [VIEW] ► [Show/Hide Object ID]. • You can determine the type of object by its object ID. For example, an ID that begins with "SD" refers to a Word Switch.
Show/Hide Object Address	<ul style="list-style-type: none"> • To show or hide an object's address, click [VIEW] ► [Show/Hide Object Address]. If multiple addresses exist, they will be displayed together. 
Show/Hide Object Status	<ul style="list-style-type: none"> • To show or hide an object's status, click [VIEW] ► [Show/Hide Object On/Off]. • An object with a bit or word address can appear differently depending on its On/Off state or the preset condition. You can preview the states before

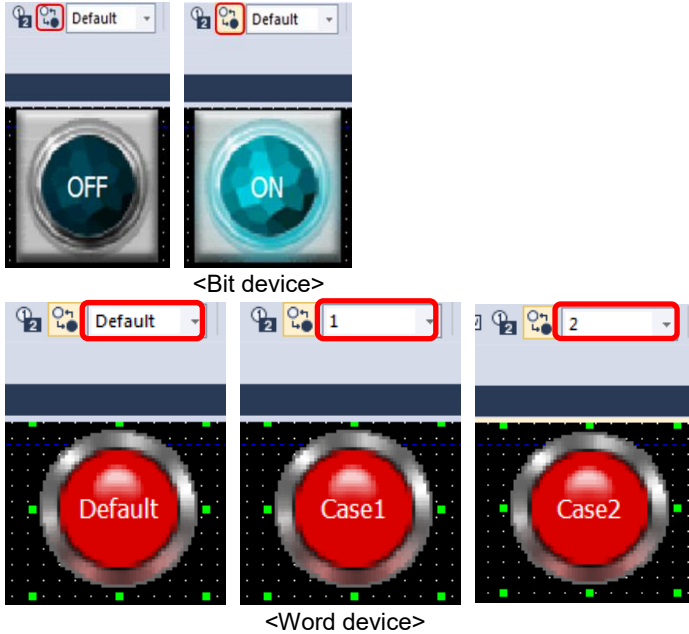
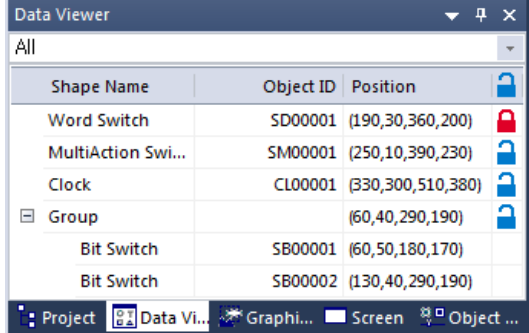
Type	Description																												
	<p>transferring the data to an XGT Panel.</p>  <p><Bit device></p> <p><Word device></p>																												
Data Viewer	<ul style="list-style-type: none"> The Data Viewer shows object type, ID, and location information, along with selection lock status. You can copy, cut, and paste items in the Data Viewer window, or enable or disable selection lock by clicking the lock icon on the right side of the object information. To open the Data Viewer, click [VIEW] ► [Data Viewer].  <table border="1" data-bbox="464 1205 995 1536"> <thead> <tr> <th>Shape Name</th> <th>Object ID</th> <th>Position</th> <th>Lock Status</th> </tr> </thead> <tbody> <tr> <td>Word Switch</td> <td>SD00001</td> <td>(190,30,360,200)</td> <td>Locked</td> </tr> <tr> <td>MultiAction Swi...</td> <td>SM00001</td> <td>(250,10,390,230)</td> <td>Unlocked</td> </tr> <tr> <td>Clock</td> <td>CL00001</td> <td>(330,300,510,380)</td> <td>Unlocked</td> </tr> <tr> <td>Group</td> <td></td> <td>(60,40,290,190)</td> <td>Unlocked</td> </tr> <tr> <td> Bit Switch</td> <td>SB00001</td> <td>(60,50,180,170)</td> <td>Unlocked</td> </tr> <tr> <td> Bit Switch</td> <td>SB00002</td> <td>(130,40,290,190)</td> <td>Unlocked</td> </tr> </tbody> </table> <ul style="list-style-type: none"> Grouped objects are shown as a “Group,” and their sizes are shown as the maximum boundaries. A dropdown filter is provided at the bottom of the Data Viewer pane to allow you to view objects by type (all, figure, or object). 	Shape Name	Object ID	Position	Lock Status	Word Switch	SD00001	(190,30,360,200)	Locked	MultiAction Swi...	SM00001	(250,10,390,230)	Unlocked	Clock	CL00001	(330,300,510,380)	Unlocked	Group		(60,40,290,190)	Unlocked	Bit Switch	SB00001	(60,50,180,170)	Unlocked	Bit Switch	SB00002	(130,40,290,190)	Unlocked
Shape Name	Object ID	Position	Lock Status																										
Word Switch	SD00001	(190,30,360,200)	Locked																										
MultiAction Swi...	SM00001	(250,10,390,230)	Unlocked																										
Clock	CL00001	(330,300,510,380)	Unlocked																										
Group		(60,40,290,190)	Unlocked																										
Bit Switch	SB00001	(60,50,180,170)	Unlocked																										
Bit Switch	SB00002	(130,40,290,190)	Unlocked																										

2.3.5.9 Registering Figures/Objects

This function saves Figure and Object settings that are used often to enable users to recreate them easily.

- 1 Open a Figure or Object.



- 2 Change the Figure or Object based on the user settings.

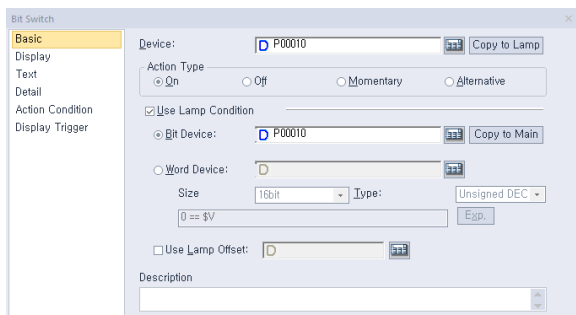

- 3 Register as a new Figure/Object.

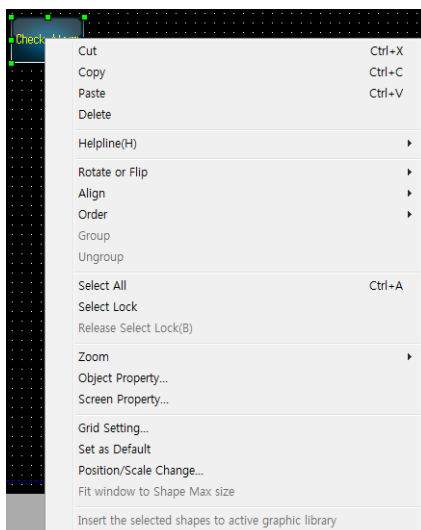

The newly made bit switch will have the same properties as the registered bit switch.

2.3.5.10 Draw from Figure to Object

This function uses the drawing sequence of “Draw from Figure to Object” to make figures consistent with the drawing sequence of the XGT panel. This enables the device and editor screens to be displayed in the same way.

- 1 Register the object on the screen.

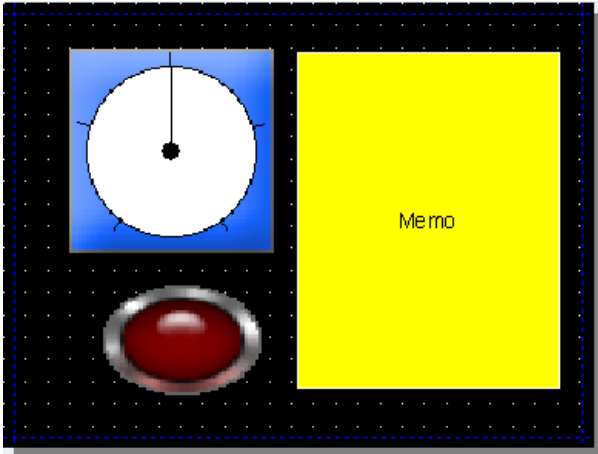

- 2 Register the figure at the top of the object.

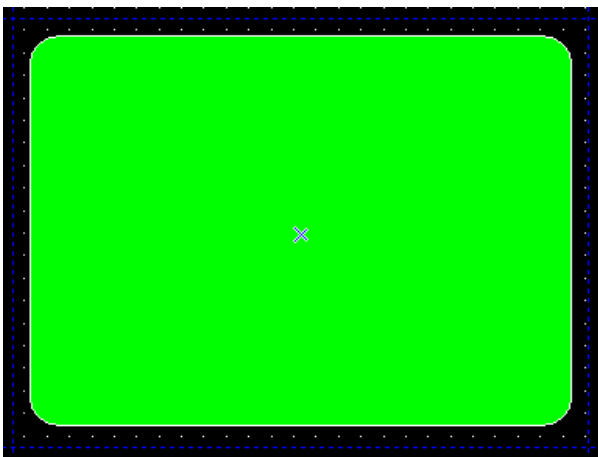

- 3 Click [VIEW] – [Draw from Figure to Object].

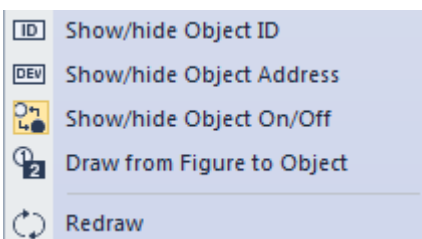

- 4 Confirm that the figure is placed below the object as shown in the following screenshot.

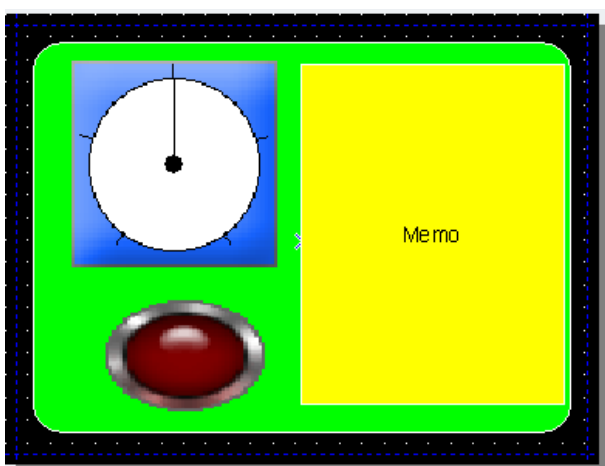

Note

- The **Draw from Shape (Figure) to Object** function enables the same drawing sequence to be used on the HMI device. It allows users to preview how the object will be displayed on the HMI device.
- When the **Draw from Figure to Object** function is used, the Selection and the Send Forward/Backward functions do not operate properly. This occurs because the order of creation and the order of display do match. To select a figure that is in the background when using this function, right-click it while pressing the Ctrl key.

2.3.5.11 Deleting an Object/Objects

To delete an object or multiple objects, click an object, or drag the pointer over multiple objects to make a selection, and then press the Delete key on the keyboard.

You can also right-click the selection, and then click [Delete].

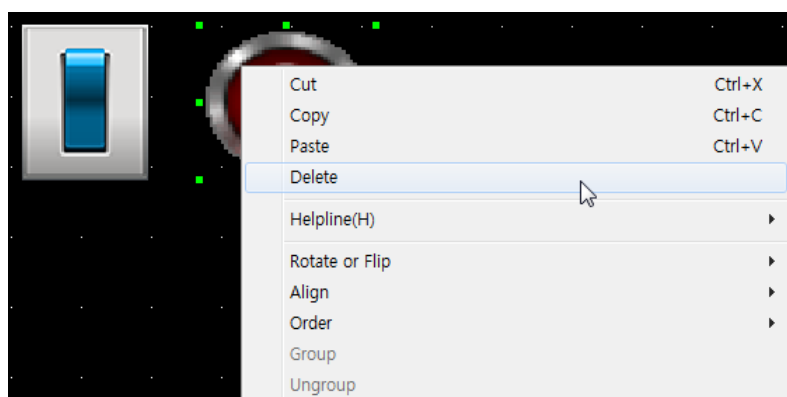

2.3.5.12 Undoing and Redoing a Change

To undo the changes, click [EDIT] ► [Undo] and select the last change made, or press CTRL+ Z.

The most recent change is canceled.

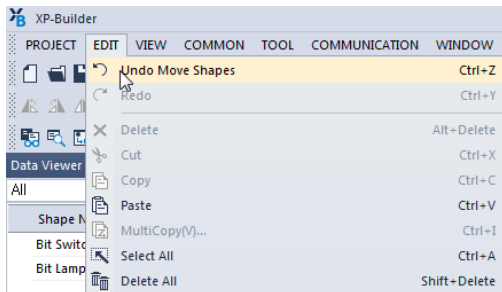

To redo the changes, click [EDIT] ► [Redo] and select the last change that has been undone, or press CTRL+ Y.

2.3.5.13 Object & Text Format

You can change the text properties of an object or several objects in a batch.

The following text formats can be changed:



Note

- In the case of 5 switches and Bit lamps, both text properties corresponding to On / Off are applied.
- For Word lamps / N-State lamps, all text properties corresponding to the number of registered status / condition statements apply.
- For Clock / History Alarm Viewer / Datalist / Logging Viewer / Datalist Editor / File Recipe Editor, it applies to the properties of the text item. However, since the object does not have [Vertical Alignment], its properties are not applied.
- The text properties set in [Conditional Statement] are not applied. It is applied to text formatting, and conditional property is not applied. For example, Numeric Display / Numeric Input only applies to the property for the text item.
- For Bit Message / Word Messages, only the size and alignment are applied. However, if [Change property selected in text table] is set, the item set in the toolbar is applied.

2.3.6 Creating Screen Tab Groups

You can split the editing area horizontally or vertically to create new tab groups. It helps you efficiently edit complicated projects composed of many screens. Group and arrange the tabs and switch between the screens that belong to the same group.

On a project with multiple screens, right-click one of the tabs and select [New Horizontal Tab group] or [New Vertical Tab group], and then add more tabs if necessary.

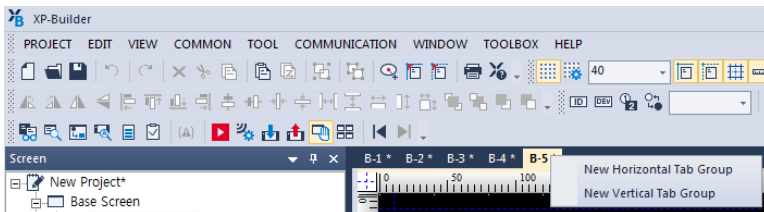

Group and arrange the tabs and switch between the screens that belong to the same group.

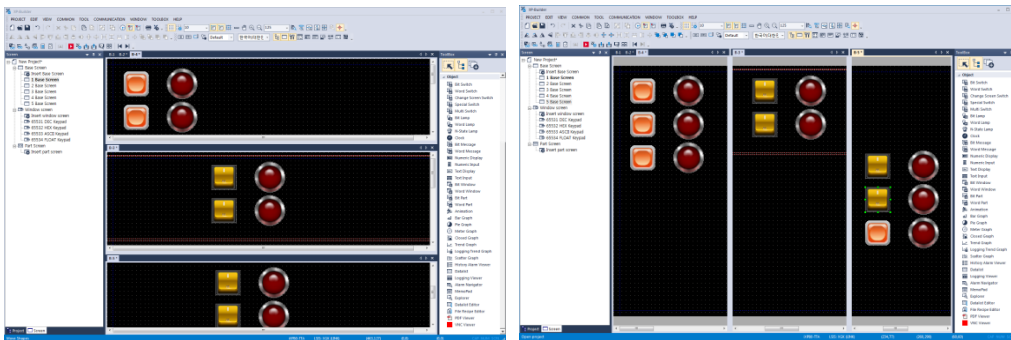

Note

- The screen tab group feature allows you to drag and drop objects. You can duplicate an object by dragging it from a screen in one tab group window and dropping it on a screen in another.
- On the newly opened windows, drag and drop the tabs into different groups, or right-click the tabs and select desired options to edit or arrange the screen for each group.

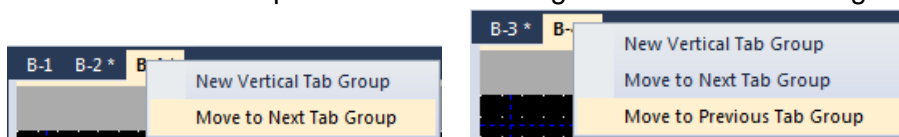

2.3.7 Exporting and Importing Fonts

When editing a project on a PC after receiving it from the XGT panel, the characters may not be displayed properly if the font used in the project is not installed on the PC. In this case, you can export the font from the project and import (install) it to the PC to solve the problem.

To export a font and install it on a PC:

- 1 Click [TOOL] ► [Export Font].

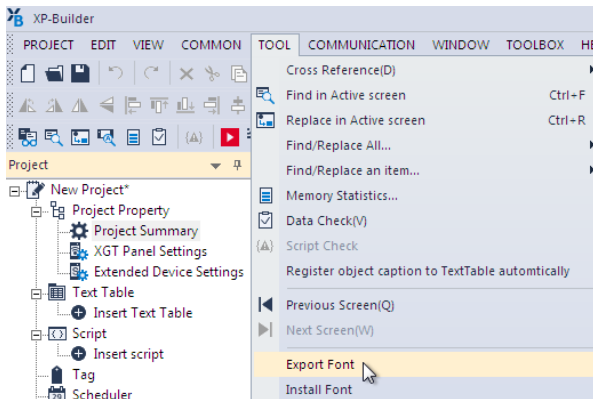

- 2 Choose the path and folder to save the font file, and then click [OK].

- 3 Click [TOOL] ► [Install Font].

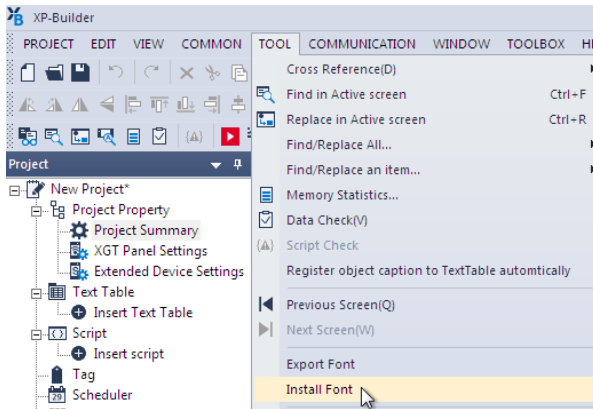

- 4 Select the folder where the font file is saved, and then click [OK].

2.3.8 Exporting and Importing Screens

The screen exporting and importing functions are used to save the current screen and the text tables, user images as well as tag elements that are related to the screen as a file or to retrieve it from another XP-Builder project on another PC.

The screen export procedure is as follows.

- 1 Select the screen(s) to export from the screen tree and click the right mouse button. Then, select [Export] from the menu.

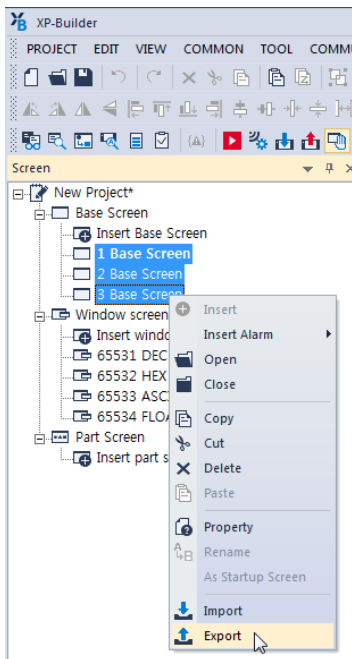

- 2 In the dialog box, select the folder to save the file in. Then, enter the file name and click [Save].
 - When the screen is exported, the following elements are also exported.

Item	Description
Screen Data	All objects and figures used on the screen
Text Tables	Text tables used by the objects on the screen
Tags	Tags used by the objects on the screen
User Images	User images used by the objects and figures on the screen

Note

The file extension for screen export files is “.xscr.”

To import a screen:

- 1 Right-click the screen you want to import from the screen tree and select [Import] from the menu.

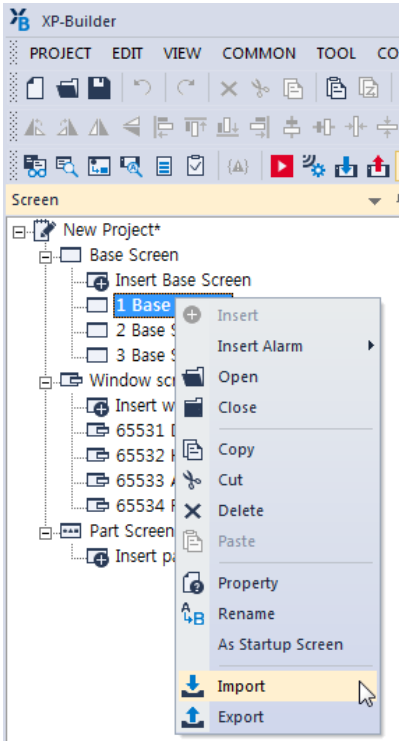

- 2 Click the file selection button at the top of the [Import] screen to select the file to import (as shown in the screenshot below).
- 3 The list of screens in the file to be imported is displayed in the preview window at the left side of the window.

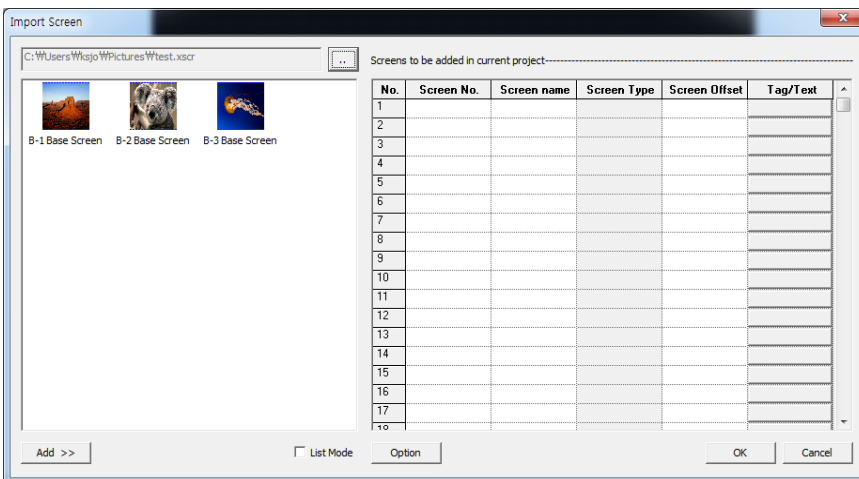

- 4 Select a screen to add from the list on the left side of the window and click [Add].
- 5 The added screen is displayed in the grid on the right side of the window as shown in the screenshot below.

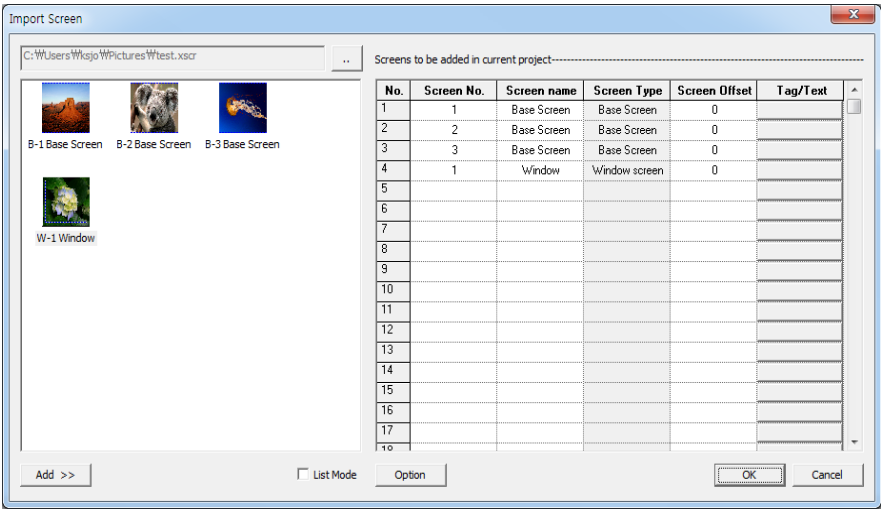

6 Change the value of the screen number, the name, the tag, and the text table as required.

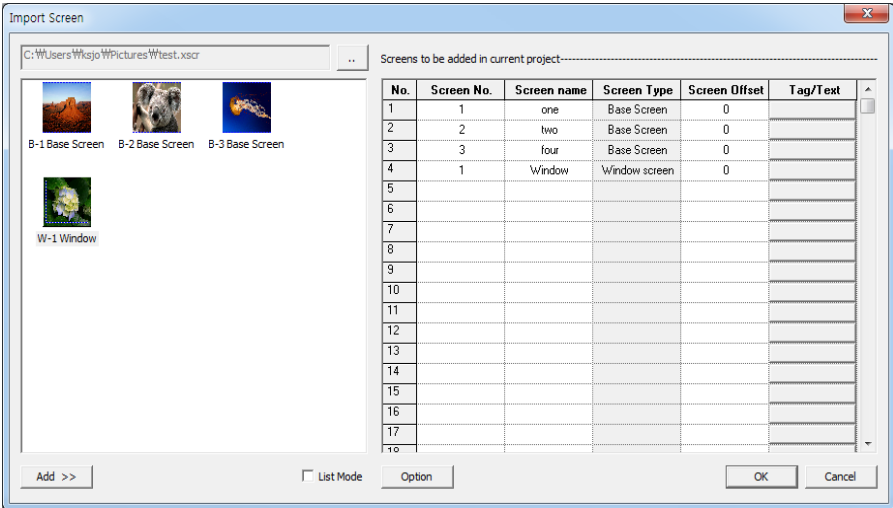

7 Click [OK] and then confirm that the selected screen and related text tables and tags are successfully added to the project.

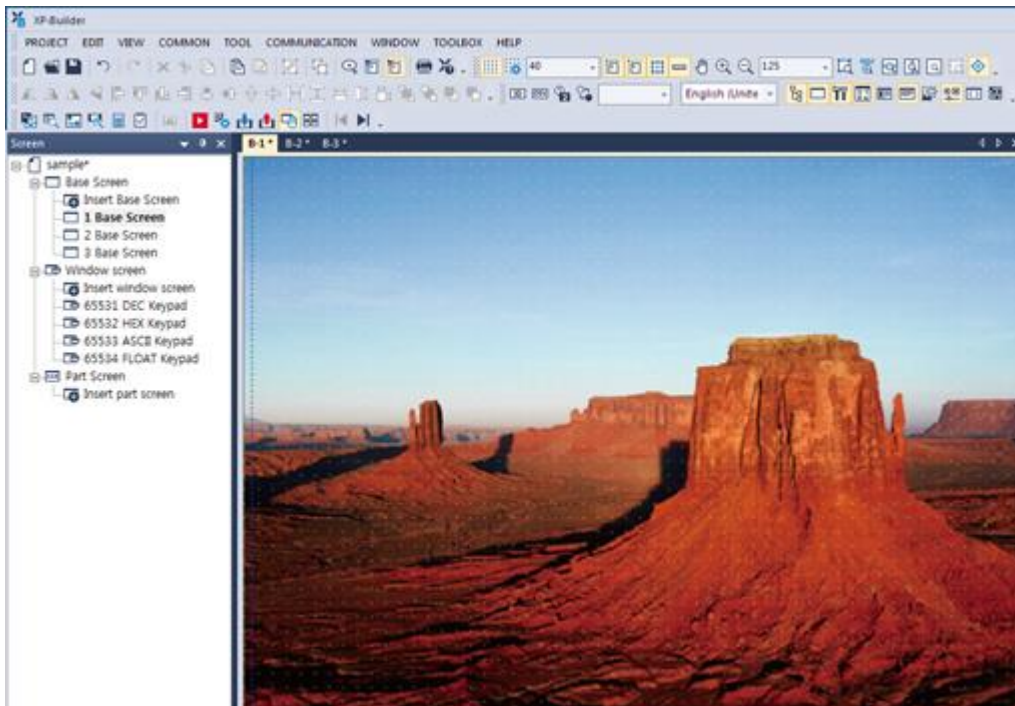

Note

- The pop-up message shown below is displayed when the same file number exists on the screen or if two or more screens have the same screen numbers in the grid.

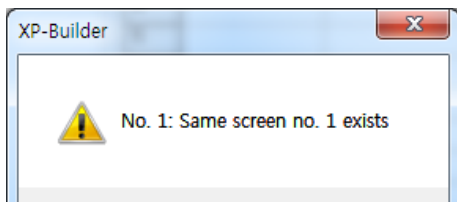

- Drag (AutoFill) the reference row from the grid to copy the screen data. The screen number increases by 1 if it is dragged down and decreases by 1 if it is dragged up based on the value of the reference row.

2.3.8.1 Import Screen Dialog Box

This section contains more information about the screen import dialog box.

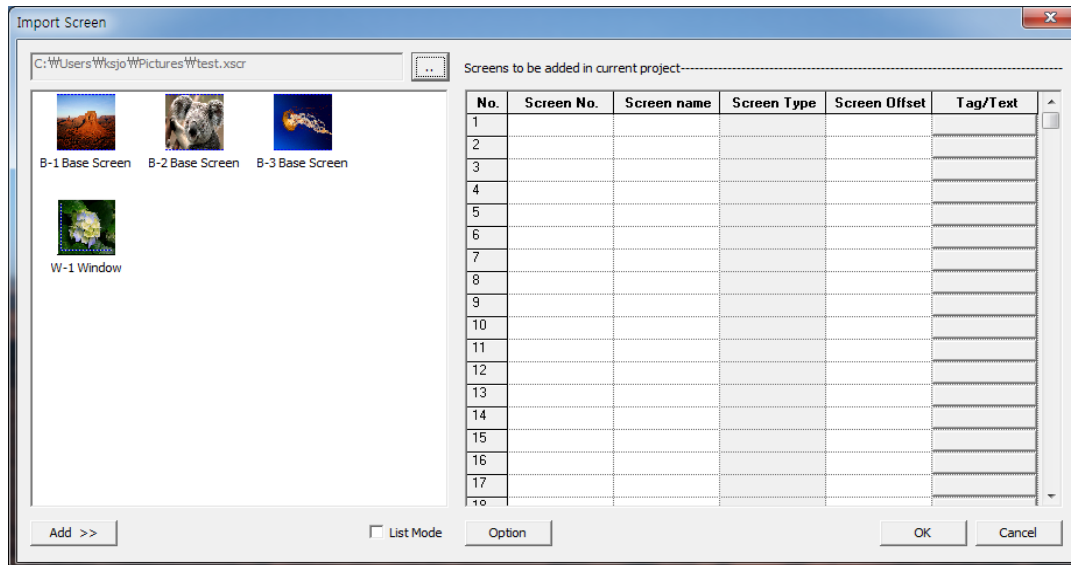

Type	Description
Select File	Select a file to import (.xscr).
Preview Screen	Display the screen list of the selected file.
Add	Select a screen to add to the project and click "Add" to add the screen data to the grid on the right side of the window.
List Mode	Displays screen data as text if list mode is checked.
Screen Number	Displays the screen number of a screen added using the [Add] button. The screen can be edited and a number from 1 to 65534 can be entered.
Screen Name	Displays the screen name of a screen added using the [Add] button. The screen name can be edited.
Screen Type	Displays the screen type of a screen added using the [Add] button. The screen type cannot be edited.
Screen Switch Offset	Change the screen number of the screen change switch when a screen is added to the project. A number from 0-65,534 can be added to the original screen number. The screen switch offset value can be edited.
OK	Add a screen to the grid in the project by clicking [OK].
Cancel	Cancel any changes to the project by clicking [Cancel].

Screen Import Option Dialog Box:

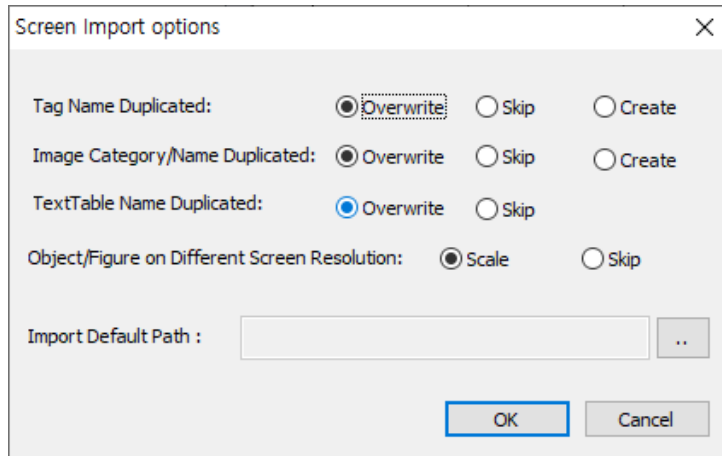

Type	Description
Tag Name Duplicated	This option is used when an existing tag in the project has the same name as a new tag to be added to the screen. There are three options available, [Overwrite], [Skip] or [Create]. The default is [Overwrite].
Image Category/Name Duplicated	This option is used when an image category or image name is duplicated in the project. There are three options available: [Overwrite], [Skip] or [Create]. The default option is [Overwrite].
Text Table Name Duplicated	This option is used when a duplicate text table name and number matches a table in the project. There are three options available: [Overwrite], [Skip] or [Create]. The default option is [Overwrite]. It is added when items used in keyword editing and character strings are changed.
Object/Figure on Different Screen Resolution	This option is used to determine if the objects and figures on the screen will be scaled to fit the current project. Alternatively, they will retain their current format to ensure the resolution of the screen to be added is different from the resolution of the project. There are two options available, [Scale] and [Skip]. The default is [Scale].
Import Default Path	Click to select the default location of imported files. <div style="border: 1px solid gray; padding: 5px; width: fit-content;"> Import Default Path : <input type="text" value="C:\Users\Public\Pictures"/> .. </div>

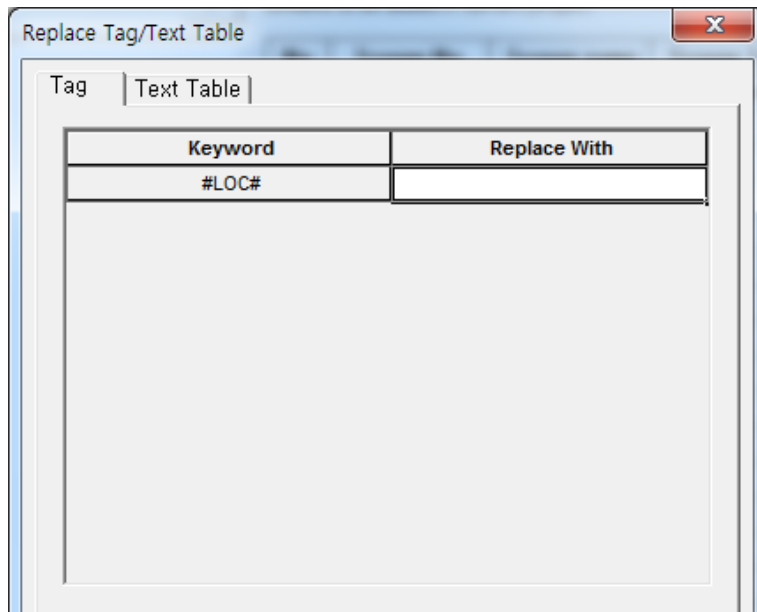
Replace Tag/Text Table Dialog Box:

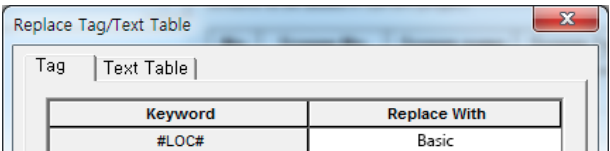
Type	Description																																																
Tag	<ul style="list-style-type: none"> This function replaces a part of a tag name with a new character string when a screen is imported. The following example shows a tag change. The replacement character string is enclosed between “#” and “#”. The objects that use the tag are registered on the screen to be exported. <p>[Setting Export Projects]</p> <table border="1"> <thead> <tr> <th>No</th> <th>Group</th> <th>Name</th> <th>Device Type</th> <th>Address</th> <th>Description</th> </tr> </thead> <tbody> <tr> <td>1</td> <td>Default</td> <td>#LOC#_tag1</td> <td>BIT</td> <td>P00000</td> <td></td> </tr> <tr> <td>2</td> <td>Default</td> <td>#LOC#_tag2</td> <td>BIT</td> <td>P00001</td> <td></td> </tr> <tr> <td>3</td> <td>Default</td> <td>#LOC#_tag3</td> <td>BIT</td> <td>P00002</td> <td></td> </tr> </tbody> </table> <ul style="list-style-type: none"> If “Basic” is entered as the replacement character string, the tag names will be changed as shown below. It shows that “#LOC#” is replaced by “Basic”. If the same group name and number exist on the screen, a new tag is created and added.  <p>[Import Results]</p> <table border="1"> <thead> <tr> <th>No</th> <th>Group</th> <th>Name</th> <th>Device Type</th> <th>Address</th> <th>Description</th> </tr> </thead> <tbody> <tr> <td>1</td> <td>Default</td> <td>Basic_tag1</td> <td>BIT</td> <td>P00000</td> <td></td> </tr> <tr> <td>2</td> <td>Default</td> <td>Basic_tag2</td> <td>BIT</td> <td>P00001</td> <td></td> </tr> <tr> <td>3</td> <td>Default</td> <td>Basic_tag3</td> <td>BIT</td> <td>P00002</td> <td></td> </tr> </tbody> </table>	No	Group	Name	Device Type	Address	Description	1	Default	#LOC#_tag1	BIT	P00000		2	Default	#LOC#_tag2	BIT	P00001		3	Default	#LOC#_tag3	BIT	P00002		No	Group	Name	Device Type	Address	Description	1	Default	Basic_tag1	BIT	P00000		2	Default	Basic_tag2	BIT	P00001		3	Default	Basic_tag3	BIT	P00002	
No	Group	Name	Device Type	Address	Description																																												
1	Default	#LOC#_tag1	BIT	P00000																																													
2	Default	#LOC#_tag2	BIT	P00001																																													
3	Default	#LOC#_tag3	BIT	P00002																																													
No	Group	Name	Device Type	Address	Description																																												
1	Default	Basic_tag1	BIT	P00000																																													
2	Default	Basic_tag2	BIT	P00001																																													
3	Default	Basic_tag3	BIT	P00002																																													
Text Table	<ul style="list-style-type: none"> This function replaces a part of the character strings in the text table with a new character string when a screen is imported. The following example shows the process of changing a text table. The replacement character string is enclosed between “#” and “#”. The objects using the text table are registered on the screen to be exported. 																																																

Type	Description																																																																										
	<p>[Setting Export Projects]</p> <table border="1"> <thead> <tr> <th colspan="7">B-1 Text Table_01 *</th> </tr> <tr> <th>No</th> <th>English (United States)</th> <th>Color</th> <th>Italic</th> <th>Underline</th> <th>StrikeOut</th> <th>Bold</th> </tr> </thead> <tbody> <tr> <td>0</td> <td>text=#NO#_first</td> <td style="background-color: black;"></td> <td>Off</td> <td>Off</td> <td>Off</td> <td>Off</td> </tr> <tr> <td>1</td> <td>text=#NO#_second</td> <td style="background-color: black;"></td> <td>Off</td> <td>Off</td> <td>Off</td> <td>Off</td> </tr> <tr> <td>2</td> <td>text=#NO#_third</td> <td style="background-color: black;"></td> <td>Off</td> <td>Off</td> <td>Off</td> <td>Off</td> </tr> </tbody> </table> <ul style="list-style-type: none"> If "01" is entered as the replacement character string, the tag names will be changed as shown below. It shows that "#NO#" is replaced with "01". If the same text table name and number exists, a new text table item is created and added. <div style="border: 1px solid gray; padding: 5px; margin: 10px 0;"> <p>Replace Tag/Text Table</p> <p>Tag: Text Table</p> <table border="1" style="width: 100%;"> <thead> <tr> <th>Keyword</th> <th>Replace With</th> </tr> </thead> <tbody> <tr> <td>#NO#</td> <td>01</td> </tr> </tbody> </table> </div> <p>[Import Results]</p> <table border="1"> <thead> <tr> <th colspan="7">B-1 Text Table_01 *</th> </tr> <tr> <th>No</th> <th>English (United States)</th> <th>Color</th> <th>Italic</th> <th>Underline</th> <th>StrikeOut</th> <th>Bold</th> </tr> </thead> <tbody> <tr> <td>0</td> <td>text_01_first</td> <td style="background-color: black;"></td> <td>Off</td> <td>Off</td> <td>Off</td> <td>Off</td> </tr> <tr> <td>1</td> <td>text_01_second</td> <td style="background-color: black;"></td> <td>Off</td> <td>Off</td> <td>Off</td> <td>Off</td> </tr> <tr> <td>2</td> <td>text_01_third</td> <td style="background-color: black;"></td> <td>Off</td> <td>Off</td> <td>Off</td> <td>Off</td> </tr> </tbody> </table>	B-1 Text Table_01 *							No	English (United States)	Color	Italic	Underline	StrikeOut	Bold	0	text=#NO#_first		Off	Off	Off	Off	1	text=#NO#_second		Off	Off	Off	Off	2	text=#NO#_third		Off	Off	Off	Off	Keyword	Replace With	#NO#	01	B-1 Text Table_01 *							No	English (United States)	Color	Italic	Underline	StrikeOut	Bold	0	text_01_first		Off	Off	Off	Off	1	text_01_second		Off	Off	Off	Off	2	text_01_third		Off	Off	Off	Off
B-1 Text Table_01 *																																																																											
No	English (United States)	Color	Italic	Underline	StrikeOut	Bold																																																																					
0	text=#NO#_first		Off	Off	Off	Off																																																																					
1	text=#NO#_second		Off	Off	Off	Off																																																																					
2	text=#NO#_third		Off	Off	Off	Off																																																																					
Keyword	Replace With																																																																										
#NO#	01																																																																										
B-1 Text Table_01 *																																																																											
No	English (United States)	Color	Italic	Underline	StrikeOut	Bold																																																																					
0	text_01_first		Off	Off	Off	Off																																																																					
1	text_01_second		Off	Off	Off	Off																																																																					
2	text_01_third		Off	Off	Off	Off																																																																					

2.3.9 Printing a Project

You can save detailed project information in an MS Excel file format for documentation and reviewing.

To save the project information in an MS Excel file:

- 1 Click [PROJECT] ► [Project Print].

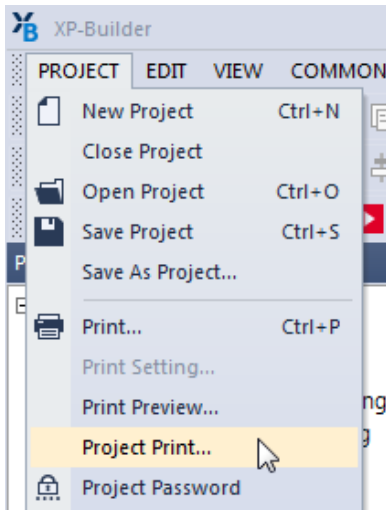

- 2 In the **Content** tab, select the items to include.

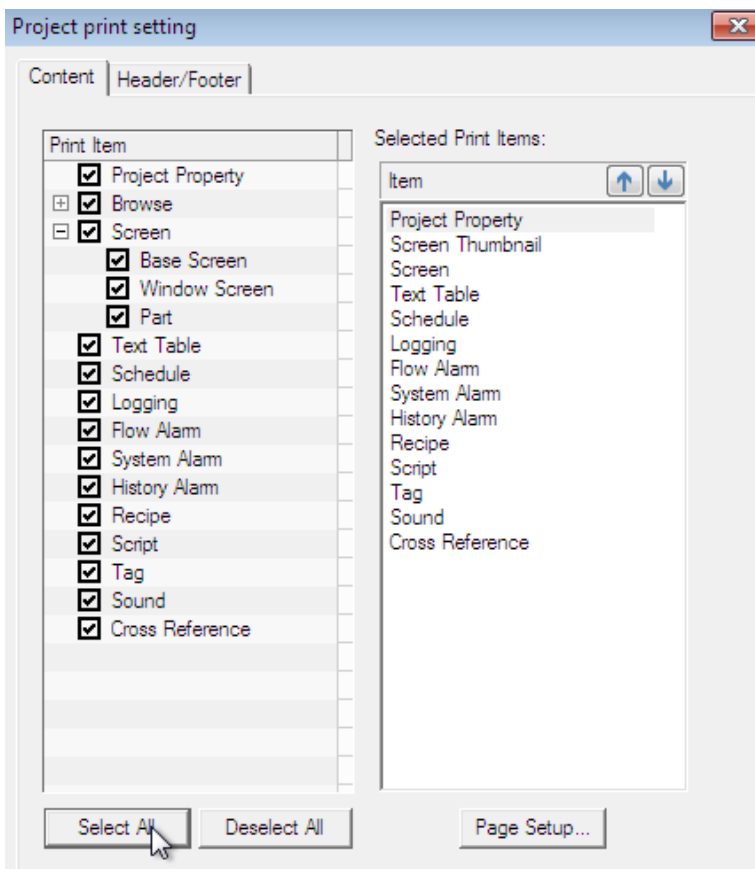

Note

- In the Selected Print Items pane, you can rearrange the order of each selected item.
- It is saved in Excel format even if Excel is no installed.
- If Excel is installed, check the Open in Excel item to automatically open the Excel format document.
- In an environment where Excel is not installed, a folder containing Excel format documents will be opened.

3 In the **Header/Footer** tab, specify options for a header or footer, and then click [OK].

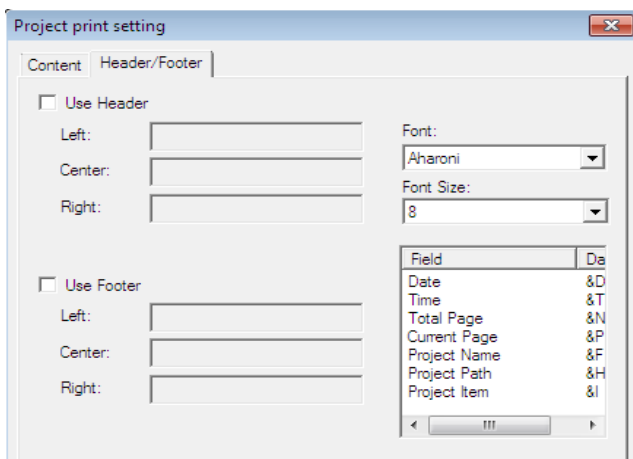

- An MS Excel file including the selected project data opens on the computer screen automatically.

[Project Property]		
Project Name:	new	
Location:	D:\XPBUILDER\new.xpd	
Author:	user	
Version:	2	
HMI Model:	ixp50-TTA	
Connected Controller:		
Manufacturer	Company Name	Protocol
LSIS: X8K (LINK)	LSIS	RS232C
-	-	-
-	-	-
-	-	-
[Screen Change Setting]		
Start Screen:	1	
Screen Change Device Address:		
Base Screen	Screen No.	
Global Window1	-	
Global Window2	-	
[Key Window Setting]		
KeyPad Type	Screen No.	
DEC Keypad	65631	
HEX Keypad	65632	
ASCII Keypad	65633	
Float Keypad	65634	
[Storage Option]		
Save Items	Media	Path
Image	Local Memory	Image
Font	Local Memory	Font
Logging	Do not use	Logging
Recipe	Do not use	Recipe
Screen Capture	Do not use	ScreenCapture
[Language Setting]		

2.3.10 Renaming a Tag to add as a New Tag

You can rename a tag that is already on the screen and add it as a new tag.

To rename a tag and add it as a new tag:

- 1 Place an object, register a tag with a name ('TagOld'), and assign it to a device in the object.

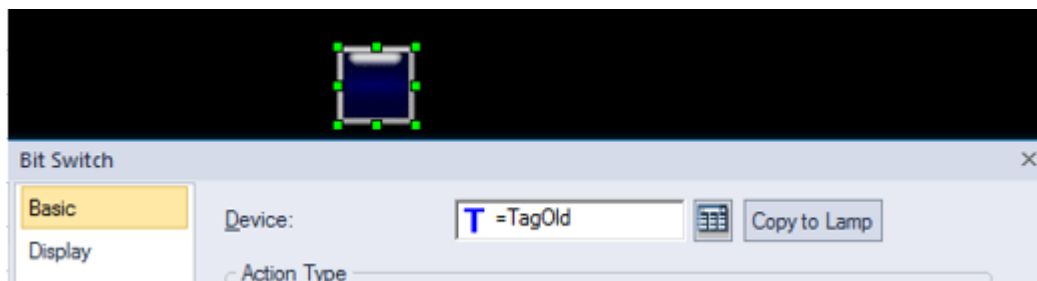

- 2 Click [TOOL] ► [Replace Tag Name and Register as a New Tag].

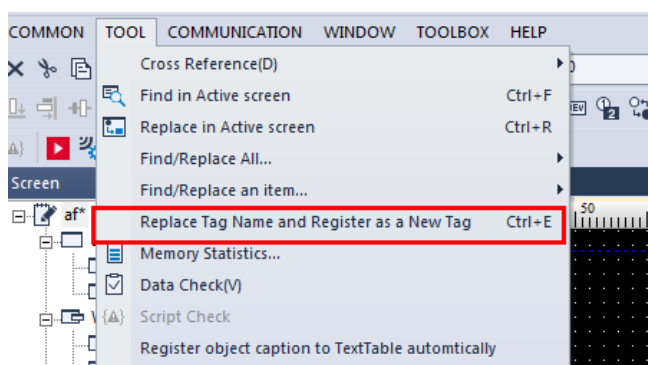

- 3 In the pop-up window, enter the tag name to search and a new name to replace it.

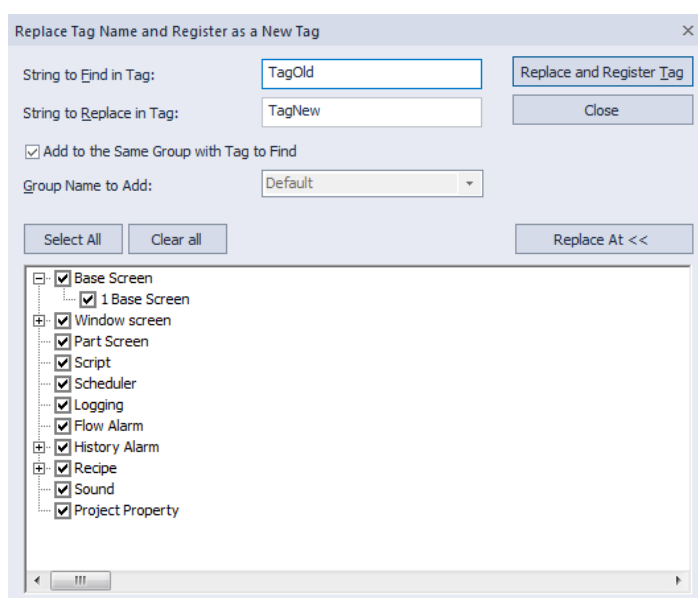

Note

- By default, the newly registered tag is added to the same tag group as the one the original tag belongs to. You can select a different tag group, or create a new tag group and select it.
- By default, the tag replacement range is set as the entire project. You can click “Replace At” to specify the range.
- The new tag name must be in a valid format. The following message will be displayed if the tag name is missing, if the first character is a number, or if the tag name contains control characters or device addresses.

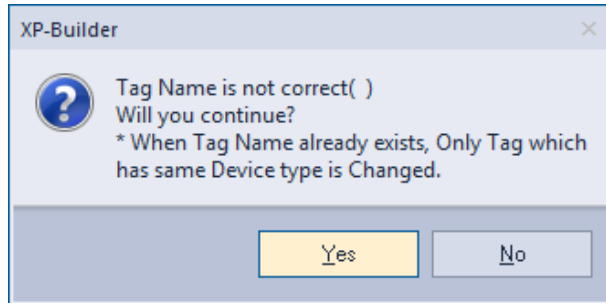

- If the tag name already exists, the following message will be displayed. You can click [Yes] to replace the existing tag, or [No] to cancel. Note that the tag will not be replaced even if you click [Yes] if the device types are different for the new and existing tags.

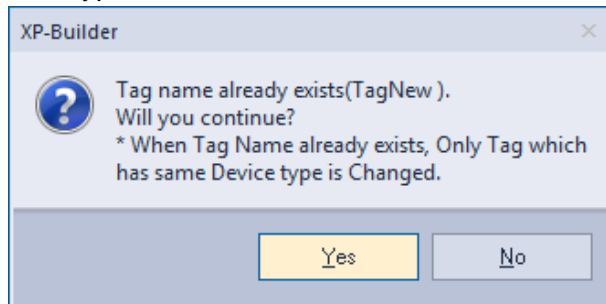

4 Click [Yes]. The new tag name ('TagNew') is listed in the properties window, and the object's tag name has been changed to 'TagNew.'

ID	Group	Name	Device Type	Address
1	Default	TagOld	BIT	HX00050
2	Default	TagNew	BIT	HX00060
3	Default			

2.3.11 Setting HW Key for Handy on Screen

The handy model HMI (example: iXP2H) provides an object for connecting to the operation of an external mounted button or lamp and an external object setting window docked on the screen. The following describes how to set up an external object that works only on the screen. Refer to **<2.2.2.10 Changing Extended Device Settings>** in the project properties for setting the globally operating external object.

Setting an external object to work on the screen:

- 1 [Base Screen] ► Double-click [Insert Base Screen]

If the external object docking window appears on the right side of the screen, click on the title and the following setting window appears.

Then click the Auto hide button to hide the setting window on the right of the screen..

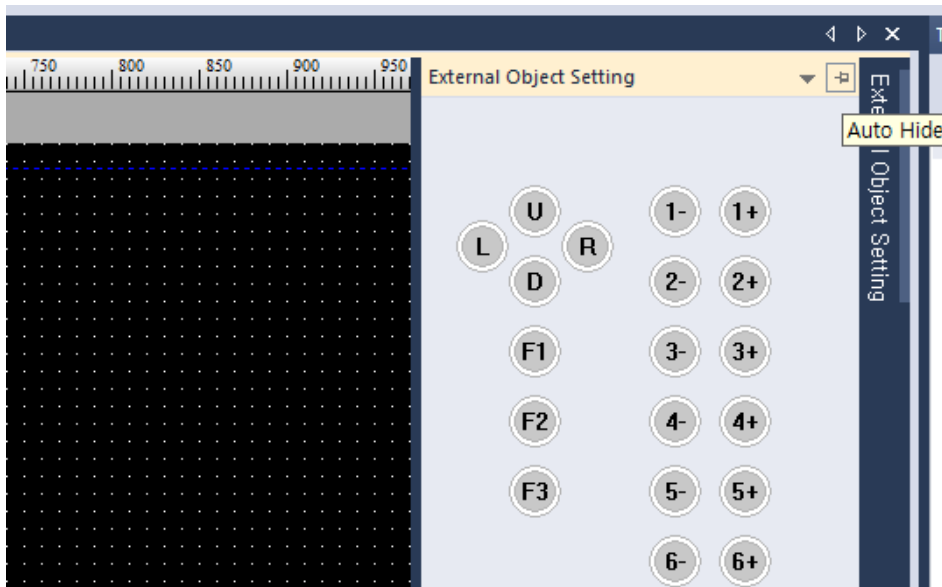

- 2 Double-click the circular button on the docking window to add an external object.

You can only add external multiple switches within the screen, but you can also add external lamps in the global window. For detailed object attributes and settings, refer to the corresponding object description.

2. Project Development

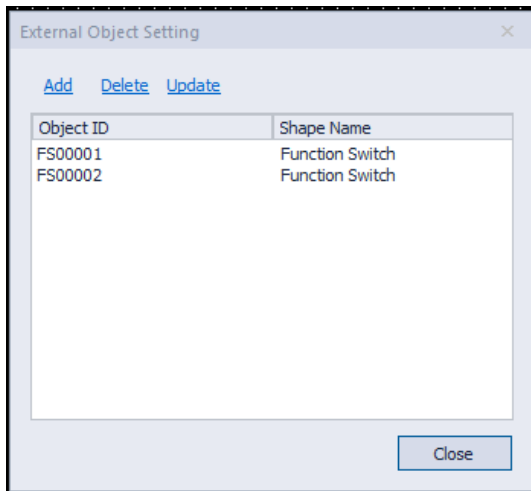

3 After adding an object to the Data Viewer window it is shown as follows:

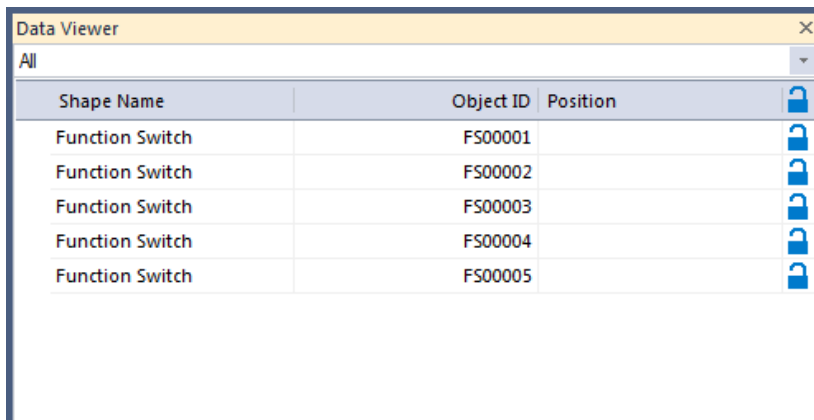

4 Select the object to delete from the external object setting window and click Delete button to delete the object.

The object can be deleted from the Data Viewer window can be deleted using the same method.

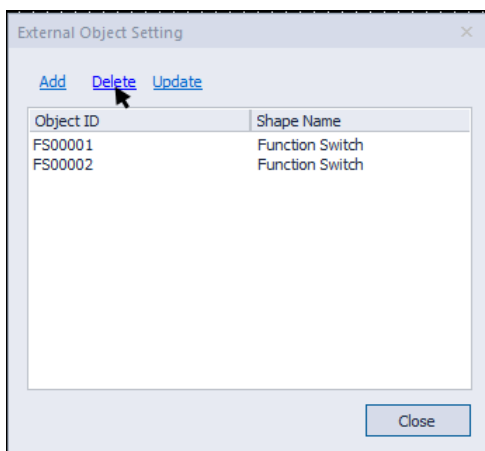

- 5** In the External Object Settings window, select the object to change and then click or double-click Change.

If the object's attribute box appears, change the properties and click OK.

You can change the properties in the Data Viewer window in the same way as before.

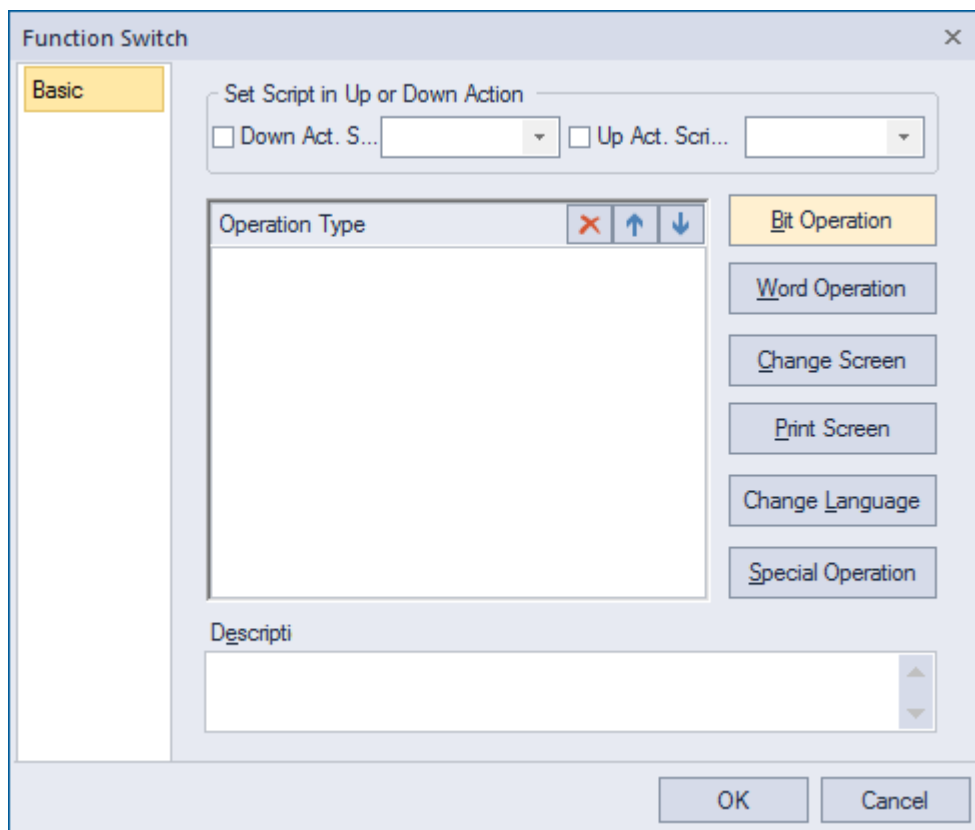

Note

- The real object that is edited is not shown on the actual screen so there may be some discrepancy in the changes.

The following operations cannot be edited:.

Move / resize / drag / drop, change position and size, copy / cut / paste to same size / screen centering / spacing equally

2.3.12 Print

This feature allows you to print the contents of the screen.

- 1 [Project] ► click [Print]

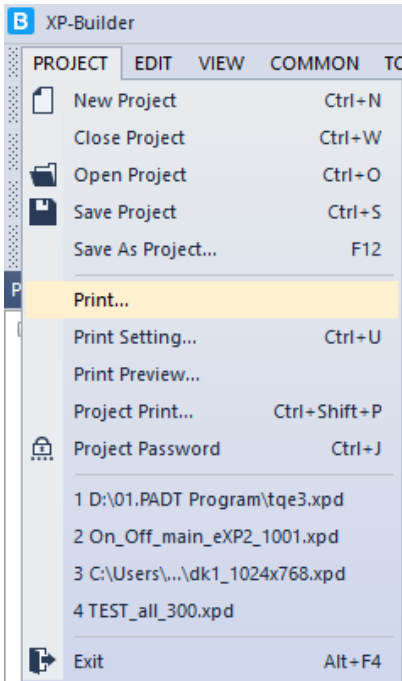

- 2 After selecting the print on the print screen, select [OK]

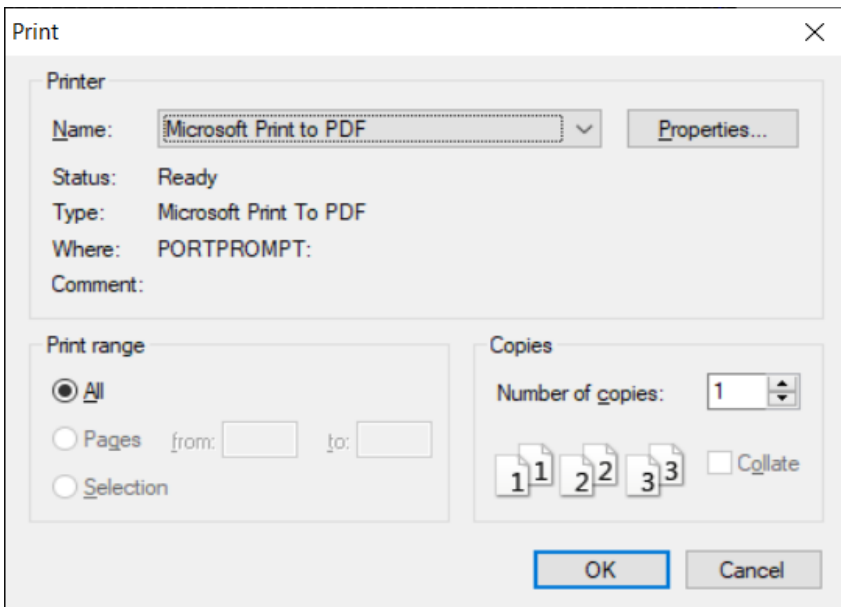

- 3 The figure below is the result of printing by selecting the [Microsoft Print to PDF] option. The base screen, window screen, part screen, and HDMI screen created in project are all output. If the size of the screen is larger than the print paper size, the output is adjusted to fit the paper size.

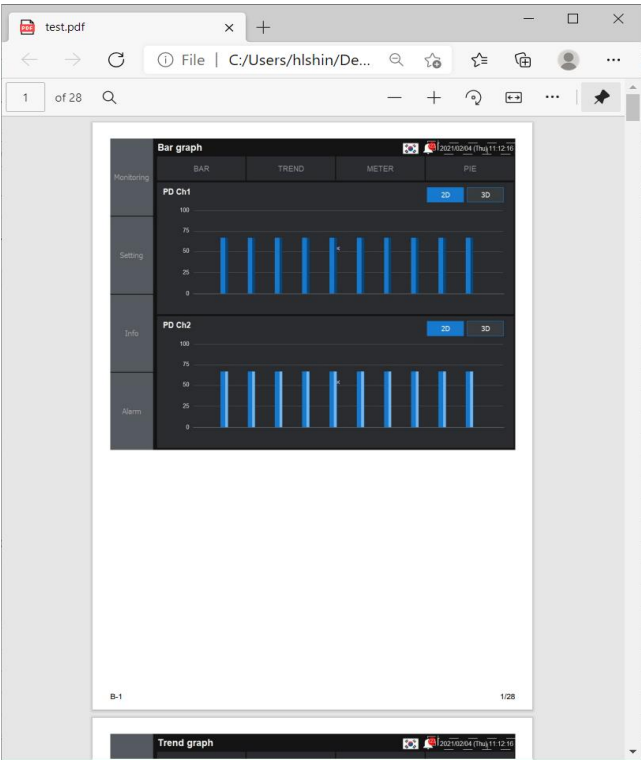

4 If the orientation is set to landscape on the print screen, it will be printed in landscape format.

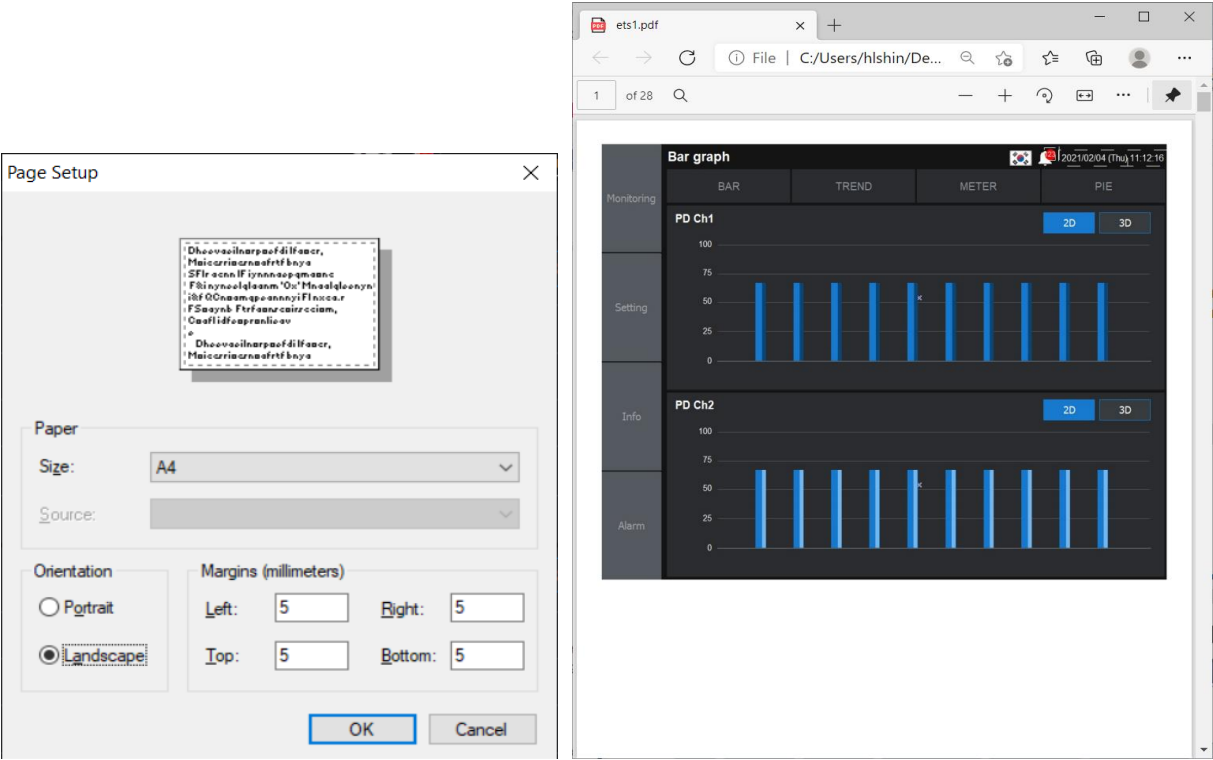

2.3.13 *Print Preview*

This feature allows you to preview the printed screen contents.

- 1 [Project] ► click [Print Preview]

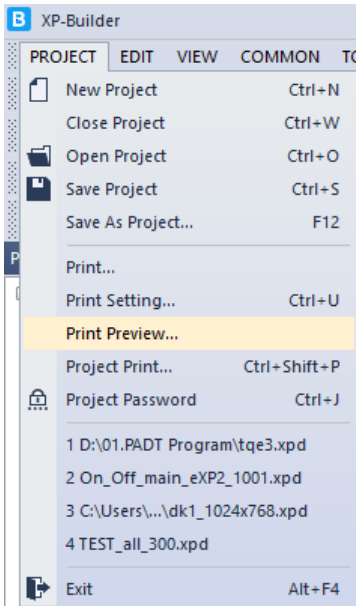

- 2 The screen print preview screen is displayed. The base screen, window screen, part screen, and HDMI screen created in the project are all displayed. If the screen size is larger than the print paper size, it is adjusted to fit the paper size and displayed.

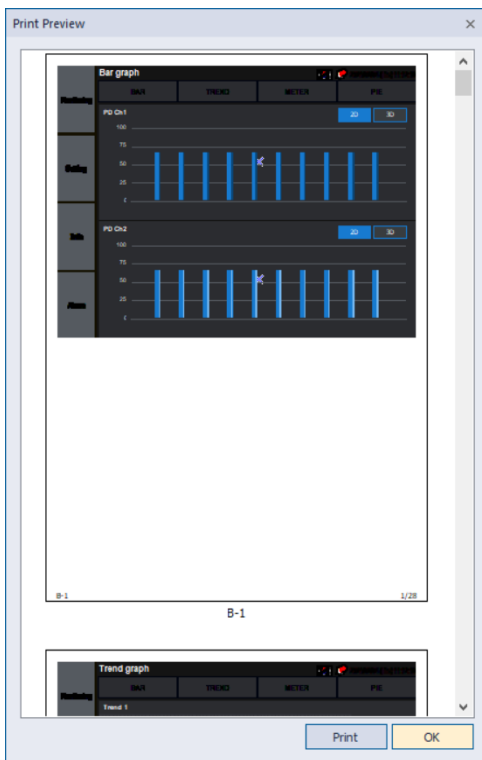

3 If the orientation is set to landscape in [Print Setting], the preview screen is displayed in horizontal format.

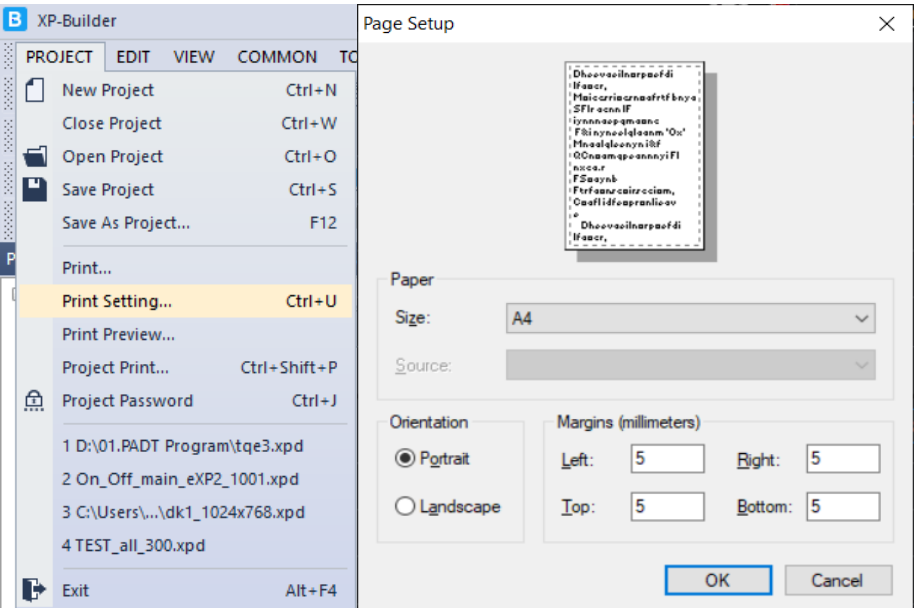

4 If you select the [Print] button, the screen will be printed to the set print in the same way as the [Print] function.

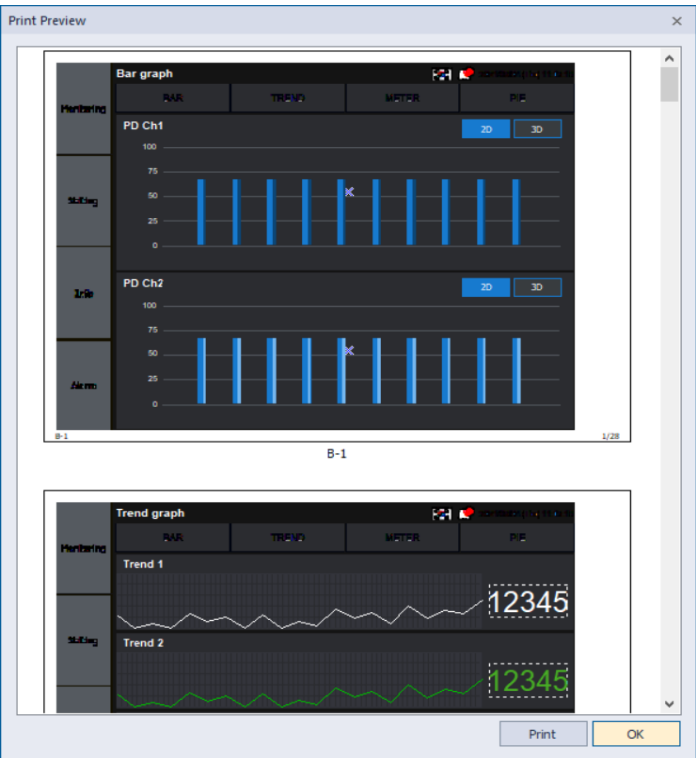

2.4 Managing Libraries

2.4.1 Managing Graphic Libraries

Learn how to manage image libraries. Both the system and user image libraries can be managed, but only the user image library can be edited.

Type	Description						
System Graphic Library	<p>About 8,000 images in 40 categories are included in the System Graphic Library. This library cannot be edited. You can select raster (256-color) or vector (65,535-color) images, depending on the color capabilities of the XGT Panels you are using. The following table describes characteristics of raster and vector images.</p> <table border="1"> <thead> <tr> <th>Type</th> <th>Description</th> </tr> </thead> <tbody> <tr> <td>Raster</td> <td> <p>Displayed in pixels as a bitmap image. Distorts when you zoom in or out. If used as a background image in an object, the pattern and color cannot be changed.</p> </td> </tr> <tr> <td>Vector</td> <td> <p>Expressed by connected lines. Not distorted when you zoom in or out. Not recommended to use a vector image as a background image of an object. Excessive use of vector images slows down the panel operation speed.</p> </td> </tr> </tbody> </table>	Type	Description	Raster	<p>Displayed in pixels as a bitmap image. Distorts when you zoom in or out. If used as a background image in an object, the pattern and color cannot be changed.</p>	Vector	<p>Expressed by connected lines. Not distorted when you zoom in or out. Not recommended to use a vector image as a background image of an object. Excessive use of vector images slows down the panel operation speed.</p>
Type	Description						
Raster	<p>Displayed in pixels as a bitmap image. Distorts when you zoom in or out. If used as a background image in an object, the pattern and color cannot be changed.</p>						
Vector	<p>Expressed by connected lines. Not distorted when you zoom in or out. Not recommended to use a vector image as a background image of an object. Excessive use of vector images slows down the panel operation speed.</p>						
User Graphic Library	<p>You can register, modify or delete images. The images are saved in the current project and not in the XP-Builder program. You can import a User Graphic Library from another project or export it from the current project to use in other projects.</p>						

To open the Graphic Library pane, click [VIEW] ► [Graphic Library]. The Graphic Library pane will appear, as shown in the following image:

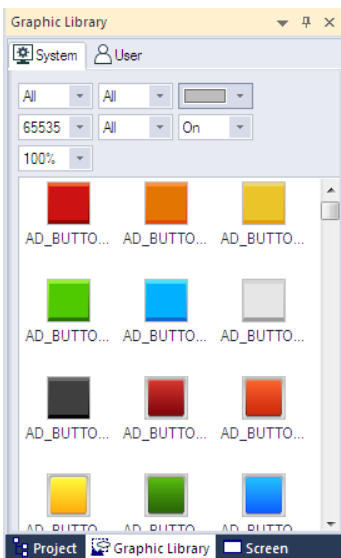

In the Graphic Library pane, you can drag and drop an image into the editing area.

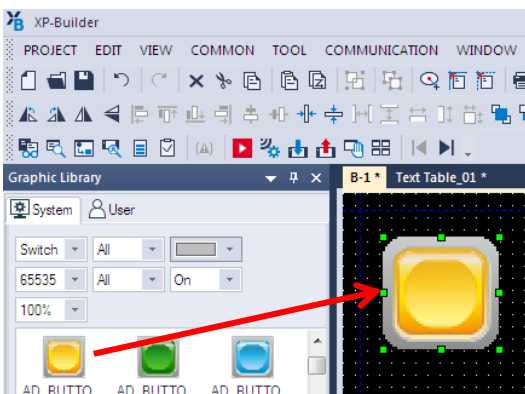

Note

- A tooltip (max 320 x 320 px.) is displayed to show the enlarged image, along with its full name, file size, and image size, when you move the mouse pointer over the images in the library.

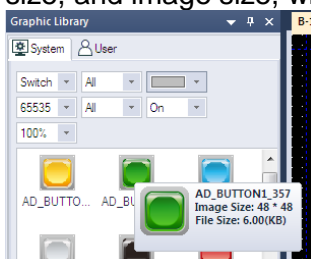

- Dropdown filters are provided at the top of the Graphic Library pane to allow you to easily find the specific images that you are looking for. You can set the image category and sub-category, image color, image type (vector or raster), colors (All, 256, 65536), and on/off status of the image for viewing.

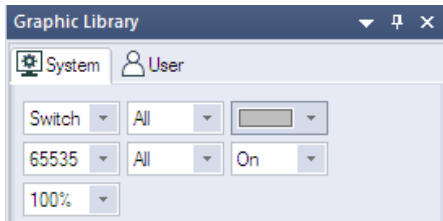

- You can also zoom in or out of images by selecting one of the magnification presets in the dropdown list.
- Vector images maintain their shape even if you change their size. Raster images may be distorted if you enlarge or reduce their size.
- When you drag an image to the editing area, it is created in its default size. The default sizes of images are variable.

2.4.1.1 Creating a User Graphic Library

You can create your own user image library.

To create a library:

- 1 In the Graphic Library pane, click the **User** tab.

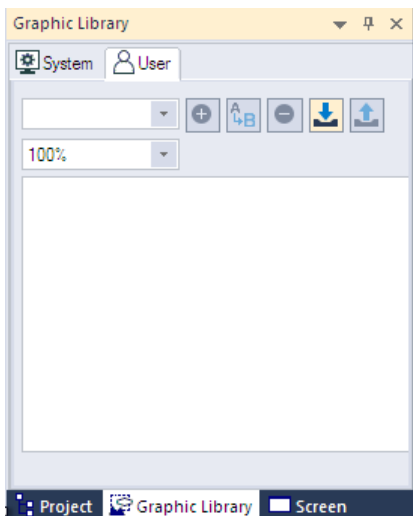

- 2 Enter the name of the library and click . A new image category will be created.

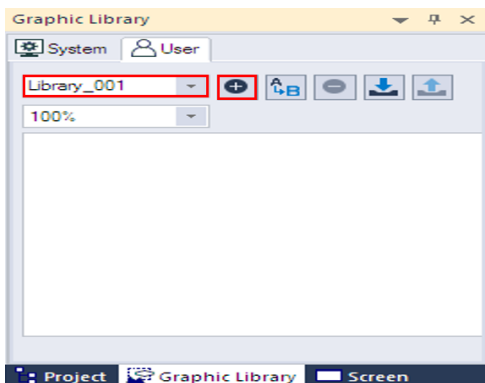

- 3 Right-click an empty area in the Graphic Library pane, and then select [Insert Image].

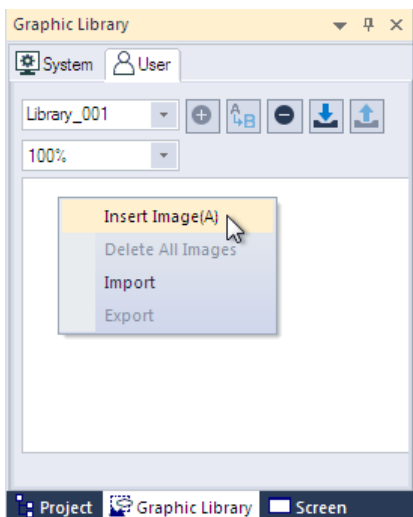

- 4 Select the image files in the browsing window, and then click [Open].

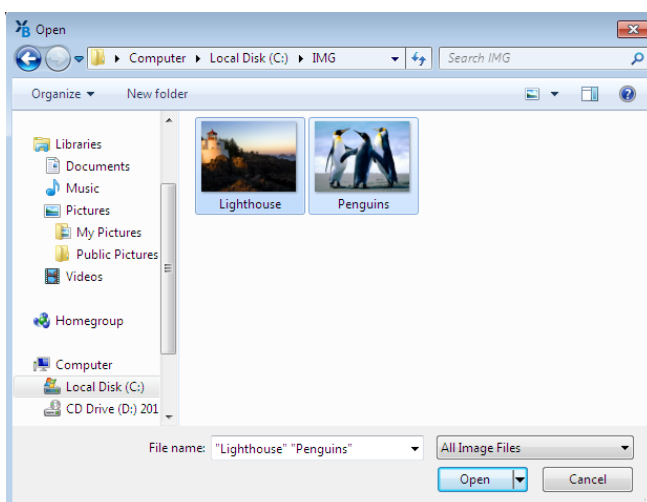

- Images have been added to the new graphic library.

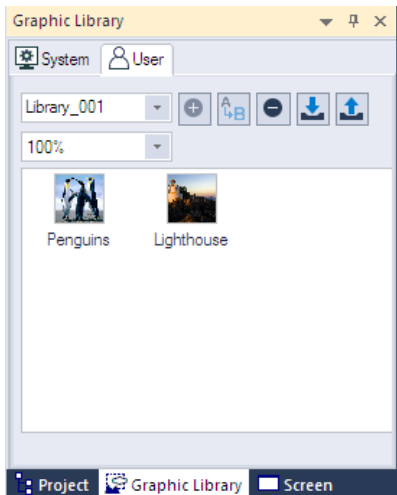

Note

- You can also drag the image from the browsing window and drop it to the User Graphic Library pane.
- To delete an image, right-click an image and then click [Delete Image].

Note

- The WMF format is used only in XP-Builder. You can draw figures in XP-Builder and directly add it to a user graphic library in WMF image format. WMF images are not distorted when you resize them.

To add WMF (vector) figures to a library:

1. In the editing area, right-click a figure to save it.
2. Click [Insert the selected shapes to active graphic library].

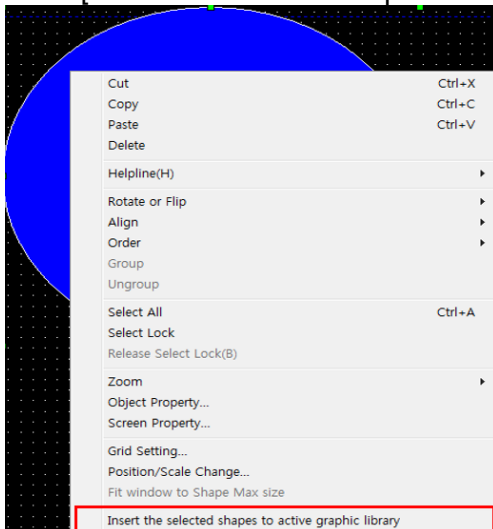

The image is added to the library in WMF format.

- Figures filled with patterns #3-41 and figures with textures cannot be inserted to a user graphic library in WMF format.
- You cannot save WMF images as image files.

2.4.1.2 Exporting a User Graphic Library

You can share libraries between projects.

To export your user object library after creating it:

- 1 In the Graphic Library pane, click the User tab.
- 2 Select a library to export from the drop-down list and click  or right-click an empty area in the Graphic Library pane and click [Export].

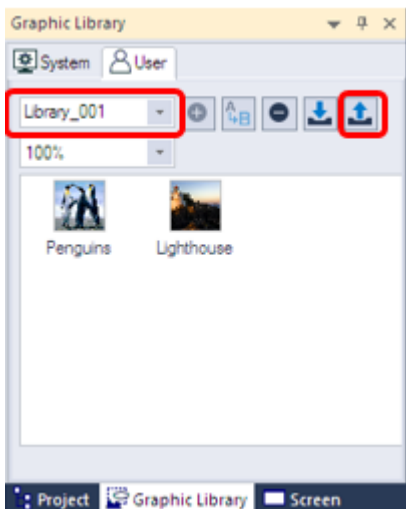

- 3 Enter a name for the file and set the file destination.
- 4 Click [Save].

Note

- The exported library is saved as an .xpg file.
- If there are no images in the library, you cannot export the graphic library.

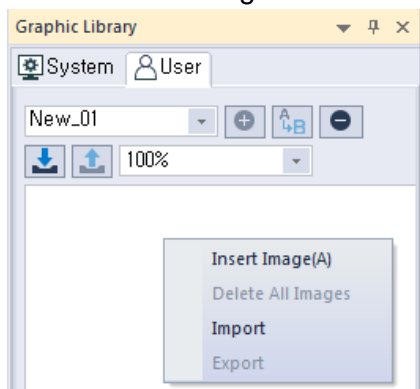

2.4.1.3 Importing a User Graphic Library

You can either import a library into the project as a new library or you can import images into an existing user graphic library.

To import a new library:

- 1 In the Graphic Library pane, click the **User** tab.
- 2 Click .

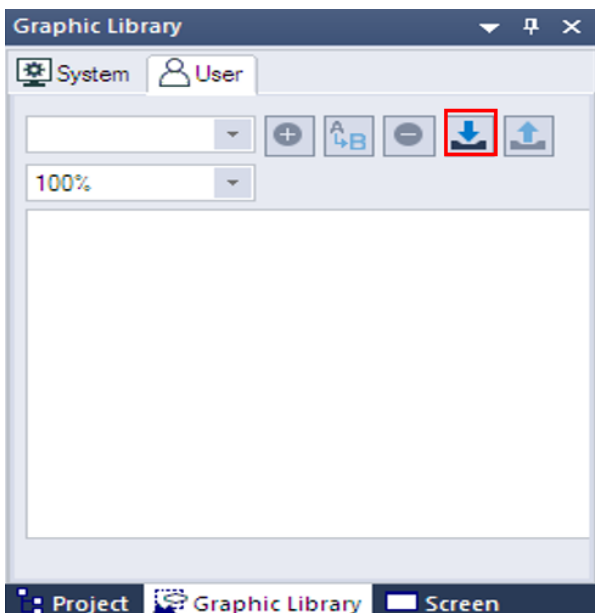

- 3 Select an .xpg file and click [Open]. You can also select multiple files to add.

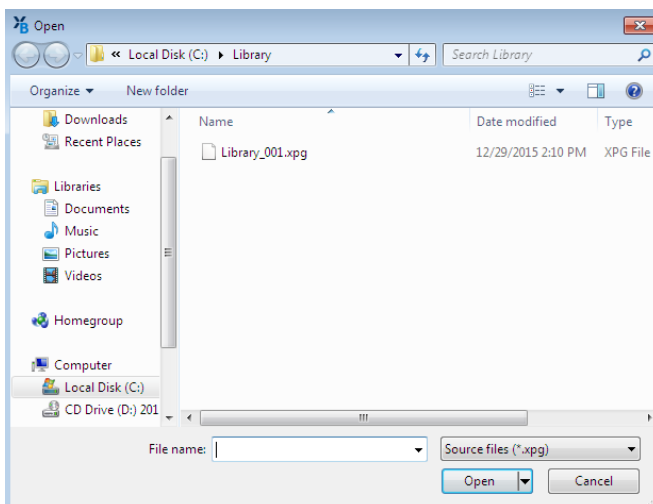

- The new library will be added to the Graphic Library List.

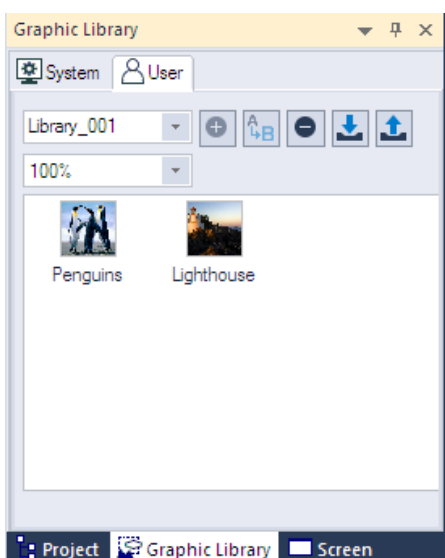

To import images into an existing user library:

- 1 In the Graphic Library pane, click a user graphic library name.
- 2 In the Graphic Library pane, right-click an empty area, and then click [Insert Image].

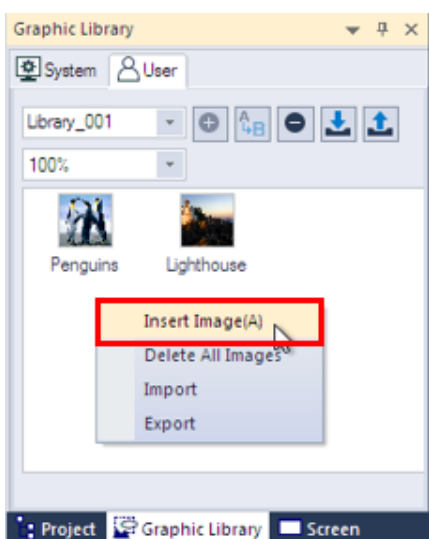

- 3 Select image files and click [Open]. The selected images will be added to your user library.

Note

If an image file with the same name exists in the graphic library, a pop-up window is displayed to ask you for a new file name. Enter a new name and click [OK] to proceed.

Enter new name

Same image name exists in the category
Input the other name.

Current Name:

New Name:

2.4.1.4 Editing a User Graphic Library

To change the name of a library:

- 1 Select a library from the drop-down list.

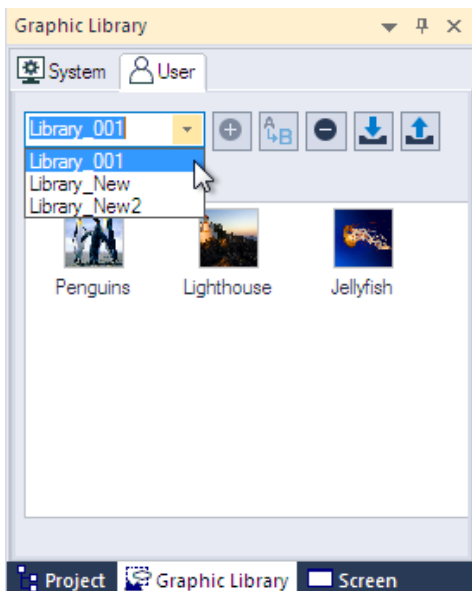

2 Enter a new name, and then click  to save it.

- Graphic library “Library_001” has changed to “Library_001A.”

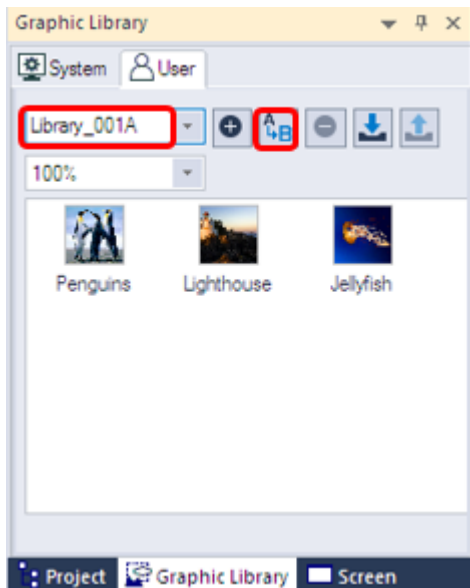

Note

- User graphic libraries are sorted in ascending order by name.
- The name of a system graphic library cannot be changed.
- Supported image types include BMP, JPEG, GIF, WMF, TGA, PNG, TIF, ICO, and PCX.
- Users can create a maximum of 2047 categories, from category number 2049 to 4095. An error message is displayed if you try to create categories exceeding the limit.

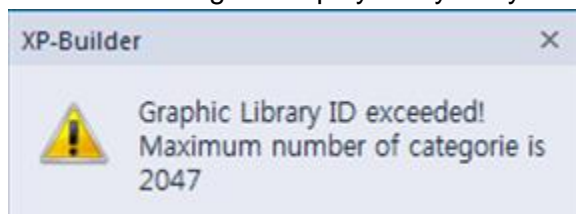

- Each category can have 500 images. An error message is displayed if you try to add more images to a category exceeding the limit.

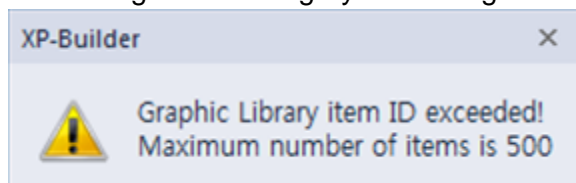

To delete a library:

- 1 In the Graphic Library pane, click the User tab.
- 2 Select a library from the drop-down list and click .

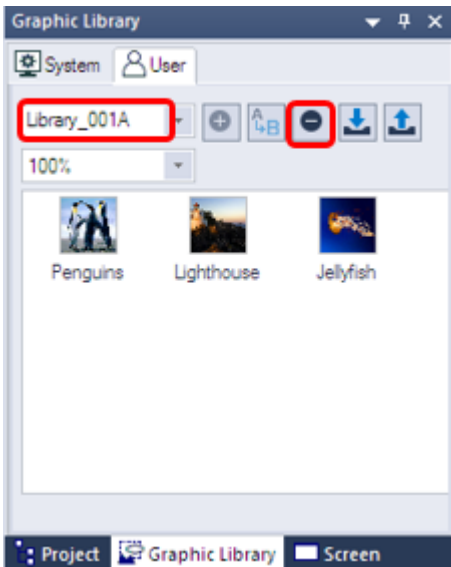

2.4.1.5 Applying Options to the Images

Several options are available when editing, such as setting the transparency value of images and saving them in WMF format so that they maintain resolution when enlarged.

To apply changes to an image, right-click it and select from the following options.

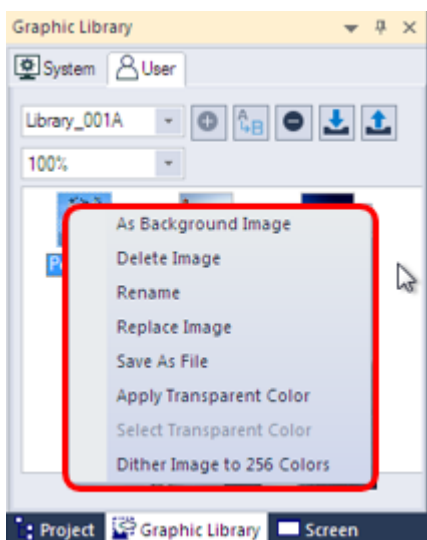

Functions	Description
As Background Image	Set the image as the background image of the current screen. <u>To set an image as a background:</u>

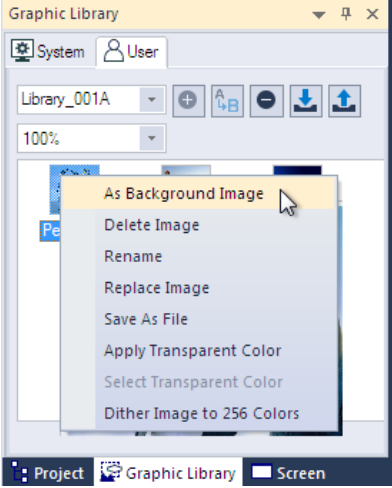
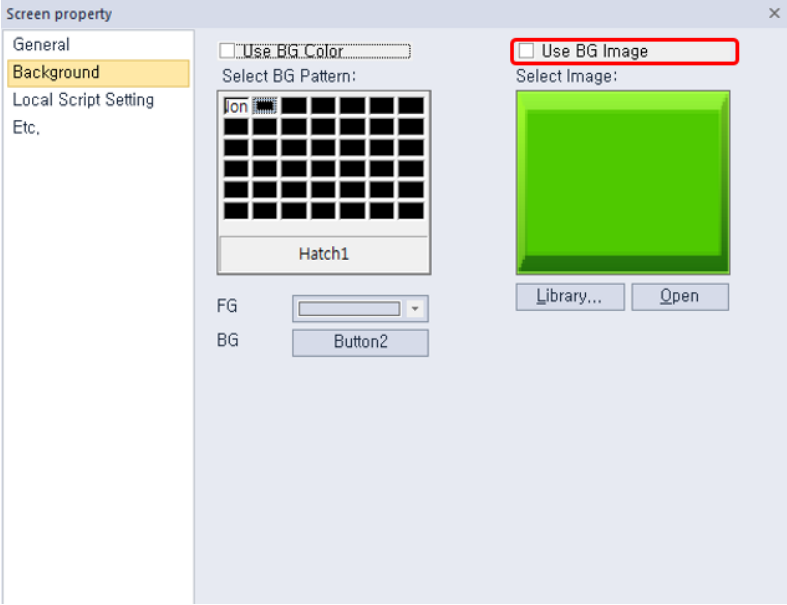
Functions	Description
	<ol style="list-style-type: none"> 1. Select a category from the Graphic Library. 2. Right-click an image and click [As Background Image].  <p>For more information about specifying background images, refer to <2.3.2.4 Changing Screen Properties>.</p> <p><u>To remove a background image:</u></p> <ol style="list-style-type: none"> 1. Right-click the image that is currently set as the background image. 2. Click [Screen Property] ► [Background]. 3. Clear the checkbox next to Use BG Image, and then click [OK]. 
Delete	Deletes an image from the graphic library.
Rename	Changes an image name.

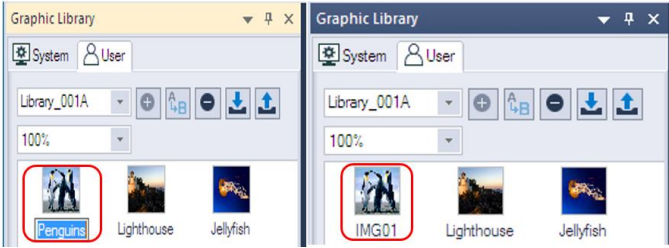
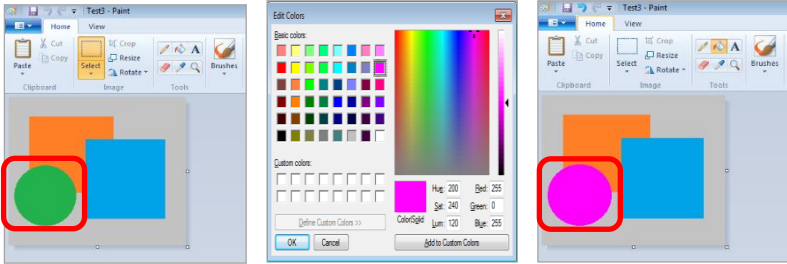
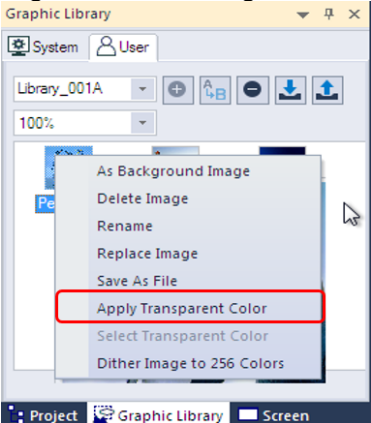
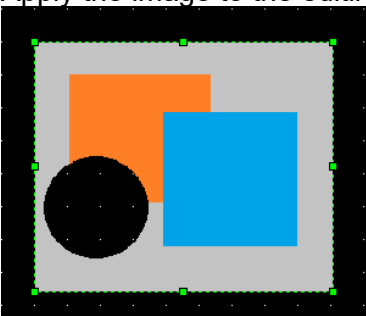
Functions	Description
	
Replace Image	Replaces an existing image with a new image file selected by the user.
Save as File	Exports an image to save it as a file.
Apply Transparent Color	<p>Applies a transparent color to the image (see the following procedure).</p> <p><u>To set the transparency of the image and apply it to XP-Builder:</u></p> <ol style="list-style-type: none"> Open an image in Paint and set the RGB color properties of the part of the image to 255, 0, and 255, to make it transparent. <div data-bbox="443 891 1233 1153">  </div> Register the image in the Graphic library. Right-click the image and click [Apply Transparent Color]. <div data-bbox="443 1238 815 1659">  </div> Apply the image to the editing area to view the transparency settings. <div data-bbox="443 1697 810 2011">  </div>

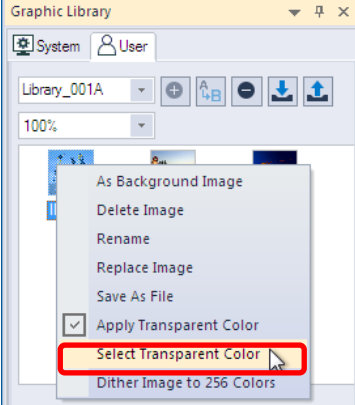
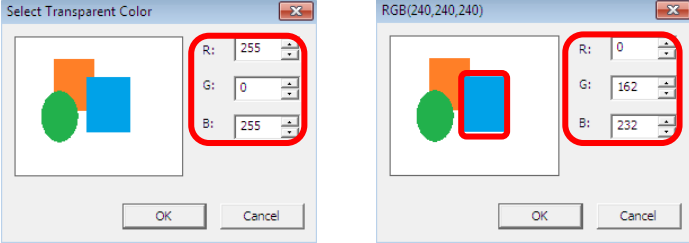
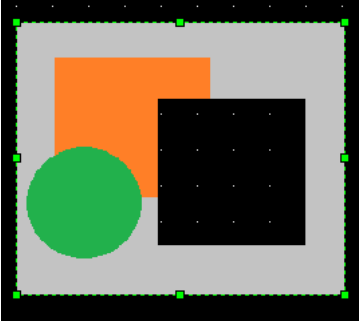
Functions	Description
<p>Select Transparent Color</p>	<p>Set the transparency value of an existing color in the image (see the following procedure).</p> <p><u>To set the transparency of an existing image:</u></p> <ol style="list-style-type: none"> 1. Right-click an image and click [Select Transparent Color].  <ol style="list-style-type: none"> 2. Select the part of the image that you want to make transparent, and then click [OK]. Then, the RGB value for the transparent color will be changed.  
<p>Dither Image to 256 Colors</p>	<p>Change the color value of the image to 256 colors to reduce the size of the file.</p> <p><u>To dither the image to 256 colors:</u></p> <ol style="list-style-type: none"> 1. Add the image to the User graphic library. 2. Right-click an image and click [Dither Image to 256 Colors].

Functions	Description
	 <p>3. Click [OK].</p> <p>Note</p> <p>Once an image is dithered, its color value cannot be restored.</p>

Note

- The default transparent color is RGB (255, 0, 255).
- Setting a transparent color is not a default option.
- You can select multiple images and apply transparency to them simultaneously if the image properties are the same. If the image formats are different or if one of the images has a transparency already applied, the function will not work.
- You can use the dithering function only in projects for color mode panels. After TGA and JPG files are dithered, they are saved as BMP files.
- The image dithering function substitutes colors to the 256 color palette to reduce the image size and number of colors.

2.4.2 Managing Object Libraries

Learn how to manage object libraries. Both the system and user object libraries can be managed, but only user object libraries can be edited. For more information about inserting or editing objects, refer to <2.3.4.4 Inserting Objects from the Object Library> and <2.3.5 Editing Objects>.

Type	Description
System Object Library	Includes seven categories: Alarm and Logging, Keypad, Lamp, Pushdown_Switch, Rotary_Switch, Slide_Switch, Toggle_Switch. The system objects cannot be edited.
User Object Library	You can register, modify or delete objects. The objects are saved in the current project and not in the XP-Builder program. You can import a user object library from another project or export it from the current project to use in other projects.

To open the Object Library pane, click [VIEW] ► [Object Library]. The Object Library pane will appear, as shown in the following image:

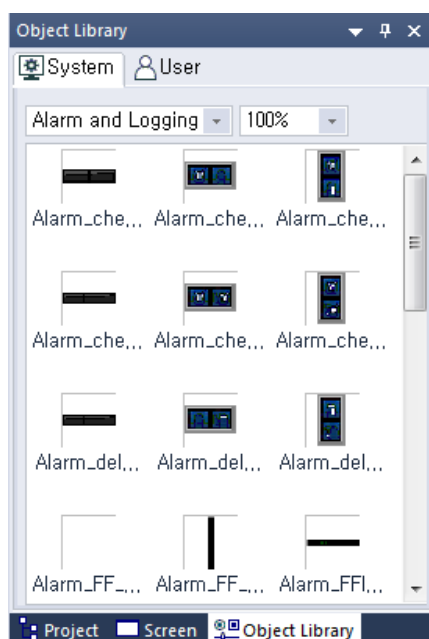

Note

- A dropdown filter is provided at the top of the Object Library pane to allow you to find specific objects you are looking for. Select an object category to view.

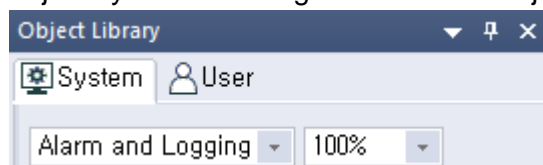

- You can also zoom in or out of object images by selecting one of the magnification presets from the dropdown list.
- A tooltip is displayed to show the object information and the object is magnified for a detailed view

when you move the mouse cursor over images in the library.

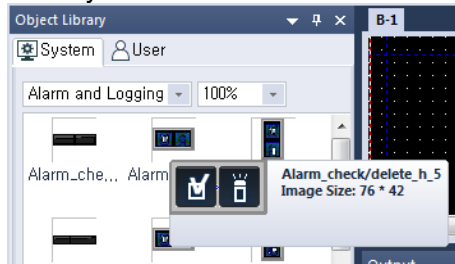

- After inserting an object on the screen, you can double-click it, select it, and press the ENTER key, or right-click it and select [Object Property] to modify the object properties.
- When you drag an object to the editing area, the object is created at the default size. The default sizes of objects vary.

2.4.2.1 Creating a User Object Library

To create a user library:

- 1 In the Object Library pane, click the **User** tab.

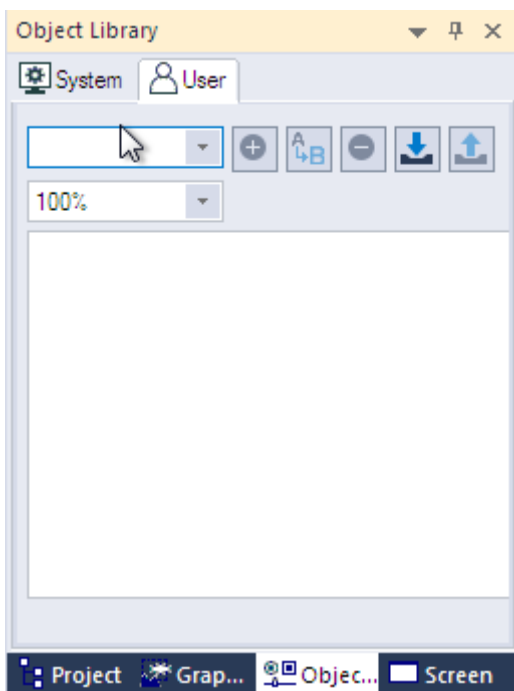

- 2 Enter a category name and click . A new object category will be created.

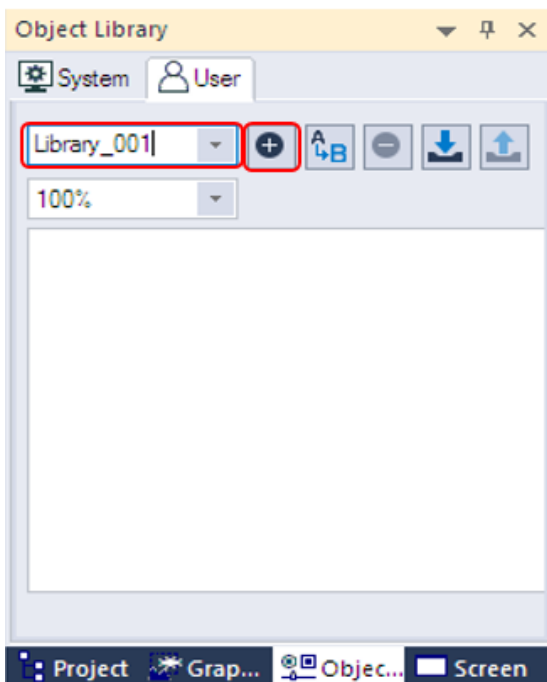

- 3 Drag objects from the editing area to the Object Library pane. You can select multiple objects/figures and register them as one object.

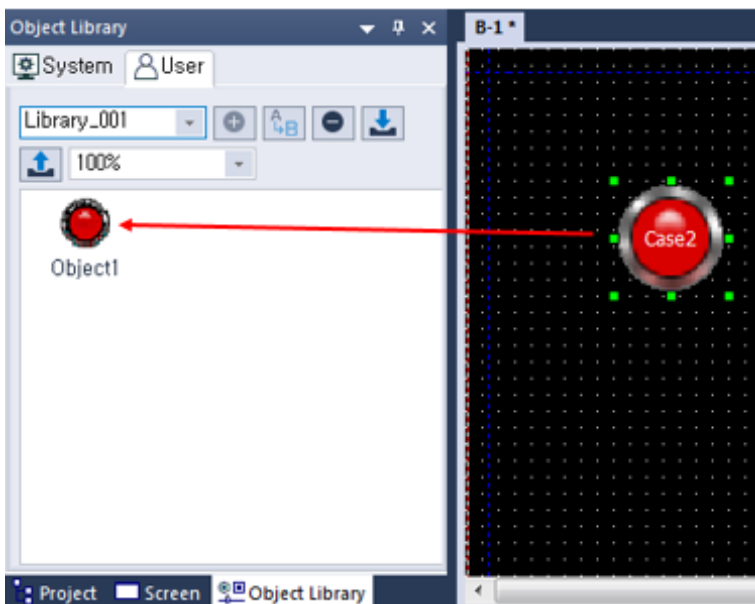

- 4 Right-click the newly added object and select [Rename] to change the name of the object.

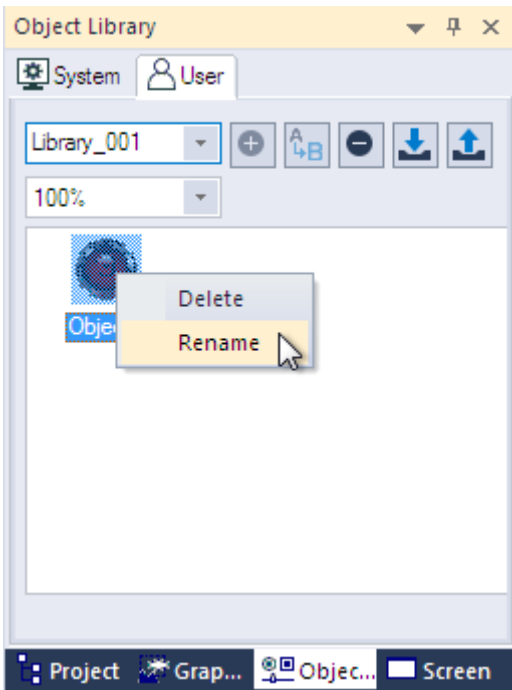

Note

To delete objects, right-click an object and then click [Delete]. To delete all objects, right-click an empty area in the Object Library pane, and then click [Delete All Objects].

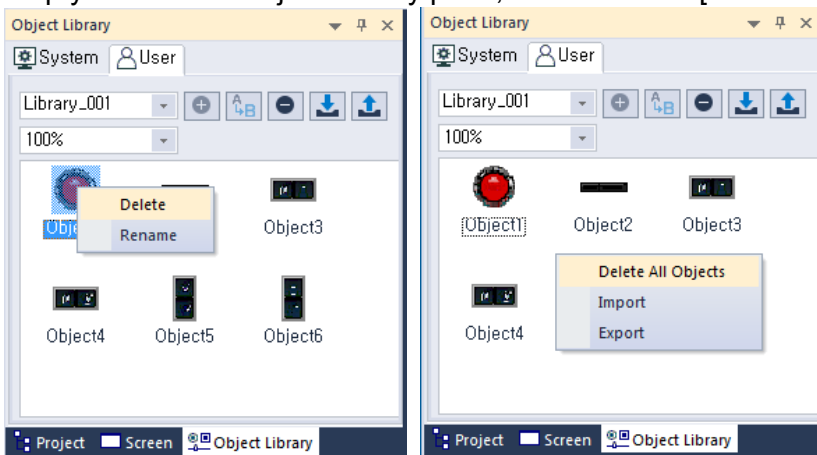

2.4.2.2 Exporting a User Object Library

To export the user object library after creating it:

- 1 In the Object Library pane, click the **User** tab.

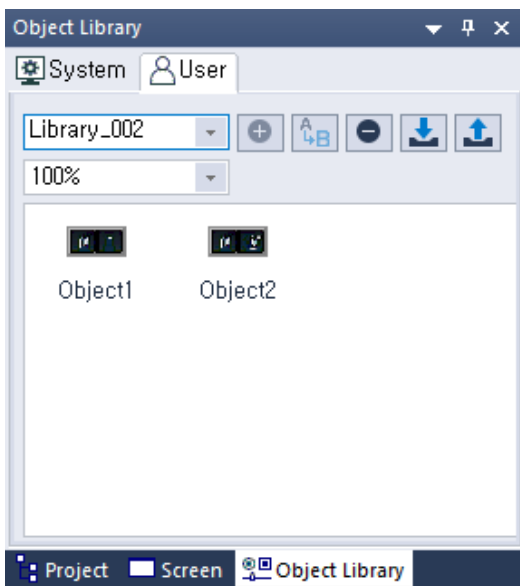

- 2 Select a library to export from the drop-down list and click .

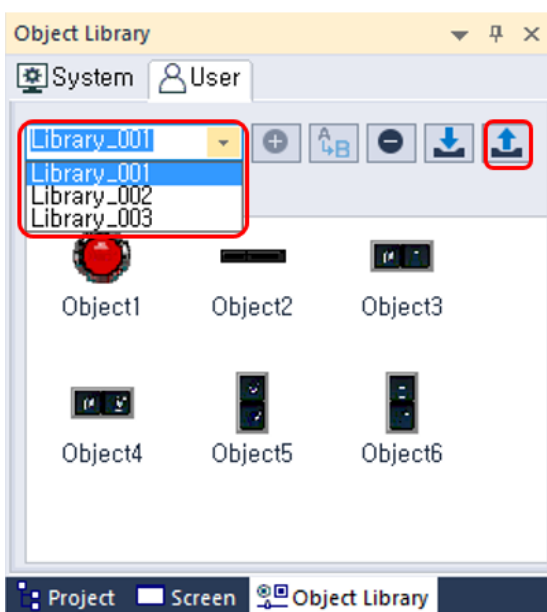

- 3 Enter a name for the file and set the file destination.
4 Click [Save].

Note

- The exported library is saved as an .xpo file.
- You can also export the current category (library) by right-clicking an empty area in the Object Library pane, and then clicking [Export].

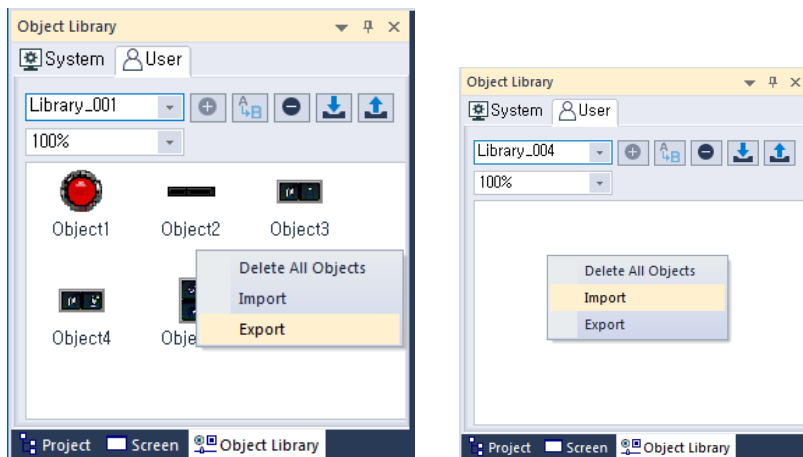

2.4.2.3 Importing a User Object Library

You can either import a library into a project as a new library or you can import objects into an existing user object library.

To import a new library:

- 1 In the Object Library pane, click the **User** tab.
- 2 Click .

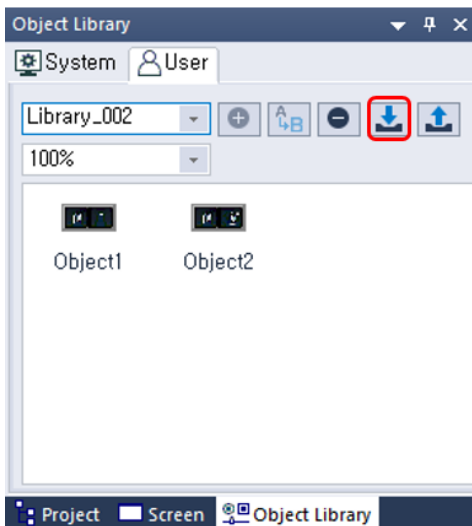

- 3 Select an .xpo file and click [Open]. You can also select multiple files to add.

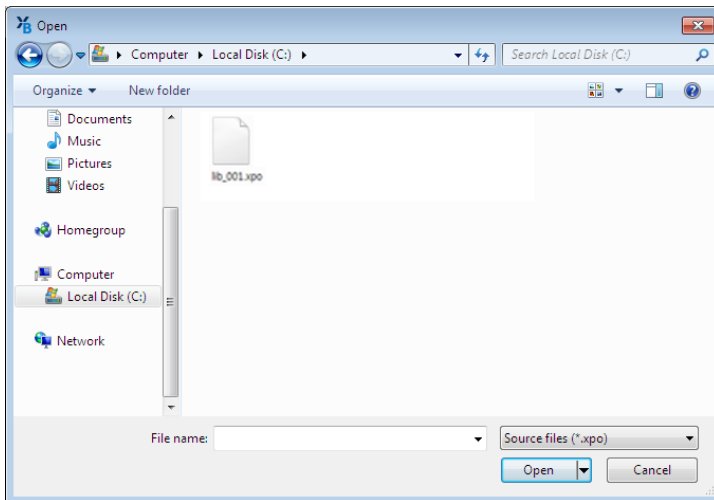

- The new library will be added to the Object Library List.

To import objects into an existing library:

- 1 In the Object Library pane, click a user object library name.
- 2 In the Object Library pane, right-click an empty area, and then click [Import].

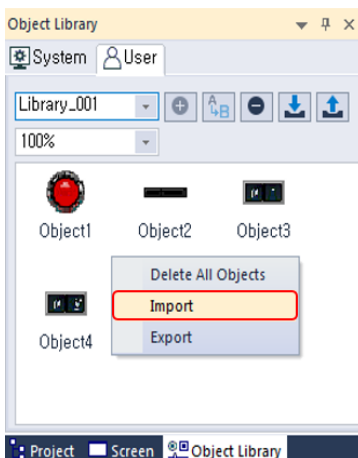

- 3 Select an .xpo file and click [Open]. The objects in the library file you selected will be added to the existing library.

Note

- Users can create a maximum of 57,343 categories, from category number 8,193 to 65,535. An error message is displayed if you try to create categories exceeding the limit.

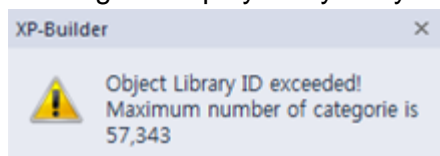

- Each category can have 500 images. An error message is displayed if you try to add more images to a category exceeding the limit.

- User object libraries and the objects in the library are sorted by names in ascending order when you add or rename a library.

2.4.2.4 Editing a User Object Library

To change the name of the library:

- 1 Select a library from the drop-down list.

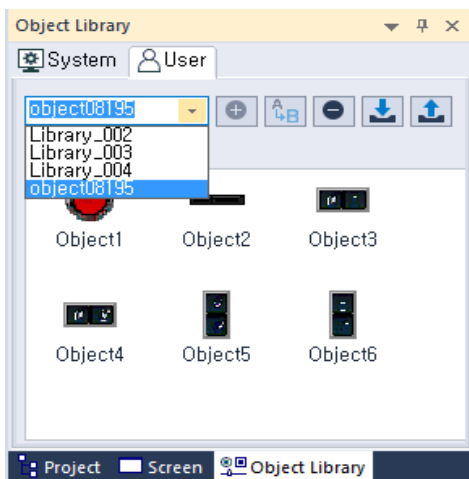

- 2 Enter a new name, and then click  to save it.

- Object library “object08195” has changed to “Library_002.”

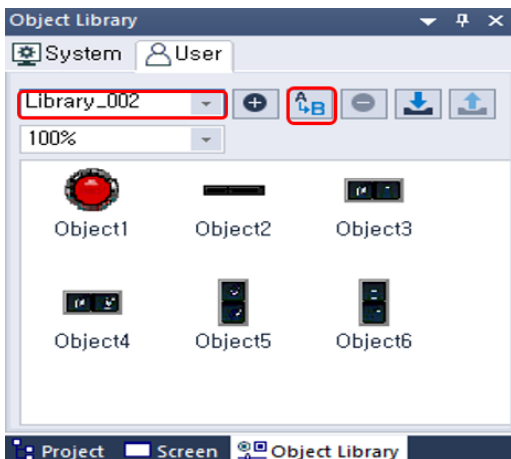

To delete a library:

- 1 In the Object Library pane, click the **User** tab.
- 2 Select a library from the drop-down list and click .

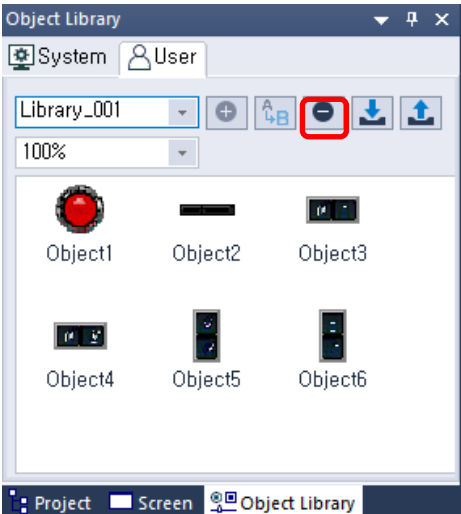

2.5 Connecting Controllers

Configure the communication settings for the XGT Panel and controller. To connect an XGT Panel to the controller, use an Ethernet connection and the serial port. In the serial ports, there are three connection methods: RS232C, RS485, and RS422. This section describes how to set the communication method. For more details about XGT Panel settings, refer to **<2.2.2.2 Changing XGT Panel Settings>**.

2.5.1 Connecting via an Ethernet Cable

Connect the XGT Panel to the controller with an Ethernet cable.

To set the configure Ethernet options:

- 1 Click [COMMON] ► [Project Property Setting] ► [XGT Panel Settings].

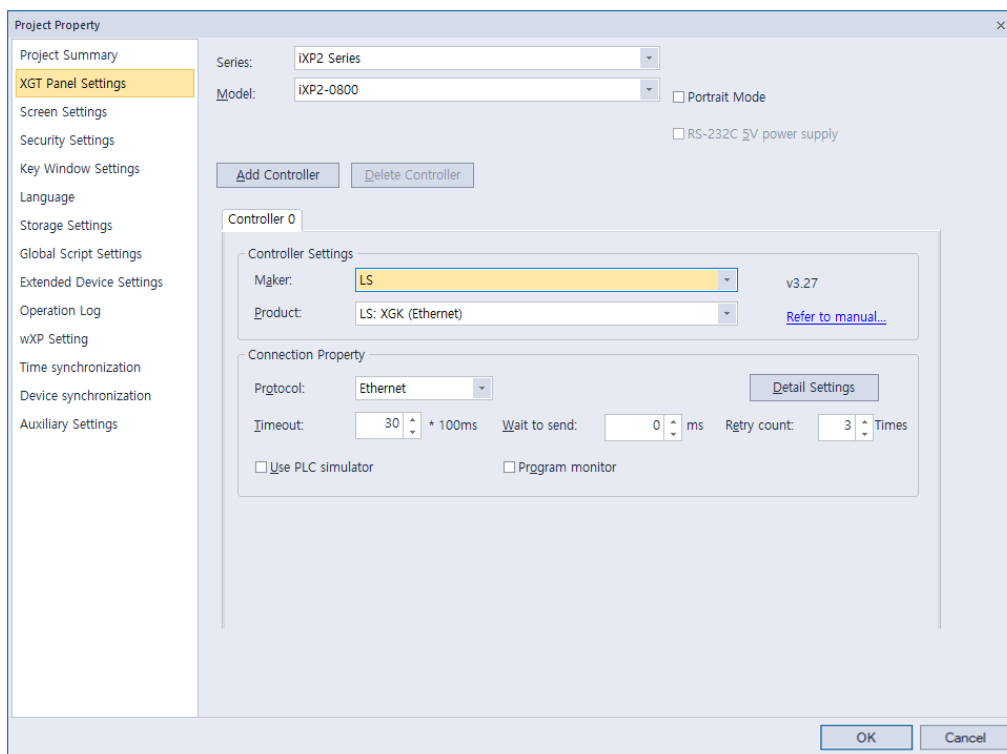

- 2 Select the XGT Panel series and model name.

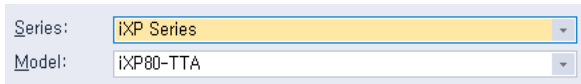

- 3 Set the controller manufacturer and the controller model (Product). Select a product with “Ethernet” at the end of the controller name.

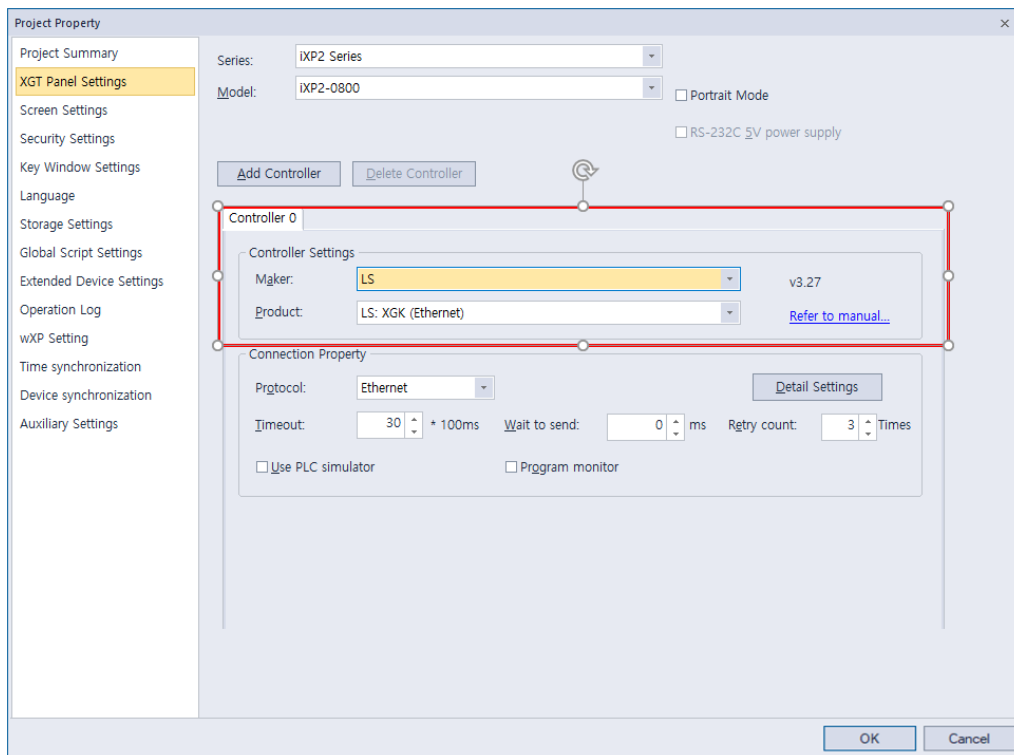

4 Set the protocol to **Ethernet**.

5 Select **Detail Settings**, configure the IP settings, and click [OK].

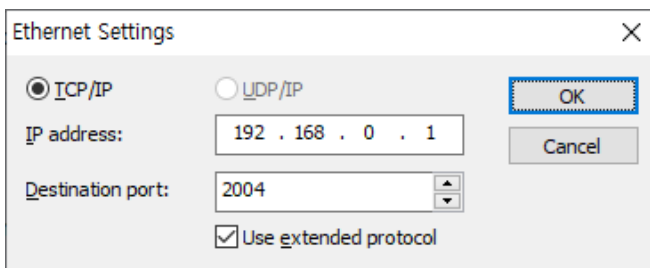

6 Set the additional connection properties in the **Connection Property** section and click [OK].

2. Project Development

Project Property

Project Summary

XGT Panel Settings

Screen Settings

Security Settings

Key Window Settings

Language

Storage Settings

Global Script Settings

Extended Device Settings

Operation Log

wXP Setting

Time synchronization

Device synchronization

Auxiliary Settings

Series: IXP2 Series

Model: IXP2-0800

Portrait Mode

RS-232C 5V power supply

Add Controller Delete Controller

Controller 0

Controller Settings

Maker: LS v3.27

Product: LS: XGK (Ethernet) [Refer to manual...](#)

Connection Property

Protocol: Ethernet [Detail Settings](#)

Timeout: 30 * 100ms Wait to send: 0 ms Retry count: 3 Times

Use PLC simulator Program monitor

OK Cancel

2.5.2 Connecting via a Serial Port

Connect the XGT Panel to the controller via a serial port. You can select RS232C, RS485, or RS422.

2.5.2.1 Using RS232C

- 1 Click [COMMON] ► [Project Property Setting] ► [XGT Panel Settings].

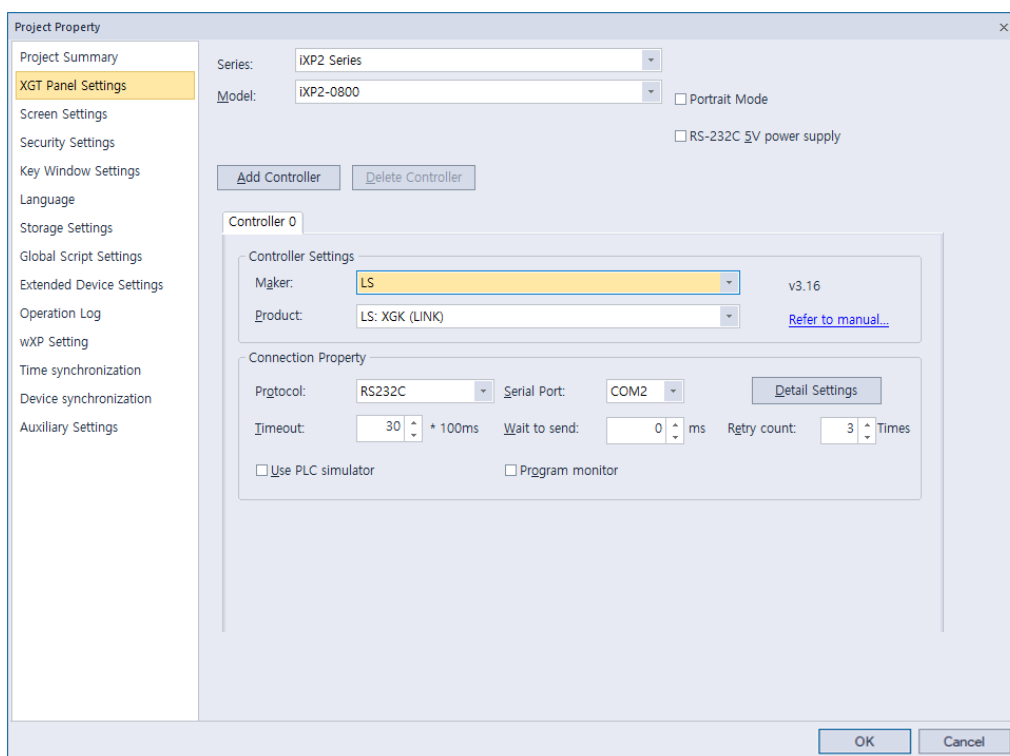

- 2 Select the XGT Panel series and model name.



- 3 Set the controller manufacturer and the controller model (Product). Select a product with “LINK” at the end of the controller name.

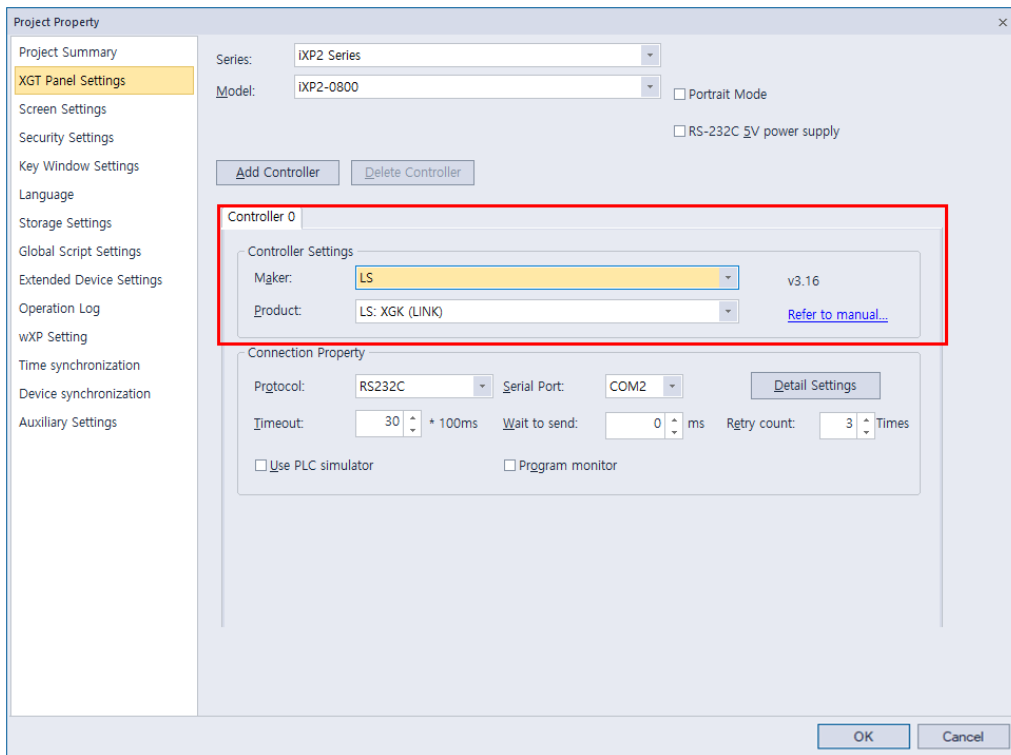

4 Set the protocol to **RS232C** and select a serial port.

5 Select **Detail Settings**, configure the properties, and click [OK].

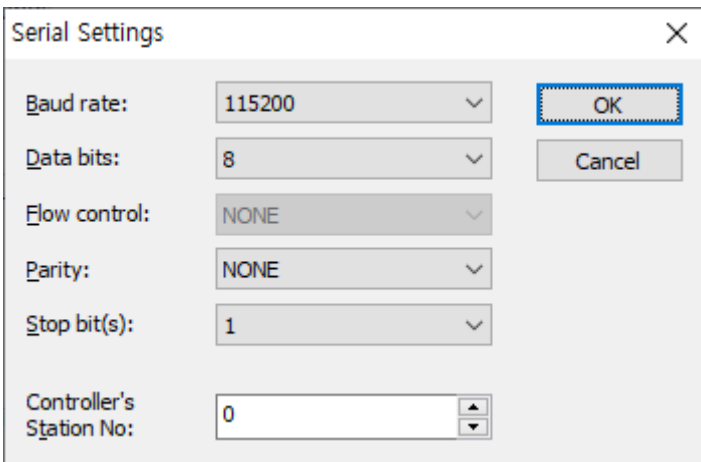

Note

- The baud rate must match the setting in the XGT Panel. To change the baud rate on the XGT Panel, tap and hold the screen to access the menu. Then, tap [PLC Information], select a driver from the Driver list, tap [Settings], and set the baud rate.
- **Station** stands for the station ID of the PLC. HMI station number is used only in N:1 communication settings.

6 Set the additional connection properties and click [OK].

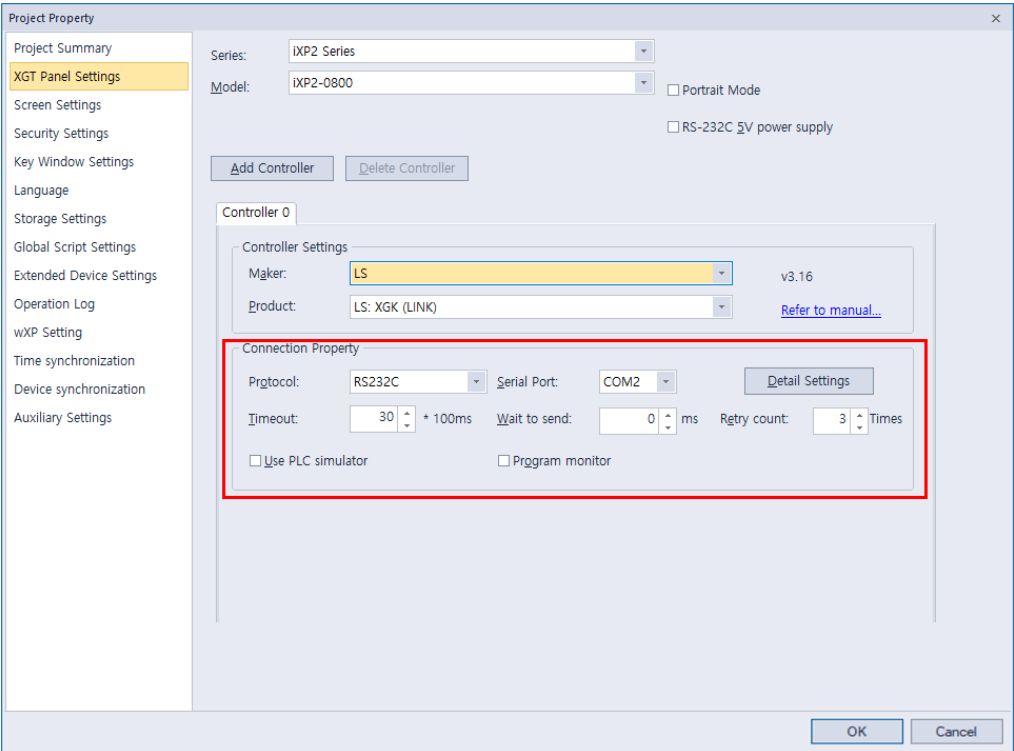

2.5.2.2 Using RS485/RS422

- 1 Click [COMMON] ► [Project Property Setting] ► [XGT Panel Settings].

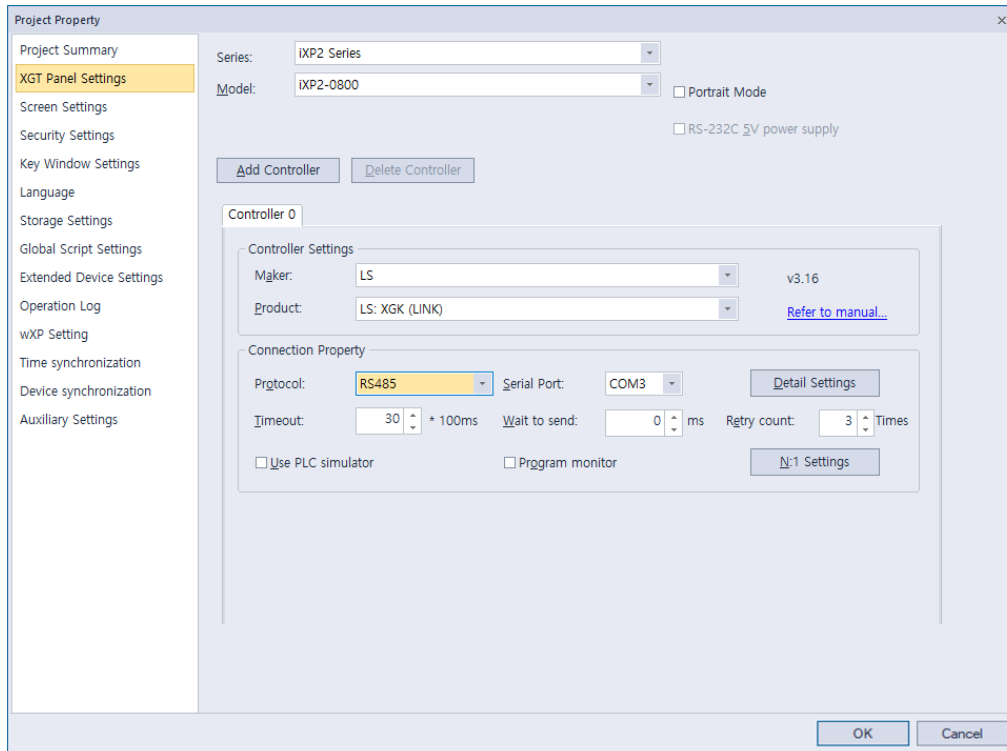

- 2 Select the XGT Panel series and model name.

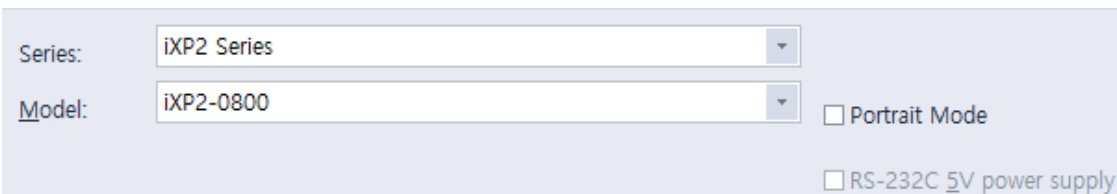

- 3 Set the controller manufacturer and the controller model (Product). Select a product with "LINK" at the end of the controller name.

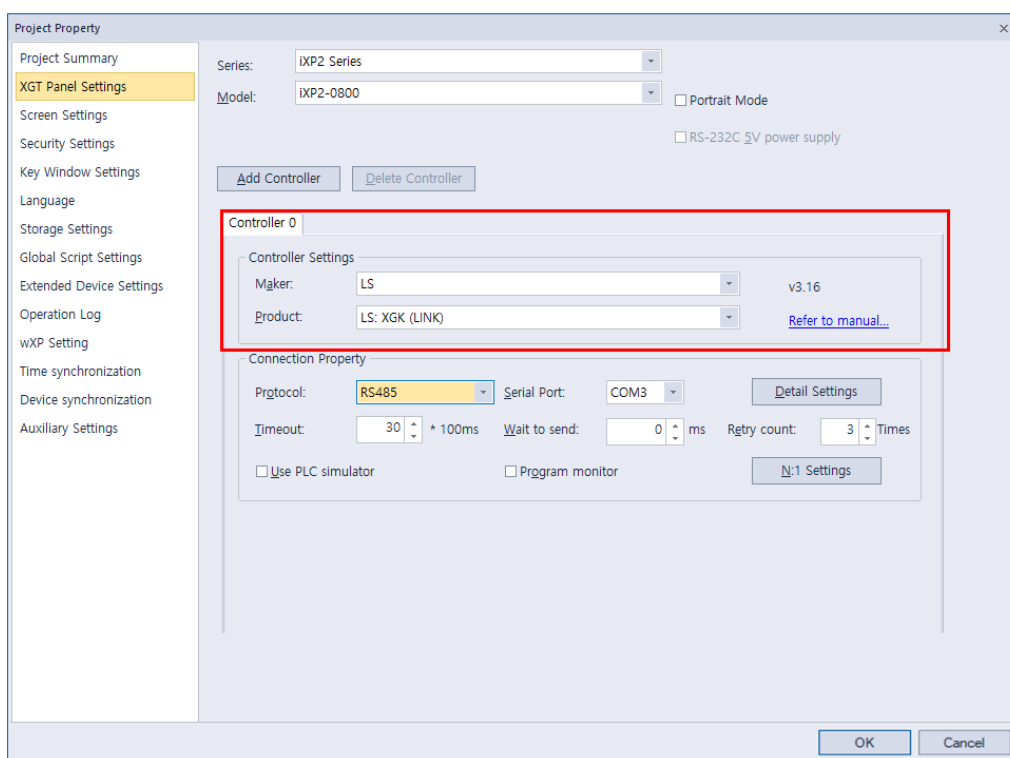

- 4 Set the protocol to **RS485** or **RS422** and select a serial port.
- 5 Select **Detail Settings**, configure the properties, and click [OK].

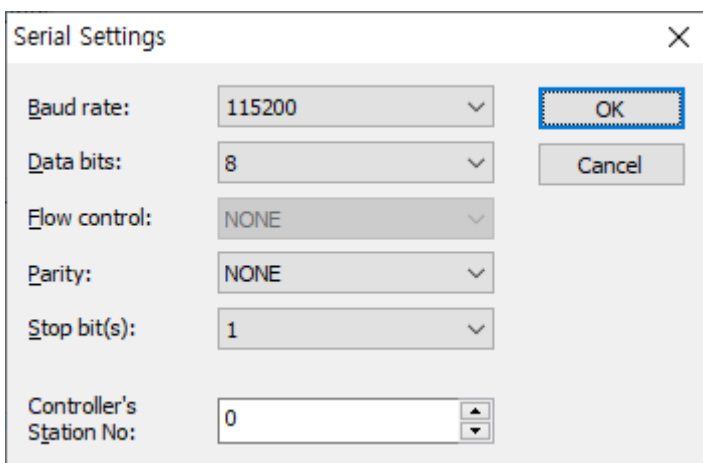

Note

- The baud rate must match the setting in the XGT Panel. To change the baud rate on the XGT Panel, tap and hold the screen to access the menu. Then, tap [PLC Information], select a driver from the Driver list, tap [Settings], and set the baud rate.
- **Station** stands for the station ID of the PLC. HMI station number is used only in N:1 communication settings.

- 6 Set the additional connection properties and click [OK].

2. Project Development

Project Property

Project Summary

XGT Panel Settings

Screen Settings

Security Settings

Key Window Settings

Language

Storage Settings

Global Script Settings

Extended Device Settings

Operation Log

wXP Setting

Time synchronization

Device synchronization

Auxiliary Settings

Series: IXP2 Series

Model: IXP2-0800

Portrait Mode

RS-232C 5V power supply

Add Controller Delete Controller

Controller 0

Controller Settings

Maker: LS v3.16

Product: LS: XGK (LINK) [Refer to manual...](#)

Connection Property

Protocol: RS485 Serial Port: COM3 [Detail Settings](#)

Timeout: 30 + 100ms Wait to send: 0 ms Retry count: 3 Times

Use PLC simulator Program monitor [N:1 Settings](#)

OK Cancel

2.6 Simulating & Debugging

After developing an interface, it is a good idea to test it before putting it to use. XP-Builder offers multiple ways to check the integrity of your data, including an interface simulator, data check and device map functions, and a script cross-reference that can help you debug your program.

2.6.1 Simulating an Interface

The simulator provided in XP-Builder allows you to verify the functionality and appearance of your interface before you transfer it to an XGT Panel. By testing your project, you can correct errors and verify system operations and responses in advance.

To run the simulator:

1 Click [Tool] ► [Simulation].

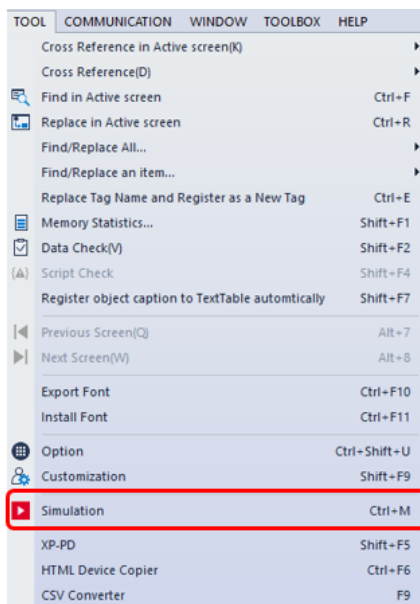

Note

- Except for the menu and title, the simulation window will use the same resolution as when it is exported to an XGT Panel.
- Only one simulator can be run at a time. If you are running the simulator, you cannot execute another one.
- The size of simulator window may vary according to the set XGT Panel size.
- Click and move the Simulation window borders to control screen size. Note that the display resolution remains the same and may make margins.

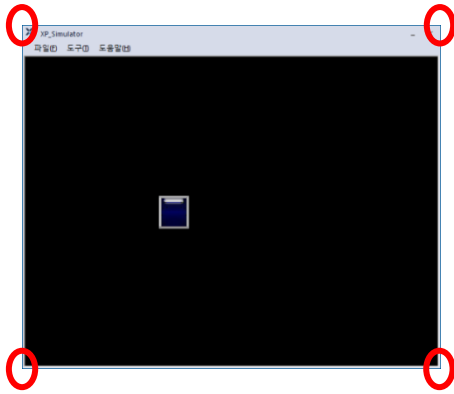

- The OPC UA Client and OMRON NX/NJ Ethernet/IP do not support simulators.

2 Verify operations by clicking or selecting objects and activating functions in the interface. As shown in the following example, you can virtually input the value and review the operation via the simulation.

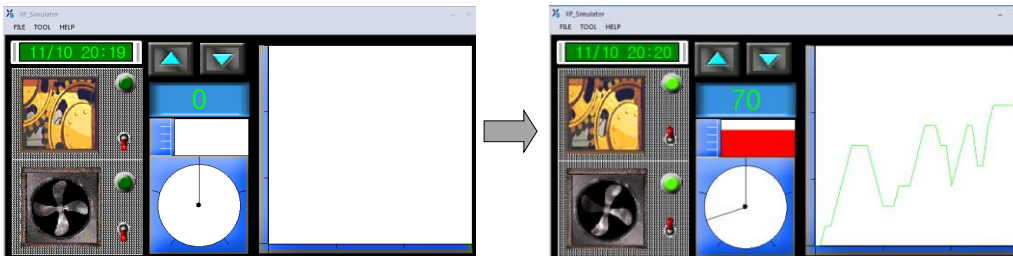

- The simulator interface includes the following functions:

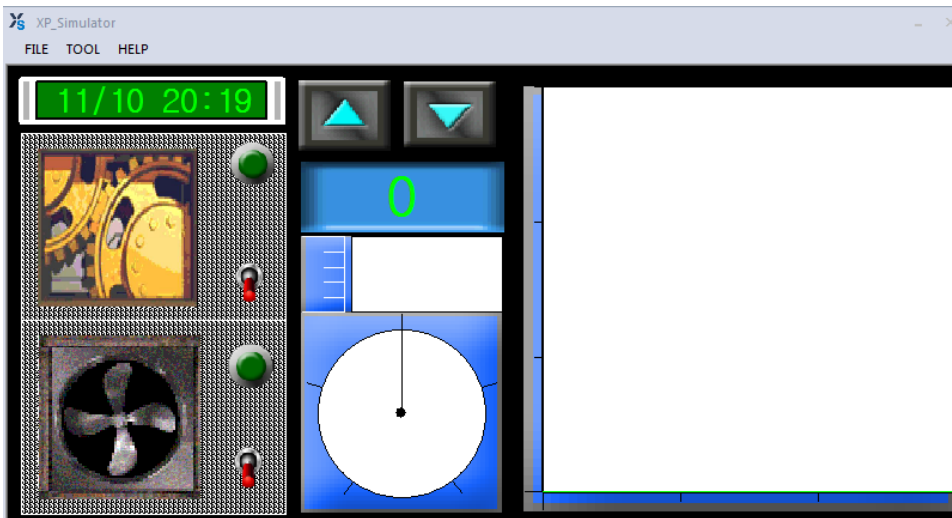

Function		Description
File	Exit	Ends the simulation and closes the window.
Tool	Virtual Device Start	Monitors and controls a device for simulation. For more information, refer to <2.6.2 Inputting Simulated Data> .
	Screen Capture	Captures an image of the current

Function	Description
	screen.
Help	XP simulator Information (A) Displays the current version information.

2.6.2 Inputting Simulated Data

Learn how to create the simulated data and change the values to check the process.

2.6.2.1 Monitoring Devices

Use the simulator to generate sample data that you can use to monitor devices.

- 1 Click [Tool] ► [Simulation].
- 2 In the simulator, click [Tool] ► [Virtual Device Start].

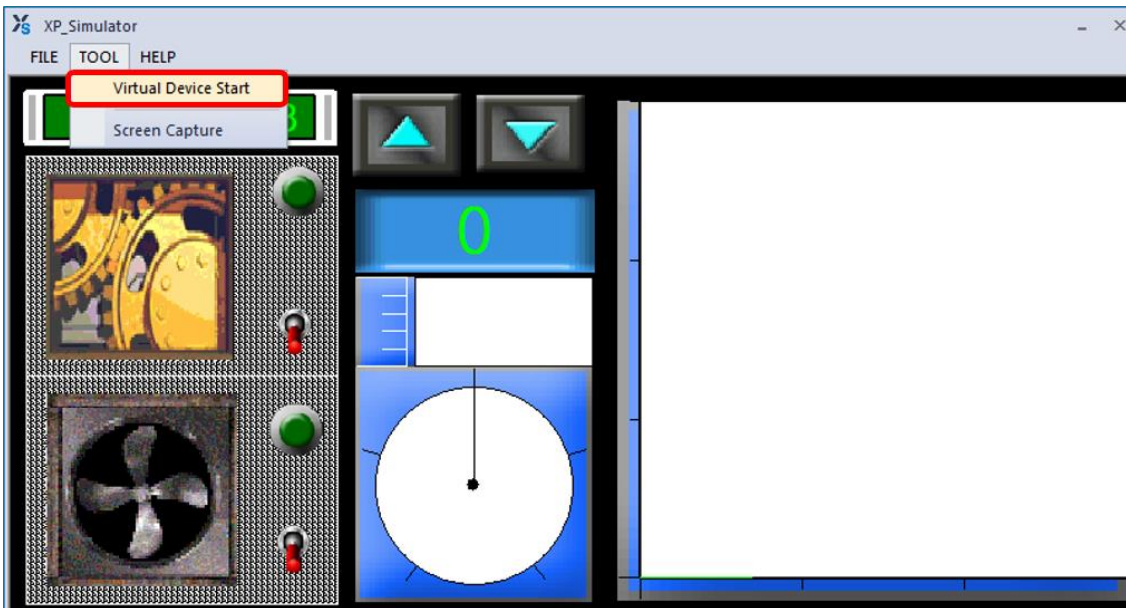

- Device lists with simulated data will appear.

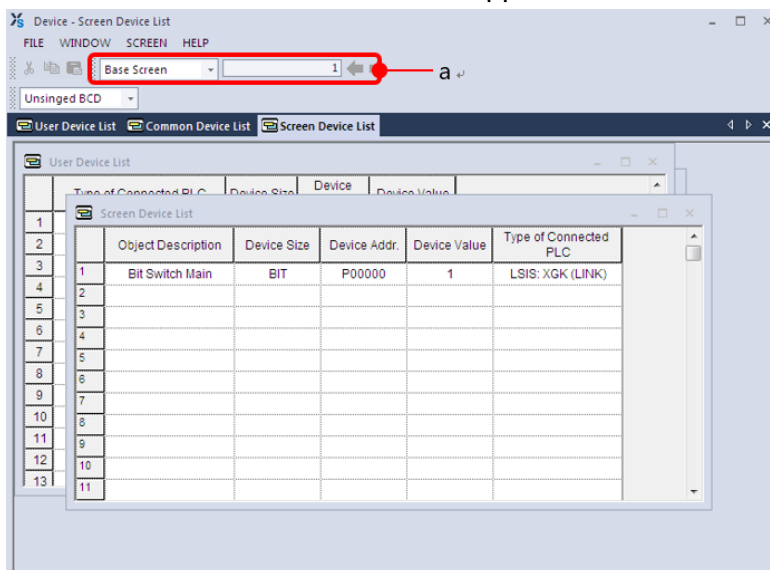

Data Type	Description
a	Sets the type of screen and number of screens that you want to monitor. All base screens with objects and window screens can be selected from the combo box, but you cannot monitor common data devices. The simulator changes the display based on the number of screens you select.
User Device List	Sets the device value manually to simulate the project.
Common Device List	Displays a list of common data, such as History Alarms, Recipes, and Flow Alarms.
Screen Device List	Displays a list of all the edited objects in the base screen.
Object Description	Displays the object name of the device.
Device Size	Displays the size of the device: Bit, 16-bit (word), or 32-bit (double word).
Device Addr.	Displays the address of the device.
Device Value	Displays the value of the current device.
Type of Connected PLC	Displays the controller type.

2.6.2.2 Changing Device Values

Set device information and change values in the User Device List. You can set bit devices to On or Off and manually enter device values for word devices. Values are applied to the simulator as soon as you change them.

2. Project Development

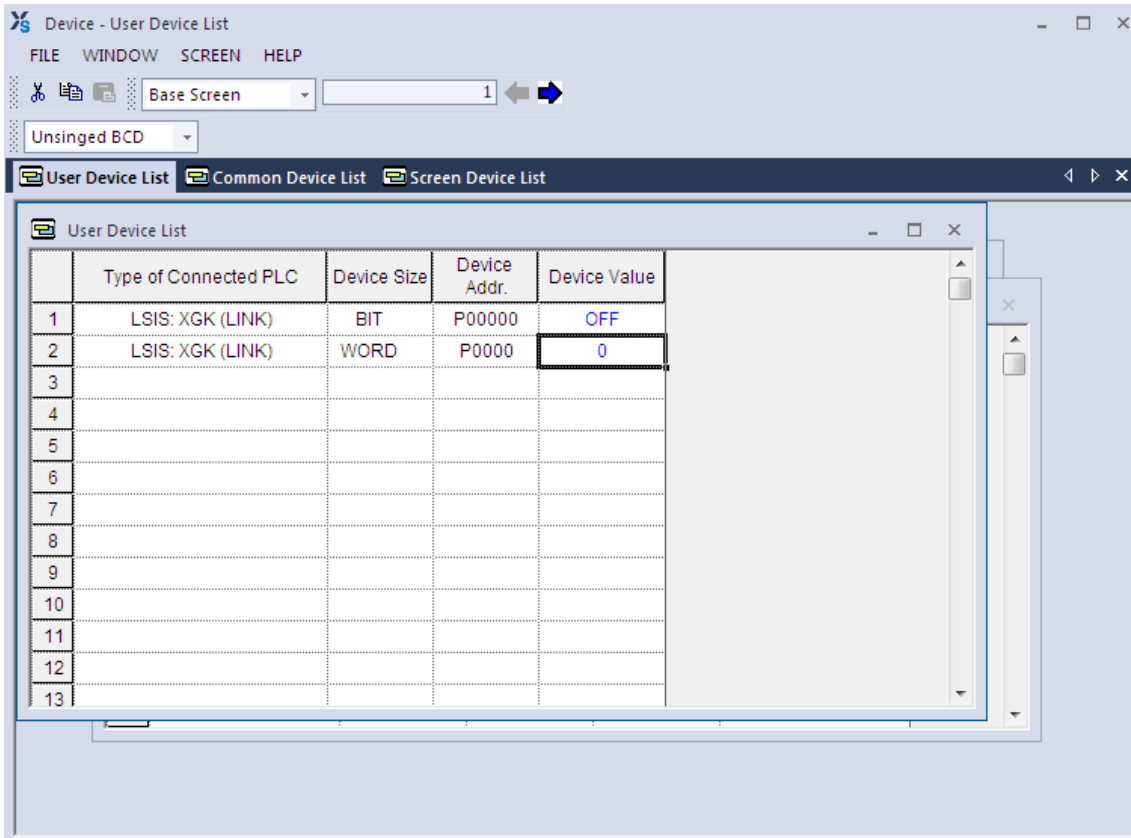

Note

To use the XG5000 with the simulator, click the checkbox next to **Use XG5000 simulator** in the XGT Panel Settings.

2.6.3 Running a Data Check

The data check allows you to locate and correct data errors before transferring a project to an XGT Panel. You can verify deleted image numbers, tags, display numbers, existing addresses, and errors unique to objects or common items. For more information about the messages that are displayed during a data check, refer to **<3. Error Messages>**.

To run a data check, click [Tool] ► [Data Check]. Error numbers and their descriptions will appear in the output window.

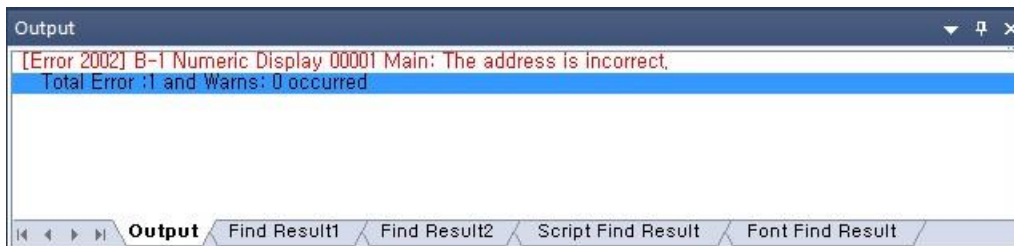

Note

If you close all the project screens and double-click on an item in the output window, you can activate screens or objects that correspond to error messages, so that you can modify them. Refer to **<3.1 Resolving Error Codes Found in the Results Pane>** for detailed information.

2.6.4 Viewing the Device Map

The Device Map allows you to view the locations, addresses, or tag names of devices in the project.

To view the device map:

- 1 Click [View] ► [Device Map].

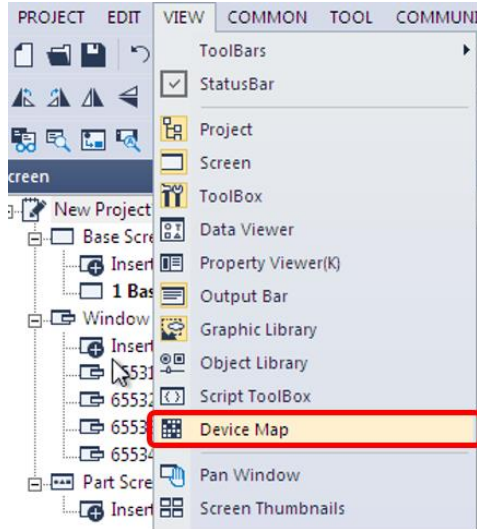

- 2 Click the drop-down list to select a device type (Bit or Word).

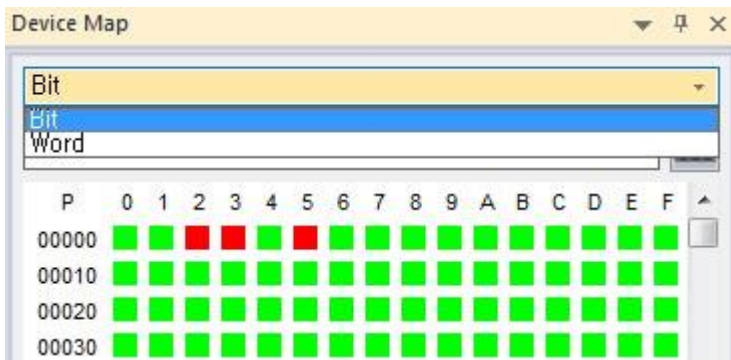

3 Enter a device address or click the keypad icon to the right of the device input area to specify a device address.

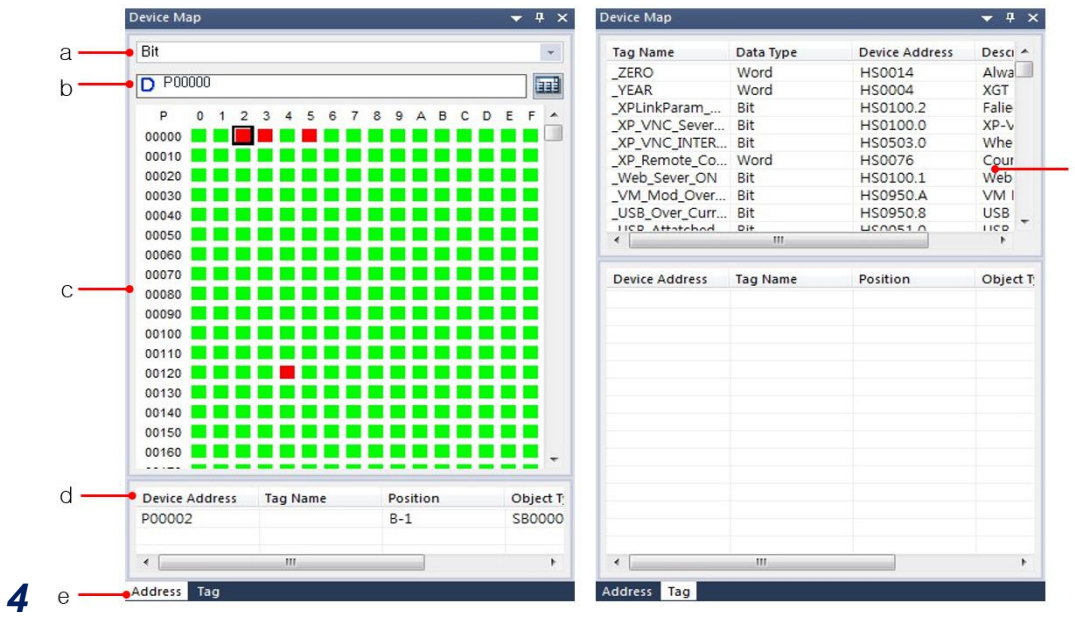

4

<By address>

<By tag>

Item	Description
a. Device Type	Inputs a device type to search for (Bit or Word).
b. Device Address	Input a device address to search for and then press the Enter key.
c. Device Map	Displays the device addresses in use.
d. Device Reference	Displays the currently selected device and its position in the device map.
e. Address or Tag Tabs	Displays information by address or by tag.
f. Tag List	Displays the tags registered to each device.

2.6.5 Evaluating Project Size (Memory Usage)

When the current project data is transferred to an XGT Panel, the files are saved and transferred as .HMI files. The size of an HMI file must not exceed the memory limit of the XGT Panel, so it is important to know the size of the HMI files and components of the current project.

To evaluate the project size:

- 1 Create a project, as described in <2. Project Development>.
- 2 Select [Tool] ► [Memory Statistics]. The memory size of each element is shown, including screens and common data.

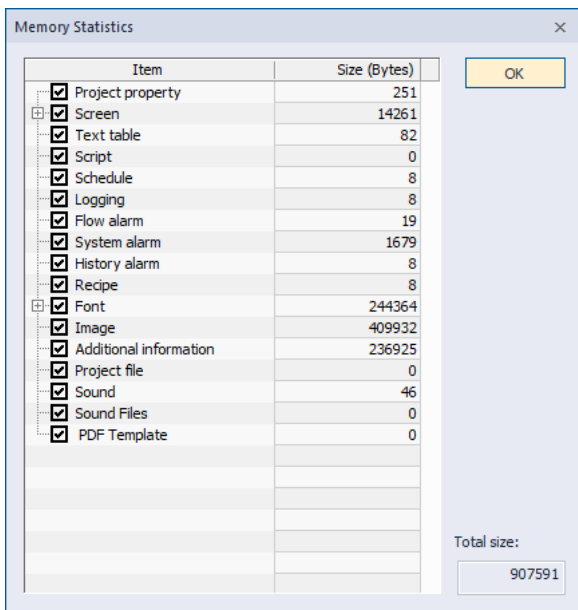

Note

- The memory size of the screen element includes the sizes of figure and objects and does not include the sizes of images and fonts used on the screen. Image and font sizes show their sizes for the entire project. If an image is used more than once in a project, the information of a single image is transferred to the XGT Panel.
- If the memory required for images, projects, sounds, or recipe data is quite large, you can set the storage location for those files to an external drive that is connected to the XGT Panel.
- Additional information includes the information of various drivers such as the communication driver module.

2.6.6 Finding and Replacing Devices

This function allows you to locate the addresses of objects used in a project and, if necessary, relocate them to a new address.

2.6.6.1 Finding and Replacing Devices on the Active Screen

To find and replace devices on the active screen:

- 1 Click [Tool] ► [Find in Active Screen]. The object's address is shown in the Find Device window.

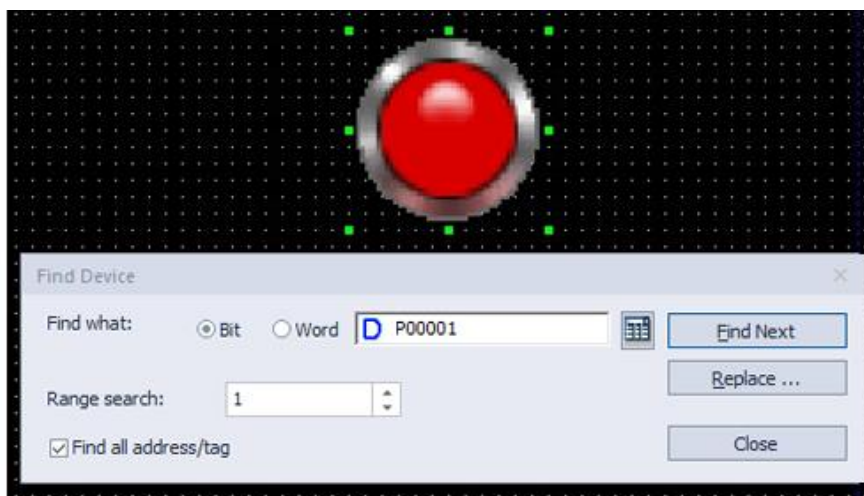

- 2 Click [Find Next] to find another object with the same address.
- 3 To change the address of a device, click [Replace]. The Replace Device window will appear.

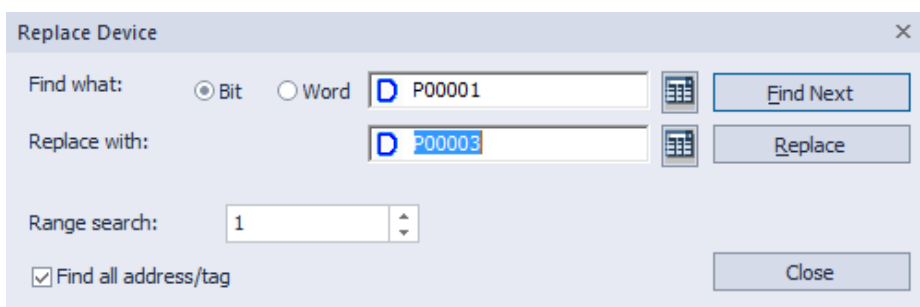

- 4 Enter a new address in the **Replace With** field or click the keypad to the right of the field to specify a device address.
- 5 After entering the new device address, click [Close].

Note

- You can also click [Tool] ► [Replace in Active Screen] to directly access the Replace Device window.
- By default, the Find function locates either device addresses or tags, based on the type of information that you specify. To search for device addresses and tags, check the check box next to

Find All Addresses/Tags.

- To locate a range of addresses, set the range in the **Range Search** field. By default, the range is “1,” which returns a single device address. You can also replace addresses automatically in a range from a specified starting point, for as many devices as you specify in the **Range Search**.

2.6.6.2 Finding and Replacing All Devices

To find all devices used in objects of a particular type at once:

- 1 Click an object to select it, and then click [Tool] ► [Find/Replace All] ► [Device]. The current object's device address is shown in the Find All window.

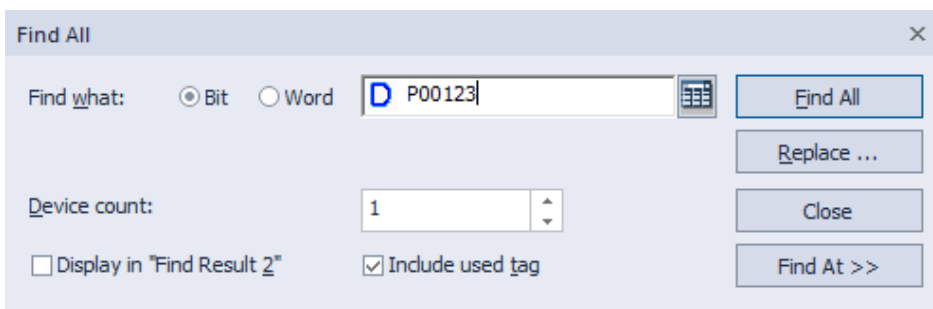

- 2 Click device types and enter the device address to find in the **Find What** field. By default, the search range is the entire project.

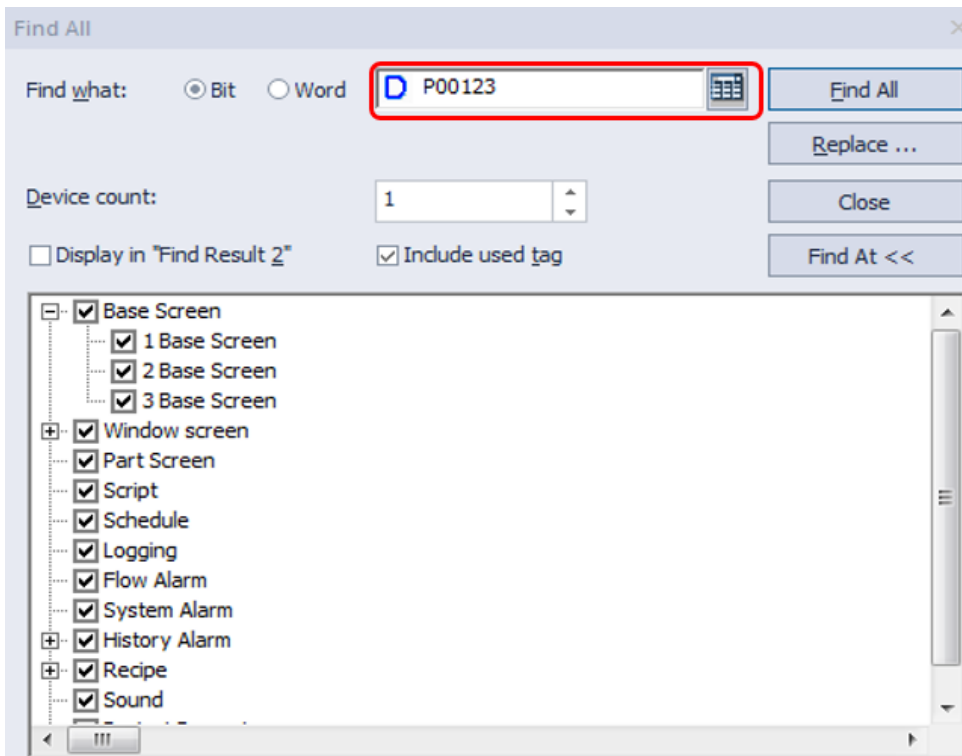

- Click [Find All]. The output window shows the results of the search. You can double-click a column to view details about the object.

Device Address	Tag Name	Position	Object Type	Description
P00123		B-1	SB00001	Bit Switch Main
P00123		B-1	SB00002	Bit Switch Main
P00123		B-1	SB00003	Bit Switch Main
P00123		B-1	SB00004	Bit Switch Main
P00123		B-1	SB00005	Bit Switch Main
P00123		B-1	SB00006	Bit Switch Main

To replace all objects in a range of addresses at once:

- Click an object to select it, and then click [Tool] ► [Find/Replace All] ► [Device]. The current object's device address is shown in the Find All window.

Find All

Find what: Bit Word

Device count:

Display in "Find Result 2" Include used tag

- Click [Replace].
- Enter the original device address in the **Find what** field and the new address in the **Replace with** field.

Replace All

Find what: Bit Word

Replace with:

Device count:

Display in "Find Result 2" Include used tag

- Click [Replace All].
- Click [Yes] to confirm the address replacement. The output window shows the number of the replaced addresses.

Note

To replace addresses in a specified range, change the **Device Count** setting. Addresses will be replaced for the number of devices you specify. For example, if the original device address is P0 and the Device Count is 7, then 7 devices, including P0, are replaced.

2.6.6.3 Finding and Replacing All Fonts

To find all fonts used in the project at once:

- 1 Click an object to select it, and then click [Tool] ► [Find/Replace All] ► [Font]. The Find/Replace Font window opens.

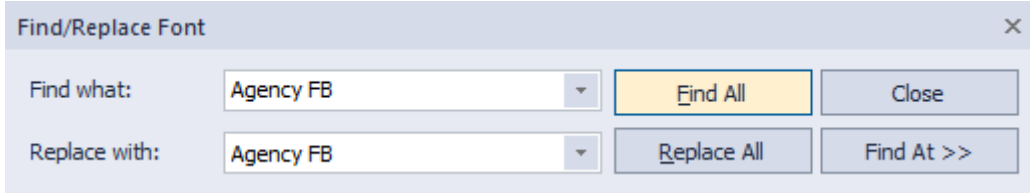

- 2 In the **Find** field, choose a font from the dropdown menu. The entire project is selected by default.

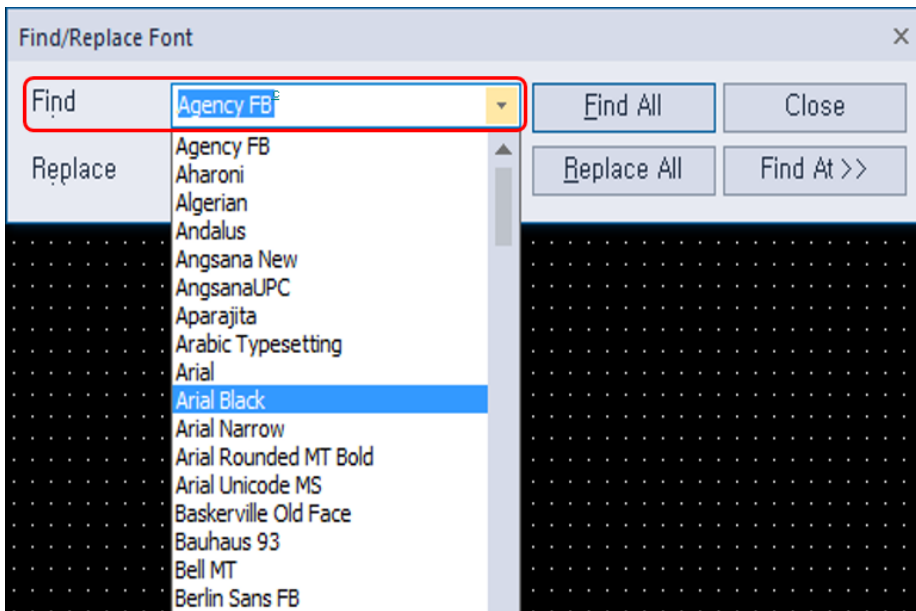

- 3 Select [Find All] to display the search results in the output window. Double-click the object to check to see the object.

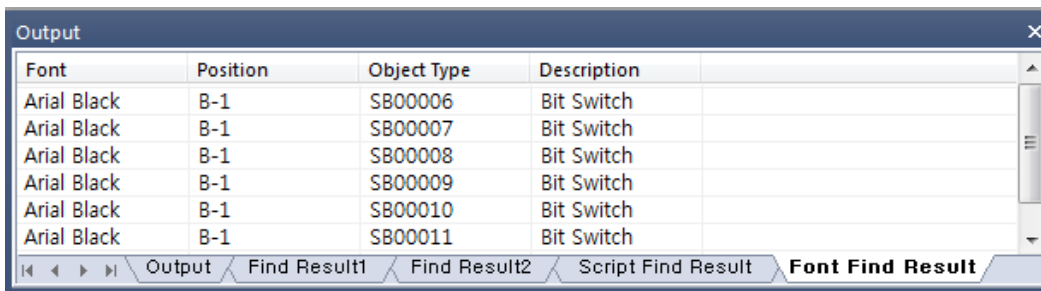

To replace all fonts in a range of addresses at once:

- 1 Click an object to select it, and then click [Tool] ► [Find/Replace All] ► [Font]. The Find/Replace Font window opens.

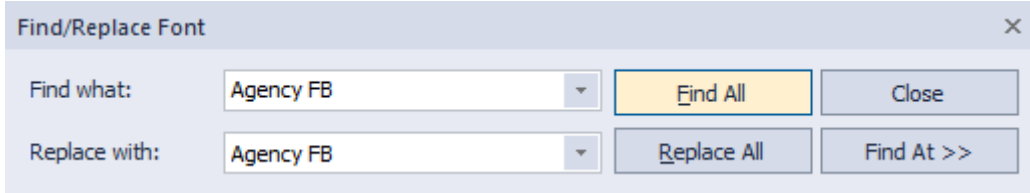

- 2 Choose the fonts from the dropdown menu for the **Find** and **Replace with** fields.

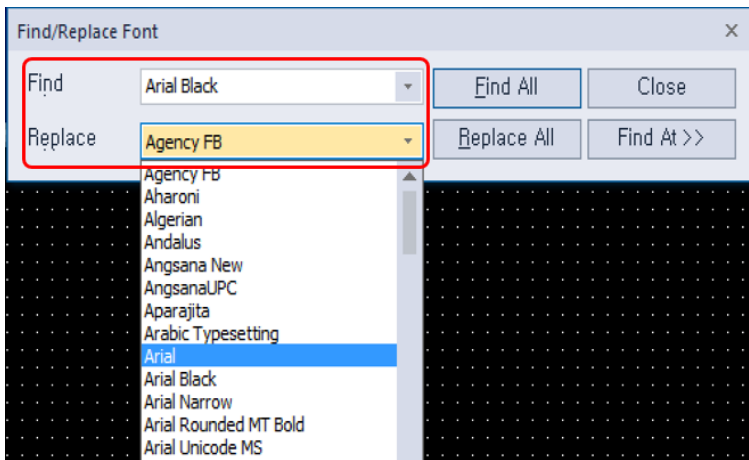

- 3 Click [Replace All].
- 4 Click [Yes] to confirm the address replacement. The output window shows the number of the replaced addresses.

2.6.6.4 Finding & Replacing All Strings.

Find strings:

- 1 From the menu, select [Tools] ► [Find / Replace All] ► [Strings].

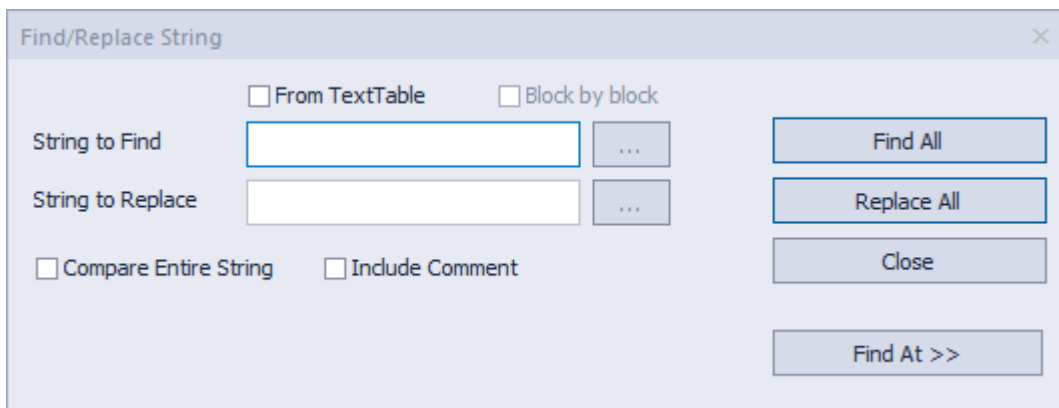

- 2 Select the string you want to find. If no objects are selected by default, they are found in the entire project. By default, it looks for the string that contains the string you are looking for, not including comments.

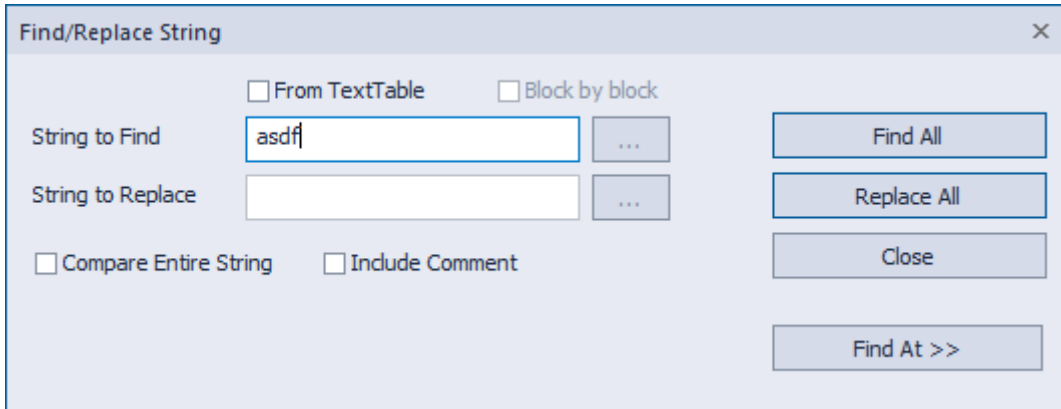

- 3 Select [Find All] to display the search results in the output window. Double-click the object to check to see the object.

The screenshot shows an "Output" window with a table of search results. The table has columns for Text, Text Table, Position, Object Type, and Description. The results are as follows:

Text	Text Table	Position	Object Type	Description
asdf		B-1	SB00001	Bit Switch Off ...
asdf		B-1	SB00001	Bit Switch On ...
asdf		B-1	SB00002	Bit Switch Off ...
asdf		B-1	SB00002	Bit Switch On ...
asdf		B-1	SB00003	Bit Switch Off ...

At the bottom of the window, there are several tabs: "Result1", "Find Result2", "Script Find Result", "Font Find Result", and "String Find Result". The "String Find Result" tab is currently selected and highlighted.

Replace All:

- 1 From the menu, select [Tools] ► [Find / Replace All] ► [Strings]. Enter the string to be replaced with the string to be found in the activated tool box.
- 2 Select [Replace All], all then select [Yes] in the message below to execute the replacement.

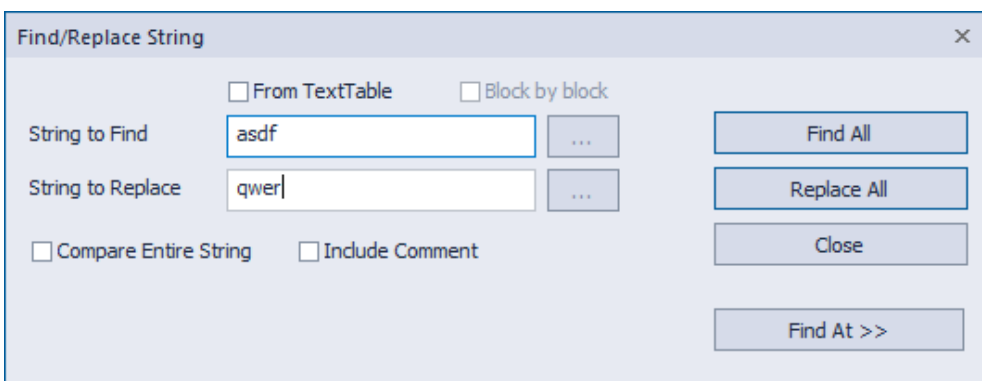

3 Select The number of changed strings is displayed in the output window.

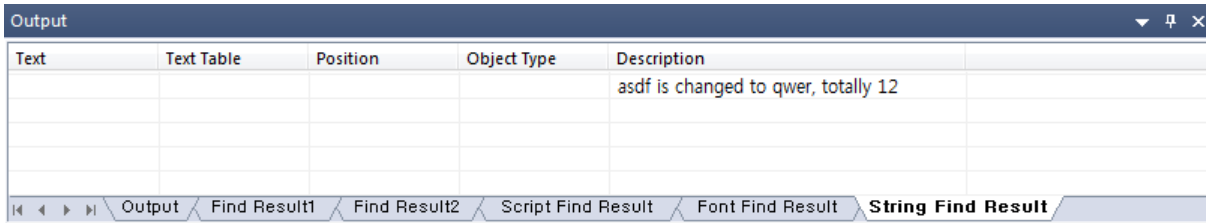

Note

If “From the text table” is checked in Find/Replace String, you can find or replace by text unit. If “Block by block” is checked, you can search or replace by string. For example, elements of the project that use “Text Table_01” as shown below can be changed while maintaining the number in the block as “Text Table_02”.

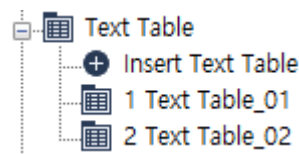

2.6.6.5 Finding and Replacing Devices, Fonts, and Tags from a List

To find and replace devices used in specific items in a project:

1 Click [Tool] ► [Find/Replace an item] ► [Device].

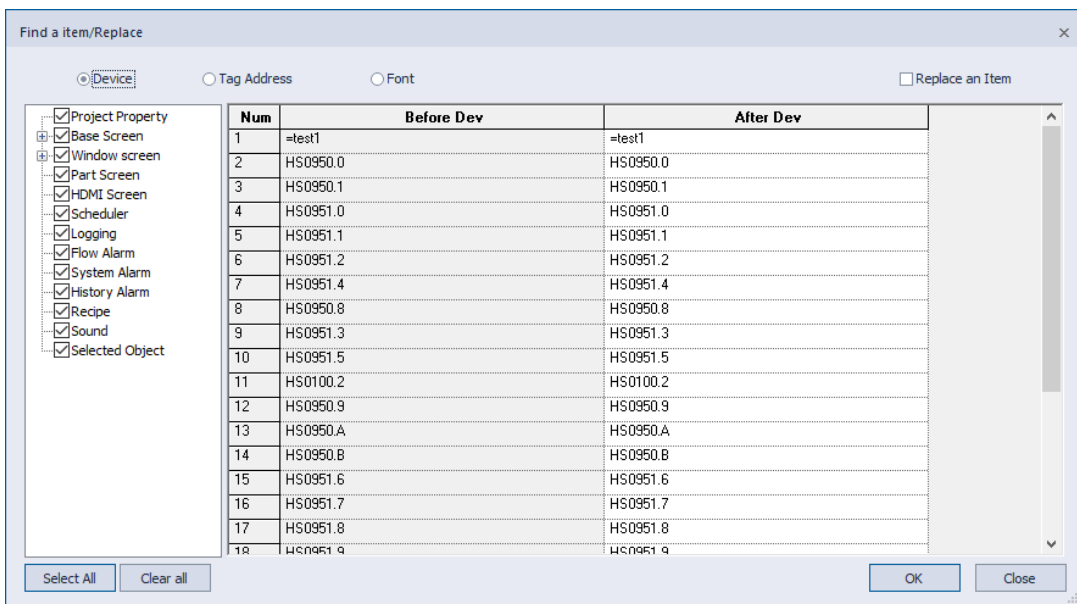

2 In the left pane, select the specific items in the project to search.

3 Find the devices in **Before Dev.** column, and click the value in **After Dev.** column.

Num	Before Dev.	After Dev.
1	HS0950.0	HS0950.0
2	HS0950.1	HS0950.1
3	HS0951.0	HS0951.0

4 Enter new value, or open a keypad by clicking  and input a value.

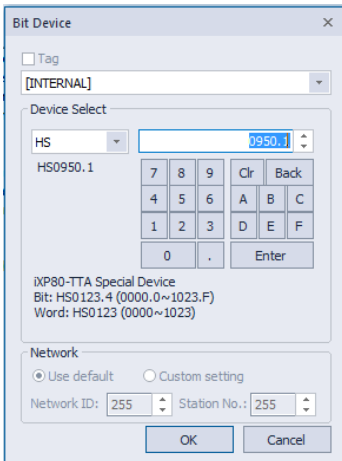

5 Repeat steps 3 and 4, and then click **Convert** when done.

Note

Check the **Selected Object** option to find device address from the objects you selected on the screen. If the selected object exists on the screen, "Selected object" is automatically checked in the search area.

- Project Property
- Base Screen
- Window screen
- Part Screen
- Schedule
- Logging
- Flow Alarm
- System Alarm
- History Alarm
- Recipe
- Sound
- Selected Object

If you check "From Text table" in Find/Replace String, you can search or replace in string unit. If you check the "Block by block" check box, you can change it by the page of the Text table page (block). For example, it is possible to change the elements of a project using "Text table_01" as shown below, keeping the number in block with "Text table_02".

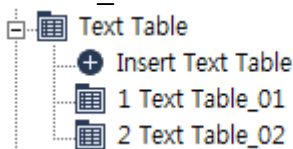

To find and replace fonts used in specific items in a project:

- 1 Click [Tool] ► [Find/Replace an item] ► [Font].

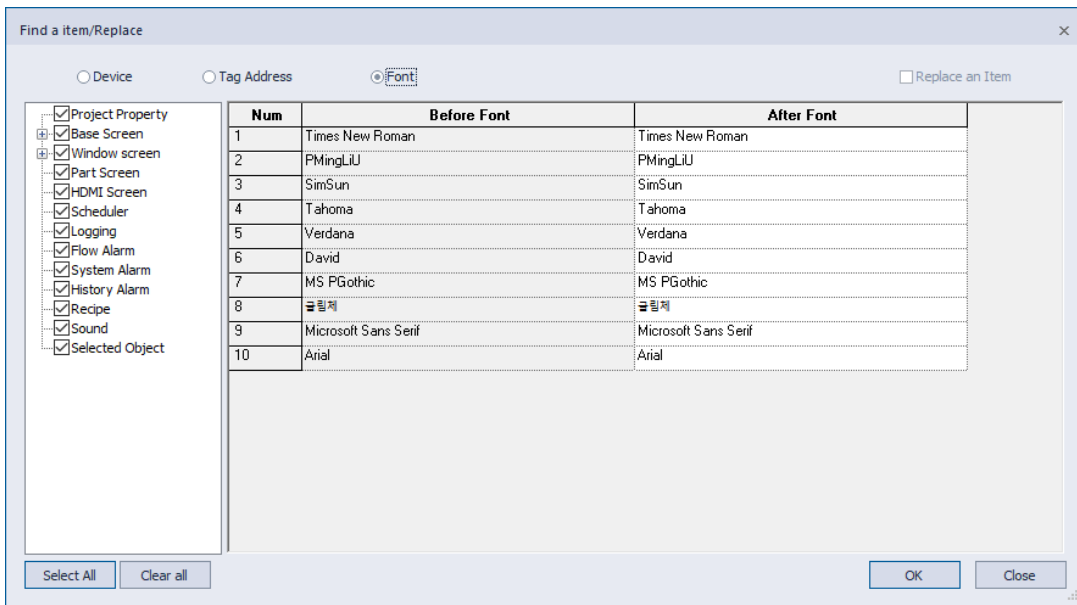

- 2 In the left pane, select the specific items in a project to search.
- 3 Find the font in **Before Dev.** column, and click the **After Dev.** column.
- 4 Select a new font from the dropdown list.

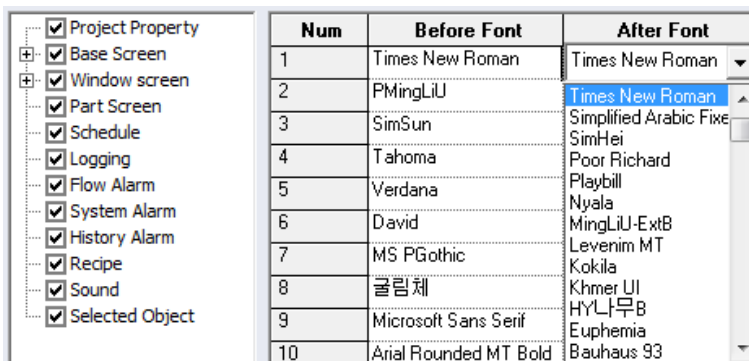

- 5 Repeat steps 3 and 4, and then click **Convert** when done.

To find and replace devices using a specific tag:

- 1 Click [Tool] ► [Find/Replace an item] ► [Tag address].

2. Project Development

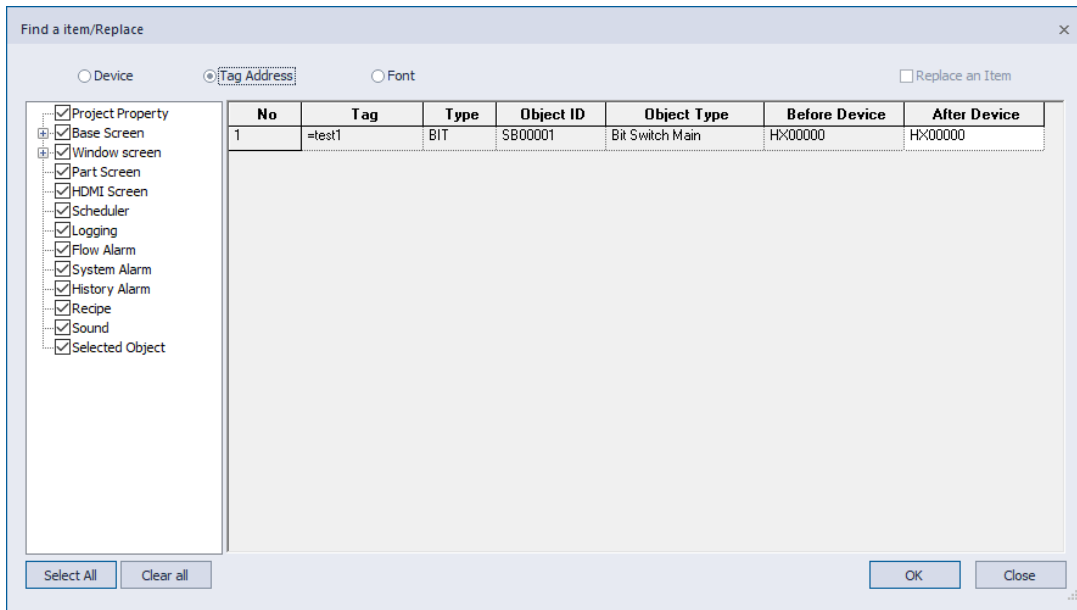

- 2 In the left pane, select the specific items in a project to search.
- 3 Select/Enter the “After Device.”
- 4 Enter a device address, or assign an address using the keypad to the right.

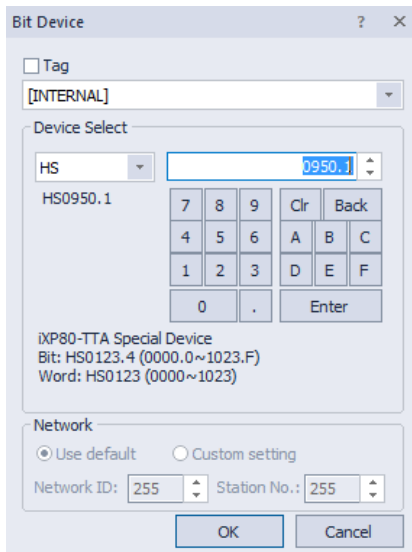

- 5 Click [OK] after entering the device address.

Note

- You can view and select individual objects that do not use tags. Unlike the “finding and replacing a device” feature (Click [Tool] ► [Find/Replace an item] ► [Device]) which replaces all the specific device address in the project at once, the “finding and replacing a device using a specific tag” feature allows for selective replacement .
- By dragging downward on the “After Device” column, you can fill the table with ascending device

numbers (from the first device address, each number becomes greater by 1). By dragging upward on the “After Device” row, you can fill the table with descending device numbers (from the last device address, each number becomes smaller by 1).

- You can click “Tag name”, “Before Device,” or “After Device” items on the title bar, to sort the table by ascending or descending order.
- You can double-click on the right edge of the title line items to adjust the cell size to fit the longest string in the row.

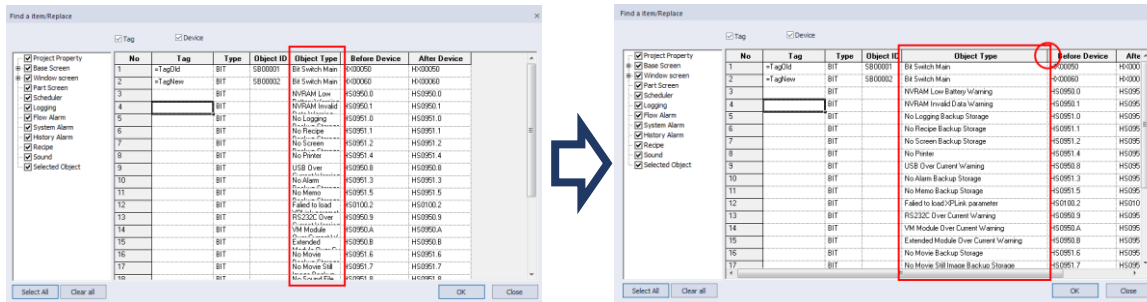

- You can click on the edge of a cell and drag to manually adjust the width and height of the cell.

2.6.6.6 Viewing Cross-References

You can view cross references to see device, tag, or script information for the entire project at once. To view device, tag, or script cross-references, click [Tool] ► [Cross Reference], and then select [Device], [Font], or [Script]. Device addresses, tag names, positions, object type, and descriptions are shown in the Output pane. You can double-click an entry in the cross reference to view device or script details.

Device Address	Tag Name	Position	Object Type	Description
P00002		B-1	SB00001	Bit Switch Main
P00124		B-1	LB00001	Bit Lamp Main
P0003		B-1	ND00001	Numeric Displ...
P00003		B-1	SB00002	Bit Switch Main
P00005		B-1	SB00003	Bit Switch Main
P00010		B-1	LB00002	Bit Lamp Main
HS0950.0		System Alarm		NVRAM Low ...

2.6.6.7 Viewing Cross-References

By using Cross Reference in Active screen, you can check the entire information of devices, tags, scripts, etc. used on the screen at once. To use on-screen cross-references, select [Tools] ► [Cross Reference in Active screen] from the toolbar menu, and then select [Device], [Font], or [Script]. The device address, tag name, location, object type, and description are displayed in the output window. Double-clicking on a specific row activates the object with that address in the screen.

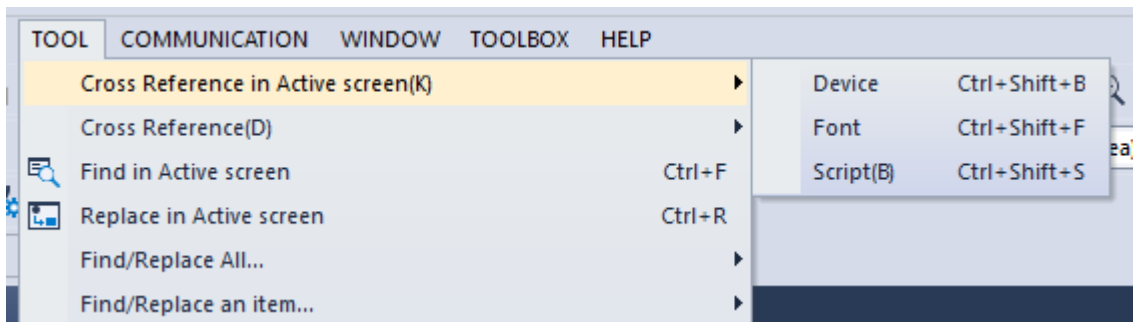

2.6.7 Switching Project Screens

To switch project screens conveniently, you can use the Next/Previous function. This allows you to scroll through screens in order. To switch project screens, click [Tool] ► [Previous Screen/Next Screen]. You can also click the Next ► or Previous ◀ icons on the toolbar.

2.7 Running XP-Simulators with other PLC Simulators

Before downloading a file edited using XP-Builder for XGT Panel, it can be simulated on a PC. The ladder program from another PLC simulator can be used to prepare device values for the XP-Simulator. In other words, the ladder program edited by another PLC program can be run in XP-Simulator to link the PLC simulator values and XP-Builder simulator values. This feature is supported on AB, Siemens, LS ELECTRIC, and Mitsubishi PLC simulators only.

2.7.1 XG5000 Simulator and XP Simulator

Before checking the XG5000 simulator, confirm that a supported version of software is used. The program may terminate abnormally if the specified version is not used.

- 1 Run the XG5000 software and edit the ladder diagram.
- 2 Run the XG5000 simulator.

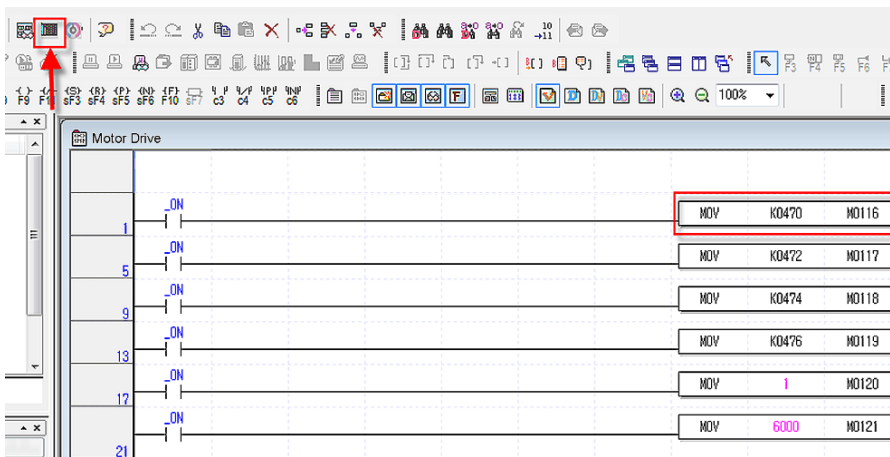

- 3 Edit the data to run in XGT Panel using the XP-Builder editor.
- 4 In XP Builder, check the check box next to [Use PLC Simulator] in [Common] ► [Project Property Setting] ► [XGT Panel Setting].

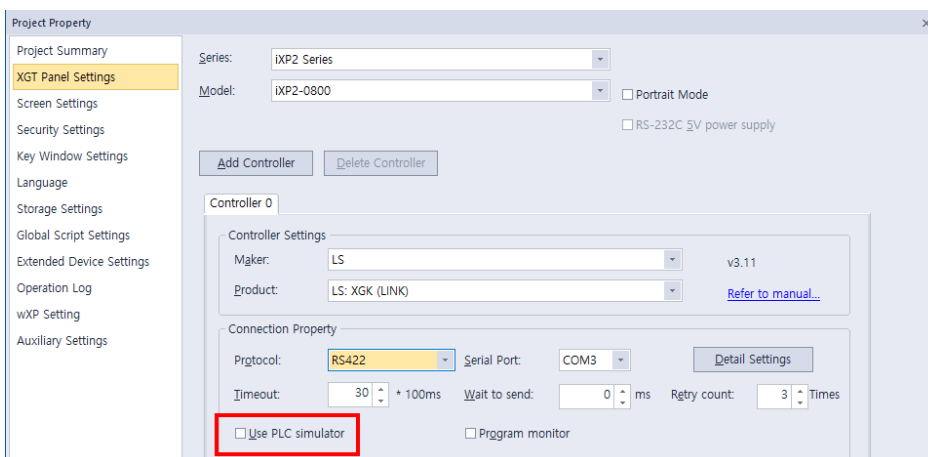

- 5 Run the simulator in XP-Builder.

- 6 Operate or change the device values either in XG5000 or XP-Builder simulator and monitor the operation.

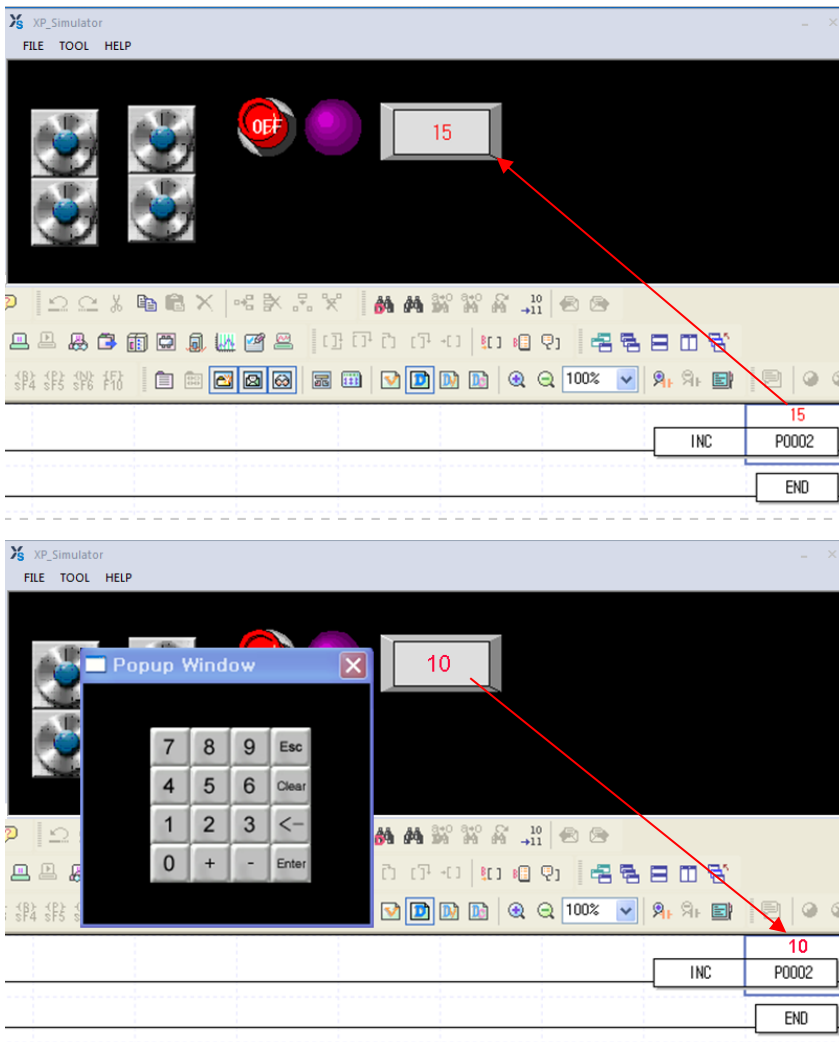

Note

- XP-Builder does not support multiple instances of the simulator. Only one simulator can be run at a time.
- Run the XG5000 simulator first, and then run the XP-Builder simulator.
- During simulation, the PLC type setting affects the operation.

2.7.2 S7-PLCSIM Simulator and XP-Simulator

Before checking the S7-PLCSIM simulator, confirm that a supported version of the software is used. The program may terminate abnormally if the specified version is not used.

- 1 Run [S7-PLCSIM]
- 2 Edit data to run in XGT Panel using the XP-Builder editor.
- 3 In XP Builder, select [Use PLC Simulator] in [Common] ► [Project Property Setting] ► [XGT Panel Setting].
- 4 If a device value is changed in S7-PLCSIM, the changed value is saved and displayed on the XP-Simulator.

Note

- S7-PLCSIM Version 5.4 or later
- PLC Driver Device Addresses Supported by S7-PLCSIM.
 - Data Block Devices
 - Flag Devices, Internal Memory
 - Output Devices (QI, QW, etc.)
 - Input Devices (I, IW, etc.)
- PLC Driver inaccessible Device Addresses Supported by S7-PLCSIM.
 - Timer Device (TW, etc.)
 - Counter Device (CW, etc.)
- If an input device is used in an object as a read device, the object will not be displayed correctly. Also, writing a value to a read device may result in abnormal operation.
 - A bit switch object uses an input device. Reversal of the device value cannot be applied with a bit switch, because the device value cannot be read.
 - For On/Off operation at a bit switch, only the selected bit works while other bits are reset.
- The PPI MD device is a 32-bit device. It can be interfaced with the PLC simulator in 32 bits. It is recommended to use the 32-bit version.
- The DB block can be normally interfaced to the XP-Simulator after it is set in SIMATIC Manager, downloaded to the PLC simulator, and then can be run properly in the PLC simulator. It will not work properly if it is not downloaded to the simulator even if it is added in SIMATIC Manager.
 - Input the name and type in SIMATIC Manager as shown in the screenshot below.

Address	Name	Type	Initial value	Comment
0.0		STRUCT		
+0.0	DB_VAR	INT	0	Temporary placeholder variable
+2.0	DB_VAR1	INT	0	
+4.0	DB_VAR2	INT	0	
+6.0	DB_VAR3	INT	0	
+8.0	DB_VAR4	INT	0	
= 0.0		END_STRUCT		

Perform copy & paste

DBW address (i.e., DBW0000, DBW0002, DBW0004...DBW0008)

- Download the added DB to the simulator.

2. Project Development

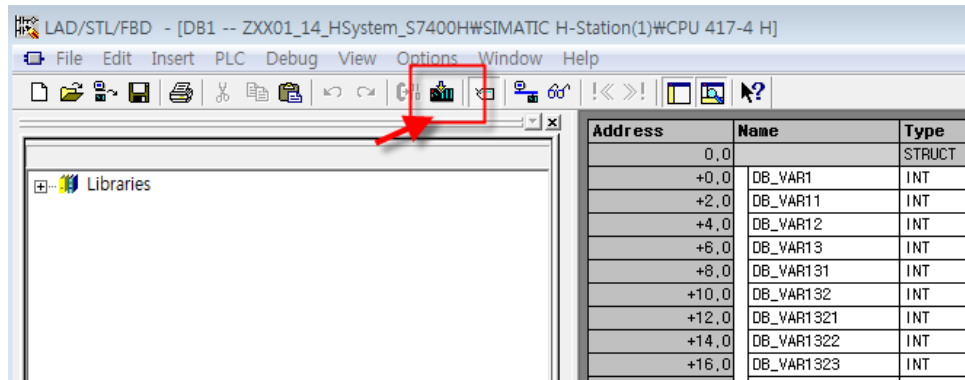

2.7.3 RSLogix Emulator and XP-Simulator

Before checking the RSLogix emulator, confirm that the program used is the RSLinx Classic version and that it supports the OPC server function. The program may terminate abnormally if the specified version is not used. The settings are described in the following procedure.

Configuring RS Logix5000:

1 Create the project.

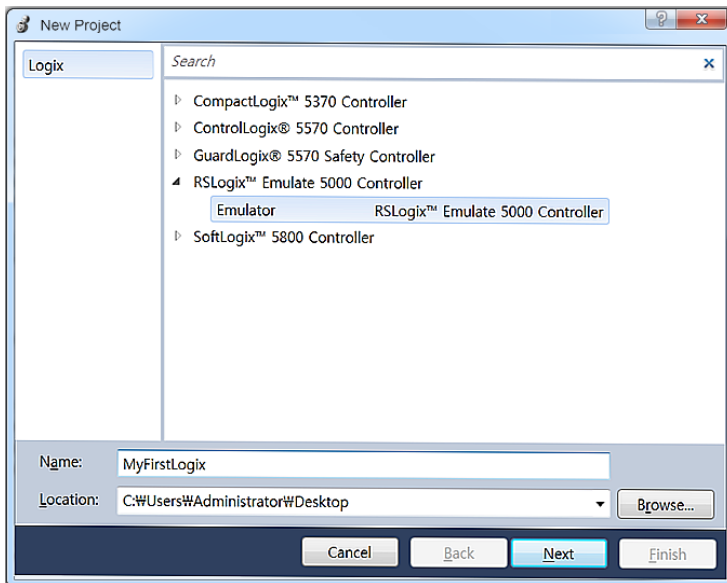

2 Set the slot number to be used by the emulator.

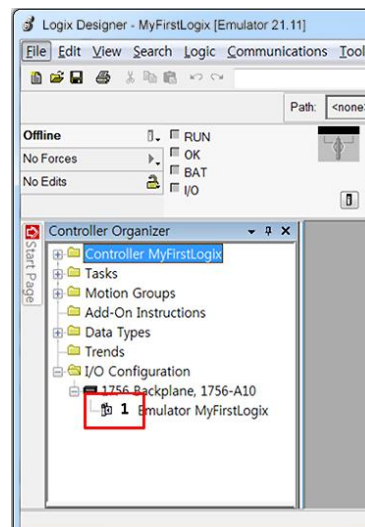
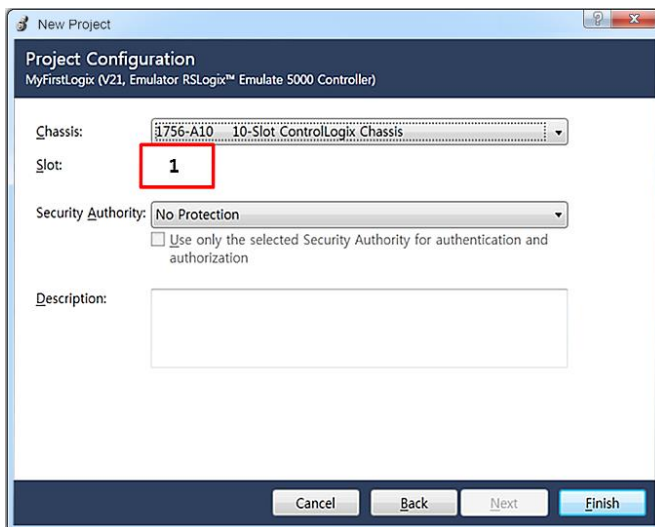

3 Select [New Module], as shown in the following screenshot, to set the I/O Configuration.

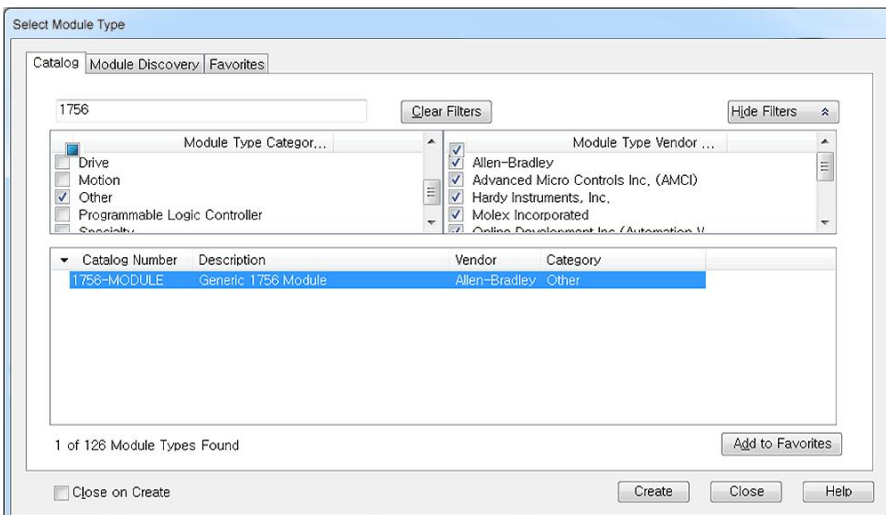
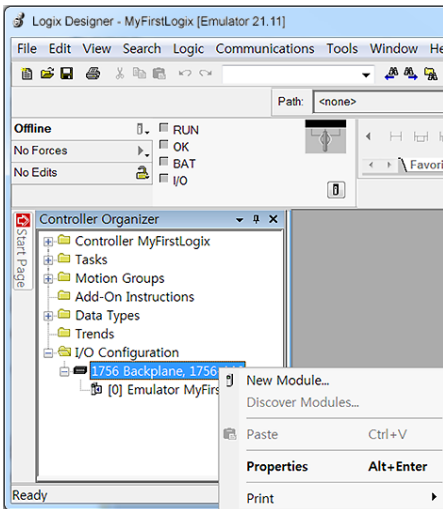

4 Set the Assembly Instance for the New Module to “2,” “1,” and “16.”

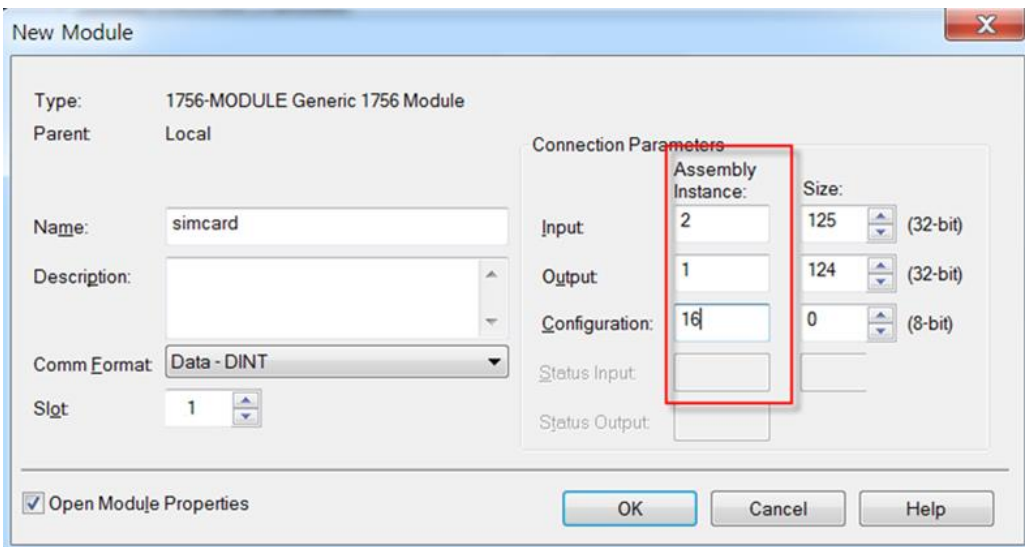

Configuring RS Emulator:

- 1 Right-click on the slot ("slot 1" in the example above) identified if the emulator was created in RS Logix.
- 2 Select the slot's Module Type as "Emulate5000 Controller" as shown in the figure below. Then, check the slot number.

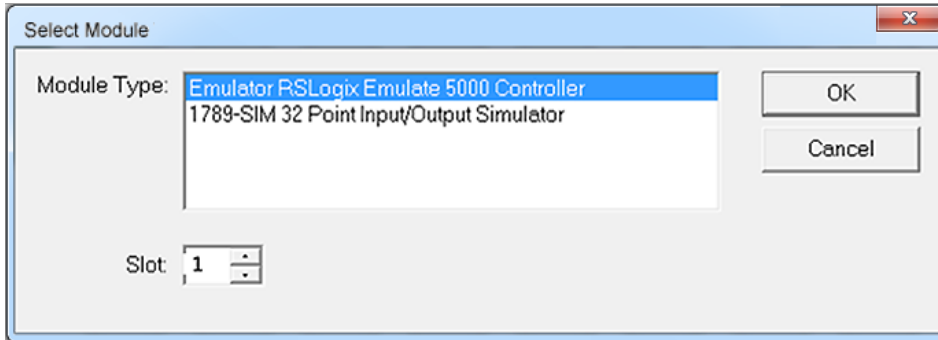

- 3 For other parameters, use the default values provided by the Tools.
- 4 Create the I/O Configuration slot in the same way. Right-click on the second slot in the list to create a slot. Then, specify the Module Type as 1789-SIM 32 Point Input/output Simulator.
- 5 The following details are displayed when the emulator settings are completed.

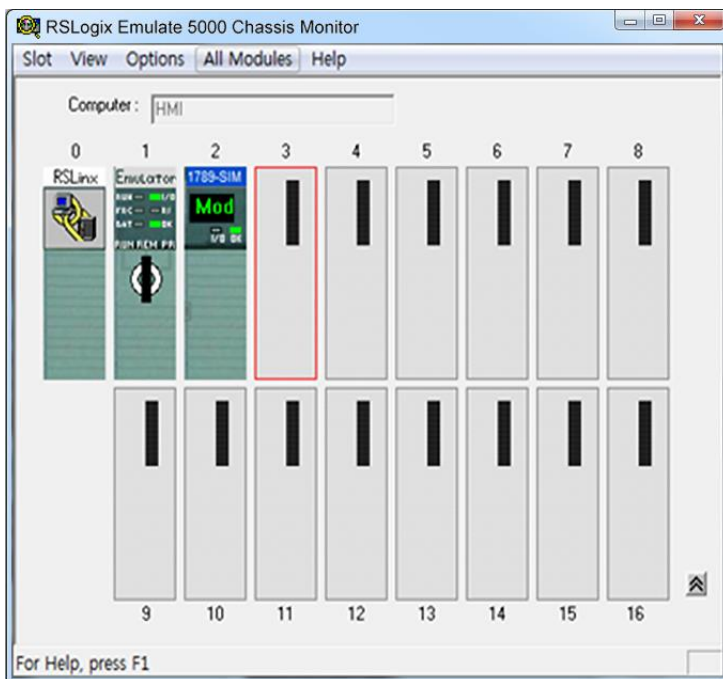

Configuring RSLink:

1 Select [RSLinx Classic Gateway] ► [Communications] ► [Configure Drivers].

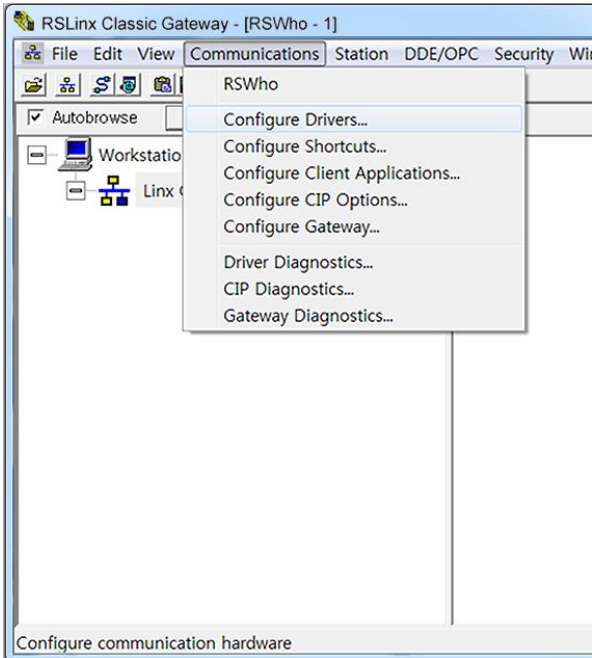

2 Select **Virtual Backplane** from the dropdown list.

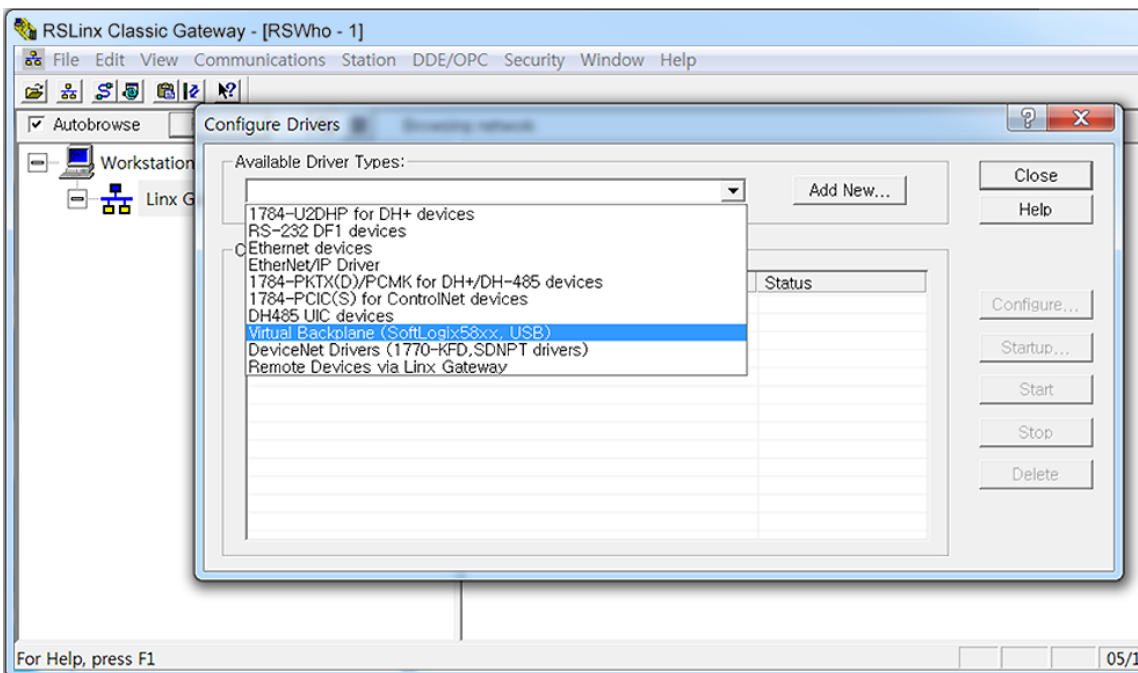

3 Select [RSLinx Classic Gateway] ► [DDE/OPC] ► [Topic Configuration]. The name of the project created in RS Logix 5000 is displayed in a list to the right of the window. Select the project and specify the topic in the left pane. Click [Apply] and then click [Done].

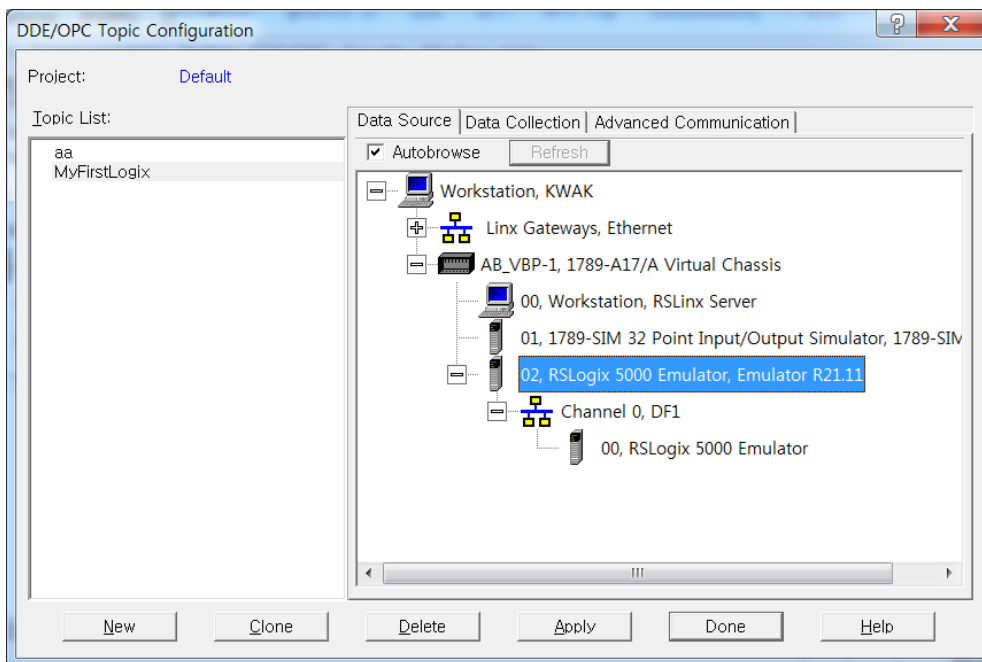

Running RS Emulator:

- 1 After the previous procedure is finished, run the emulator in RSLogix500. Select [RSLogix5000] ► [Communication] ► [Who Active] to run it.
- 2 Select the emulator in the Who Active window, as shown in the screenshot below, and click [Download].

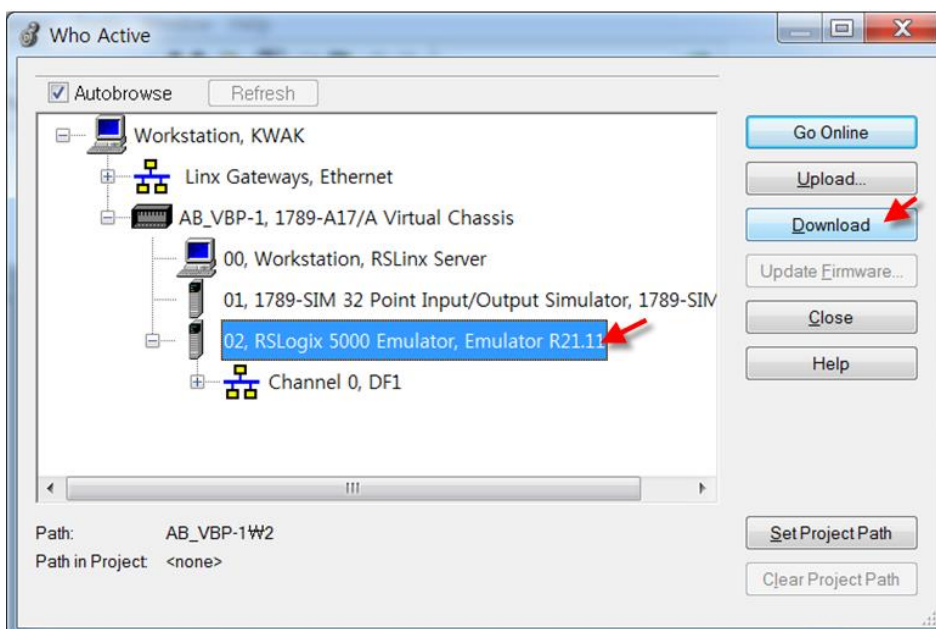

- 3 Execute Run Mode when these steps have been completed.

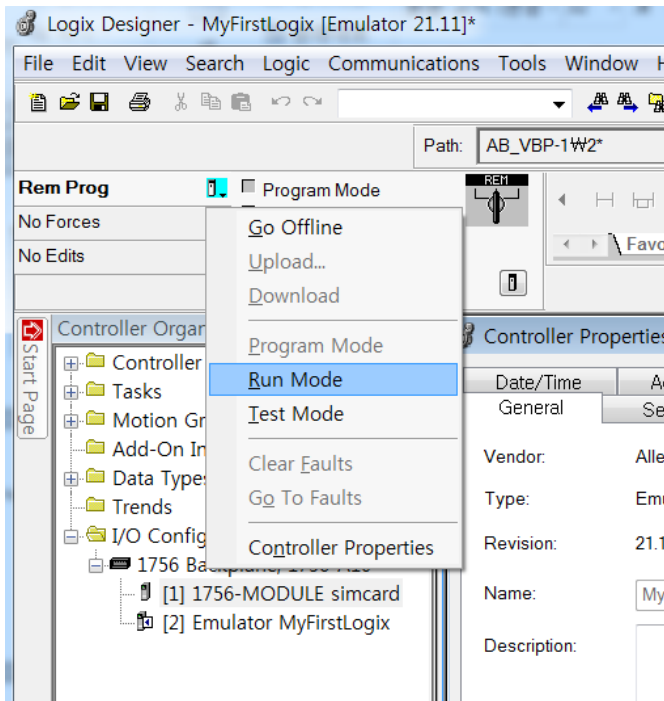

- 4 Register the tag in [RSLogix5000] ► [Logic] ► [Monitor Tags].
- 5 Edit the data to run in XGT Panel with the XP-Builder editor.
- 6 Select [Use PLC simulator] in [Common] ► [Project Property Setting] ► [XGT panel Setting] on the XP-Builder.
- 7 When the XP-Simulator runs, the list of projects created by RSLogix5000 is displayed as shown in the screenshot below. Select the project for the topic that was set in the procedure above.

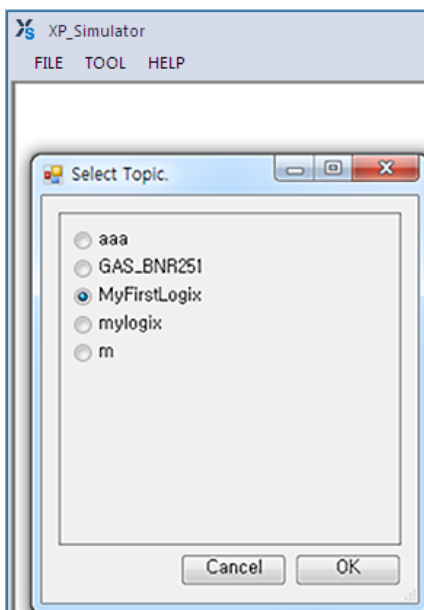

- 8 If the variables for PIC_101_SPProg are changed in RSLogix5000, as shown in the screenshot below, the target device value will be displayed in XP-Simulator.

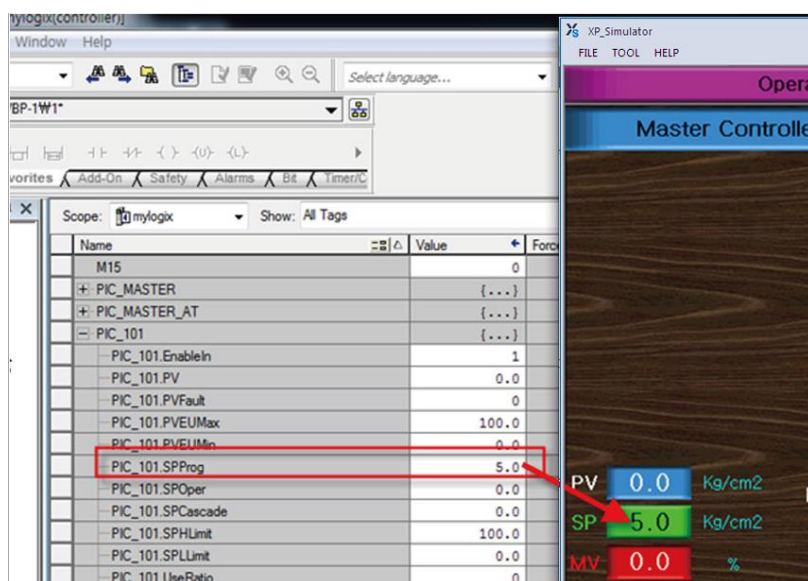

Note

All three tools must be set for the simulation in the data interface for the RSLogix emulator.

- RSLogix Emulate 5000 Classic Monitor 21.00.00 version or later.
- RSLinx Classic GateWay 3.51.00 or later (OEM and Single Node versions are not supported).
- Studio 5000 Logix Designer 21.00 version or later.

2.7.4 The GX Simulator and XP-Simulator

Before running the GX Developer or GX Works2 simulator, check the following items. The program may terminate abnormally if the specified version is not used.

- GX Simulator Version 7.30 or later
- GX Works 1.5 or later
- MX Component Version 3.08 or later

The procedure to configure a data interface for simulation between the GX Simulator and the XP-Simulator is detailed below.

1 Set the COM connection target to GX Simulator in [MX Component]–[Communication Setup Utility].

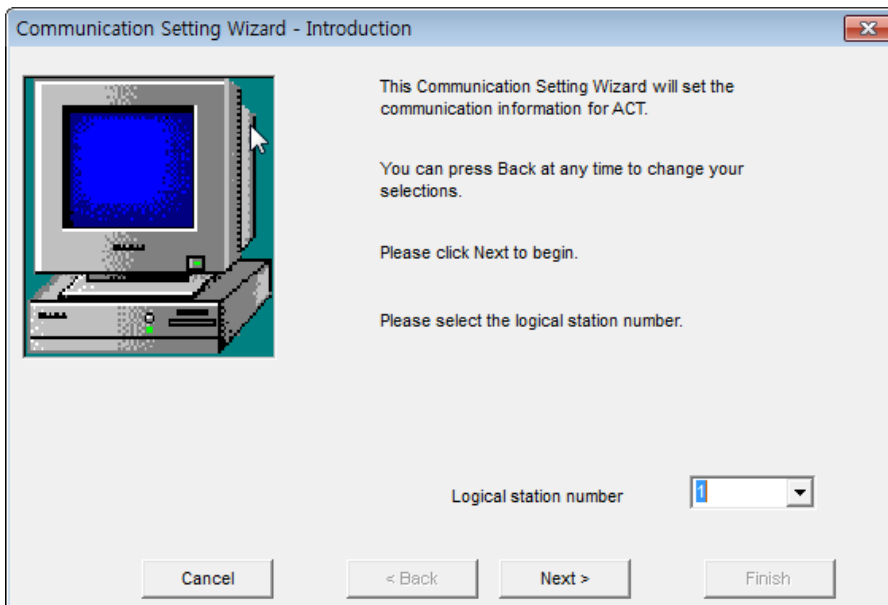
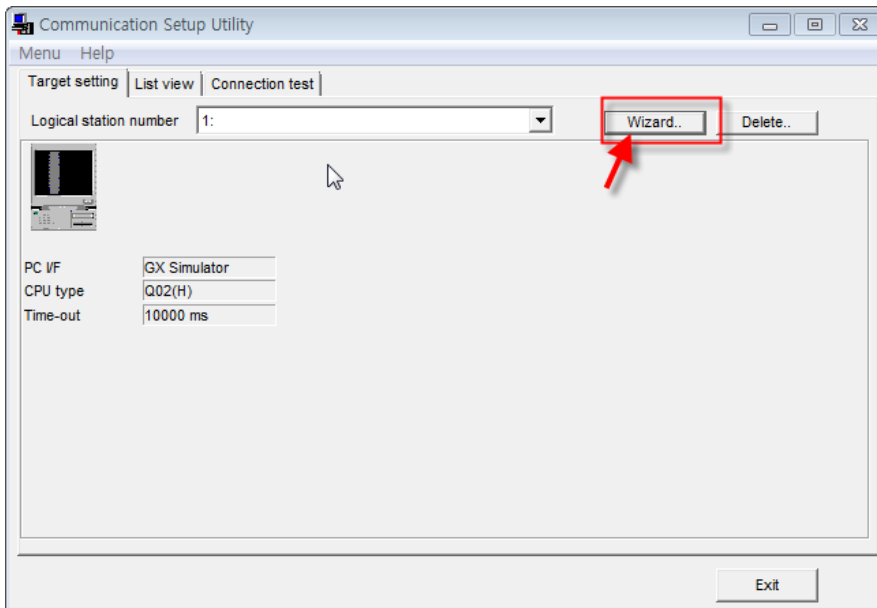

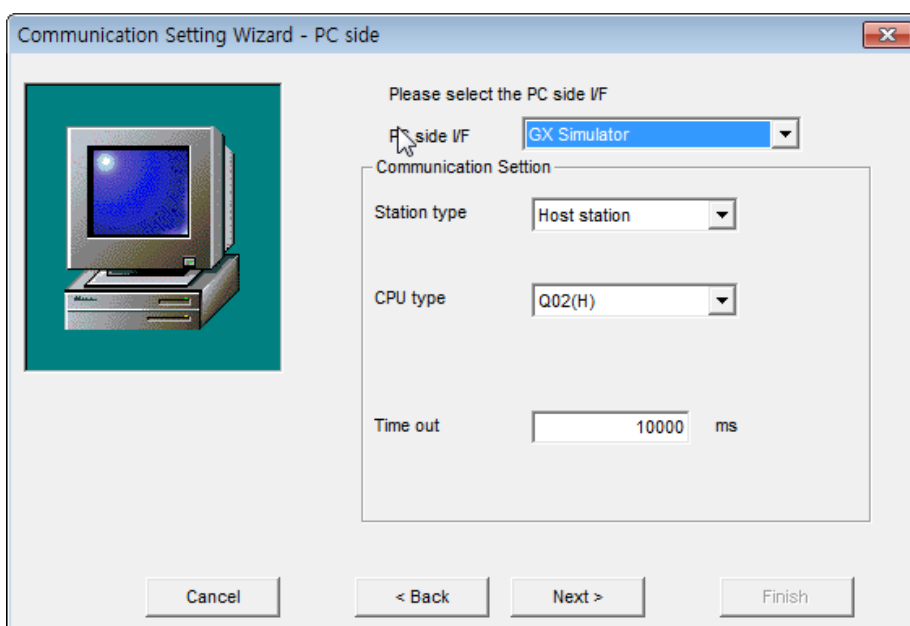

To connect with simulator running on GX Works2, you need to connect to GX Simulator2.

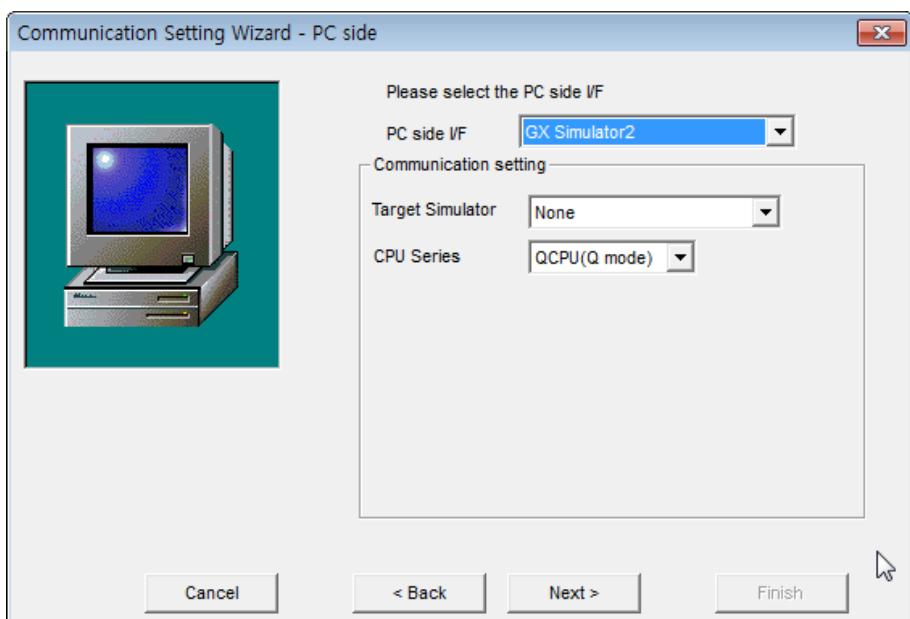

Item	Description
PC side I/F	Sets the COM Server target. Specify the GX Simulator as the target for the simulator.
CPU	Sets the CPU type for the simulator. The target CPU type for the ladder program edited in the GX Simulator is generally specified. Only the memory domain for a specified CPU type can be simulated. For example, if Q06H is specified in the Q02H CPU type or the GX Component Wizard, the GX Simulator can monitor only memory corresponding to the Q06H CPU.

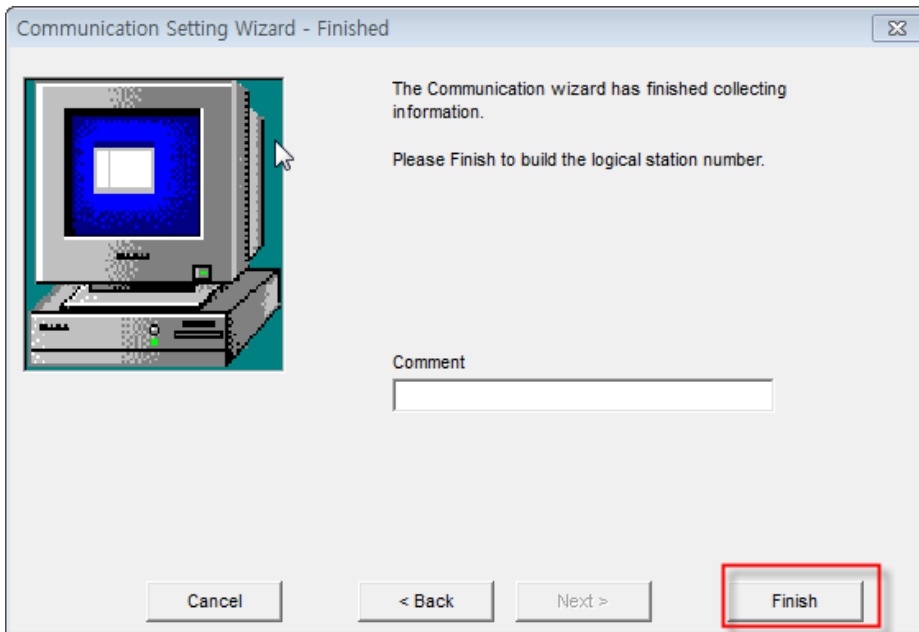

- 2 After the Communication Setup is completed in MX Component, create a ladder program using GX Developer.
- 3 After the ladder program is created, select [Tools] ► [Start ladder logic test] in GX Developer to run the simulator.
- 4 Edit the data to input into XGT Panel with the XP-Builder editor.
- 5 In XP-Builder, check the [Use PLC simulator] checkbox in [Common] ► [Project Property Setting].

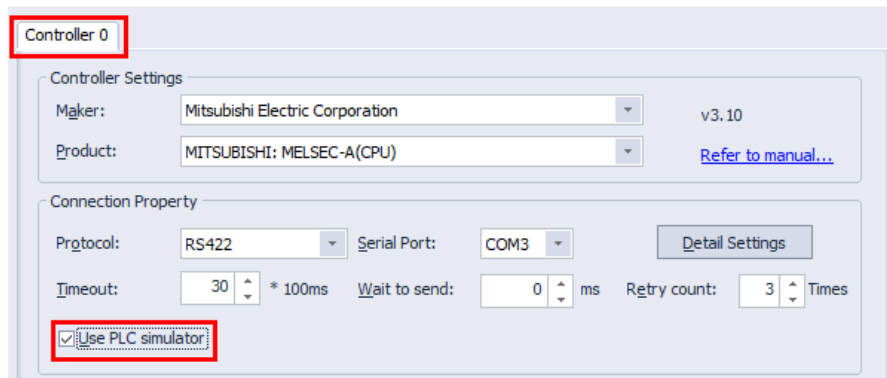

- 6 Run XP-Builder simulator. The CPU that is connected must be set when the GX Simulator and the XP-Simulator are connected. Set the CPU type that is same as GX Simulator's ladder program in the checkbox, as shown in the screenshot below.

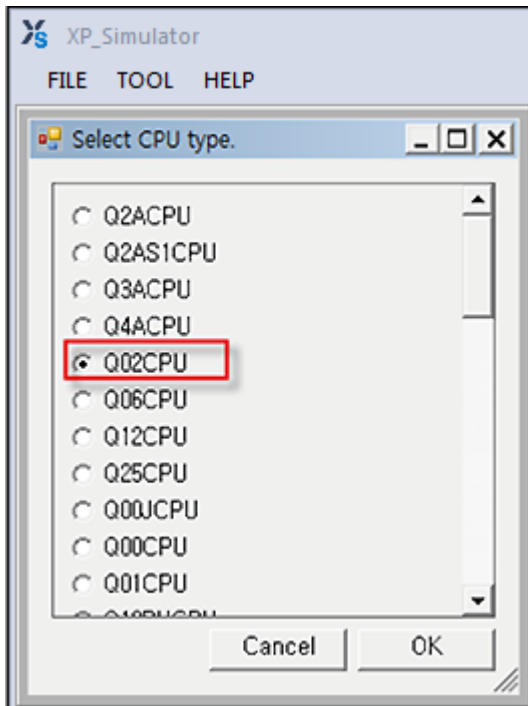

7 Set or modify the device value in XP-Simulator or GX Simulator.

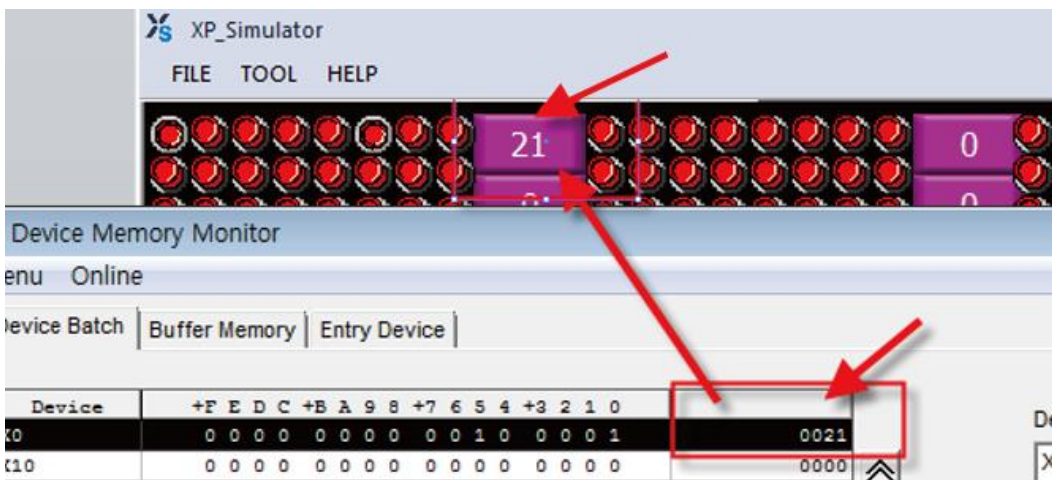

- If the X0 device value is set to 0x21 in GX Simulator, the same value will be displayed in the XP-Simulator.

Note

- Supported PLC Drivers
 1. SIEMENS Simulator Interfaces
 - Siemens: SIMATIC S7 300/400 Ethernet
 - Siemens: SIMATIC S7 3964(R)/RK512
 - Siemens: SIMATIC S7 MPI
 - Siemens: SIMATIC S7 PPI
 2. Rockwell Simulator Interfaces
 - Rockwell: EtherNet/IP ControlLogix/CompactLogix Series Native
 3. Mitsubishi Simulator Interfaces

- MITSUBISHI: MELSEC-A(LINK)
 - MITSUBISHI: MELSEC-FX(CPU)
 - MITSUBISHI: MELSEC-FX(ETHERNET)
 - MITSUBISHI: MELSEC-FX(LINK)
 - MITSUBISHI: MELSEC-Q(CPU)
 - MITSUBISHI: MELSEC-QnA, Q(ETHERNET)
 - MITSUBISHI: MELSEC-QnU CPU(ETHERNET)
 - MITSUBISHI: MELSEC-QnA, Q(LINK)
- XP-Simulator must be run only after another PLC simulator is run.
-

2.8 Managing a Project

Learn about project management functions, including transferring data to XGT Panels or removable memory devices, and receiving projects from HMI.

2.8.1 Transferring to an XGT Panel

The GUI you design in XP-Builder must be transferred to an XGT Panel. You can transfer the interface by using one of two methods: full transfer or modification transfer. By default, XP-Builder determines whether or not a previous version of the project exists on the XGT Panel and then transfers either the entire project or only modified parts of the project accordingly. However, you can force XP-Builder to transfer the full project, if desired.

Before transferring a project, you must select a connection method, as described in the following sections. There are three connection methods available: RS232C, USB, and Ethernet. The connection methods available will vary based on the XGT Panel model you are using.

To transfer a project:

- 1 Click [Communication] ► [Send] or select the download icon () from the toolbar.



2 Set the following options, as necessary.

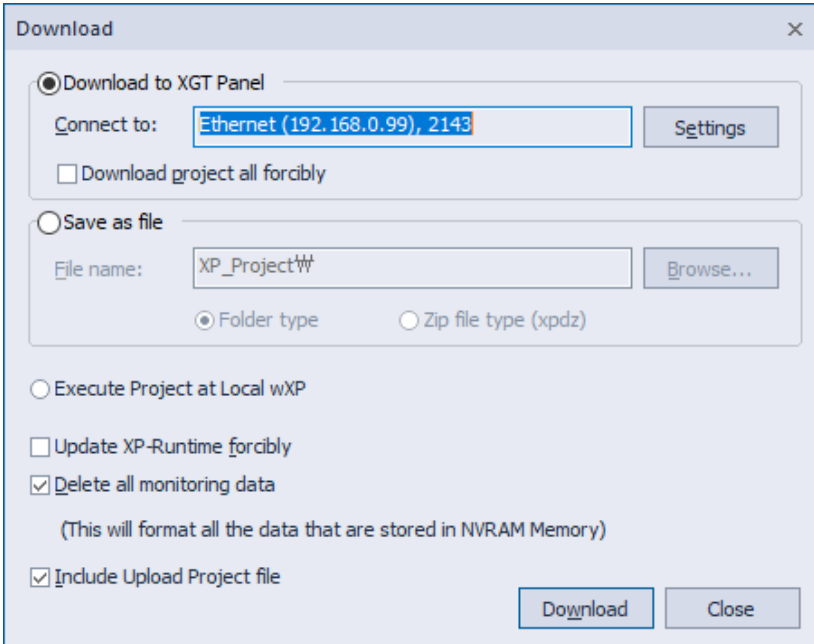

Function	Description
Download to XGT Panel	Select this option to transfer a project to an XGT Panel. This is the default option. Click [Settings] to change the communication settings.
Download Project All Forcibly	By default, XP-Builder determines if a previous version of the project exists on the panel and determines whether or not to transfer the full project or only to update data. However, you can select this option to force XP-Builder to transfer the entire project.
Save to Removable Device	Select this option to transfer a project to a removable memory device that is connected to your computer. For more details, refer to <2.8.2 Transferring to a removable Device> . This feature is not supported by the IPC series.
File Location	Displays the file path for a file that is saved in an external storage device. A folder type and a compressed file type can be selected. If the folder type is selected, multiple files to be downloaded to the input folder are generated. If a compressed file type is selected, multiple files are compressed and stored in a file that has a file name you specified. For file management purposes, the compressed file type is more convenient but it may take longer to compress the files. For example, files to be downloaded in the folder are saved to the G:\XP_Project\AAA folder. If a compressed file is used, files to be downloaded are saved as AAA.xpd file in

Function	Description
	the G: \XP_Project folder.
Update XP-Runtime Forcedly	By default, XP-Builder determines whether or not the runtime files need to be updated on the XGT Panel. However, you can select this option to force XP-Builder to update the runtime files on the panel. This feature is not supported by the IPC series. For the IPC series, you must run a setup file manually to update XP-Runtime.
Delete All Monitoring Data	Select this option to delete alarms, logging, recipe data, and operation logs stored in the NVRAM of the XGT Panel.
Include Upload Project File	Select this option to transfer a compressed project file to the XGT Panel in addition to the normal project files. This option is recommended when you do not have a project file on your computer and want to transfer it from the XGP Panel onto your computer. You can use a removable storage device to download a compressed project file.
Download	Click to transfer the data to the XGT Panel.

3 If necessary, click [Settings] to view or change the connection settings.

Function	Description
Connect Type	Set the connection type between your computer and the XGT Panel.
Details	You can specify the detailed connection settings for Ethernet, RS-232C, and USB connections. For the RS-232 connection, set the serial port and baud rate.

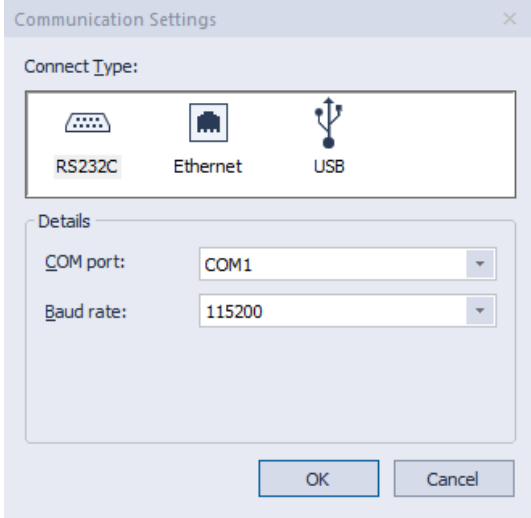
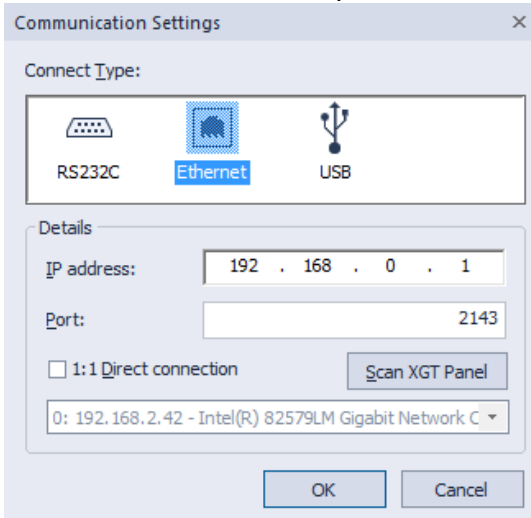
Function	Description
	 <p>For an Ethernet connection, set the IP address, port number, and network adapter.</p>  <ul style="list-style-type: none"> • In Windows XP, a virtual IP address is automatically created for an Ethernet connection. • In Windows 7, 8, 10 you must set the IP address manually for an Ethernet connection. <p>For a USB connection, set the XGT Panel type.</p>

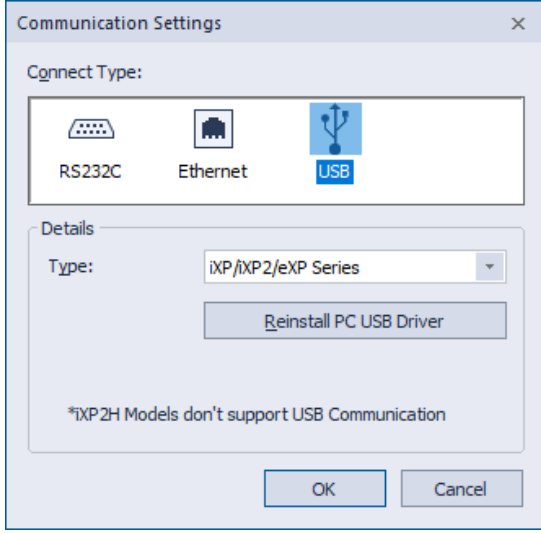
Function	Description
	
Scan XGT Panel	Click to scan for XGT Panels connected via Ethernet.

- 4 Verify that your computer and the XGT Panel are both properly connected via your chosen connection method, and then click [Download]

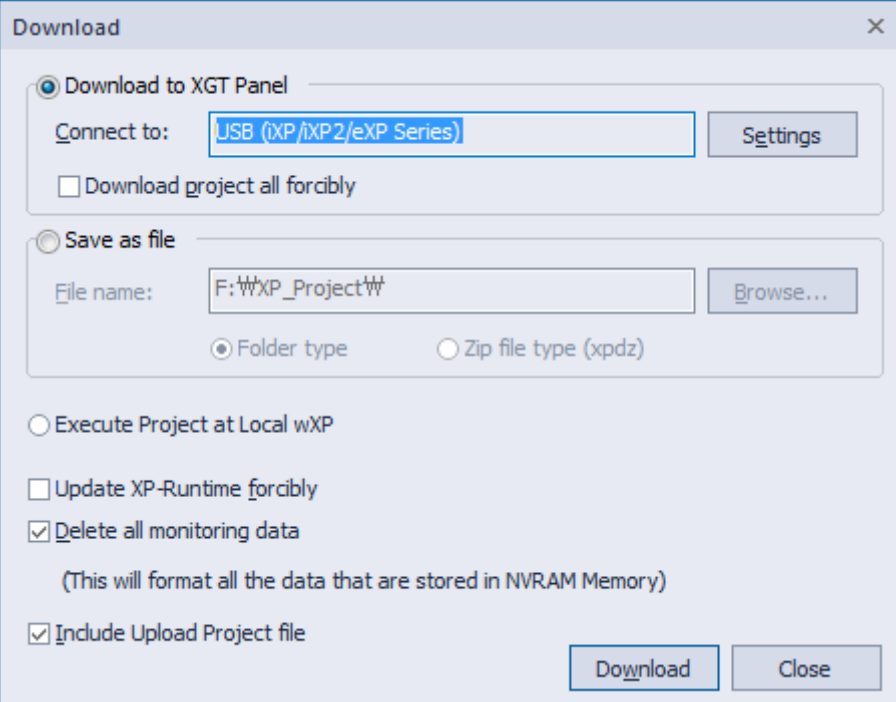

Note

- **Viewing Available Memory before Sending a Project**

View the available memory before sending the project file to ensure the file can be transferred successfully. You can compare Flash and USB/CF/SD memory capacities to the size of the project file before transferring it, as shown below.

Memory type	Case	Description
Flash memory	Downloading the whole project	Compare the project file size to the total memory available, because the memory will be erased prior to downloading the project.
	Downloading the revised parts only	Compare the project file size to the available memory.
USB/CF/SD memory	Compare the project file size to the available memory of an external device.	

- **Downloading the Entire Project**
You can download the entire project only when the entire memory on the external device is larger than or same as the size of the project file.
- **Downloading Only the Revised Parts of a Project**
- You can download a revised part of a project only when the size of the available memory on the external device is larger or same as the size of the project file.
 - If you attempt to transfer a project file when there is insufficient memory, the following pop-up window will appear. It shows the total memory capacity and the size of the project file.

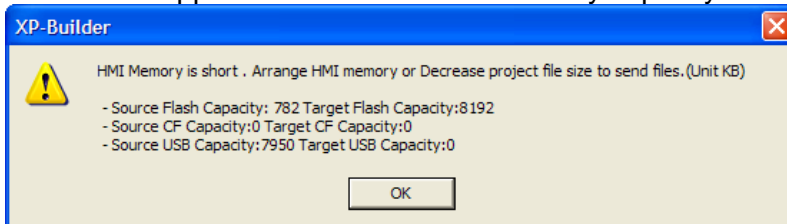

- If the available memory is insufficient to download only the revised part, download the entire project.

Note

- To set the password, in XP-Builder, click [Communication] ► [XGT Panel Information] ► [Password]. When you set the password for the first time, enter the new password again to confirm it. Your password can contain up to 10 characters in length.

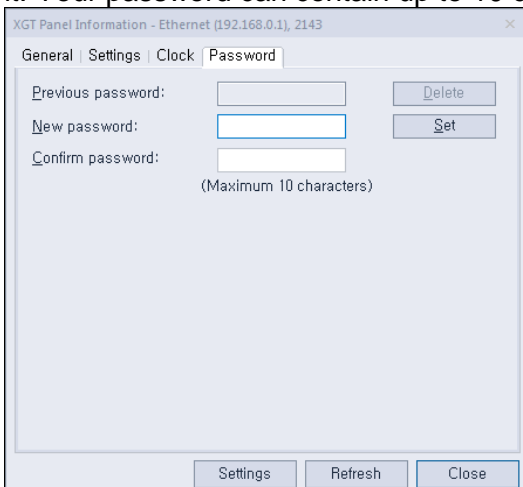

- XP-Builder transfers only the updated portion of a project, except in the following cases:

- You are transferring the project to the panel for the first time.
- You have changed the project properties, which can affect data throughout the entire project.
- The project ID has been deleted on the panel due to a communication error. Therefore, the project IDs cannot be compared between your computer and the panel.
- If the transfer is unsuccessful, it may be due to different runtime versions between XP-Builder and the XGT Panel. If the runtime version of the XP-Builder is later than that of the panel, update the runtime file on the panel to match XP-Builder and try the transfer again.

2.8.1.1 Using a Serial (RS-232C) Connection

A serial connection provides a 1:1 communication method between the control device and a computer. A 6-pin cable is required to make a serial connection, but this cable is not provided with the XGT Panel.

To use a serial connection:

- 1** Connect the serial cable to the TOOL port on the XGT Panel and RS-232C port on a computer.
- 2** On the XGT Panel, close any open programs.
- 3** Tap and hold the screen to open the menu.
- 4** Tap [Settings] ► [PC Conn Setting].
- 5** In **RS232 Baud Rate**, select a baud rate.

Note

Only XP series panels support connections via RS-232 ports. eXP/eXP2/iXP/iXP2/IPC series panels do not support it.

- 6** In XP-Builder, select [Communication] ► [Send] ► [Settings] ► [RS232C].

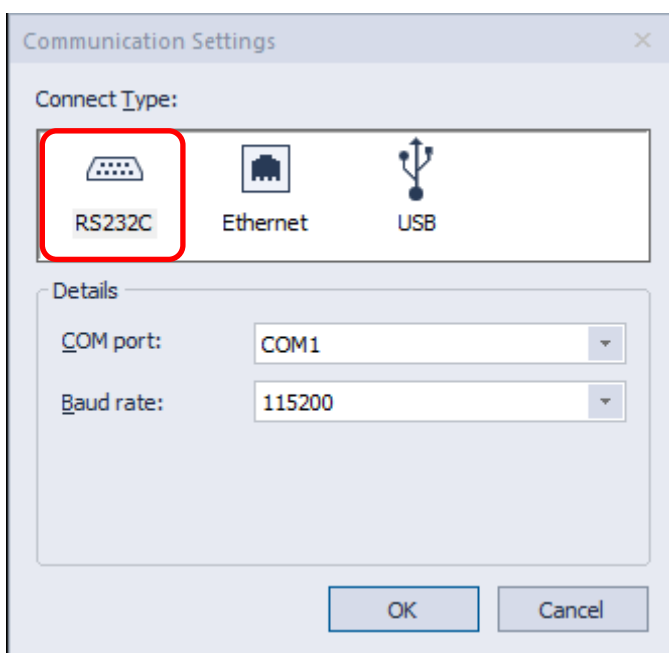

- 7 Select the same baud rate that you set on the XGT Panel. If the transfer rates do not match, the transfer will fail.

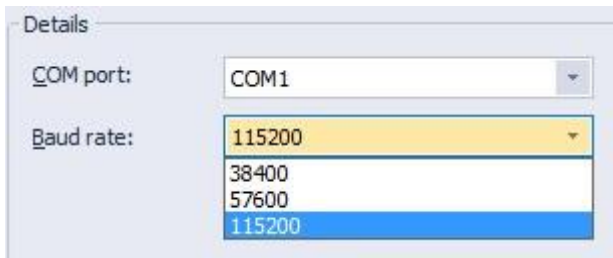

- 8 Select the serial port connected to the XGT Panel. The COM port number must be the same as the one used by your computer for the RS-232C connection. To set the COM port number on your computer, open the Control Panel, locate the Device Manager, and modify the Ports' (COM&LPT) settings.

2.8.1.2 Using an Ethernet Connection

An Ethernet connection is typically much faster than a serial connection; so using an Ethernet connection is highly recommended.

To use an Ethernet connection:

- 1 Connect a computer and an XGT Panel to a network via Ethernet cables. You can also use a cross cable connection if a network is unavailable. The IP addresses of the XGT Panel and the connected computer must be in the same Subnet mask.
- 2 On the XGT Panel, close any open programs.
- 3 Tap and hold the screen to open the menu.
- 4 Tap [Settings] ► [Ethernet Setting].
- 5 Set the Ethernet IP, Gateway, and Subnet mask.
- 6 Tap [Go to Main Menu].
- 7 In XP-Builder, click [Communication] ► [Send] ► [Settings] ► [Ethernet].

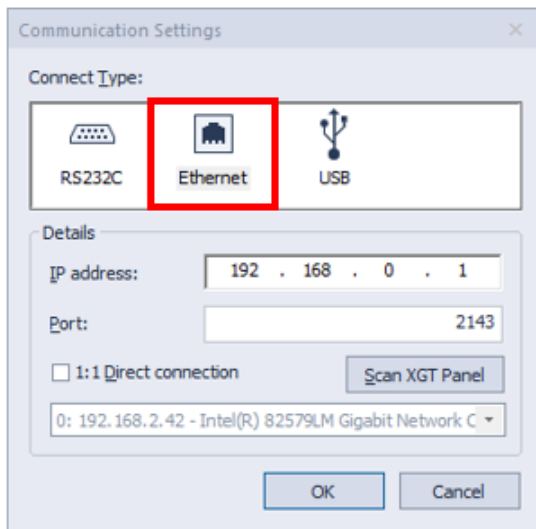

8 Set the IP address and port number to match the ones that are set in the panel.

Note

- You can use the automatic search function in XP-Builder (Scan XGT Panel) to locate and connect XGT Panels on a network. The feature uses the UDP protocol to retrieve information about the XGT Panel and returns it via broadcast messages to a default address (255.255.255.255). This search is performed only on the local network. If a gateway exists between the search computer and the XGT Panel, the message may be blocked.
- By default, the last address used will remain in the settings until you replace it manually or update it by performing a scan for connected XGT Panels.
- If you are transferring information to multiple XGT Panels, the data will be transferred in order by IP address. When you view IP addresses as shown in the following example, they appear in ascending order.
- The XGT series uses port 2143, and the IPC series uses port 2144. When downloading a project, port setting is not required because the port number is automatically selected based on the selected panel specifications.

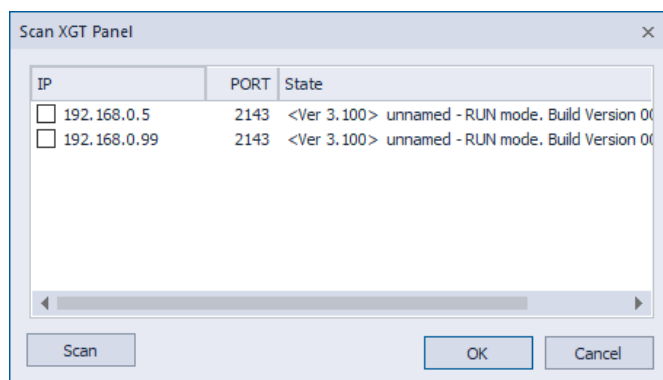

2.8.1.3 Using a USB Connection (XP models)

To use a USB connection, you must use an XPO-USBC cable, manufactured by LS ELECTRIC. The USB cable is not provided with the XGT Panel, so you must purchase one separately. A USB connection provides 1:1 communication between a computer and a panel.

Note

- The procedures described in this section apply only to XP series panels. Refer to **<2.8.1.4 Using a USB Connection (iXP/eXP/iXP2 models)>** for information on USB connections with iXP/eXP series panels.
- The USB connection is supported by XGT Panel operating software versions 1.24 and higher.

To use a USB connection:

- 1 Run XP-Builder, and then create and save the project to be transmitted.
- 2 Connect PC and XGT Panel by Ethernet or serial.
- 3 Click [Communication]-[XGT Panel Information], then go to the setting tab and click Install/Update XGT Panel USB driver to download USB driver to XGT Panel.



- 4 Connect the USB cable (XPO-USBC) to each port on the PC and XGT Panel. When USB cable is connected to the XGT Panel, the USB icon is displayed at the bottom-left corner.

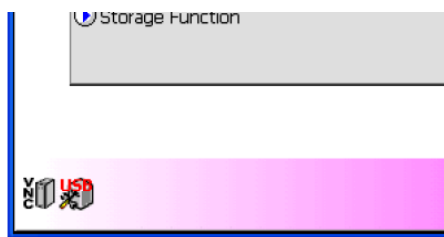

- 5 Click [COMMUNICATION] ► [Send] to open the Download screen.
- 6 Click [Settings] to open the Communication Settings screen.
- 7 Select the [USB] icon from the [Connection Type] selection list. Select **XP Series** as the type in the Details.

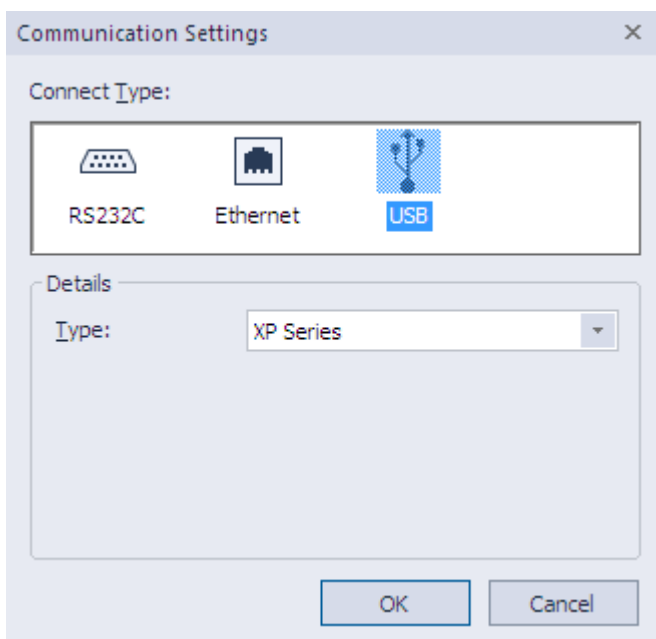
**Note**

- Once you initially download the XGT Panel USB driver installation/update, you can download via USB without installing a separate USB driver

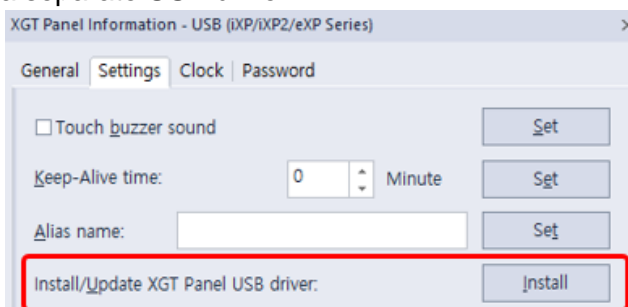

2.8.1.4 Using a USB Connection (iXP/eXP/iXP2/eXP2 models)

The mini-USB cable that supports USB 2.0 communication is available for iXP, iXP2, eXP, eXP2 Series. The cable configuration procedure is detailed below.

- 1 Run XP-Builder when the cables are properly connected and the XGT Panel settings are complete.
- 2 Create and save the project to be transmitted.
- 3 Click [COMMUNICATION] ► [Send] to open the Download screen.
- 4 Click [Settings] to open the Communication Settings screen.
- 5 Select the [USB] icon from the [Connect Type] selection list. Select **iXP/iXP2/eXP/eXP2 Series** as the type in the Details.

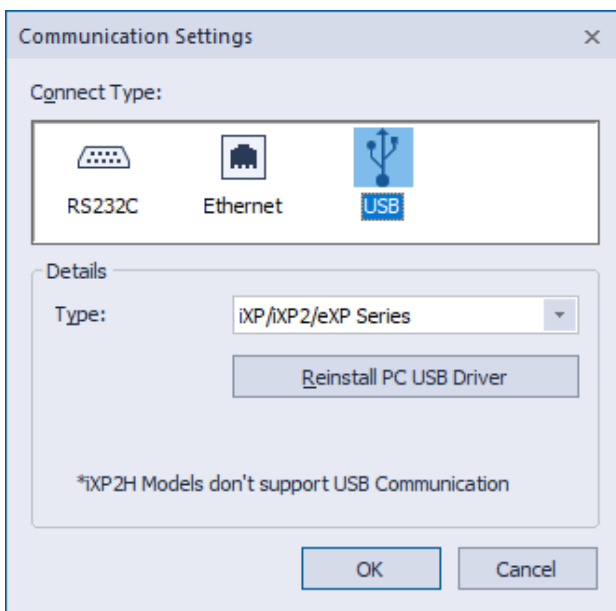

Note

- 1) The OTG cable connected to the XGT Panel must be USB 2.0 or higher
- 2) When installing XP-Builder, rNDIS driver is installed automatically, so there is no need to re-install the driver unless it was deleted intentionally.
- 3) Take the actions below if the following message appears.

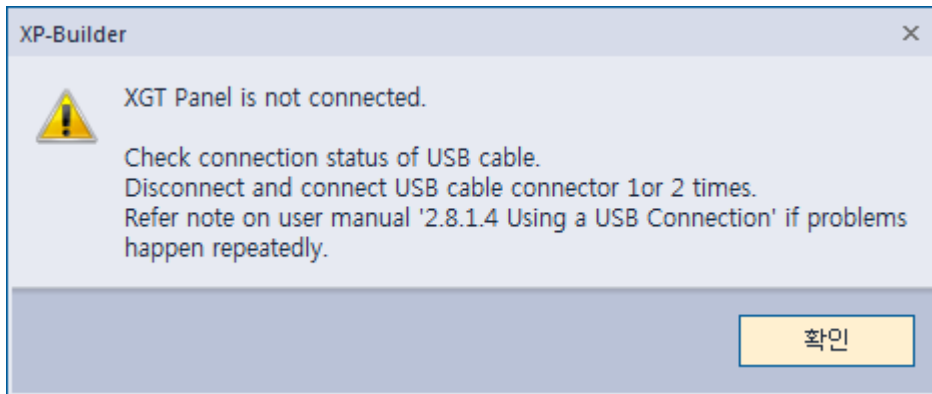

- A. Make sure that the cable between PC and HMI is connected properly.
- B. If there is no communication even after connection is established, unplug the USB cable and repeat 1 or 2 times.
- C. If you cannot communicate even after trying the solutions, press the [PC USB, Driver Reinstallation] button in [Communication] - [Transfer Settings]. Then install the RNDIS Driver and unplug the USB cable 1 or 2 times until the [Remote NDIS based Device] in [Device Manager] – [Network Adapter] is displayed properly.

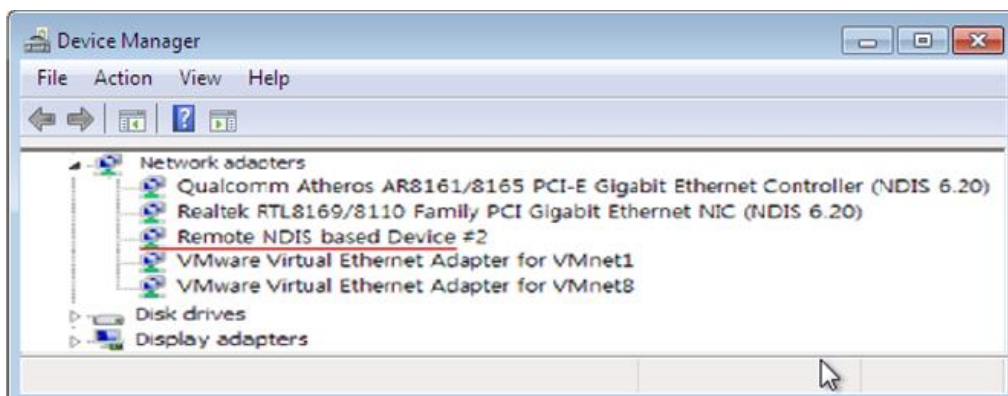
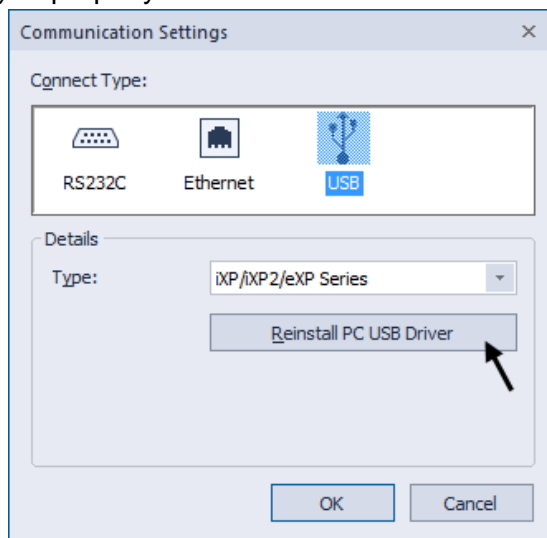

- D. If the driver does not load properly after installation, remove the USB cable from

the PC and HMI, reboot the PC, and reconnect the USB cable to see if the driver loads as above.

4) Take the actions below if the following message appears.

The rNDIS driver is normally loaded, or the rNDIS network adapter's IP setting is in progress or it is not set up properly.

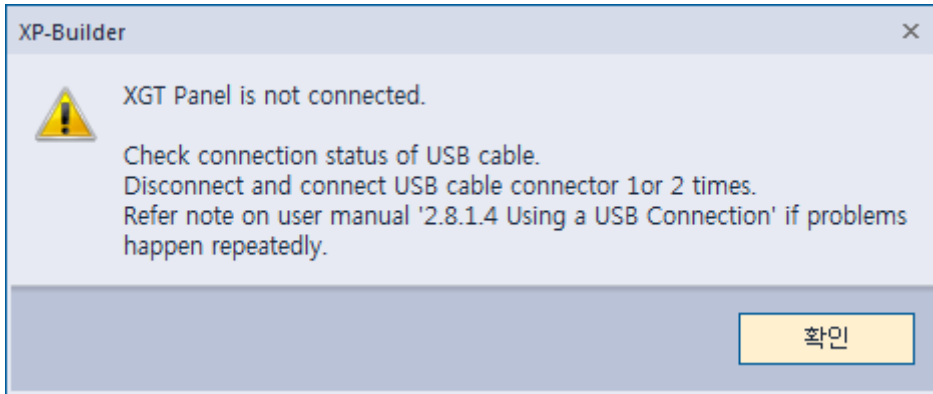

A. Wait for 1 ~ 2 minutes and try connecting again.

B. If the message appears even when connecting after standby, manually set the IP address to 184.114.58.254 in [Control Panel] - [Network and Internet] - [Network Connection] and retry communication.

2.8.2 Transferring to a Removable Device

For convenience, you can transfer the project to a removable drive and then connect the drive to an XGT Panel to update it.

To transfer the project to a removable drive:

1 Click [Communication] ► [Send] or select the download icon (📄) from the toolbar.

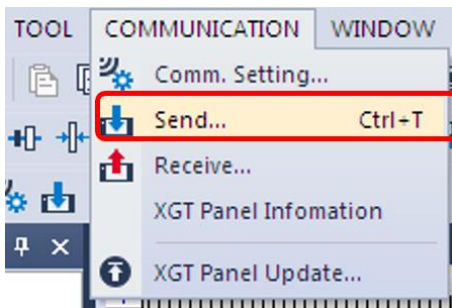

2 Check the checkbox next to **Save as file** and select the location of the removable device. By default, the project will be saved in the Drive name\XP_Project\Folder name folder, unless you specify a different folder name. To download the project file, you must create a folder inside the **XP_Project** folder. The folder will be created automatically.

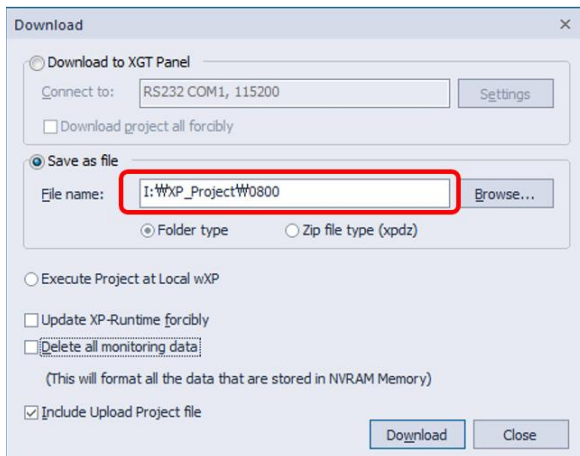

3 Click [Download].

Note

Ensure that your removable drive has sufficient space to store your selected project files. If the drive has insufficient space available, an error message will appear that describes the available memory and the total memory required to transfer the project files.

If there is no folder with the same name when saving as file in XP-Builder or as a storage device in the XGT Panel, the default path is “\XP_Project~”, which is case-sensitive and saved. Therefore, if there is already a lowercase letter “xp_project~” in the path to be saved, it is saved as the corresponding folder.

2.8.3 Starting a Project File from a Local wXP

Setup, Send, and a Start XP-Builder compatible version of wXP and send wXP projects written by XP-Builder.

Start project in local wXP

- 1 Click [Communication] ► [Send] or select the download icon () from the toolbar.

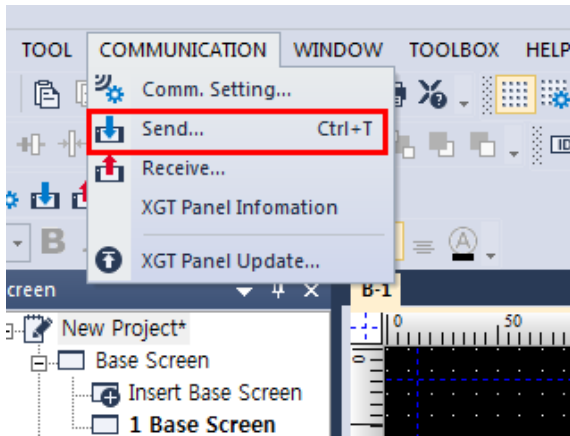

- 2 Select [Execute Project at Local wXP]

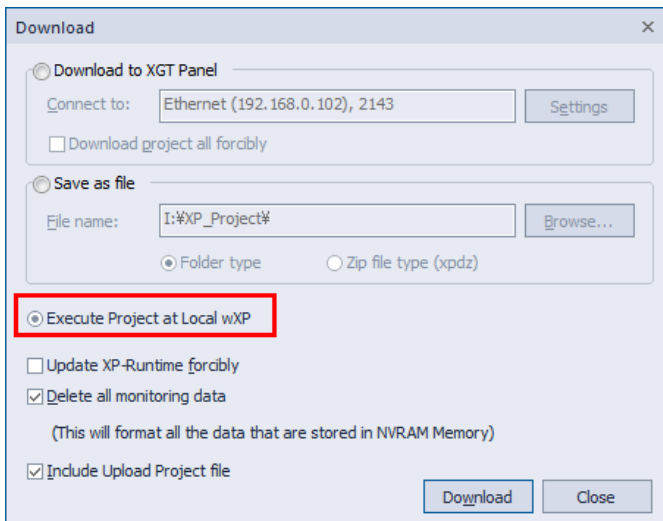

- 3 Click [Download].
The project and wXP will start automatically.

4 If the option (Goto screen after boot up) is selected, it will go into monitoring mode.

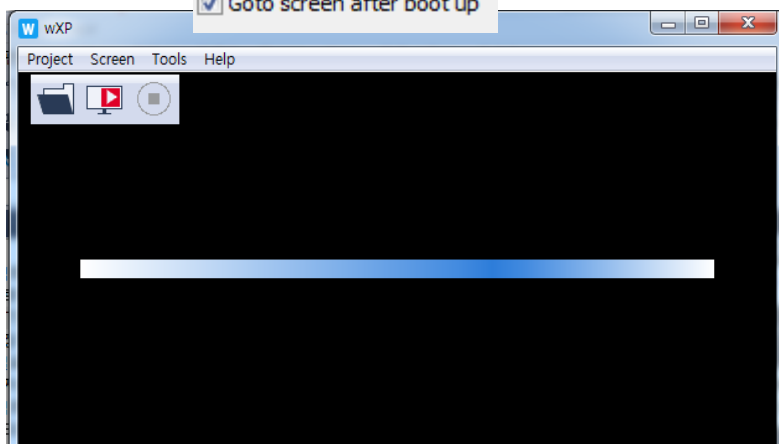

Note

You can only start wXP projects on local wXP. The wXP must be a compatible version with the XP-Builder or it must be updated.

2.8.4 Receiving a Project File from an XGT Panel

You can transfer project file from an XGT Panel to your computer.

To receive a project file:

- 1 In XP-Builder, click [Communication] ► [Receive] or select the upload icon () from the toolbar.



- 2 If necessary, click [Settings] to change the communication settings.

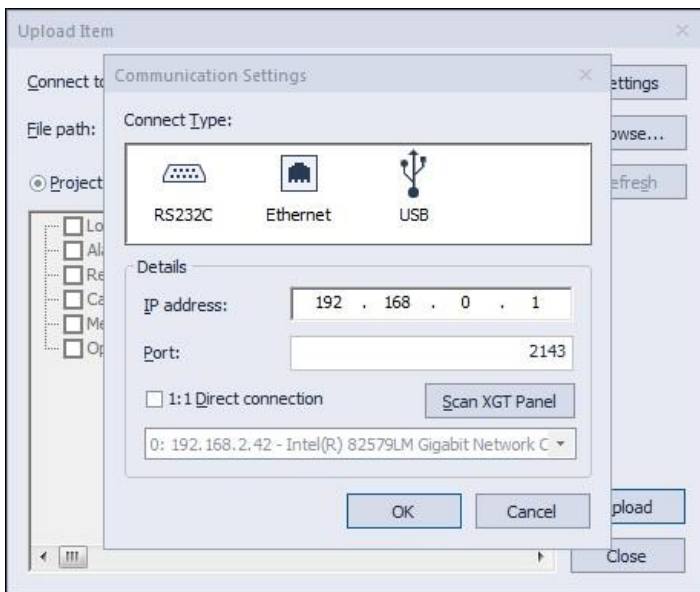

- 3 Click [Browse] to select a destination folder for the project file. If you do not set the destination, you cannot receive the project file from an XGT Panel.

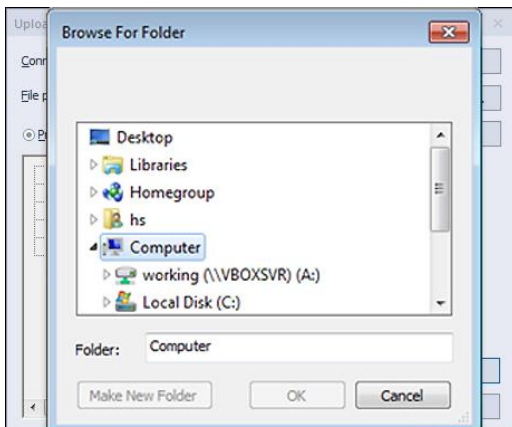

- 4 Select **Project file** to transfer the entire project. Select **Backup data** to specify which types of data to transfer.

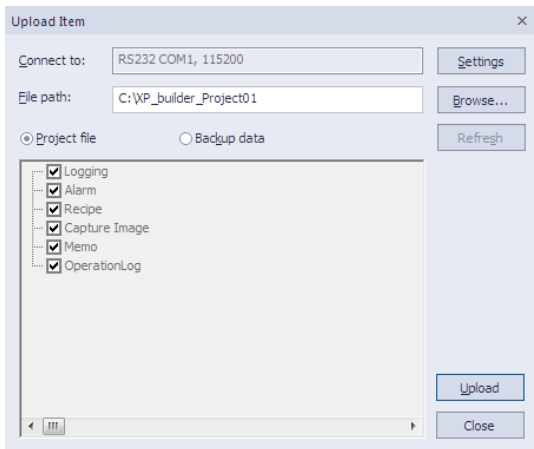

- 5 Click [Upload].

Note

You cannot receive images unless you have selected the **Include Upload Project File** option when transferring the project to the XGT Panel.

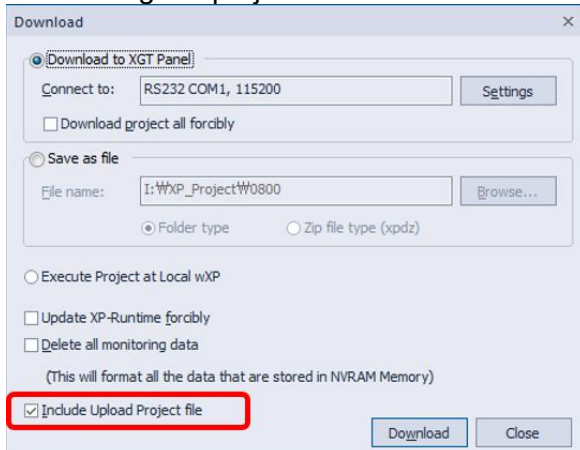

2.8.5 Backing up Project Data

You can back up project data from a removable storage drive in an XGT Panel to your computer, including logging and alarm data, recipes, screen captures, operation logs, and memos.

To back up project data:

- 1 In XP-Builder, click [Communication] ► [Receive] or select the upload icon () from the toolbar.



- 2 Click [Backup data].

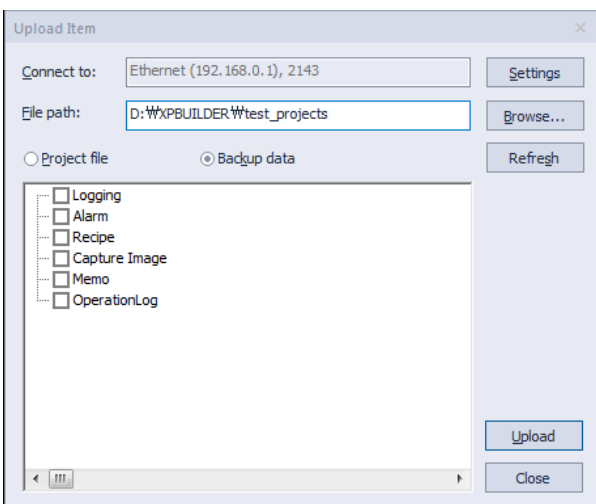

- 3 Click [Browse] to select a destination folder for the project data.

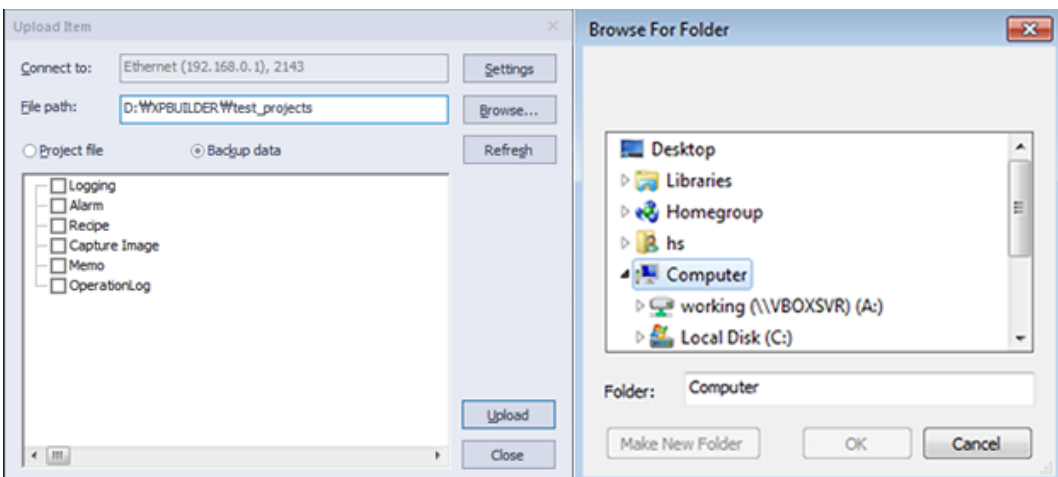

- 4 Select Backup data. You can click the checkboxes in the list to specify which types of data to transfer.

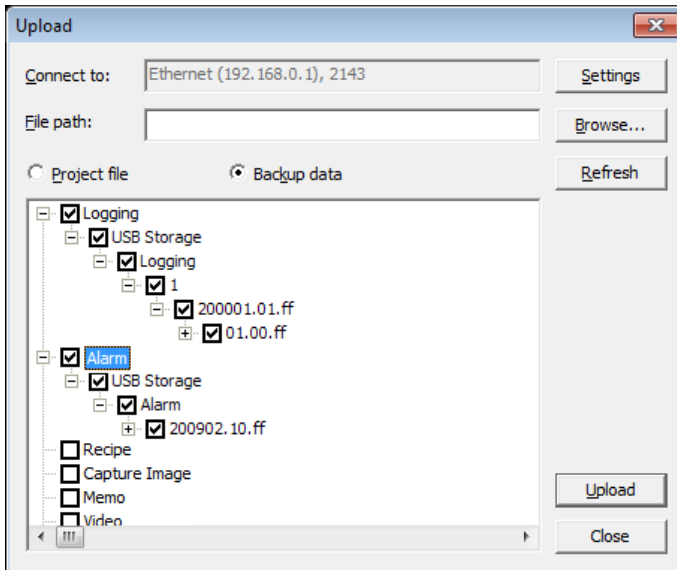

- 5 Click [Upload].

- 6 If a communication password is set, enter the password for the XGT Panel and click [OK]. In XP-Builder, the transfer progress will be shown in the output window.

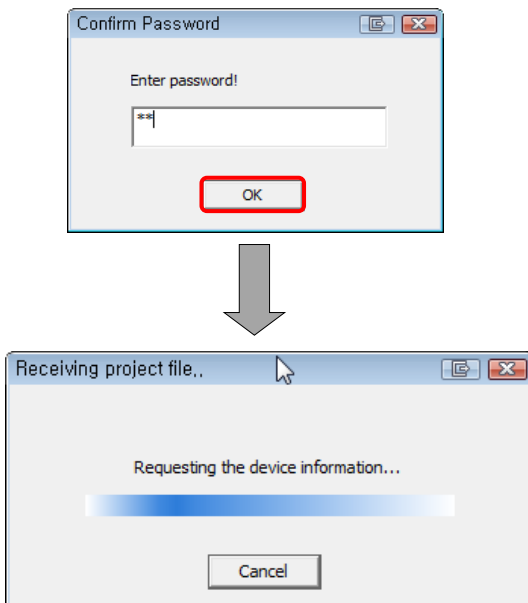

Note

Logging, alarm, operation log and recipe data are stored in CSV format. Memos and screen captures are saved in BMP format.

2.8.6 Discontinued Project Conversion

As XP series is discontinued, XP-Builder (V3.00 or later) will no longer be able to edit, save and download the model. Therefore, supporting to provide the ability to change the discontinued model to another model.

Convert project:

- 1 Open XP project.

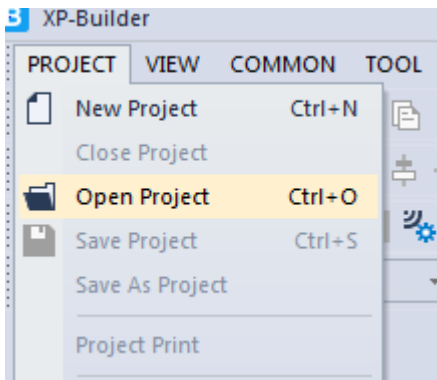

- 2 Click [OK] on the message below.

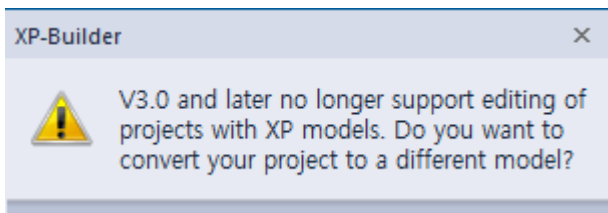

If you click [Cancel], project will be closed.

- 3 Select other series model instead of XP series model on [Project Property] – [XGT Panel Settings] after click [OK]

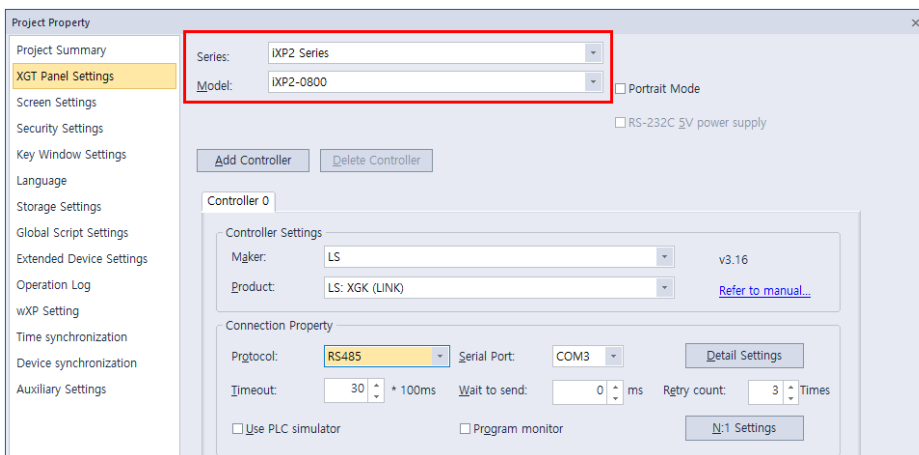

If you click [Cancel], project will be closed.

- 4 Click [Save Project] or [Save As Project] to save the project.

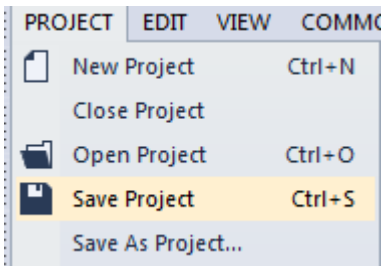
**Note**

When uploading XP project, model conversion is done as above.

2.9 Configuring Advanced Communication Settings

XP-Builder supports several communication types to allow for flexible controller and panel configurations. This section describes the communication types available.

Multiple controllers can be monitored from a single XGT Panel. The XP series panels support up to 4 connection numbers (0-3) and the iXP/IPC series panels support up to 16 connection numbers (0-15) for different types of controllers, when connected to multiple protocols (RS232C, RS422/485, and Ethernet).

2.9.1 Using 1: N Communication with Multiple Protocols

When setting up 1: N communication with multiple protocols, you can connect various types of controllers via the different protocols. The RS485/RS422 supports multi-drop connection, which allows you to connect one XGT Panel to multiple controllers. The Ethernet connection also allows connection of multiple controllers.

You can connect up to 4 different controllers for XP/eXP series panels or up to 16 different controllers for eXP/iXP/IPC/iXP2 series panels. A multi-channel setup of 1: N communication is illustrated by the following image (XP Series).

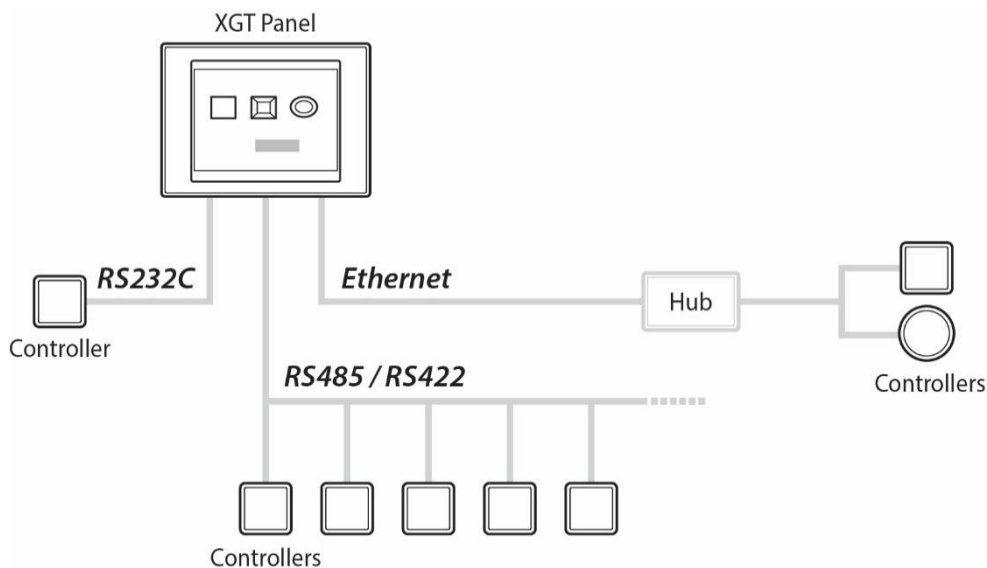

Note

- When you connect controllers via RS232C only, you can connect only one controller from each series.
- When you connect controllers via Ethernet only, you can connect 4 XP series controllers, and 16 eXP/iXP/iXP2/eXP2/IPC series controllers.

To use 1: N communication:

- 1 In XP-Builder, click [Common] ► [Project Property Setting] ► [XGT Panel Settings] ► [Add Controller].

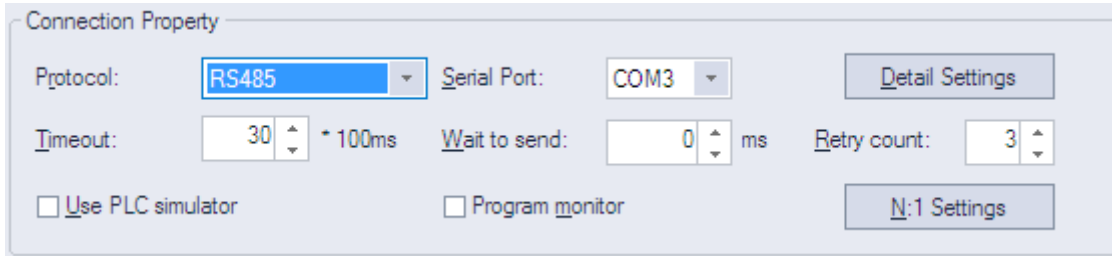

- 2 Select the PLC and manufacturer from the drop-down list. If necessary, click [Detail Settings] and change the properties.

Note

To delete a controller, select it from the list and click [Delete Controller].

2.9.2 Using 1: N Communication with RS485/RS422

When setting up 1: N communication with RS485, you can connect a large number of controllers, as long as they are all the same type and manufacturer of controller. With a RS485 connection, you can also set station numbers for devices in the advanced communication settings, so that the same device can be referenced by multiple controllers with unique station IDs. A multi-drop setup of 1: N communication with RS485 is illustrated by the following image.

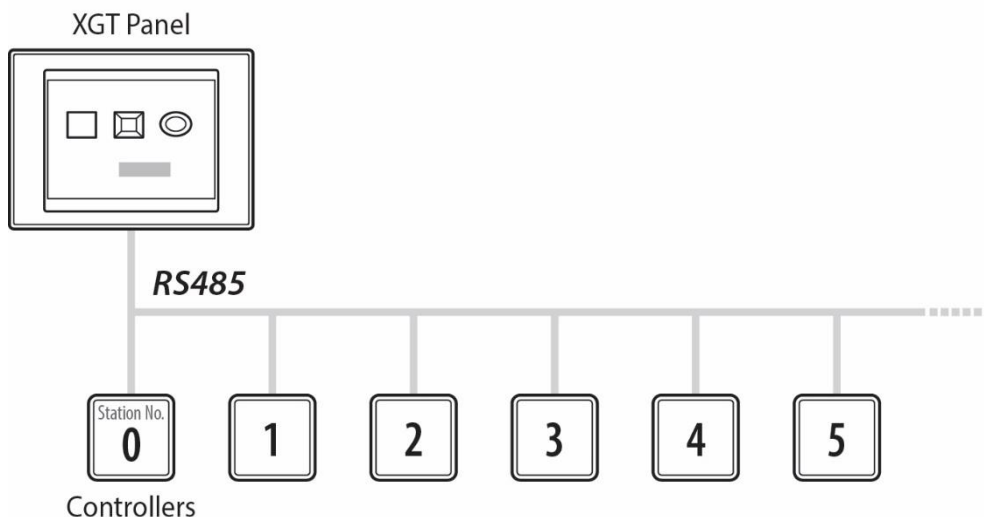

To use 1: N communication:

1 In XP-Builder, click [Common] ► [Project Property Setting] ► [XGT Panel Settings].

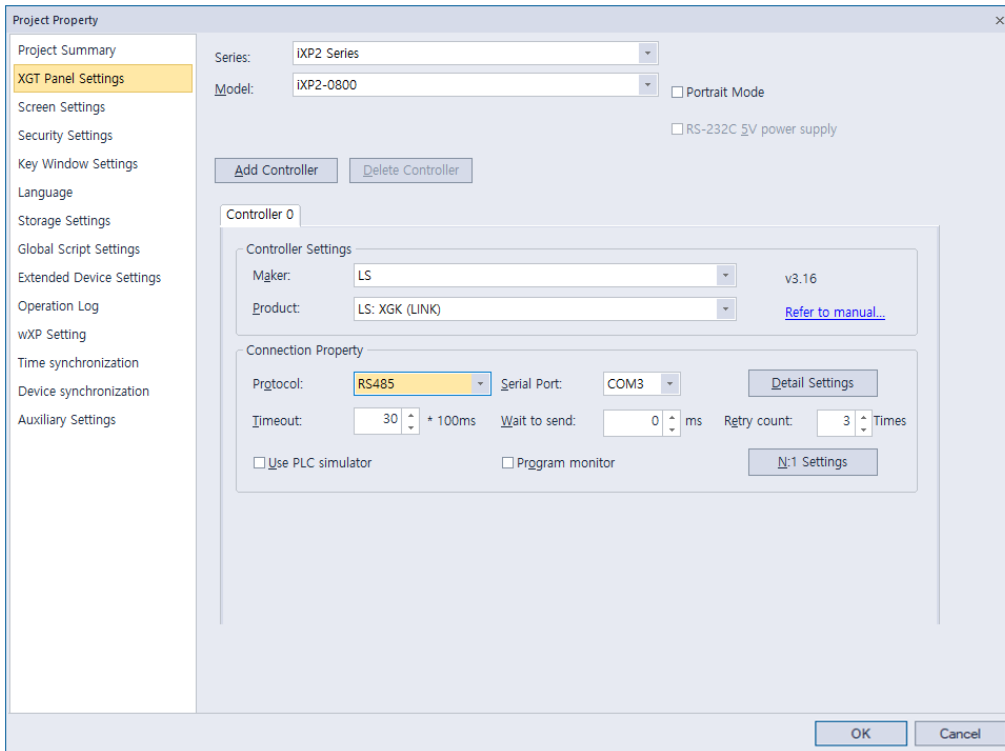

2 In the connection properties, select **RS485**.

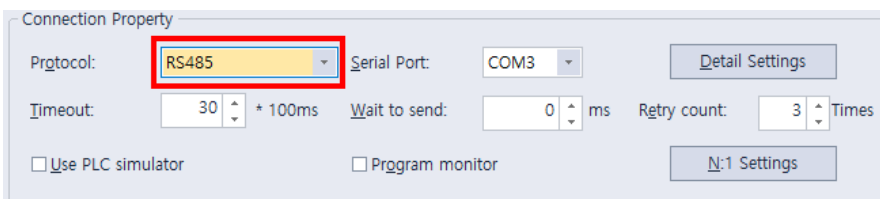

3 In the object settings, click  to set the properties.

4 Check the box next to **Custom setting**.

5 Set the station number.

Bit Device ? x

Tag

0: LS: XGK (LINK)

Device Select

P 0000

P0000

7	8	9	Clr	Back	
4	5	6	A	B	C
1	2	3	D	E	F
0	.	Enter			

XGK PLC P I/O Register
Bit: P0123A (0~4095F)
Word: P0123 (0~4095)

Network

Use default Custom setting

Network ID: 255 Station No.: 0

OK Cancel

2.9.3 Using N: 1 Communication

This is a useful way to make several XGT Panels to communicate with one PLC. N: 1 communication is available only with the RS-485 communication protocol and uses a token ring bus to regulate communication. Only one XGT Panel can hold the token at a time and the token is passed after a defined holding time. The XGT Panel that you set to station “0” is the starting point for communication. After the token is released, it is delivered to station “1” and so on.

To use N: 1 communication, set the communication parameters:

1 In XP-Builder, click [Common] ► [Project Property Setting] ► [XGT Panel Settings].

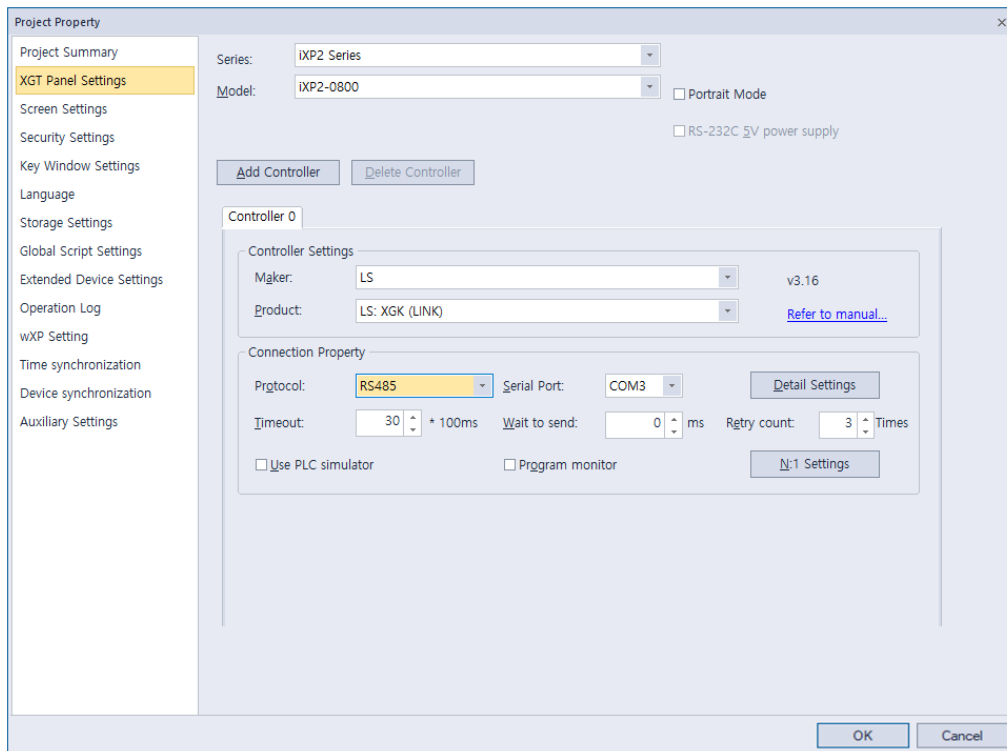

2 In the **Connection Property** area, set [Protocol] to **RS485**.

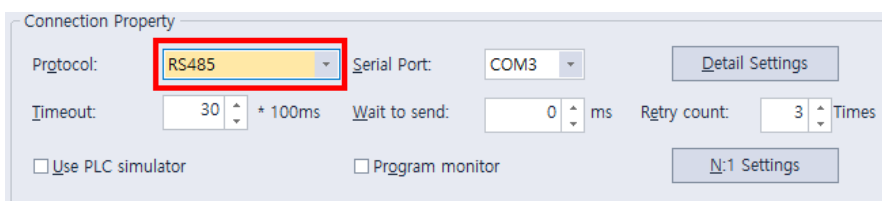

3 Click [N: 1 Settings].

4 Click the checkbox next to **Use N: 1 Communication** and input the following parameters:

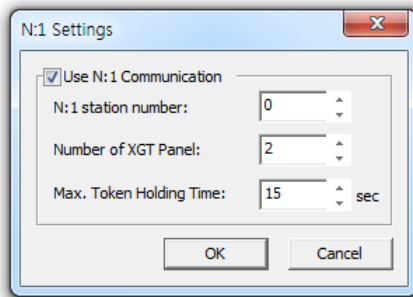

N: 1 Settings	Description
Use N: 1 Communication	Select whether or not to use N: 1 communication.
N: 1 Station Number	Select a station number (0-15) for the HMI. The first station must be set to "0." Station numbers must be continuous, or communication will fail. Duplicated station numbers are not allowed.
Number of XGT Panel	Select the total number of XGT panels you are using (up to 16).
Max. Token Holding Time	Select the maximum time that each panel can hold the token (up to 60 seconds). The token is automatically released when the maximum time is reached. <div style="text-align: center; margin-top: 10px;"> </div>

Note

- The total number of XGT Panels you specify must match the total number of stations exactly.
- The N: 1 Settings option appears when you select a controller that supports N: 1 communication.
- The more XGT panels you connect, the slower the communication speed will be.
- All XGT Panels participating in N: 1 communication should have the same controller settings and parameter settings (except for station numbers).
- When using N: 1 communication, the Program Monitor function is not supported and the controller monitor protocol cannot be used, which results in decreased communication speed.
- N: 1 communication does not function in the simulator.

The following drivers support N: 1 communication.

Manufacturer	Driver
LS	LS: XGK(LINK)
	LS: XGI/XGR/XEC(LINK)

Manufacturer	Driver
	LS: XGB(LINK)
	LS: GM(LINK)
	LS: MASTER-K(80, 120, 200, 300, 1000)S(LINK)
	LS: Inverter (LSBus)
	LS: Inverter (MODBUS)
	LS: XEC (LINK)
	LS: XGB (LINK)-VCB Trip Control
LS Mecapion	LS Mecapion: VS/VP Servo Drive
Mitsubishi Electric Corporation	MITSUBISHI: MELSEC-A(LINK)
	MITSUBISHI: MELSEC-QnA, Q(LINK)
	MITSUBISHI: MELSEC-FX(LINK)

2.9.3.1 Token Hold

The N:1 communication provides slower communication speed than the 1:1 connection. To enhance the communication speed on a temporary basis, you can set an XGT Panel to hold the token for a specified time before it passes the token to the next XGT panel.

To set the Token Hold function:

- 1** Create a projects for N:1 communication.
- 2** Configure the communication setting for N:1 connection.
- 3** Add a switch on a base screen.
- 4** Assign the “_N1_Token_Hold” tag to the switch’s device.

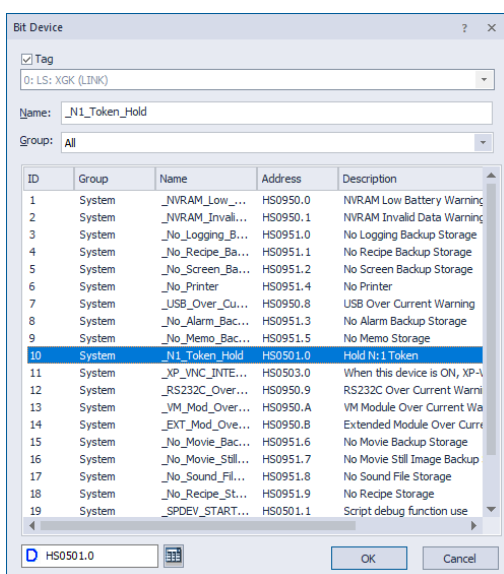

5 Download the project to an XGT Panel.

- You can press the switch to perform a token hold and enhance the connection speed.

Note

- You can enable the token hold using a script.
- Token Hold takes effect after the XGT Panel obtains the token.
- Token Hold can be used on a temporary basis only.

2.9.3.2 N:1 System Devices

The following table lists system devices for use with N:1 communication.

Tag Name	Device	Type	Description
_N1-Token	HS0070.0	BIT	When a token is held by XGT Panels, this system device is either On or OFF. Read-only device.
_N1-Token_Hold	HS0501.0	BIT	N:1 Token Hold is available. Read/Write device.
_N1-Token_Station	HS0071	WORD	N:1 station ID of an XGT Panel holding a token. Read-only.
_N1-Token_Count	HS0072	WORD	The number of times an N:1 token is held. Read-only.
_N1_Station	HS0073	WORD	The N:1 station ID of an XGT Panel.

2.9.4 View Communication Manual

Describes how to view the communication manual. There are three ways to view the communication manual as shown below.

Method 1: View communication manual in HELP

1 In XP-Builder, click [HELP] ► [PLC/Controller Manual] ► [Communication Driver].

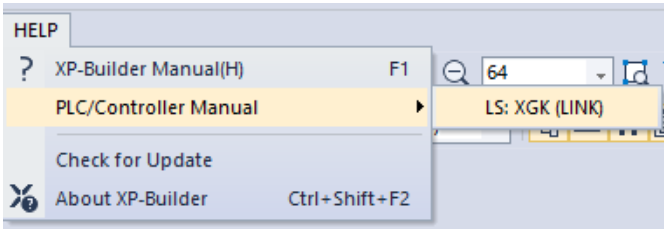

Method 2: View communication manual in Project Property

1 In XP-Builder, click [Common] ► [Project Property Setting] ► [XGT Panel Setting].

2 Click [Refer to Manual]

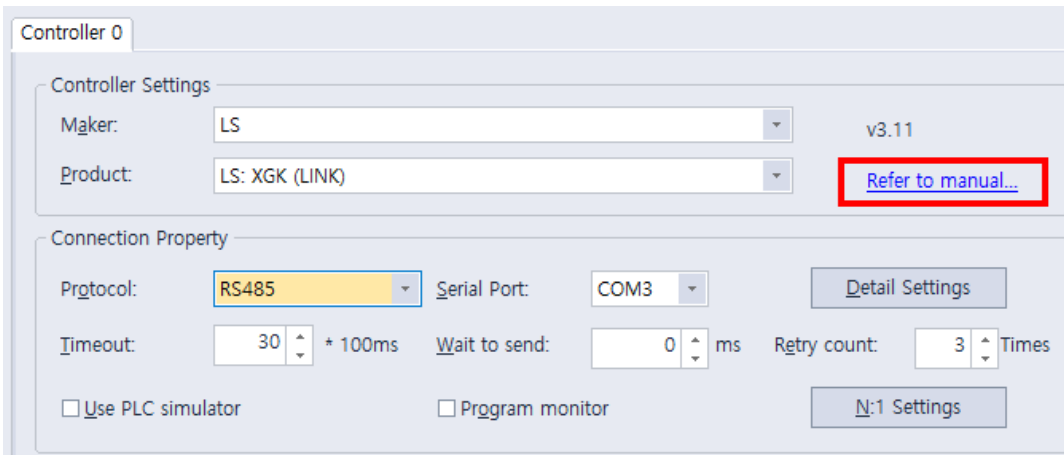

Method 3: View communication manual in

1 Open the device dialog being edited.

2 Click "?", and then click anywhere within the device dialog box. Alternatively, you can view the communication manual by pressing the keyboard "F1" key.

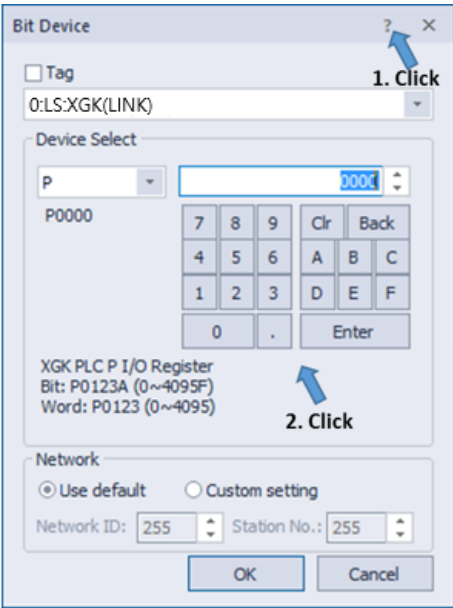

3. Error Messages

In XP-Builder, you may be notified of an error via a code in the Results pane or a message in a pop-up window. In these cases, locate the error in the corresponding sections that follow and take the appropriate steps to resolve the error.

3.1 Resolving Error Codes Found in the Results Pane

The following table lists error codes that appear in the Results pane. The errors and suggestions for resolving them are listed in order by code number.

Code	Error Message	How to Resolve the Error
1000	There is no background image.	The image set for the background does not exist. Choose another image for the background.
1001	There is (are) shape(s) that is out of the screen area.	Check the project in XP-Builder and make sure that all the shapes and objects are placed within the base screen.
1002	The "XX" screen No. "XX" is incorrect. Screen No. should be below 65535.	The screen number exceeded the limit. Specify a screen number smaller than "65535."
1003	Invalid script "XX" is selected.	The selected script does not exist. Replace the script with another one or create and register a new script.
1004	It is impossible to place more than "XX" popup window object onto the screen.	More than 8 window objects have been registered. Delete window objects until 8 or fewer remain.
1005	The size of the window exceeds maximum one of the HMI screen.	A window cannot be larger than the dimensions supported by the XGT Panel type specified. Set the window size to fit within the maximum dimensions allowed by the XGT Panel type.
2000	The image information is incorrect. (ex. 1. The image is not selected. 2. The image format is not valid.)	The specified image has been deleted or the file extension is incorrect. Select another image or select an image type that is supported.
2001	"XX" is incorrect.	The specified display does not exist. Change the display type and number of the object.
2002	The address is incorrect.	The device type is incorrect or the device address has not been set. Set or change the device address.
2004	A deleted or incorrect text table is used.	The specified text table does not exist. Specify another text table.
2005	The script "XX" that is not set is selected.	The specified script does not exist. Specify another script.

Code	Error Message	How to Resolve the Error
2007	The selected font "XX" cannot represent all of headers set "XX".	The font you selected cannot be found or does not support the double-byte characters you used in the heading. You must reinstall the font, select a font that supports the characters in the heading, or change the heading.
2008	There is an object or figure that is out of the screen area.	The object is outside the boundaries of the window. Relocate the object or adjust the size until it fits within the window boundaries.
2009	The selected font "XX" is not installed in the system.	The font you selected cannot be found. You must reinstall the font.
2011	The selected image is of the type that is not supported.	The specified image type is not supported. Delete the image or select an image type that is supported.
2012	In the selected "XX", the monitor address exists. Unexpected results may occur.	The variable type is incorrect in the script. Change the variable to a temporary variable to display a result without writing it in the standard device.
2013	The selected history alarm to print does not exist.	The history alarm list in a special switch or multi switch has been deleted. Specify another history alarm list.
2014	The maximum device address is exceeded ("XX" rows, "XX" columns)	The number of rows and lines you set exceed the maximum device range. Set the number of rows and lines to fall within the maximum device range.
2015	["XX"] device is read-only.	You have set a read-only device where a write device is required. Specify a write device for the object.
2016	There is no lamp case. Default case will be showed.	The specified condition for a word lamp does not exist. Add a condition for the word lamp.
2017	The keypad position is out of screen.	The key window location is outside the dimensions of the window boundaries. Change the window location to fit within the window boundaries.
2018	The Selected Logging Group ID : ["XX"] does not exist	The specified logging group does not exist. Register the logging group in the logging properties.
2019	Object that has same cursor group ID and input order exists. Arrange its order.	Two objects have the same automatic cursor and input order numbers. Change the automatic cursor and input order to unique numbers or remove the object with the redundant setting.
2021	The number of connected plc type is invalid	The specified controller does not support program monitoring. Change the function of the special switch or specify a controller that supports program monitoring.
2022	The ladder monitoring option is not set. Please check ladder monitoring option in [Common]-	The program monitor function has not been set for the object. Change the function of the special switch or activate program monitoring in the device

Code	Error Message	How to Resolve the Error
	[Project Property Setting]-[XGT Panel Settings]	settings.
2024	There is no (trend) item. At least, one (trend) item must be added.	Trend item has not been added. Add trend item(s)
2025	There is an object or figure that is out of the screen area.	An object or image location is outside the dimensions of the window boundaries. Change the object or image location to fit within the window boundaries.
2026	The range of Group Num. is from 1 to 253.	The specified number is beyond the allowable range for a group number. Specify a number from 1 to 253.
2027	The device address must be Internal device address.	Only an internal device type can be specified for this function. Change the device type to an internal device.
2028	The font of code page is not valid. Please check the [common]-[Project Property Setting]-[Language]-[multilingual font].	No font is specified for the selected language. Specify a font in the language settings.
2029	The program path, parameter or file path is not valid.	The path and filename are incorrect for an external program. Enter the correct path and filename.
2030	The selected object or feature is not supported in the current model.	<p>This error occurs when an unsupported feature is selected in a project (e.g., when a PDF viewer object is used in an XP series panel). The following command will be cleared or deleted:</p> <p>The following option is not supported on the XP30-BTE, XP30-TTE, XP40-TTE, or the XP50-TTE.</p> <ul style="list-style-type: none"> ● Rotate Object text ● Numeric input and Switch operation log ● Text display bit/word address ● Lamp and switch text blink ● If the N-state lamp object exceeds 6. (Only when changed by bit.) ● VNC/ PDF viewer and associated special switch ● File browser and associated special switches ● Set parameters for an external program start switch. ● View character string function in view history alarm. ● If the N-state lamp object exceeds 6. (Only when

Code	Error Message	How to Resolve the Error
		<p>changed by bit.)</p> <ul style="list-style-type: none"> ● Select [Setting device size per Col.], [Setting of cell size] in View Logging ● Show lamp and switch trigger ● Bookmark Logging Trend Graph ● Word switch increase/decrease repeat. ● Set text intervals and line spacing for Figures and Word Form ● Character/spacing cannot be set when the length of the character string is set for switches/lamps.
2031	The following external storage devices are not supported:	This error occurs when an SD card is assigned as the external storage in an unsupported device, such as an XP series panel. The XP series is set on the SD storage device or the storage device is not supported. Change the external storage path to clear the error.
2032	The number of characters allowed is 1–4. (16 bits: 1–2, 32bits: 1–4)	This error occurs in a logging viewer object when the number of ASCII characters exceeds the allowed range. Change the number of ASCII characters to stay within the allowed range.
2034	Exceeded the maximum number of characters. ([0–255])	This error occurs in switch and lamp objects when the caption length exceeds 255 characters. Resize the caption length.
2036	Available in multilingual mode - Initializes keypad settings. Check the settings at [Language]-[Multilingual font], and [Keypad].	To use the Korean keypad for a text input object, set the language to Korea in the properties window ([Language]-[Multilingual font]-[Korean]).
2037	The language setting is invalid.	This error occurs in [special switch] and [multi switch] objects, if a language used in the language change feature is deleted. Check [Language]-[Runtime language list] in the project properties, or change the language settings.
3000	The initial screen setting “XX” is incorrect.	The specified start screen does not exist. Specify an existing screen or create a new screen to use as the start screen.
3002	The key window [“XX”] is incorrect.	The specified key window does not exist. Specify an existing window or create a new window to use as the key window.
3003	The default screen-converting	The window change device has not been specified.

3. Error Messages

Code	Error Message	How to Resolve the Error
	device is incorrect.	Specify the device in the project properties window.
3004	The Global window 1-converting device is incorrect.	The window change device has not been specified. Specify the device in the project properties window.
3005	The Global window 2-converting device is incorrect.	The window change device has not been specified. Specify the device in the project properties window.
4000	The trigger device of the logging "XX" is incorrect.	The device has not been specified. Specify the device in the logging properties.
4001	The sampling device of the logging "XX" is incorrect.	The device has not been specified. Specify the device in the logging properties.
4002	The progress device of the logging "XX" is incorrect.	The device has not been specified. Specify the device in the logging properties.
4003	The cancel device of the logging "XX" is incorrect.	The device has not been specified. Specify the device in the logging properties.
4004	The file full device of the logging "XX" is incorrect.	The device has not been specified. Specify the device in the logging properties.
4005	The data clear device of the logging "XX" is incorrect.	The device has not been specified. Specify the device in the logging properties.
4006	The backup trigger device of the logging "XX" is incorrect.	The device has not been specified. Specify the device in the logging properties.
4007	The backup complete device of the logging "XX" is incorrect.	The device has not been specified. Specify the device in the logging properties.
4008	The logging area setting is incorrect.	The logging storage area has not been specified. Specify the storage area in the logging area settings.
4009	The maximum logging size is exceeded. ("XX" bytes).	The sum of the specified storage areas exceeds the maximum logging area size. Adjust the storage areas to fit within the maximum size.
4010	The logging area is not set.	The logging storage area has not been specified. Specify the storage area in the logging area settings.
4014	The backup path of the logging is not selected.	The logging backup path has not been specified. Specify the backup path in the logging properties.
4015	The setting of the logging sampling device is incorrect. The maximum device size that is able to be set by the number of the sampling devices is exceeded.	The maximum number of devices to log has been exceeded. Reduce the number of device to log until it is within the maximum.
4016	The control device of the logging "XX" has a duplicated setting. The duplication of a control device is	Two logging control devices have the same number. Change one of the devices to a unique number.

Code	Error Message	How to Resolve the Error
	not permitted.	
5000	The setting of the occurred alarm count device is incorrect.	The device has not been specified. Specify the device in the alarm properties.
5001	The setting of the monitoring device is incorrect or not applied to all registered alarms.	All required devices have not been specified or a device address is incorrect. Specify a device or verify specified devices in the flow alarm settings.
5002	The monitoring device is duplicated.	Two flow alarm devices have the same number. Change one of the devices to a unique number.
5003	[Flow alarm "XX"] The message setting is incorrect.	No alarm message has been selected. Select an alarm message.
7000	The setting of the not restored alarm count device is incorrect.	The device has not been specified. Specify the device in the history alarm properties.
7001	The setting of the alarm data clear device is incorrect.	The device has not been specified. Specify the device in the history alarm properties.
7002	The setting of the alarm print trigger device is incorrect.	The device has not been specified. Specify the device in the history alarm properties.
7003	The setting of the alarm print end device is incorrect.	The device has not been specified. Specify the device in the history alarm properties.
7004	The setting of the history alarm data obtaining-period is incorrect.	The specified history alarm acquisition cycle contains an error. Verify the cycle in the history alarm properties.
7005	There is no content of the string of the alarm group "XX".	The alarm group display text has not been selected. Select display text in the group properties window.
7006	The string table setting of the alarm list "XX" is incorrect.	No text has been selected in the alarm list. Select a text table or create and specify a new text table for the alarm list.
7007	The monitoring device setting of the alarm list "XX" is incorrect.	The device has not been specified. Specify the device in the alarm list settings.
7008	The range setting of the alarm list "XX" is incorrect.	The specified conditional expression in the alarm list contains an error. Verify the expression in the alarm list settings.
7009	The detail window number setting of the alarm list "XX" is incorrect.	The detailed display setting in the alarm list contains an error. Verify the setting in the alarm list settings.
7010	The message setting of the alarm list "XX" is incorrect.	No alarm message has been set. Select a text string from a text table in the alarm list to use as the alarm message.
7011	The alarm lists "XX" and "XX" are set to watch the same device.	Two history alarms are set to monitor the same device. Specify a unique device for one of the alarms or delete one of the alarms.

3. Error Messages

Code	Error Message	How to Resolve the Error
7012	All the sampling devices of the alarm list "XX" should be set.	Some devices in the alarm list have not been specified. Specify all devices in the alarm list.
7013	The monitoring device of the alarm list "XX" is duplicated.	Two history alarms are set to monitor the same device. Specify a unique device for one of the alarms or delete one of the alarms.
7014	The word condition information setting of the monitoring device of the alarm list "XX" is incorrect.	The specified conditional expression in the alarm list contains an error. Verify the expression in the alarm list settings.
8000	The setting of the write trigger device is incorrect.	The device has not been specified. Specify the device in the recipe properties window.
8001	The setting of the read trigger device is incorrect.	The device has not been specified. Specify the device in the recipe properties window.
8002	The backup device setting is incorrect.	The device has not been specified. Specify the device in the recipe properties window.
8003	The setting of the recipe number device is incorrect.	The device has not been specified. Specify the device in the recipe properties window.
8004	The setting of the recipe block number device is incorrect.	The device has not been specified. Specify the device in the recipe properties window.
8005	The setting of the recipe data transfer complete device is incorrect.	The device has not been specified. Specify the device in the recipe properties window.
8006	The setting of the recipe data transfer error device is incorrect.	The device has not been specified. Specify the device in the recipe properties window.
8007	The setting of the recipe sampling device is incorrect.	The device has not been specified. Specify the device in the recipe properties window.
8008	The maximum recipe setting size ("XX" KB) is exceeded.	The sum of the specified recipes exceeds the maximum memory size. Adjust the number of data blocks within the recipes to fit within the maximum size.
8009	The backup path of the recipe is not selected.	Set the recipe backup path in the recipe properties window.
8010	The setting of the recipe sampling device is incorrect. Check whether the maximum device setting size is exceeded by the number of the recipe devices.	The device has not been specified or the number of devices exceeds the maximum allowed. Verify the specified devices in the recipe entry window.
9000	The download data size ("XX" bytes) exceeds the maximum size ("XX" bytes).	The total size of the selected data exceeds the maximum memory available for download to the XGT Panel. Unselect items to reduce the total data size and try again.
9001	The font used in the project ("XX")	The specified font is not installed on the system.

Code	Error Message	How to Resolve the Error
11000	is not installed in the system. Change to a font installed in the system. Otherwise, strings may not appear.	Install the font on the system or specify another font in the project properties.
	Cannot find the font file ["XX"].	The specified font cannot be found or is not installed on the system. Try restarting XP-Builder. If the problem reoccurs, install the font on the system or specify another font in the project properties.
11001	There is a character that cannot be printed with the font ["XX"]. Check whether a character that is of the incompatible font is used.	The selected font cannot display the special characters you are using. You must select another font that is capable of displaying the special characters.
13001	There is no script selected as operation.	The specified script does not exist. Specify another script or create a new script.
15000	Backup file conversion: Cannot open backup file.	The file may be in use. Ensure that the file is closed and try again.
15001	Backup file conversion: Cannot create output file.	The file may be in use. Ensure that the file is closed and try again.
15002	Backup file conversion: Cannot access backup file.	The file may be in use. Ensure that the file is closed and try again.
15003	Backup file conversion: Cannot read backup file.	The file may be in use. Ensure that the file is closed and try again.
15004	Backup file conversion: Cannot write to backup file.	The file may be in use. Ensure that the file is closed and try again.
16001	The write-prohibited device is used as a write device, in the script.	You have set a read-only device where a write device is required. Specify a write device for the script.
16002	The read-prohibited device is used as a read device, in the script.	You have set an input device where a read device is required. Specify a read device for the script.

3.2 Resolving Error Messages in Pop-up Windows

The following table shows how to resolve error messages that appear in pop-up windows within the XP-Builder interface. These error messages have no error codes. They are listed in the following table alphabetically.

Error Message	How to Resolve the Error
"XX" cannot be specified as an interval. The scale interval is between 0 and 10.	Set the scale interval for the graph between 0 and 10.
"XX" cannot be specified as the number of scale. The scale number is between 0 and 255.	Set the number of scales in the graph object between 0 and 255.
"XX" is not a 16 BCD data type. Enter a value between 0~9999.	If the size and form of the device is 16 bit BCD, you must set the conditional range between 0 and 9,999.
"XX" is not a 16 bit signed data type. Enter a value between -32768~32767.	If the device size and type is signed 16 bit, you must set the conditional range between 32,768 and 32,767.
"XX" is not a 16 bit unsigned data type. Enter a value between 0~65535.	If the device size and type is unsigned 16 bit, you must set the conditional range between 0 and 65,535.
"XX" is not a 32 bit BCD data type. Enter a value between 0~99999999.	If the device size and type is 32 bit BCD, you must set the conditional range between 0 and 99,999,999.
"XX" is not a 32 bit signed data type. Enter a value between -2147483648 and 2147483647.	If the device size and type is signed 32 bit, you must set the conditional range between -2,147,483,648 and 2,147,483,647.
A mobile GIF cannot be used as an image of an object/figure.	Select another image type.
A temporary directory is a place to store a temporary XGT file, so you cannot save or open a file here.	You cannot save or open files in the temporary directory. Specify another file location.
Caption "XX" cannot be all displayed with the currently set font "YY." Choose the font meeting the entered contents.	This error occurs when the selected font cannot display the double-byte characters used in the caption. Change the font or translate the caption into a language that is supported by the selected font.
Changed into an indirect method. All the expressions of the built conditional sentences are deleted.	This message appears when the method of selecting the message or display for the word message, word component, or word window has been changed from [Status] to [Condition].
Communication connection has been failed.	There is no connection to the XGT Panel. Check the connection to the XGT Panel and the communication settings.
Connection passwords are different.	The password you entered is incorrect. Re-enter the connection password for the XGT Panel.

Error Message	How to Resolve the Error
Disconnected. Try again after connection.	This error occurs when the XGT Panel is disconnected. Check the connection between your computer and the XGT Panel and ensure that the communication settings are correct.
Edit device is Read-Only. Use writable device.	Device input fails when the object does not support writing. Some objects support both reading and writing, but other devices, such as lamps, are read-only devices. To support device input, you must use a writable device, such as a switch, number input, or character input object. For more information about object types, refer to <4.3 Objects>.
File transformation error	This error occurs when the file to be transferred cannot be read, due to an error in the file. Download the project to the XGT Panel again. Refer to <2.8.1 Transferring to an XGT Panel>.
Graphic library load has been failed.	The image library is corrupt or damaged. You must create a new image library.
More than 10M cannot be downloaded.	The XGT panel that is currently connected has only 10 MB of available memory. You cannot transfer a file larger than 10 MB.
No reply within the set period or disconnected	This error may occur during data transfer. Check the connection between your computer and the XGT Panel and the power cable for the XGT Panel.
Object library load has been failed.	The object library is corrupt or damaged. You must create a new object library.
Password setting has been failed.	The new password cannot be set. Check the connection to the XGT Panel and the communication settings.
Problem with data	This error occurs when incorrect data is included in the transfer. Try the transfer again.
Save the project file.	Enter a file name and save the project file.
Save the project first.	This error occurs when you attempt to transfer a project without saving it first. Save the project and try again.
Shift to the XGT Panel program update mode.	This error occurs when you attempt to update the XGT Panel while the panel is in the normal operating mode, instead of the update mode. On the XGT Panel, touch and hold the screen to access the XGT Panel menu, and then select the update mode.
The “XX” set lines exceed the maximum display range.	The number of lines set in the object exceeds the horizontal dimensions of the screen.
The “XX” set rows exceed the maximum display range.	The number of rows set in the object exceeds the vertical dimensions of the screen. Set the number of rows below the maximum.
The backup data you want to download is not in XGT Panel.	This error occurs when there is no backup data in the XGT Panel.
The backup path has been incorrectly designated.	The download path for the font or image file is incorrect. Ensure that a USB drive is connected or a CF card is installed in the

Error Message	How to Resolve the Error
	XGT Panel and then modify the download path in the project properties information.
The color is a user library larger than the number of colors that an XGT model can have now.	The XGT Panel that is currently connected does not support color. You must change the project settings to black and white or connect to an XGT Panel that supports color.
The compressed project file you want to download is not in the XGT Panel.	This error occurs when a compressed project file does not exist on the XGT Panel. To include the compressed project file when transferring a project to an XGT Panel, refer to <2.8.1 Transferring to an XGT Panel> .
The executable file in the device and the executable file to send are not the same.	The executable file has been modified. Transfer the entire project to the XGT Panel.
The file already exists. Would you overwrite?	A file with the same name exists in the directory you specified. Click [Yes] to select another destination for the file or [Cancel] to discontinue saving the file.
The file cannot be read. Check whether another program is being used.	The download file is locked. This may occur if the project file is being accessed by another connected computer. If that is case, ensure that the project is not open by more than one computer and try again.
The file is not writable. Check the disk memory.	This error occurs when there is insufficient memory in the XGT Panel to store the file. Check the memory in the XGT Panel and make additional memory available, if necessary.
The maximum value must be larger than the minimum value.	Set the maximum value to be larger than the minimum value.
The number of characters that can be displayed should be an even number.	Set the number of characters in the character indicator and character input/output units to an even number.
The number of the X axis displays that can be selected is between 3 and 120. Check and enter again.	The range of acceptable display numbers has been exceeded. Set the number of X axis displays in the trend graph [Display] between 3 and 120.
The password is incorrect.	Enter the correct password.
The previous project information is not available.	An earlier version of the project does not exist on the XGT Panel. Transfer the entire project to the XGT Panel. Refer to <2.8.1 Transferring to an XGT Panel> .
The print template file does not exist.	The excel template for printing does not exist. You must create a new template.
The project header information is wrong.	The project header information is corrupt or incorrect.
The project ID is not correct.	The project IDs in XP-Builder and the XGT Panel are different. Transfer the entire project to the XGT Panel. Refer to <2.8.1 Transferring to an XGT Panel> .

Error Message	How to Resolve the Error
The selectable display numbers are from 1 to 4095. Check the number and enter again.	The range of acceptable display numbers has been exceeded. Specify a display number between 1 and 4,095.
The simulator cannot be executed.	The simulator file does not exist. You must create a new simulator file.
The total number of figures should be larger than the number of figures below the decimal point.	Set the total number of figures larger than the number of figures below the decimal point.
The upload file is the same as the opened project file and cannot be saved. Do you want to specify another directory?	You cannot overwrite the project file, because it is open. Click [Yes] to select another destination for the file or [Cancel] to discontinue saving the file. To overwrite the project file, ensure the original file is closed and then try again.
The XGT Panel model does not match the model set in the editor.	This error occurs when you attempt to transfer a project to an XGT Panel model that is not the same as you have set in the project properties. Change the XGT Panel model in the project properties or transfer the project to the same type of panel you have specified in the project properties. Refer to <2.2.2 Viewing and Editing Properties> .
There is no executable file in the device. Send the entire XGT file first.	The executable file has been modified or is incomplete. Transfer the entire project to the XGT Panel.
This is not a 32 bit unsigned data type. Enter a value between 0~4294967295.	If the device size and type is 32 bit decimal, you must set the conditional range between 0 and 4,294,967,295.
This project has an error. Check the tool-data.	Recheck your data and correct any errors before transferring the project.
[Working]/[Engine connection status is in early stage]. Try again.	The XGT Panel is in the operational mode, instead of the update mode. Tap and hold the XGT Panel screen to open the menu. Then, tap [Update HMI Engine] and select the engine download mode.
Wrong display number.	A display with the same number exists or the range of acceptable display numbers has been exceeded. Change the display number.
XGT INI file open error	The initialization file for transferring the XGT Panel engine is missing or in use. Ensure that the initialization file is not in use and try transferring the project again.
XGT model types are not the same.	Change the XGT Panel model in the project properties or transfer the project to a different XGT Panel.
XGT Panel is not ready to receive.	XGT Panel is carrying out another operation. Wait a moment and try again.
You can select only mobile GIF images.	Select a mobile GIF image.

4. Reference

4.1 Common Data

Common data properties apply to the entire project. The following table describes common data types and their limitations.

Type	Description	Limit
Tag	Allows convenient management of devices when you register device addresses and enter tags for commonly-used functions.	10,000 per tag
Text Table	Stores commonly used text. You can invoke text from the text table with various objects.	255 tables 10,001 entries per text table
Logging	Records and saves monitored data in a file.	32 logs Bit: 64, Word: 100
Recipe	Sets write or read values based on the conditions specified.	10,000 device recipes 255 basic recipes/ 65,535 recipe data 5,000 file recipe conditions
Flow Alarm	Streams text across the bottom of the XGT Panel screen when a certain condition is met.	10,000 devices
History Alarm	Saves the device value when a certain condition is met. You can also use this function with the special switch object.	10,000 <ul style="list-style-type: none"> • up to 8 groups at the root • each group supports 4 structure levels (depth 4) • up to 8 child per group
Scheduler	Executes operations at specified times.	32
Script	Controls objects and functions with program commands.	N/A
Sound	Emits sounds from the XGT Panel.	512

4.1.1 Tags

You can use tags to perform various functions. Tags can be used anywhere a device address can be entered and, when you change the value of a tag, the change will be applied to all devices with the same tag.

In the device field, you can enter a tag manually or click the keypad to the right of the field to specify the tag. When you enter a tag name manually, enter “=” as the first character. The checkmark icon will change to a “T” to indicate a tag.



To create a tag:

- 1 In the Project pane, double-click [Tag]. This will open a Tag tab in the editing area.

B-1 Tag *:1						
ID	Group	Name	Device Type	Address	Description	
1	Default	NewTag1	BIT			
2	Default	NewTag2	BIT			
3	Default	NewTag3	BIT			
4	Default	NewTag4	BIT			
5	Default					

- 2 In the **Tag Group** tree, click the **Default** tag group (System tags cannot be edited).
- 3 In the tag list, set the tag name, device type, address, and a description for the tag.

Type	Description
Numbers	A name cannot begin with a number (e.g., “3ABCD”).
Special Character	The following special characters are allowed in the tag names: “_(underscore)”, “%”, “\$”, “#”, “@”, “&”, “*”.
Blank Character	Blank characters before or after the name are not regarded as a part of the tag name.
Device Name	A device address expression cannot be used as a name (e.g., “D0012,” or “%MW123”).
Hexadecimal Number	A hexadecimal number (ex. H234) cannot be used as a name.

Note

- Tag names must be unique. The below table describes rules for tag names.
- All tags are registered on a single table. The changes made to the table affect all the objects where the tag is used.
- Consecutive copying is not performed when you specify a device address with a tag.
- You can double-click the title column in the table to sort the list in ascending or descending order.
- “:”(colon), which is the separator between “group name” and “tag name”, cannot be used for tag name.
- You can insert a row by pressing the Enter key in the name cell of the last row or by using the pop-up menu/drag and drop.

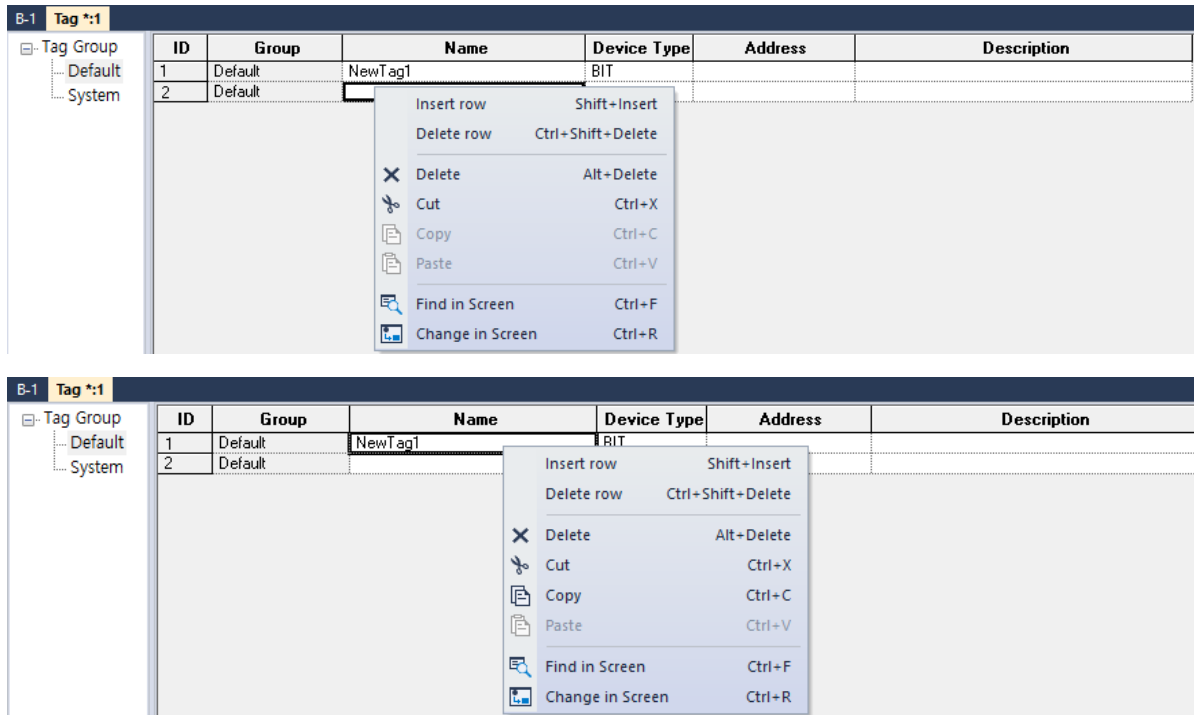

- “Delete row” is possible through the pop-up menu when right-clicking. If the tag is in use, it cannot be deleted.

Two types of tags are available: system tags and user-defined tags. The following table describes the system tags available in XP-Builder.

Name	Type	Device	Description
_NVRAM_Low_Battery	BIT	HS0950.0	The voltage of the XGT Panel battery is low.
_NVRAM_Invalid_Data	BIT	HS0950.1	The XGT Panel’s SRAM memory is damaged.
_No_Logging_Backup_Storage	BIT	HS0951.0	External memory for logging backup is not available.
_No_Recipe_Backup_Storage	BIT	HS0951.1	External memory for recipe backup is not available.
_No_Screen_Backup_Storage	BIT	HS0951.2	External memory for saving the project is not available.
_No_Printer	BIT	HS0951.4	No printer is connected.
_USB_Over_Current_Warning	BIT	HS0950.8	An overcurrent from the connected USB drive was detected.
_No_Alarm_Backup_Storage	BIT	HS0951.3	External memory for alarm backup is not available.
_ON	BIT	HS0000.0	Always contains the value On.
_OFF	BIT	HS0000.1	Always contains the value Off.

Name	Type	Device	Description
_T200MS	BIT	HS0000.6	Alternates between On and Off every 200 milliseconds.
_T1S	BIT	HS0000.7	Alternates between On and Off every second.
_T2S	BIT	HS0000.8	Alternates between On and Off every 2 seconds.
_T5S	BIT	HS0000.9	Alternates between On and Off every 5 seconds.
_T10S	BIT	HS0000.A	Alternates between On and Off every 10 seconds.
_T30S	BIT	HS0000.B	Alternates between On and Off every 30 seconds.
_T60S	BIT	HS0000.C	Alternates between On and Off every 60 seconds.
_SPDEV_RETRY_ABNORMAL_STATION	BIT	HS0517.0	Retry communication for the station number where the communication error occurred.
_SPDEV_COMM00_STATUS_00	WORD	HS2000	In case of XGT Cnet Link, OMRON Link communication, it is the communication status by controller 0 and station number 00~15. Eg. if HS2000.0 = 1, station 0 is abnormal. (HS2000: station 0~15 HS2001: station 16~31 HS2002: station 32~47 HS2003: station 48~63 HS2004: station 64~79 HS2005: station 80~95 HS2006: station 96~111 HS2007: station 112~127 HS2007: station 112~127 HS2008: station 128~143 HS2009: station 144~159 HS2010: station 160~175 HS2011: station 176~191 HS2012: station 192~207 HS2013: station 208~223 HS2014: station 224~239 HS2015: station 240~255)
_SPDEV_COMM01_STATUS_00	WORD	HS2016	In case of XGT Cnet Link, OMRON Link communication, it is the communication status by controller 1 and station number

Name	Type	Device	Description
			00~15.
_SPDEV_COMM02_STATI ON_COMM_STATUS_00	WORD	HS2032	In case of XGT Cnet Link, OMRON Link communication, it is the communication status by controller 2 and station number 00~15.
_SPDEV_COMM03_STATI ON_COMM_STATUS_00	WORD	HS2048	In case of XGT Cnet Link, OMRON Link communication, it is the communication status by controller 3 and station number 00~15.
_SPDEV_COMM04_STATI ON_COMM_STATUS_00	WORD	HS2064	In case of XGT Cnet Link, OMRON Link communication, it is the communication status by controller 4 and station number 00~15.
_SPDEV_COMM05_STATI ON_COMM_STATUS_00	WORD	HS2080	In case of XGT Cnet Link, OMRON Link communication, it is the communication status by controller 5 and station number 00~15.
_SPDEV_COMM06_STATI ON_COMM_STATUS_00	WORD	HS2096	In case of XGT Cnet Link, OMRON Link communication, it is the communication status by controller 6 and station number 00~15.
_SPDEV_COMM07_STATI ON_COMM_STATUS_00	WORD	HS2112	In case of XGT Cnet Link, OMRON Link communication, it is the communication status by controller 7 and station number 00~15.
_SPDEV_COMM08_STATI ON_COMM_STATUS_00	WORD	HS2128	In case of XGT Cnet Link, OMRON Link communication, it is the communication status by controller 8 and station number 00~15.
_SPDEV_COMM09_STATI ON_COMM_STATUS_00	WORD	HS2144	In case of XGT Cnet Link, OMRON Link communication, it is the communication status by controller 9 and station number 00~15.
_SPDEV_COMM10_STATI ON_COMM_STATUS_00	WORD	HS2160	In case of XGT Cnet Link, OMRON Link communication, it is the communication status by controller 10 and station number 00~15.
_SPDEV_COMM11_STATI ON_COMM_STATUS_00	WORD	HS2176	In case of XGT Cnet Link, OMRON Link communication, it is the communication status by controller 11 and station number 00~15.
_SPDEV_COMM12_STATI ON_COMM_STATUS_00	WORD	HS2192	In case of XGT Cnet Link, OMRON Link communication, it is the communication

Name	Type	Device	Description
			status by controller 12 and station number 00~15.
_SPDEV_COMM13_STATI ON_COMM_STATUS_00	WORD	HS2208	In case of XGT Cnet Link, OMRON Link communication, it is the communication status by controller 13 and station number 00~15.
_SPDEV_COMM14_STATI ON_COMM_STATUS_00	WORD	HS2224	In case of XGT Cnet Link, OMRON Link communication, it is the communication status by controller 14 and station number 00~15.
_SPDEV_COMM15_STATI ON_COMM_STATUS_00	WORD	HS2240	In case of XGT Cnet Link, OMRON Link communication, it is the communication status by controller 15 and station number 00~15.
_OSVER_MAJ	WORD	HS0001	Display the OS version info (Major) of the XGT Panel.
_OSVER_MIN	WORD	HS0002	Display the OS version info (Minor) of the XGT Panel.
_YEAR	WORD	HS0004	Time info [Year] for the XGT Panel.
_MON	WORD	HS0005	Time info [Month] for the XGT Panel.
_DAY	WORD	HS0006	Time info [Day] for the XGT Panel.
_HOUR	WORD	HS0007	Time info [Hour] for the XGT Panel.
_MIN	WORD	HS0008	Time info [Minute] for the XGT Panel.
_SEC	WORD	HS0009	Time info [Second] for the XGT Panel.
_BASESCREEN_NO	WORD	HS0010	Display the number of the current Base screen.
_GLOBALWNG1_NO	WORD	HS0011	Display the number of the #1 global window.
_GLOBALWNG2_NO	WORD	HS0012	Display the number of the #2 global window.
_SECURITY_NO	WORD	HS0013	Display a defined security level.
_ZERO	WORD	HS0014	Always contain the value of zero.
_C500MS	WORD	HS0015	Increase value by 1 every 500 milliseconds.
_C1S	WORD	HS0016	Increase value by 1 every second.
_C2S	WORD	HS0017	Increase value by 1 every 2 seconds.
_C5S	WORD	HS0018	Increase value by 1 every 5 seconds.

Name	Type	Device	Description
_C10S	WORD	HS0019	Increase value by 1 every 10 seconds.
_Change_to_Screen	WORD	HS0500	The device to change the Base screen (operates in window change mode).
_DAY_OF_WEEK	WORD	HS0003	Time info [Day of week] for the XGT Panel (Sun=0 to Sat=6).
_T50MS	BIT	HS0000.4	Alternates between On and Off every 50 milliseconds.
_T100MS	BIT	HS0000.5	Alternates between On and Off every 100 milliseconds.
_T500MS	BIT	HS0000.F	Alternates between On and Off every 500 milliseconds.
_No_Memo_Backup_Storage	BIT	HS0951.5	No external backup memory available.
_XPLinkParam_Load_Error	BIT	HS0100.2	Failed to process the parameter uploaded from XP-Manager.
_XP_VNC_Seaver_ON	BIT	HS0100.1	XP-VNC server is running.
_Web_Seaver_ON	BIT	HS0100.2	Web server is running.
_Size_All_Flash_Low	WORD	HS0027	The total flash memory capacity (low-order, double word).
_Size_All_Flash_High	WORD	HS0029	The total flash memory capacity (high-order, double word).
_Size_Available_Flash_Low	WORD	HS0031	The available flash memory capacity (low-order, double word).
_Size_Available_Flash_High	WORD	HS0033	The available flash memory capacity (high-order, double word).
_Size_All_USB_Low	WORD	HS0035	The total USB memory capacity (low-order, double word).
_Size_All_USB_High	WORD	HS0037	The total USB memory capacity (high-order, double word).
_Size_Available_USB_Low	WORD	HS0039	The available capacity of USB storage (Low-order, double word).
_Size_Available_USB_High	WORD	HS0041	The available capacity of USB memory (High-order, double word).
_Size_All_CF_Low	WORD	HS0043	The total CF card memory capacity (low-order, double word).
_Size_All_CF_High	WORD	HS0045	The total CF card memory capacity (high-order, double word).

Name	Type	Device	Description
_Size_Available_CF_Low	WORD	HS0047	The available CF card memory capacity (low-order, double word).
_Size_Available_CF_High	WORD	HS0049	The available CF card memory capacity (high-order, double word).
_USB_Attached	BIT	HS0051.0	Display whether or not the USB storage device is connected.
_CF_Attached	BIT	HS0051.1	Display whether or not the CF card is connected.
_N1_Token	BIT	HS0070.0	Connected with a token during N: 1 communication.
_N1_Token_Hold	BIT	HS0501.0	Set the panel to hold the token for a specified time.
_N1_Token_Station	WORD	HS0071	Display the station number of the node holding the token during N: 1 communication.
_IDLE_TIME_COUNTER	WORD	HS0502	Increase the count every second that you do not touch the panel or use the mouse pointer.
_XP_VNC_INTERLOCK	BIT	HS0503.0	When turned on, a user connected via XP-VNC cannot make inputs with a mouse or keyboard.
_N1_Token_Count	WORD	HS0072	Display the acquired number of the token during N: 1 communication.
_N1_Station	WORD	HS0073	Display the station number of the XGT Panel during N: 1 communication.
_1_ON	BIT	HS0000.D	Set to turn on the first time devices are scanned. The tag is skipped on subsequent scans. You can use this tag to initialize a program.
_Enable_XP_Remote	BIT	HS0504.0	Display whether or not the device can be operated with XP-Remote.
_Has_Ctrl_Right	BIT	HS0075.0	Display whether or not the XGT Panel has the right to operate. If XP-Remote has the right, it turns off.
_XP_Remote_Count	WORD	HS0076	Display the number of XP-Remote instances that are connected to an XGT Panel.
_Ctrl_Right_XP_Remote_ID	WORD	HS0077	Display the ID of an XP-Remote instance that has the right to operate.
_Ctrl_Right_XP_Remote_IP	WORD	HS0078	Display the IP address of an XP-Remote

Name	Type	Device	Description
			instance that has the right to operate (32-bit).
_RS232C_Over_Current_Warning	BIT	HS0950.9	Overcurrent detected in an XGT Panel from a PLC connected via RS-232C (only for the iXP series).
_VM_Mod_Over_Current_Warning	BIT	HS0950.A	Overcurrent detected in an XGT Panel from a PLC connected via the VM module (only for the iXP series).
_EXT_Mod_Over_Current_Warning	BIT	HS0950.B	Overcurrent detected in an XGT Panel from a PLC connected via the expanded mode (only for the iXP series).
_No_Sound_File_Storage	BIT	HS0951.8	No external memory for saving the sound file is available.
_SD_Attached	BIT	HS0051.2	Display whether or not the SD card is connected.
_Size_All_SD_Low	WORD	HS0058	The total SD card memory capacity (low-order, double word).
_Size_All_SD_High	WORD	HS0060	The total SD card memory capacity (high-order, double word).
_Size_Available_SD_Low	WORD	HS0062	The available SD card memory capacity (low-order, double word).
_Size_Available_SD_High	WORD	HS0064	The available SD card memory capacity (high-order, double word).
_Alarm_Norecovery_Device_Num	WORD	HS0093	Device shows number of unrecovered alarms.
_Alarm_Norconfirm_Device_Num	WORD	HS0084	Device shows number of unconfirmed alarms.
_BARCODE_SAVEIN_KEY_CODE	BIT	HS0501.2	Save keyboard input to barcode device
_BARCODE_INITIAL_TIME	WORD	HS0507	Wait timeout for storing keyboard input data.
_XP_VNC_Server_Control	BIT	HS0503.1	VNC Server Control
_CONTROLLER0_IP_LOWER	WORD	HS0944	Controller0 IP lower address
_CONTROLLER0_IP_UPPER	WORD	HS0945	Controller0 IP upper address
_HMI_LAN0_IP_LOWER	WORD	HS0140	HMI LAN0 IP lower address
_HMI_LAN0_IP_UPPER	WORD	HS0141	HMI LAN0 IP upper address

Name	Type	Device	Description
_HMI_LAN1_IP_LOWER	WORD	HS0142	HMI LAN1 IP lower address
_HMI_LAN1_IP_UPPER	WORD	HS0143	HMI LAN1 IP upper address
_SPDEV_START_RUN_TIME_GSCRIPT	BIT	HS0501.1	Whether to use the global script debug function.
_SPDEV_RUN_TIME_ALL_GSCRIPT	WORD	HS0253	Maximum 1 scan time for Global Script's condition check and execution.
_SPDEV_RUN_TIME_GSCRIPT_1	WORD	HS0221	Maximum time for global script no.1 execution.
_SPDEV_RUN_TIME_GSCRIPT_2	WORD	HS0222	Maximum time for global script no.2 execution.
_SPDEV_RUN_TIME_GSCRIPT_3	WORD	HS0223	Maximum time for global script no.3 execution.
_SPDEV_RUN_TIME_GSCRIPT_4	WORD	HS0224	Maximum time for global script no.4 execution.
_SPDEV_RUN_TIME_GSCRIPT_5	WORD	HS0225	Maximum time for global script no.5 execution.
_SPDEV_RUN_TIME_GSCRIPT_6	WORD	HS0226	Maximum time for global script no.6 execution.
_SPDEV_RUN_TIME_GSCRIPT_7	WORD	HS0227	Maximum time for global script no.7 execution.
_SPDEV_RUN_TIME_GSCRIPT_8	WORD	HS0228	Maximum time for global script no.8 execution.
_SPDEV_RUN_TIME_GSCRIPT_9	WORD	HS0229	Maximum time for global script no.9 execution.
_SPDEV_RUN_TIME_GSCRIPT_10	WORD	HS0230	Maximum time for global script no.10 execution.
_SPDEV_RUN_TIME_GSCRIPT_11	WORD	HS0231	Maximum time for global script no.11 execution.
_SPDEV_RUN_TIME_GSCRIPT_12	WORD	HS0232	Maximum time for global script no.12 execution.
_SPDEV_RUN_TIME_GSCRIPT_13	WORD	HS0233	Maximum time for global script no.13 execution.
_SPDEV_RUN_TIME_GSCRIPT_14	WORD	HS0234	Maximum time for global script no.14 execution.
_SPDEV_RUN_TIME_GSCRIPT_15	WORD	HS0235	Maximum time for global script no.15 execution.
_SPDEV_RUN_TIME_GSCRIPT_16	WORD	HS0236	Maximum time for global script no.16 execution.

Name	Type	Device	Description
_SPDEV_RUN_TIME_GSC RIPT_17	WORD	HS0237	Maximum time for global script no.17 execution.
_SPDEV_RUN_TIME_GSC RIPT_18	WORD	HS0238	Maximum time for global script no.18 execution.
_SPDEV_RUN_TIME_GSC RIPT_19	WORD	HS0239	Maximum time for global script no.19 execution.
_SPDEV_RUN_TIME_GSC RIPT_20	WORD	HS0240	Maximum time for global script no.20 execution.
_SPDEV_RUN_TIME_GSC RIPT_21	WORD	HS0241	Maximum time for global script no.21 execution.
_SPDEV_RUN_TIME_GSC RIPT_22	WORD	HS0242	Maximum time for global script no.22 execution.
_SPDEV_RUN_TIME_GSC RIPT_23	WORD	HS0243	Maximum time for global script no.23 execution.
_SPDEV_RUN_TIME_GSC RIPT_24	WORD	HS0244	Maximum time for global script no.24 execution.
_SPDEV_RUN_TIME_GSC RIPT_25	WORD	HS0245	Maximum time for global script no.25 execution.
_SPDEV_RUN_TIME_GSC RIPT_26	WORD	HS0246	Maximum time for global script no.26 execution.
_SPDEV_RUN_TIME_GSC RIPT_27	WORD	HS0247	Maximum time for global script no.27 execution.
_SPDEV_RUN_TIME_GSC RIPT_28	WORD	HS0248	Maximum time for global script no.28 execution.
_SPDEV_RUN_TIME_GSC RIPT_29	WORD	HS0249	Maximum time for global script no.29 execution.
_SPDEV_RUN_TIME_GSC RIPT_30	WORD	HS0250	Maximum time for global script no.30 execution.
_SPDEV_RUN_TIME_GSC RIPT_31	WORD	HS0251	Maximum time for global script no.31 execution.
_SPDEV_RUN_TIME_GSC RIPT_32	WORD	HS0252	Maximum time for global script no.32 execution.
_SPDEV_RUN_TIME_SC_ SCRIPT_1	WORD	HS0261	Maximum time for local script no.1 execution.
_SPDEV_RUN_TIME_SC_ SCRIPT_2	WORD	HS0262	Maximum time for local script no.2 execution.
_SPDEV_RUN_TIME_SC_ SCRIPT_3	WORD	HS0263	Maximum time for local script no.3 execution.

Name	Type	Device	Description
_SPDEV_RUN_TIME_SC_SCRIPT_4	WORD	HS0264	Maximum time for local script no.4 execution.
_SPDEV_RUN_TIME_SC_SCRIPT_5	WORD	HS0265	Maximum time for local script no.5 execution.
_SPDEV_RUN_TIME_SC_SCRIPT_6	WORD	HS0266	Maximum time for local script no.6 execution.
_SPDEV_RUN_TIME_SC_SCRIPT_7	WORD	HS0267	Maximum time for local script no.7 execution.
_SPDEV_RUN_TIME_SC_SCRIPT_8	WORD	HS0268	Maximum time for local script no.8 execution.
_SPDEV_RUN_TIME_SC_SCRIPT_9	WORD	HS0269	Maximum time for local script no.9 execution.
_SPDEV_RUN_TIME_SC_SCRIPT_10	WORD	HS0270	Maximum time for local script no.10 execution.
_SPDEV_RUN_TIME_SC_SCRIPT_11	WORD	HS0271	Maximum time for local script no.11 execution.
_SPDEV_RUN_TIME_SC_SCRIPT_12	WORD	HS0272	Maximum time for local script no.12 execution.
_SPDEV_RUN_TIME_SC_SCRIPT_13	WORD	HS0273	Maximum time for local script no.13 execution.
_SPDEV_RUN_TIME_SC_SCRIPT_14	WORD	HS0274	Maximum time for local script no.14 execution.
_SPDEV_RUN_TIME_SC_SCRIPT_15	WORD	HS0275	Maximum time for local script no.15 execution.
_SPDEV_RUN_TIME_SC_SCRIPT_16	WORD	HS0276	Maximum time for local script no.16 execution.
_SPDEV_RUN_TIME_SC_SCRIPT_17	WORD	HS0277	Maximum time for local script no.17 execution.
_SPDEV_RUN_TIME_SC_SCRIPT_18	WORD	HS0278	Maximum time for local script no.18 execution.
_SPDEV_RUN_TIME_SC_SCRIPT_19	WORD	HS0279	Maximum time for local script no.19 execution.
_SPDEV_RUN_TIME_SC_SCRIPT_20	WORD	HS0280	Maximum time for local script no.20 execution.
_SPDEV_RUN_TIME_SC_SCRIPT_21	WORD	HS0281	Maximum time for local script no.21 execution.
_SPDEV_RUN_TIME_SC_SCRIPT_22	WORD	HS0282	Maximum time for local script no.22 execution.

Name	Type	Device	Description
_SPDEV_RUN_TIME_SC_SCRIPT_23	WORD	HS0283	Maximum time for local script no.23 execution.
_SPDEV_RUN_TIME_SC_SCRIPT_24	WORD	HS0284	Maximum time for local script no.24 execution.
_SPDEV_RUN_TIME_SC_SCRIPT_25	WORD	HS0285	Maximum time for local script no.25 execution.
_SPDEV_RUN_TIME_SC_SCRIPT_26	WORD	HS0286	Maximum time for local script no.26 execution.
_SPDEV_RUN_TIME_SC_SCRIPT_27	WORD	HS0287	Maximum time for local script no.27 execution.
_SPDEV_RUN_TIME_SC_SCRIPT_28	WORD	HS0288	Maximum time for local script no.28 execution.
_SPDEV_RUN_TIME_SC_SCRIPT_29	WORD	HS0289	Maximum time for local script no.29 execution.
_SPDEV_RUN_TIME_SC_SCRIPT_30	WORD	HS0290	Maximum time for local script no.30 execution.
_SPDEV_RUN_TIME_SC_SCRIPT_31	WORD	HS0291	Maximum time for local script no.31 execution.
_SPDEV_RUN_TIME_SC_SCRIPT_32	WORD	HS0292	Maximum time for local script no.32 execution.
_SPDEV_START_RUN_TIME_SC_SCRIPT	BIT	HS0501.3	Whether to use local script debug function.

To set a tag as a device address:

- 1 Double-click on an object to open the properties window.
- 2 In the device field, enter a tag manually or click the keypad to the right of the field to specify the tag. When you enter a tag name manually, enter “=” as the first character. The checkmark icon will change to a “T” to indicate a tag.



- 3 Check the checkbox next to **Tag**.

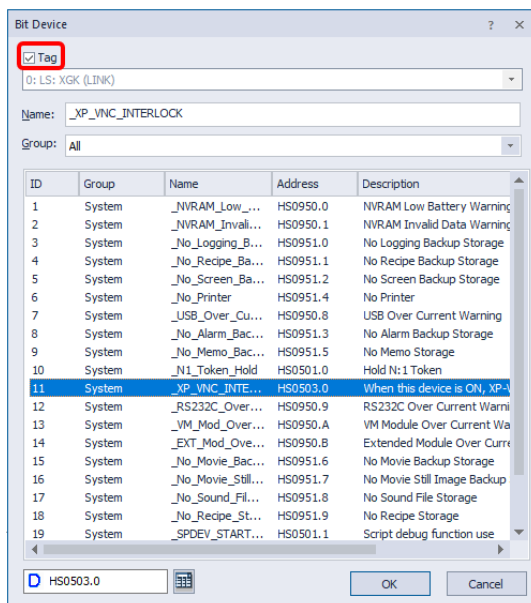

4 Select a tag group and a tag. You can view the available tag list.

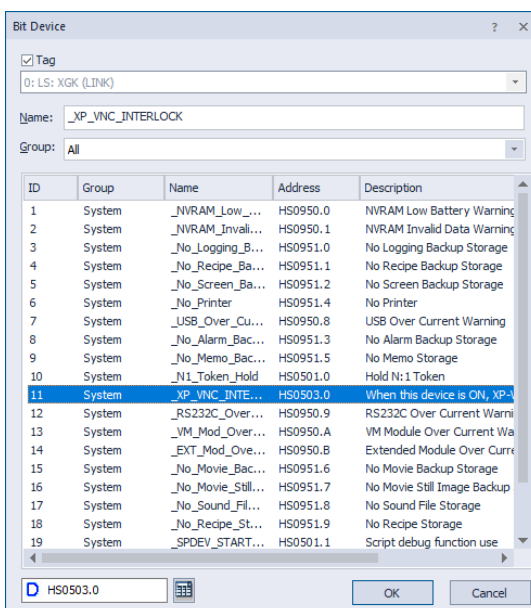

5 Click [OK]. The tag icon will appear in the device field.

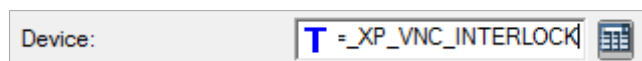

Note

- When registering a new tag, enter “ = ” in front of the tag name to be registered and enter it in the device address window to register a new tag. If the tag group is not “Default” or “System”, the group name must be entered together in the address window, such as “Group Name” + “ : ” + “Tag Name”.

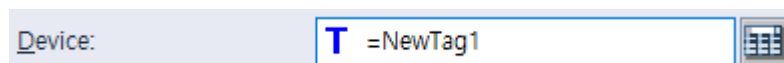

- Changing the tag type (bit or word) can cause errors.
- You can change the tag address in the edit box at the bottom of the tag dialog box. The address changes when the focus of the cursor is released in the edit box.

To delete a tag:

1 Select tags in the tag table.

No	Group	Name	Device Type	Address	Description
1	Default	Line1	BIT	P00001	
2	Default	Line2	BIT	P00002	
3	Default	Line3	WORD	P0004	
4	Default				
5	Default				

2 Press the Delete key on the keyboard.

However, if the tag is used in the project, the following message is displayed and it is not deleted. In this case, you must use Find / Change to find the object or element being used in the system to delete the tag or delete after changing the tag.

With XG5000 software, you can export all the tags used in a project, and then import them into XP-Builder.

To import a file of tags from the XG5000:

1 Right-click a tag group.

2 Click [Import XG5000 Variable].

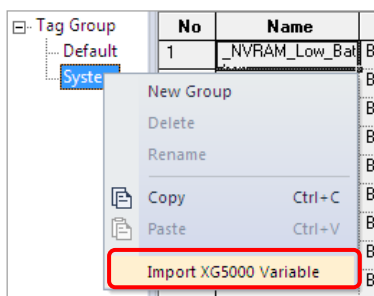

3 Click and open a file containing tag data (*.csv).

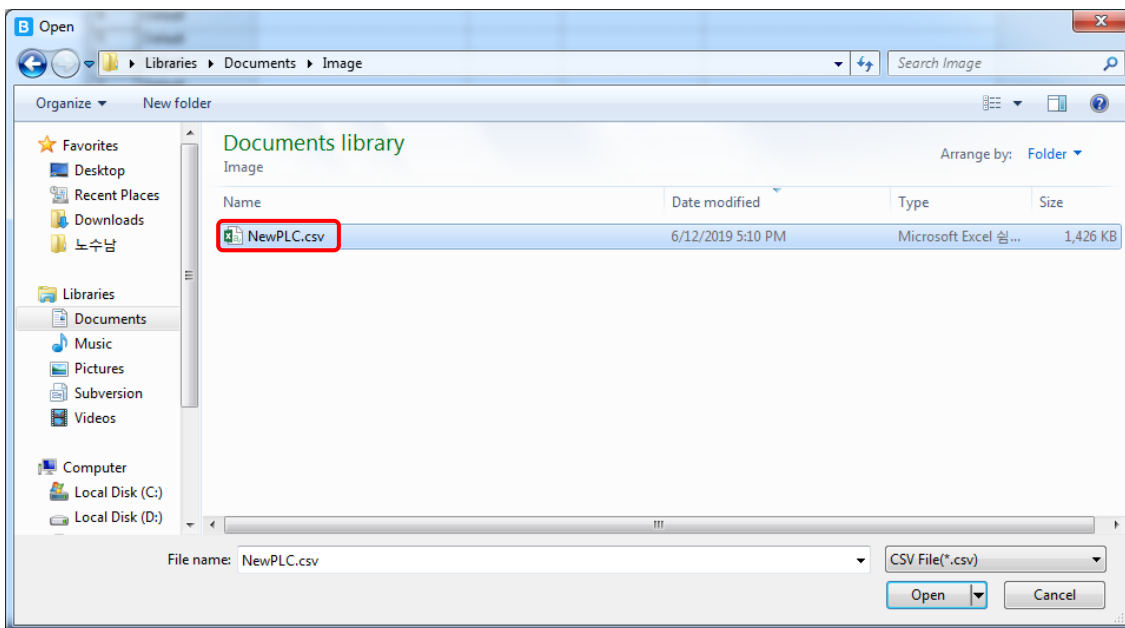

4 Click [Open].

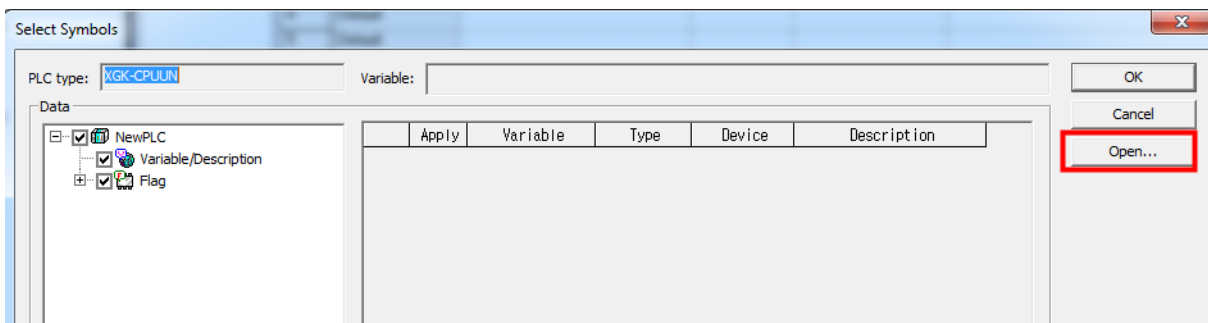

- This will create a new tag group (“NewPLC”).

ID	Group	Name	Device Type	Address	Description	Device[XT5000]	I
1	NewPLC	First	BIT	M00000	first device	M00000	BIT
2	NewPLC	four	BIT	M00003	four	M00003	BIT
3	NewPLC	Seconed	BIT	M00001	Seconed device	M00001	BIT
4	NewPLC	Three	BIT	M00002	Three device	M00002	BIT
5	NewPLC						

Note

- Follow the instructions to export tag data to a CSV file.
 1. Run an XG5000 program of version 3.0 or higher.
 2. Click [Project] ► [Save as Variables/Comment].
 3. Select the variables and click [OK].

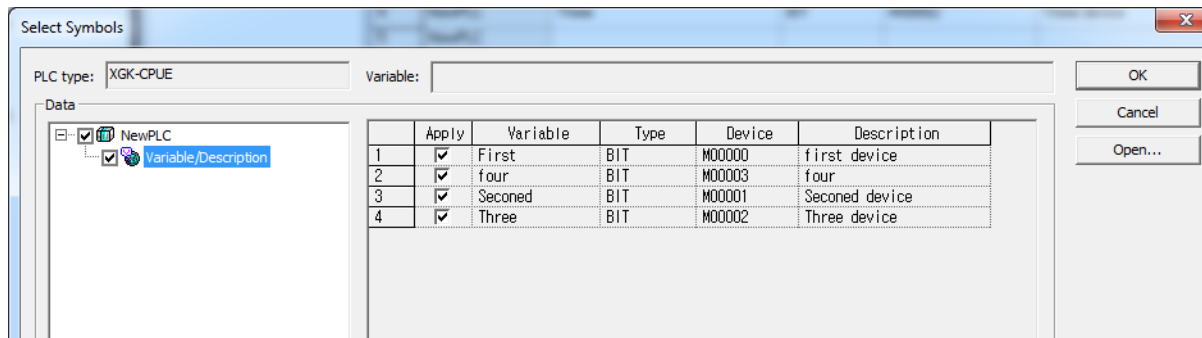

- If the PLC type is different when you import the data, an error will occur.
- Other than bit and word devices are not imported properly.

4.1.2 Text Tables

Text tables allow you to store and manage text for reuse, translation, and simplified management. The advantage of using text tables is that you can register text strings and then use them throughout the project. For example, you can fetch text from a text table to use as an object caption and format the color, size, and other font properties. You can also create multilingual interfaces by adding language columns to the text table and registering translations for the text strings.

The following are examples of text table applications for bit and word messages based on the device conditions.

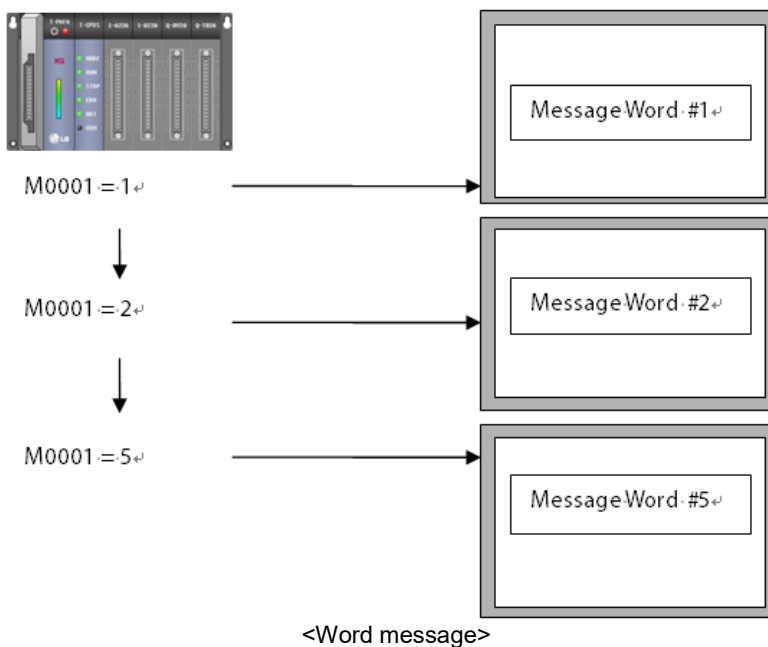
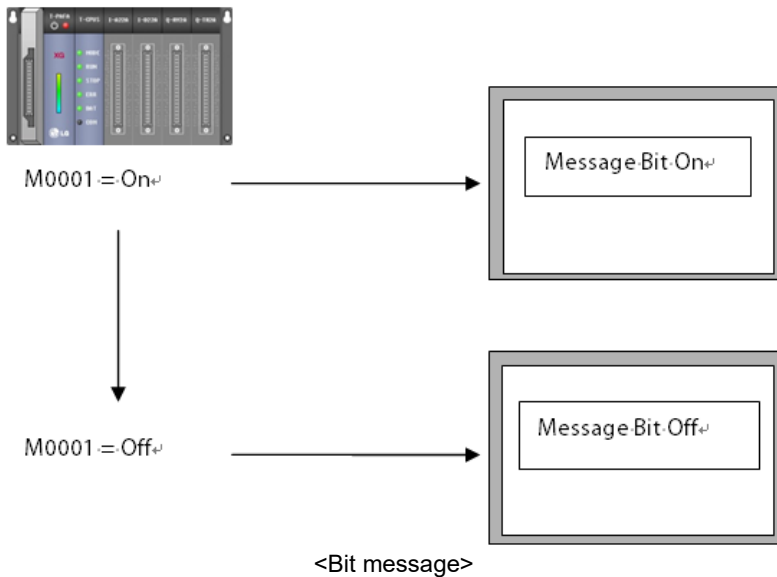

To create a text table:

- 1 In the Project pane, right-click [Text Table].
- 2 Click [Insert].

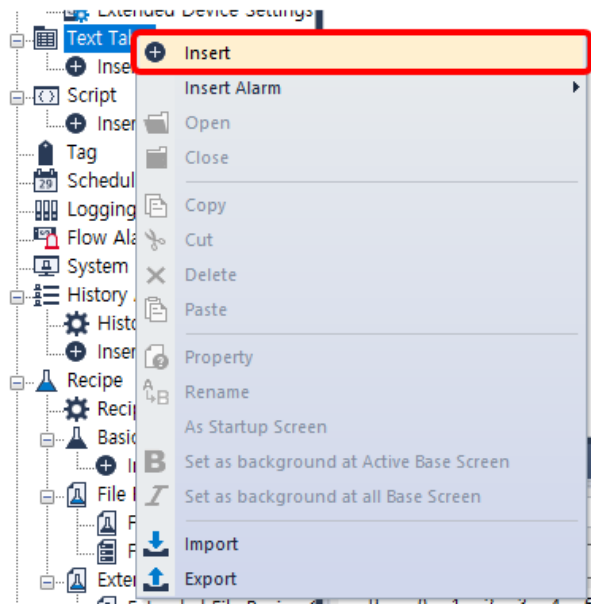

- 3 Enter text and set properties, such as font color and typeface.

No	English (United States)	Color	Italic	Underline	StrikeOut	Bold
0	Object Sample1		Off	On	On	Off
1						

Note

- Window title: When a string for a window title is taken from a text table, text properties of the text string in the table, such as font size, colors, and other text styles (italic, underlined, bold, etc.), are ignored. The selected string is displayed in the title section of the window in white 15 px characters.
 - Sorting the text table: You can double-click the title column in the table (except for the color column) to sort the list in ascending or descending order.
-
- When you enter text in a text table, the text appears in the language currently set in the project properties.

To specify languages in a text table:

- 1 In the Project pane, double-click a text table to open it.
- 2 Right-click anywhere in the text table and click [Property].

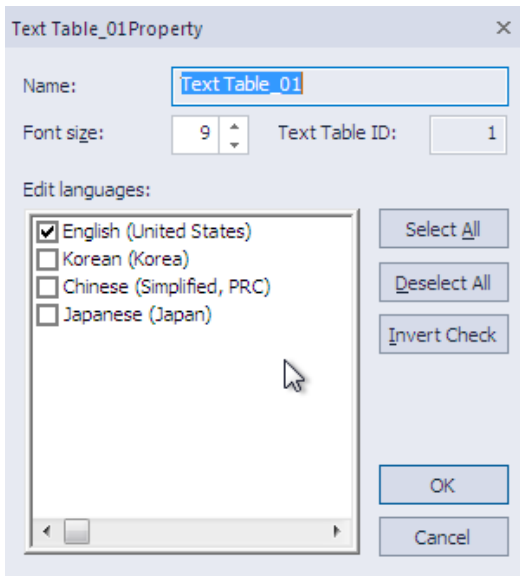

- 3 Click languages from the language list and then click [OK]. Columns for alternate text will be added for as many languages as you select in the language list.

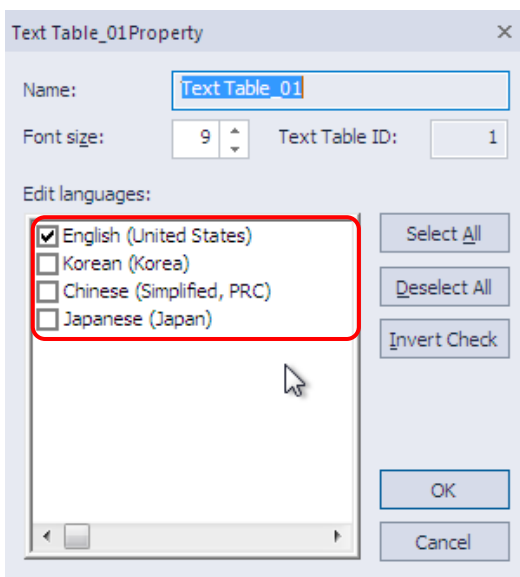

No	English (United States)	Korean (Korea)	Color	Italic	Underline	StrikeOut	Bold
0	Line #1	라인 #1		Off	On	On	Off

- 4 Enter the translation of the string in the appropriate field.

No	English (United States)	Korean (Korea)	Color	Italic	Underline	StrikeOut	Bold
0	Line #1	라인 #1		Off	On	On	Off

- It will be available for display in objects when the user selects the alternative language from the drop-down list on the XP-Builder toolbar. To add additional languages to the list of supported languages, refer to **<2.2.2.6 Changing Languages>**.





Note

To support multiple languages, the operating system you are using must support the language as well.

To apply text from a text table:

- 1 Create an object that supports the use of text tables (see the table that follows).
- 2 Click [Text] in the object property window or click [Header] for a History Alarm Viewer object. To apply the text table to a Flow Alarm or History Alarm, select one of the text tables from the **Text Table Name** field in the Flow Alarm editing area or the **Text Table** field in the History Alarm editing area.
- 3 Select a text table:

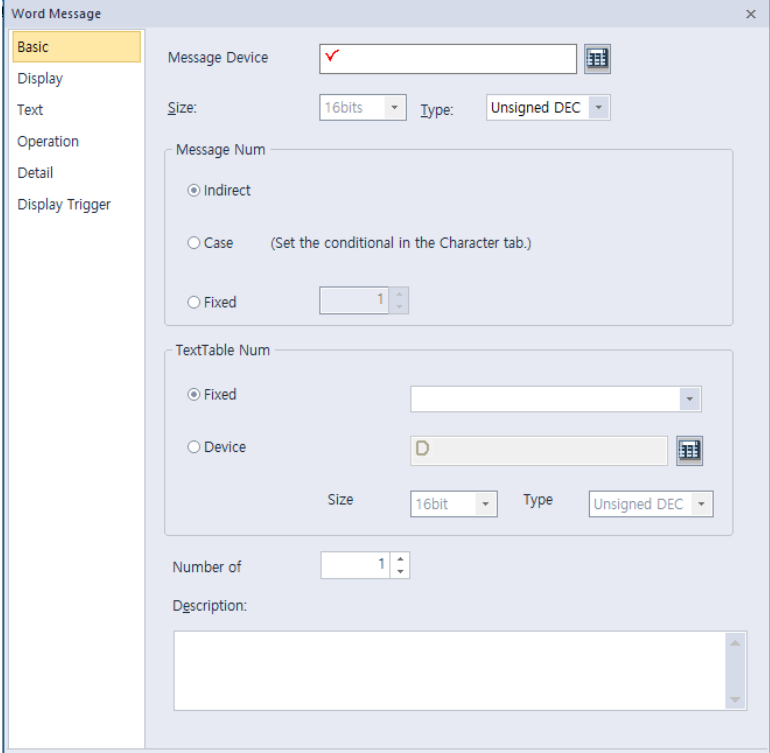
Type	Description
Bit Message	<p>Click [On] or [Off] ► [Text Table].</p>
Word Message	<p>Select the message on Basic tab. [Message Device]: Selecting message number on the text table to display. - Indirect: Displays message of the number corresponding to the device value on the text table. - Case: Displays message that meets the conditions set in the Text</p>

Type	Description
	<p>tab.</p> <ul style="list-style-type: none"> - Fixed: Displays the message on the text table selected. - Device: Select the text table corresponding to the device value. 
<ul style="list-style-type: none"> Bit Switch Word Switch Change Screen Switch Special Switch Multi Switch Bit Lamp Word Lamp N-State Lamp History Alarm Viewer 	<p>Check the checkbox next to Use Caption, check the checkbox next to From Text Table, and then click [Text Table].</p>  <p>Click [From Text Table in Header Edit] and double-click the Title area.</p>

4 Select a text string (if necessary).

Note

You can set the text to appear differently based on the value of the device.

You can automatically add object captions to a text table.

To create a text table of captions:

- 1 Create objects with text captions on the editing area.
- 2 Click [Tool] ► [Register Object Caption to Text Table Automatically].

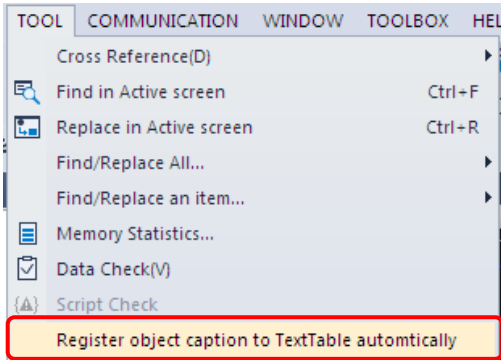

- 3 Enter a name for the text table, select an editing language, and click [OK]. The text table will appear in the Project pane.

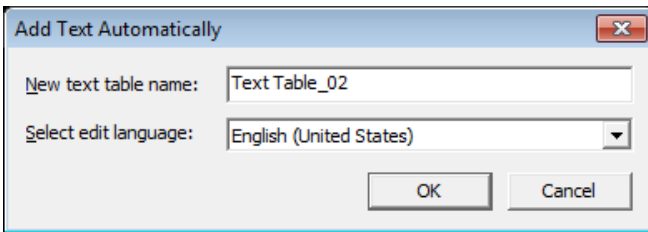

- You can double-click the name of the text table in the Project pane to ensure that the captions have been listed on the text table.

No	English (United States)	Korean (Korea)	Color	Italic	Underline	StrikeOut	Bold
0							
1	Take2			On	Off	Off	Off
2	Take1			Off	Off	Off	On

Note

- Up to 10,001 strings can be registered to the text table. To add more than 10,001 entries, you must create a new text table.
- A total of 255 string pages can be created in the Text table, and IDs and names can be changed directly on the tree. The ID is from 1 to 65534 (1 to 255 for economic type).
- If the following message appears when you delete the text table page from the tree or change the ID, it means that the table is being used in the project. In this case, you need to first find out the elements used for deletion by Find/Replace All, or change them to a text table with a different ID.

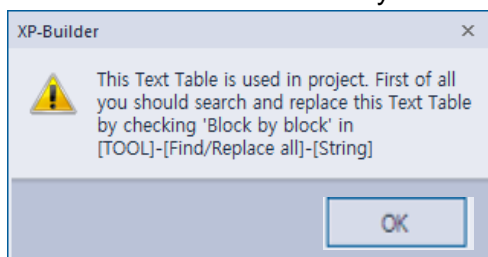

4.1.3 Logging

You can use up to 32 logs to record and save device values to a file when specified conditions are met. Logging can be used to trace device trends. You can view the logs in the Logging Viewer or Logging Trend Graph object. Refer to **<4.3.11 Logging Viewer Object>** for detailed information.

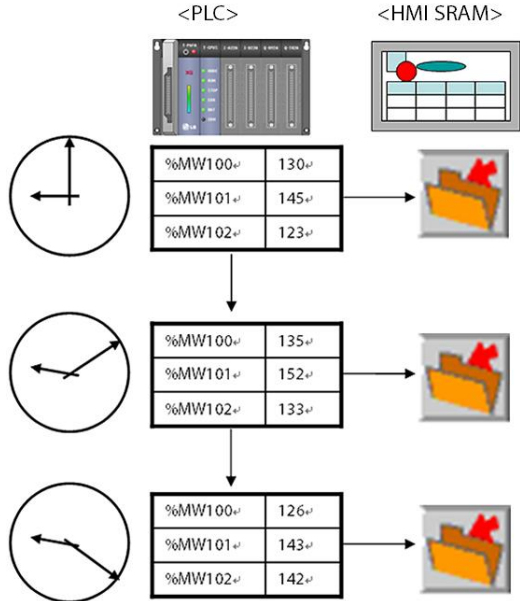
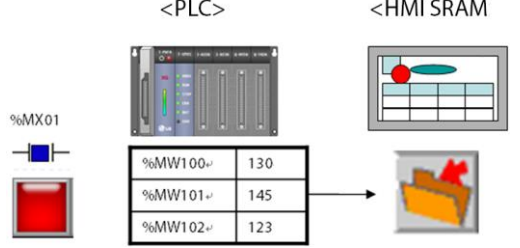
Type	Description
Periodical Logging (Time)	<p>Logging starts on a specified schedule and is repeated periodically, as specified in the scheduler. The log can repeat up to 100 times. When the repetition timer reaches the specified limit, the device values are saved in the file.</p> <p>The example below shows three logging data in 10-minute intervals.</p> <div style="text-align: center;">  </div>
Periodical Logging (Bit Device)	<p>When the logging device turns on, logging begins. You can set the logging intervals and repetition numbers.</p>
Conditional Logging (Bit Device)	<p>Logging begins when the logging device is changed, or when it is turned on or off. Logging does not repeat, unless the device is changed, or it is turned on or off again.</p> <div style="text-align: center;">  </div>

To create a log:

1 In the Project pane, double-click [Logging]. This will open a Logging tab in the editing area.

No	Condition	Repeat Count	Repeat Period	Device	Device Count
1	Every hour at 50m	1	00:00:10	P0123	1
2					
3					
4					
5					
6					

2 Double-click anywhere in a field to specify the following settings.

• **Logging Device:**

Function	Description
No.	The number of the log.
Target Device	Specify the device to read. Enter the device address manually or click the keypad to the right of the field to specify a device.
Device Count	Specify the number of devices to read consecutively from the start device <ul style="list-style-type: none"> - In case of target device is Bit: maximum of 64 bits - In case of target device is word: maximum 100 words.
Description	Enter a description for the logging process.

• **Logging Condition:**

Function	Description
Period	Specify a period for logging: every hour, every day, every week, every month, or once. Use the dropdown menu to set a specific operating interval. For example, if you select “Every hour”, you can set the specific minute when the logging will occur. If you do not specify the minute, the logging will occur every hour, on the hour.
Device (BIT)	Specify a bit device and condition to trigger periodic logging (rising edge or falling edge).
Repeat By	Set the number of repetitions for the logging operation (max. 255 times). The starting point for repeating the logging operation is when the device condition is met.
Repeat Period	Set the file recording cycle, if logging conditions are met.
Device(BIT) from Conditional Logging	Specify a bit device and condition to trigger conditional logging (rising edge, falling edge, or on change).
Logging Progress	Specify the device that will display the logging process. The bit device stays turned on until the cycle is completed.
Stop Logging	Specify a device to stop logging. Logging stops when the specified devices turns on. Once logging stops, it does not continue on the next cycle or repetition. The stop logging device operates on the rising edge.
Logging Area Full	Specify a device to activate when the storage area (NVRAM) for logging data is full.
Clear Logging Area	Specify a device to clear the storage area for logging data. When the device turns on, data in the specified area is

Function	Description
Logging Area Clear Complete	deleted. Specify a device to activate when data in the storage area for logging data is deleted.

Note

- If you set the periodic logging setting to Period, you can set the logging to repeat up to 255 times. Logging starts at the time you set and repeats as many times as specified at the designated period.
- If you set the periodic logging setting to Device (Bit Device), logging starts when the bit device is turned on or off and repeats as many times as specified at the designated period.

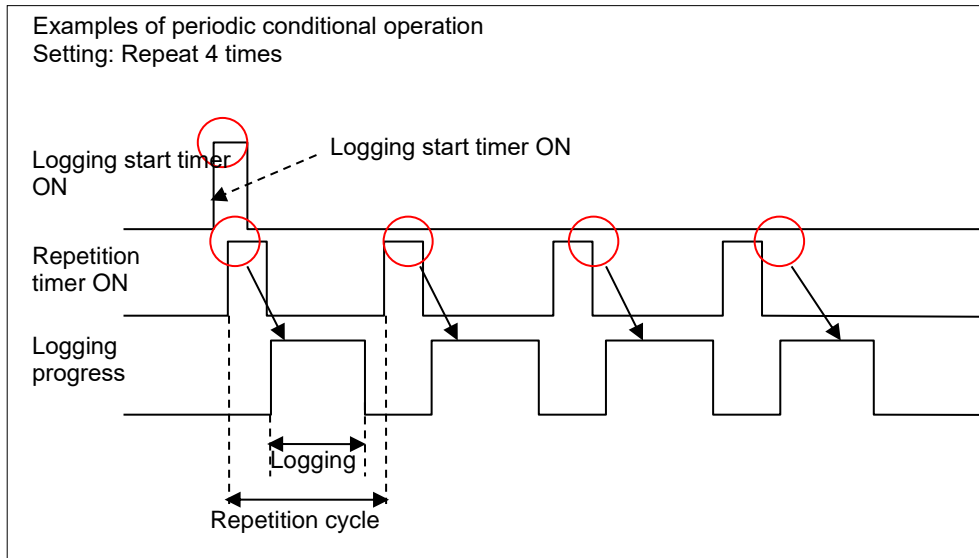

- **Backup Area/Buffer Manage/Backup CSV Format:**

The screenshot shows the 'Logging' dialog box with the 'Backup Area/Buffer Manage/Backup CSV Format' tab selected. The settings are as follows:

- Storage for backup data:** USB memory (dropdown), Logging (text box)
- Logging Area:**
 - Use ring buffer
 - Do not clear log area at backup
 - Auto backup if area full
- Backup Device:**
 - File type: CSV file, Encrypted CSV file, CSV + PDF
 - Backup device: [red checkmark] [device icon]
 - Send E-mail after backup done
 - Complete device: [red checkmark] [device icon] [Setting CSV file format button]
 - File name device: [D] [device icon]
 - BYTE swap of file name
 - Cycle Unit Backup Mode: [Every month] [dropdown]
 - File name length: [8] [spinners] bytes
 - Append data to CSV file
 - File Generation as Date/Time Folder structure
 - Create Logging No. Directory

Function	Description
Storage for Backup Data	Set a storage area for logging backup data. Refer to <4.7.1.1 File Path for Logging Backup> for detailed information about storing backup files.
Use Ring Buffer	Set this option to overwrite logging data when the storage area is full. Otherwise logs cannot be saved even if the condition is met. Overwriting occurs from the oldest file.

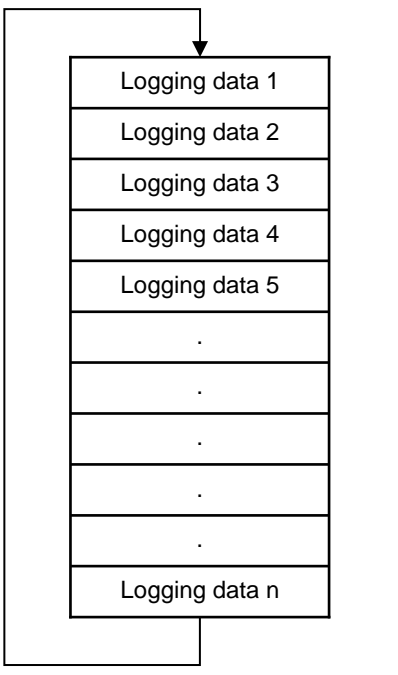
Function	Description
	<p data-bbox="539 369 738 504">Storage location is shifted and the logging data is recorded from the first space.</p>  <p data-bbox="499 1025 1369 1093">This option cannot be used in conjunction with the Auto backup if area full option.</p>
Do Not Clear Log Area at Backup	<p data-bbox="499 1120 1332 1350">Set to retain logging data when data is backed up to the area specified in the project properties. When logging data is backed up, the data in the internal memory is deleted. However, some specific objects, such as the logging trend object, need to retain data even though it is backed up. At this time, set this option to retain the data. If you set this option, the logging area setting is changed to Use Ring Buffer automatically.</p>
Auto Backup if Area Full	<p data-bbox="499 1377 1369 1574">Set to back up logging data automatically when the storage area for logging data is full. This option cannot be used in conjunction with the Use ring buffer option. When the storage for logging data is full, it is backed up to the specified location. After backup, the data is deleted, and then the new data is saved from the first space.</p>

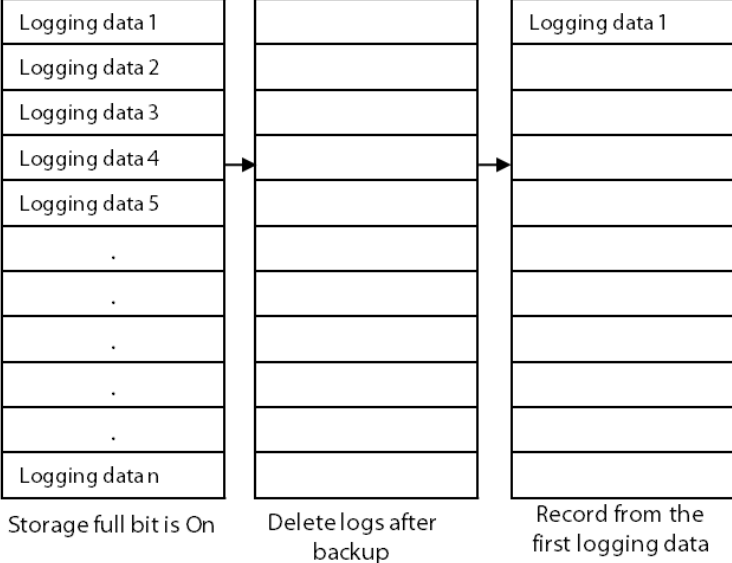
Function	Description
	 <p>Storage full bit is On Delete logs after backup Record from the first logging data</p>
Backup Device	Specify a device to trigger the backing up of logging data.
Send E-mail after Backup Done	Set to send an email when logging data is backed up.
Complete Device	Specify a device to activate when logging data is backed up.
Setting CSV File Format	Click to specify the layout of backup data in a CSV file. Refer to the <Logging Common Property> section that follows for detailed information.
Cycle Unit Backup Mode	It is possible to save data in units of a user-specified fixed period (year/month/day/hour/minute). However, the logging area is deleted after backup.
File Type	Select a backup file type (CSV, Encrypted CSV, CSV+PDF). A CSV file can be opened using applications such as Memo Pad and MS Excel. An encrypted CSV file (with the file extension CSVE) can be converted to a CSV file using the CSV Converter ([Tool]-[CSV file converter]). Refer to <4.6 Using the CSV Converter> for more details.
File Name Device	Specify a device to contain the file name of backup data. From the specified device, four consecutive word devices are used as the file name. If the device fails to read the data or the name string does not exist in the data, the backup file is saved as "noname.CSV."
BYTE Swap of File Name	Set to run a byte swap for the string value when using the file name device.
File Name Length	Set the length (in bytes) of the file name.
Append Data to CSV File	Set to add new backup data to the end of the previous CSV file. By default, the logs that are backed up as the appendix to a CSV

Function	Description
	file are stored without creating the date folder. You can select the 'File Generation as Date/Time Folder structure' option to create new folders by dates and store the backup files in the folders. Creating folder structures by dates is explained in <4.7 Managing External Storage Sources for Backup> .
Number of Backup Data in CSV File	Set the number of logs to save in a CSV file (maximum of 65,000).
Create Logging No. Directory	When logging, number directory is created and backed up below. If this feature is disabled (unchecked), backup file is created without creating number directory. However, only one of several loggings can be disabled (unchecked) "Create Logging No. Directory."

• **CSV + PDF File BackUp (Version 3.20 or later applied):**

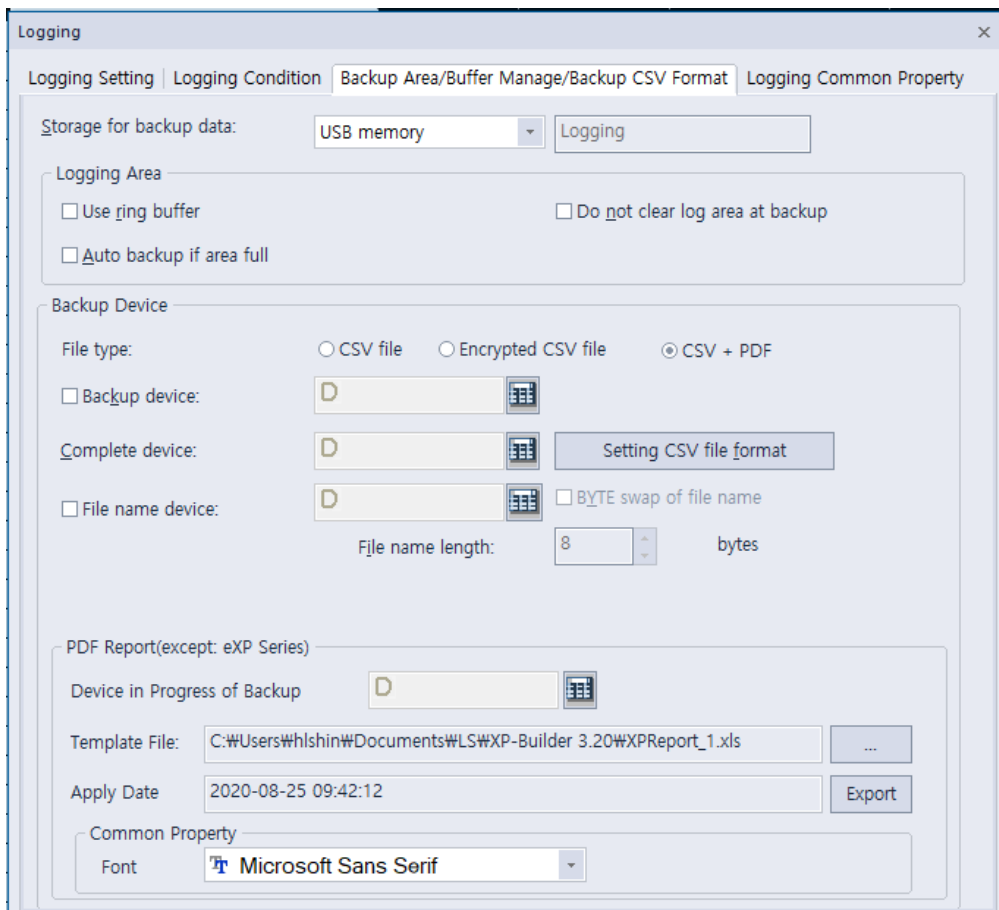

* PDF file backup is only available on the iXP, iXP2, wXP models.

Function	Description
File Type	Select a backup file type (CSV, Encrypted CSV, CSV+PDF). A CSV file can be opened using applications such as

Function	Description
Backup Device	<p>Memo Pad and MS Excel. An encrypted CSV file (with the file extension CSVE) can be converted to a CSV file using the CSV Converter ([Tool]-[CSV file converter]). Refer to <4.6 Using the CSV Converter> for more details.</p> <hr/> <p>If the file type set as “CSV + PDF”,</p> <ul style="list-style-type: none"> • CSV file: The data saved in the logging data storage area (NVRAM) is saved to the designated storage. • PDF file: adds the contents of the CSV file to the template file (.xls format) entered by the user and backs it up as a pdf file. The PDF file name and path are the same as the CSV file and the extension is PDF. <p>If the “Auto Backup if area full” option is set, CSV file backup is performed when the storage space is used up and PDF files are also backed up.</p>
Complete Device	Turns on when both CSV file and PDF backup to the designated storage are successful.
Setting CSV File Format	Click to specify the layout of backup data in a CSV file. Refer to the <Logging Common Property> section that follows for detailed information.
Cycle Unit Backup Mode	It is possible to save data in units of a user-specified fixed period (year/month/day/hour/minute). However, the logging area is deleted after backup.
File Name Device	Specify a device to contain the file name of backup data. From the specified device, four consecutive word devices are used as the file name. If the device fails to read the data or the name string does not exist in the data, the backup file is saved as “noname.CSV.”
File Name Length	Set the length (in bytes) of the file name.
Byte Swap of File Name	Set to run a byte swap for the string value when using the file name device.
PDF Report – Device in Progress of Backup	Displays the backup status of PDF files. If the PDF file is being backed up, the device turns “ON” and when it is completed, it turns “OFF”. Unlike CSV backup, PDF file backup cannot be backed up to multiple files at the same time, and the next PDF backup is performed only when the previous PDF backup is completed. Therefore, when a PDF file backup is requested, if the device is “ON” during backup, the PDF backup function is not performed.
PDF Report – Template File	This is a form file to output the contents backed up in the CSV file. The template file format only supports .xls (97-2003 excel) format. The user can output the data to be printed as a PDF file by entering reserved words in the

Function	Description																		
	template file. - List of available reserved words																		
	<table border="1" style="width: 100%; border-collapse: collapse;"> <thead> <tr> <th style="background-color: #cccccc;">Reserved Word</th> <th style="background-color: #d9e1f2;">Input Value</th> <th style="background-color: #d9e1f2;">Required or Not</th> </tr> </thead> <tbody> <tr> <td>#FILEDATE</td> <td>Date of the PDF file was created</td> <td style="text-align: center;">X</td> </tr> <tr> <td>#NUMBER</td> <td>Total number of times logging has occurred (Num. of log value in CSV file)</td> <td style="text-align: center;">X</td> </tr> <tr> <td>#DATE</td> <td>Time when logging was performed (Value of Data line in CSV file)</td> <td style="text-align: center;">X</td> </tr> <tr> <td>#STATUS</td> <td>Whether logging is successful (Status line value is CSV file)</td> <td style="text-align: center;">X</td> </tr> <tr> <td>#DATA0, DATA1, ...</td> <td>Logging Data (Ex. #DATA0 =< logging value of index 0)</td> <td style="text-align: center;">O</td> </tr> </tbody> </table>	Reserved Word	Input Value	Required or Not	#FILEDATE	Date of the PDF file was created	X	#NUMBER	Total number of times logging has occurred (Num. of log value in CSV file)	X	#DATE	Time when logging was performed (Value of Data line in CSV file)	X	#STATUS	Whether logging is successful (Status line value is CSV file)	X	#DATA0, DATA1, ...	Logging Data (Ex. #DATA0 =< logging value of index 0)	O
	Reserved Word	Input Value	Required or Not																
	#FILEDATE	Date of the PDF file was created	X																
	#NUMBER	Total number of times logging has occurred (Num. of log value in CSV file)	X																
	#DATE	Time when logging was performed (Value of Data line in CSV file)	X																
	#STATUS	Whether logging is successful (Status line value is CSV file)	X																
#DATA0, DATA1, ...	Logging Data (Ex. #DATA0 =< logging value of index 0)	O																	
- Import (...): Import the template file on the project using [Import]. If the set template file is re-edited or changed, it is applied to the project until [Import] is performed again. The last application date and time of the template file are displayed on the screen when [Import] is performed. - Export: User can [Export] the template file set/saved in the project to the path that user wants to save.																			
PDF Report - Font	Set the font used for PDF backup. Only 1 font can be set regardless of the number of CSV + PDF file backups. Depending on the font, Korean, English, or multilingual support is different. If the font you set does not support the language in the template file, the characters may be broken or not visible.																		
Delete old file if disk is full	The oldest CSV and PDF files will be deleted if the option "Delete old file if disk is full" is set in the logging data area.																		
PDF Backup Model	PDF file backup is only available on the iXP, iXP2, wXP models.																		

Note

- Template file
 - Reserved words (#NUMBER, #DATE, #STATUS, #DATA0, #DATA..., etc.) for outputting CSV file data in the template file must all be entered on the same line.
 - Only the first sheet of the template file can be converted to PDF
- PDF size and data output size.
 - The converted PDF size is A4 size, and the orientation is based on the orientation of the template file(.xls) file can be modified in print settings).
 - The maximum number of columns that can be printed is 255. If the line exceeds

the A4 size, it continues the next page.

- The text, image size, etc. in the cells displayed in the PDF are determined in proportion to the fixed size (A4 standard).

- Font

- Some Korean fonts are not compatible with the PDF conversion, so Korean characters may not be output properly. In this case, use a compatible font as shown below.

- Korean compatible fonts: Gulim, Batang, Dodum, Malgun Gothic, Gungseo

- PDF conversion items

- Some character formats (text color, fill color, etc.) are supported, and character styles such as Bold and Italic are not supported.

- Support for merged cells.

- Image files (bmp, png, gif, jpg format) are supported.

- Data such as functions, charts, graphs, etc. other than text and images are not converted to PDF.

- **Logging Common Property:**

The total size of all logging areas cannot exceed the size of each type of logging area.

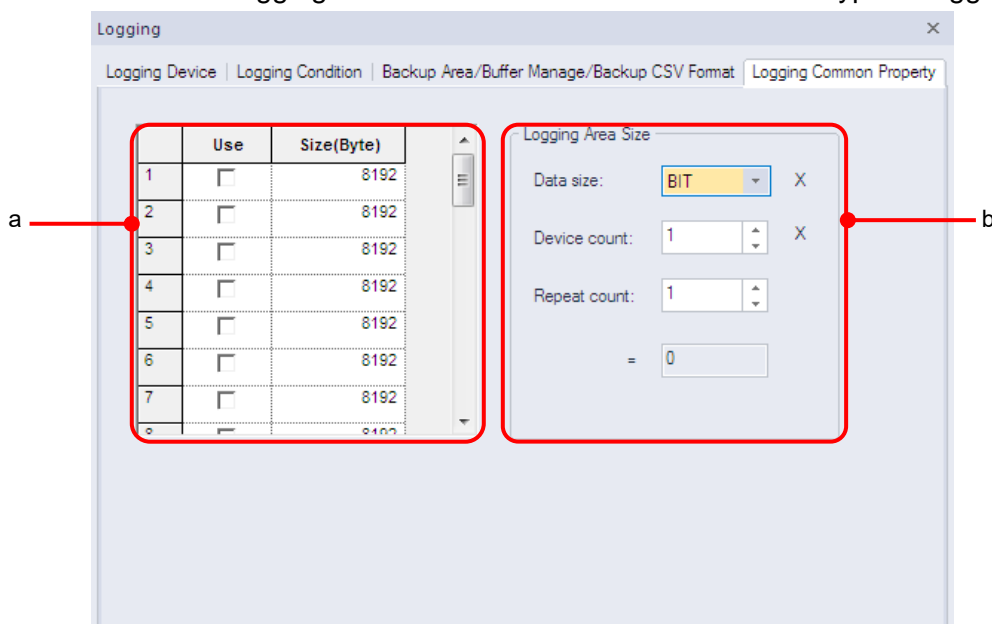

Function	Description
a. Logging Area	Set the size of the data saving area for each log. The logging area can be calculated by the number, size, and frequency of devices.
b. Logging Area Size	Calculate the size of the area required to save logging data: <ul style="list-style-type: none"> • Bit: $[(\text{Repeat count} + 1) * 24]$. The storage size that occurs at one time is fixed to 24bytes. Bit is unconditional(DWORD64), regardless of the device count.

Function	Description
	<ul style="list-style-type: none">• Word: $[(\text{Repeat count} + 1) * (\text{Device count} * 2 + 16)]$. In case of word, one header of 16bytes is recorded before logging.• Double word: $[(\text{Repeat count} + 1) * (\text{Device count} * 4 + 16)]$.

Note

The maximum size of a logging area varies by the panel type:

- iXP/IPC/iXP2 Series: 510 KB
- XP Series TTA model: 256 KB
- XP Series BTE/TTE models and eXP, eXP2 Series: 64 KB

To set an external location for backing up log data:

- 1 Click [Common] ► [Project Property Setting] ► [Storage Settings].

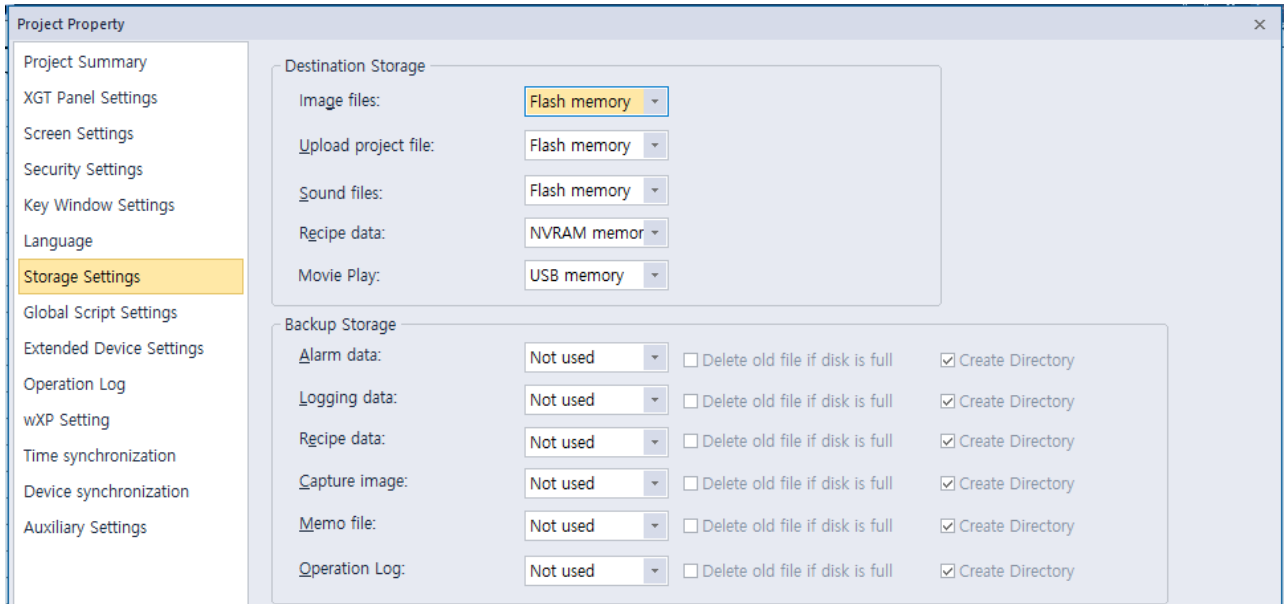

- 2 Set the backup storage location in **Logging data**.

To specify the format for backup data:

- 1 In the Project pane, double-click [Logging].
- 2 Double-click a log entry to open the Logging window.
- 3 Click [Backup Area/Buffer Manage/Backup CSV Format].

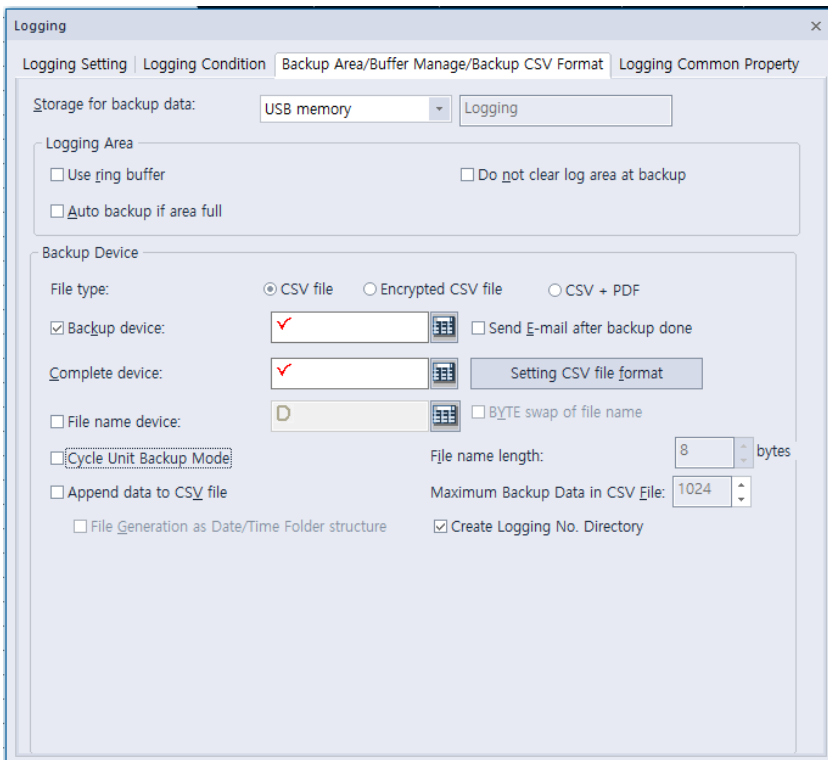

- 4 Set the location for backup data in the **Storage for backup data** field.
- 5 Click [Setting CSV file format].
- 6 Specify the following options:

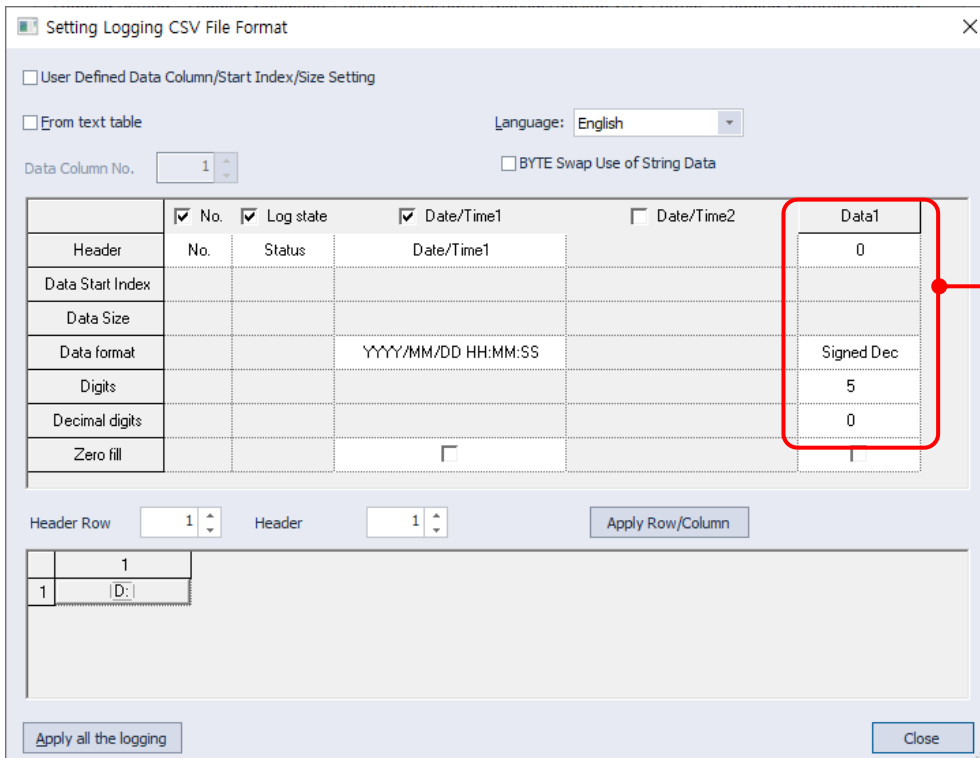

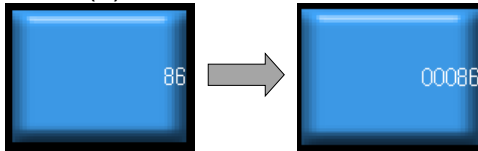
Function	Description
From Text Table	Set to import header information from a text table.
Header	Specify a header for the backup file. If you select the From Text Table option, click [Header] to locate the table.
Data Format	Set the format for displaying the time and date.
Digits	Set how many digits are used for data.
Decimal Digits	Set how many decimal digits are used for data.
Zero Fill	<p>If you have selected right justification, select this option to insert zeros (0) before the number.</p> 
Apply all the Logging	Click to change the backup format for all log data.
Close	Save your changes and close the dialog box
Data Information	The number of data columns shown varies based on the number of logging devices specified.
Store as a Single String	The logged data is not interpreted as numbers but as character strings when they are saved as a file.
Language	<p>Select the language to use for the saved logging data. If the logged data is saved as character strings during a backup of logging data, the data is interpreted as Unicode values and saved as character strings. Character strings are saved on a device in multibyte format and a conversion table (also referred to as a code page) is needed to convert the multibyte format to Unicode format.</p> <p>One language in [Project Property setting]–[Language]–[Multilingual font] can be selected at a time. Therefore, if a Korean font is specified in [Project Property setting]–[Language]–[Multilingual font], Korean must be selected as the language for logging backup before Korean language logging data can be displayed during logging backup.</p> <p>Refer to <2.2.2.6 Changing Languages> for more information.</p>
Header Row	Specifies the number of rows related to string information to be displayed at the front of the page in report format. If you click the 'Apply Row/Column' button on the right, the number of header rows displayed on the grid.
Header	Specifies the number of columns related to string information to be displayed at the front of the page in report format. If you click the 'Apply Row/Column' button on the right, the number of header columns is displayed on the grid.

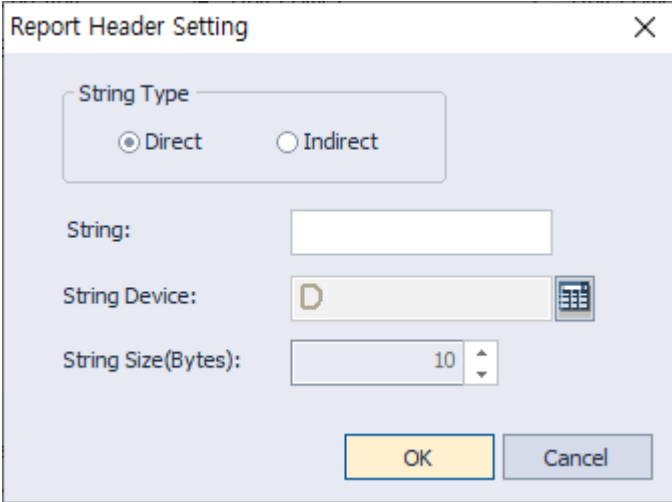
Function	Description
Report Header Setting	<p>Set the string information to be displayed at the front of the page in report format. When you click a cell, the dialog box below where you can set the string appears. Direct or indirect type can be set. In the case of direct, input the string to be displayed. In the case of indirect, specify the string device and string size to read.</p> 

4.1.4 Recipes

You can use recipes to save and reuse process data. You can write or read data to a large number of consecutive devices with recipes. You must set both read and write devices to execute recipes.

Two types of recipes are available: basic and file recipes.

Type	Description																																				
Basic	Export data to non-volatile internal memory in an XGT Panel or to external memory devices. If the power supply to the XGT Panel is interrupted, the most recent data is saved on the NVRAM. The saved data is used for reading or writing operation when monitoring resumes.																																				
File	<p>The data is stored in a CSV file. You can store the file on an external device, such as a USB drive or CF card, to run it on an HMI.</p> <p>The name of the file recipe is written as shown below:</p> <ul style="list-style-type: none"> • /Storage Card_root/XP_Recipe/XPR00000.CSV • /USB Storage_root/XP_Recipe/XPR00000.CSV <p>Refer to <4.7.1.2 Path for Recipe Backup> for detailed information about storing the backup files.</p> <p>When you open the CSV file, you can view the data as shown below:</p> <table border="1"> <thead> <tr> <th></th> <th>A</th> <th>B</th> </tr> </thead> <tbody> <tr> <td>1</td> <td>Date</td> <td>2008-09-19 17:10</td> </tr> <tr> <td>2</td> <td>Title</td> <td>Bread</td> </tr> <tr> <td>3</td> <td>Item Count</td> <td>100</td> </tr> <tr> <td>4</td> <td>3245</td> <td></td> </tr> <tr> <td>5</td> <td>3</td> <td></td> </tr> <tr> <td>6</td> <td>6</td> <td></td> </tr> <tr> <td>7</td> <td>24</td> <td></td> </tr> <tr> <td>8</td> <td>562</td> <td></td> </tr> <tr> <td>9</td> <td>64</td> <td></td> </tr> <tr> <td>10</td> <td>2</td> <td></td> </tr> <tr> <td>11</td> <td>45</td> <td></td> </tr> </tbody> </table>		A	B	1	Date	2008-09-19 17:10	2	Title	Bread	3	Item Count	100	4	3245		5	3		6	6		7	24		8	562		9	64		10	2		11	45	
	A	B																																			
1	Date	2008-09-19 17:10																																			
2	Title	Bread																																			
3	Item Count	100																																			
4	3245																																				
5	3																																				
6	6																																				
7	24																																				
8	562																																				
9	64																																				
10	2																																				
11	45																																				

4.1.4.1 Basic Recipes

The following examples explain the read and write operation using basic recipes.

Read device operation

When the read device is in a rising or falling edge, data is read from the specified starting device address for as many devices as have been specified.

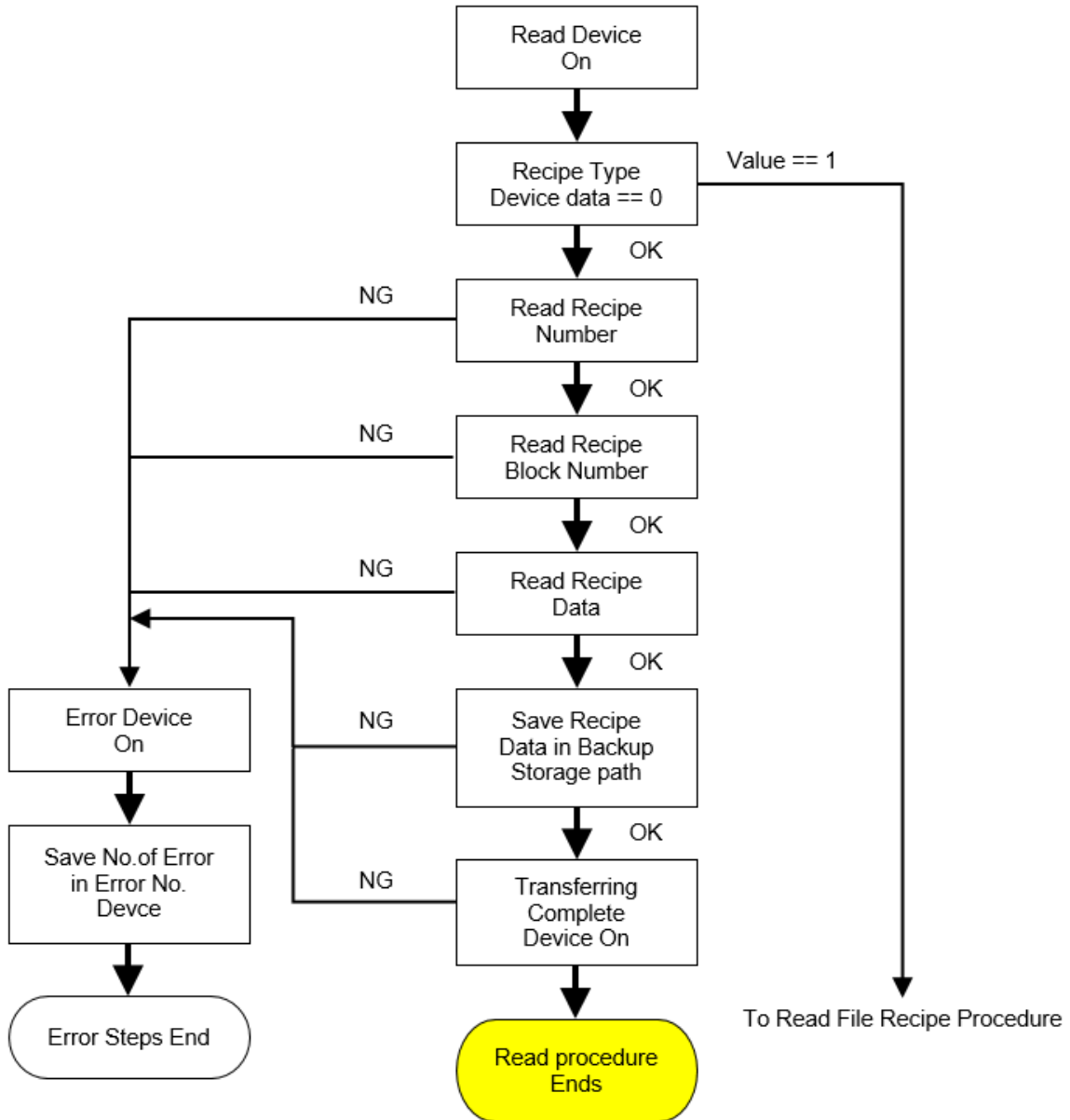
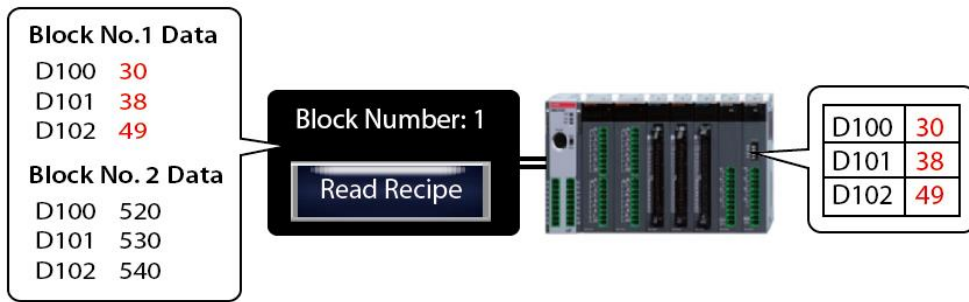

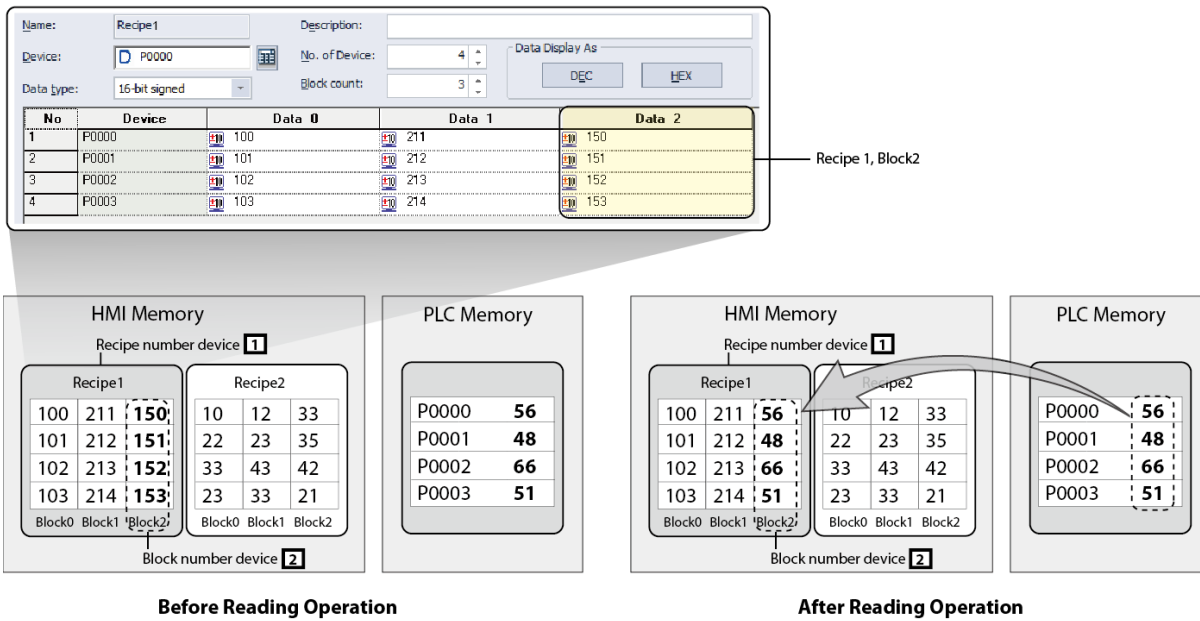

Write device operation

When the write device is in a rising or falling edge, data is written from the specified starting device address to as many devices as have been specified.

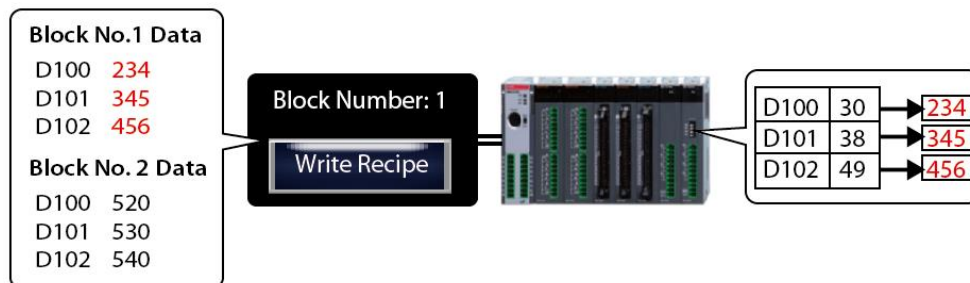

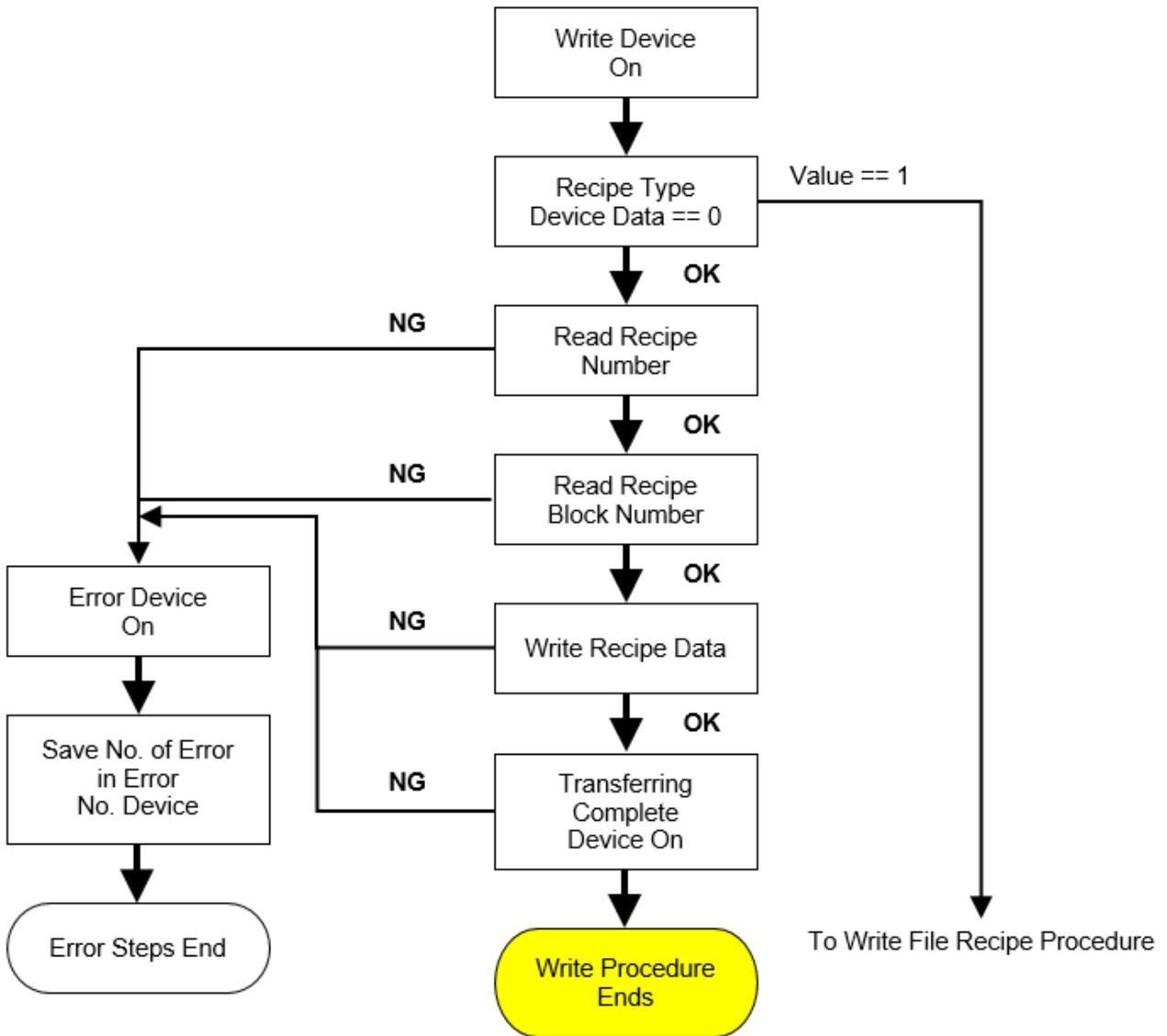

Name: Recipe1 Description:

Device: P0000 No. of Devices: 4 Data Display As: DEC HEX

Data type: 16-bit signed Block count: 3

No	Device	Data 0	Data 1	Data 2
1	F0000	100	211	150
2	F0001	101	212	151
3	F0002	102	213	152
4	F0003	103	214	153

Recipe 1, Block2

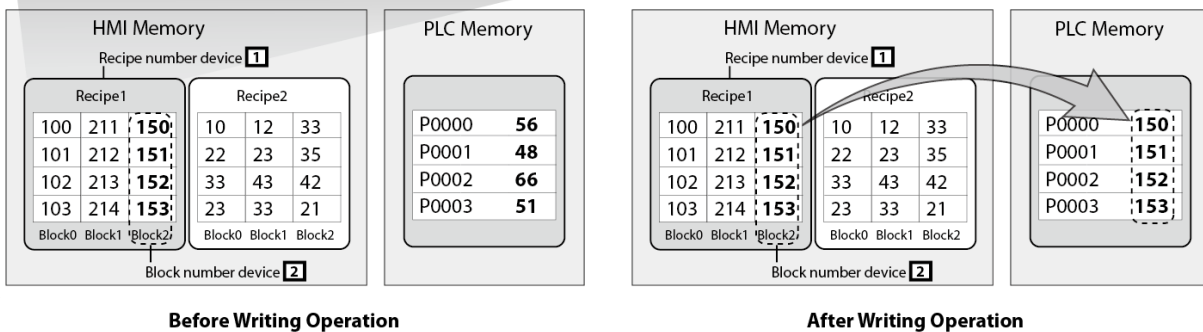

To create a basic recipe:

- 1 In the Project pane, right-click [Basic Recipe].
- 2 Click [Insert].

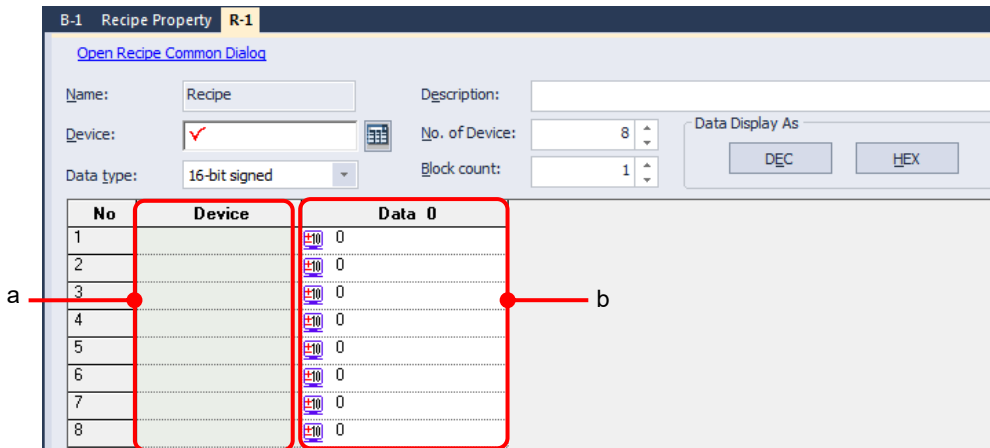

- 3 Set the following properties:

Option	Description
Name	The name of the recipe. You can register up to 255 recipes (1 to 255). If you want to change the name, right-click the recipe name in the Project pane and click [Rename].
Device	Set the device address to transfer the recipe data.
Data type	View the data type of the device. When you enter the value in the data block, the data type is changed according to the data type.
Description	Enter a description for the recipe.
No. of Device	Set the number of devices. Recipe data will be transferred consecutively from as many devices as you specify.
Block count	Set the number of data blocks. The maximum number of available blocks is 255 (0–254).
a. Device	View the device list. Recipes use consecutive data sets, so you cannot set each device address.
b. Data	The block number is assigned starting from 0 and you cannot change it. If you reduce the block number, the data set with biggest block number is deleted first.

Note

The writing and reading functions cannot be executed simultaneously. When two devices meet the same condition simultaneously, writing will be performed first.

Updating and Maintaining Default Recipe Data

Recipe data files are stored in the XGT Panel's non-volatile memory or on an external storage device. The most recently saved data is retained even when the power is turned off. When the power is turned on again and device monitoring begins, the last stored data is used for subsequent read and write operations.

If the recipe data is set to be saved on an external storage device and not in NVRAM, the recipe data is recorded in a file format on the storage device when monitoring begins. The file content is updated when the recipe data read operation is performed. Changes are retained as long as the file remains on the storage device, and the file is generated again when it is deleted or another storage unit is mounted. In this situation, the previously updated data is not retained and is reset to the recipe data that is initially set in XP-Builder.

The recipe data is not deleted when there is a partial download or when the download is only of the changes in the project. However, the stored recipe data is deleted in all downloads if the [Delete all monitoring data] option is selected.

Backup and Restoration of Default Recipe Data

The default recipe data can be backed up in the CSV file format. One backup file is generated for each recipe. To restore default recipe data to a selected file, select a backup file from the File Explorer object and click the [Restoration of Basic Recipe Backup] special switch.

Refer to **<4.7.1.2 Path for Recipe Backup>** for detailed information about storing recipe backup files.

The process of restoring the default recipe data may fail in the following situations. For information about data transmission errors, go to [Error Device].

- The recipe file selected from File Explorer is the backup file generated by another project.
- The recipe setting changed after the selected backup file in File Explorer was created.
- A user modified the recipe backup file or the file is corrupted due to a storage device error.

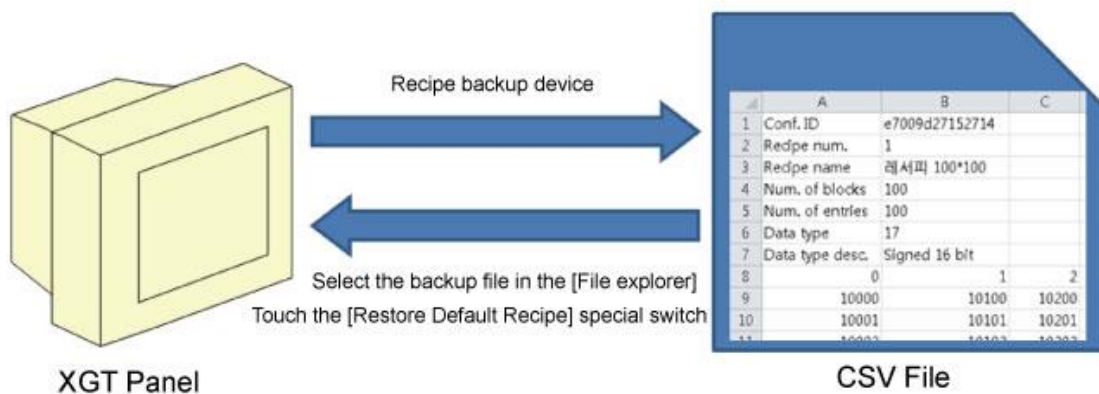

To set Basic recipe properties:

- 1 In the Project pane, double-click [Recipe Property]. This will open a Recipe Property tab in the editing area.

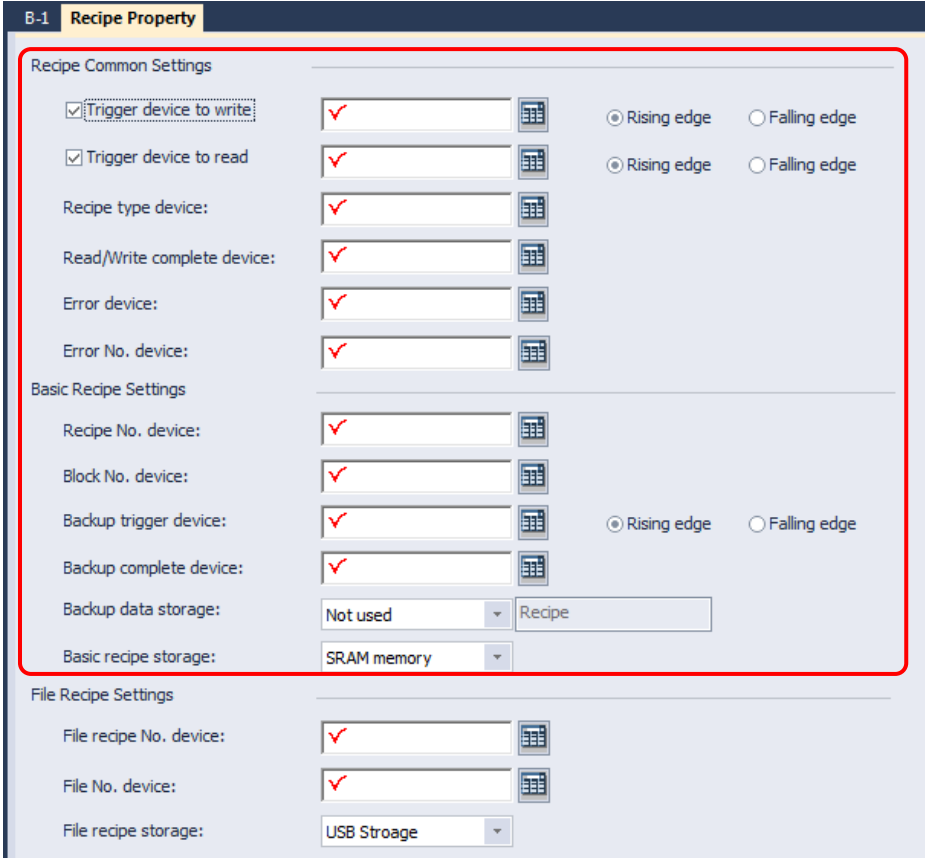

- 2 Set the following properties:

- <Recipe Common Settings>

Option	Description
Trigger Device to Write	Set to specify a device for writing data. Set the condition to trigger the action (rising edge or falling edge). Enter the device address manually or click the keypad to the right of the device field.
Trigger Device to Read	Set to specify a device for reading data. Set the condition to trigger the action (rising edge or falling edge). Enter the device address manually or click the keypad to the right of the device field.
Recipe Type Device	Specify the device that will control the recipe type. If the lowest bit of the device is 0, a basic recipe will be executed. If the lowest bit of the device is 1, a file recipe will be executed. If the lowest bit of the device is 2, an extended file recipe will be executed. Enter the device address manually or click the keypad to the right of the device field.

Option	Description																																		
Read/Write Complete Device	Specify a bit device to turn on when data transfer is completed. Enter the device address manually or click the keypad to the right of the device field.																																		
Basic recipe Storage	Set a storage location for data from a basic recipe (Flash, CF Card, USB, or SD card). You can also configure storage options in Storage Settings in the Project Property window.																																		
Error Device	Specify a bit device to turn on when a problem occurs with the data transfer. Enter the device address manually or click the keypad to the right of the device field.																																		
Error No. Device	<p>Specify a device to return a pre-defined error number if a problem occurs with the data transfer. The error numbers include:</p> <table border="1" data-bbox="560 840 1362 1986"> <thead> <tr> <th data-bbox="560 840 667 875">No.</th> <th data-bbox="671 840 1362 875">Description</th> </tr> </thead> <tbody> <tr> <td data-bbox="560 882 667 913">1</td> <td data-bbox="671 882 1362 913">There is missing data.</td> </tr> <tr> <td data-bbox="560 920 667 952">2</td> <td data-bbox="671 920 1362 952">The data does not match the current transmission condition.</td> </tr> <tr> <td data-bbox="560 958 667 990">3</td> <td data-bbox="671 958 1362 990">The data count exceeds the count specified by the transmission condition.</td> </tr> <tr> <td data-bbox="560 996 667 1028">4</td> <td data-bbox="671 996 1362 1028">The decimal point position used in the data exceeds the decimal point position specified by the transmission condition.</td> </tr> <tr> <td data-bbox="560 1034 667 1066">5</td> <td data-bbox="671 1034 1362 1066">The data value exceeds the maximum value of the format specified by the transmission condition.</td> </tr> <tr> <td data-bbox="560 1072 667 1104">6</td> <td data-bbox="671 1072 1362 1104">The data value is less than the minimum value of the format specified by the transmission condition.</td> </tr> <tr> <td data-bbox="560 1111 667 1142">11</td> <td data-bbox="671 1111 1362 1142">The recipe number of the default recipe was not read.</td> </tr> <tr> <td data-bbox="560 1149 667 1180">12</td> <td data-bbox="671 1149 1362 1180">There is no recipe that corresponds to the currently specified number.</td> </tr> <tr> <td data-bbox="560 1187 667 1218">13</td> <td data-bbox="671 1187 1362 1218">The block number of the default recipe was not read.</td> </tr> <tr> <td data-bbox="560 1225 667 1256">14</td> <td data-bbox="671 1225 1362 1256">There is no recipe block corresponding to the currently specified number.</td> </tr> <tr> <td data-bbox="560 1263 667 1294">15</td> <td data-bbox="671 1263 1362 1294">The transmission condition number of the file recipe was not read.</td> </tr> <tr> <td data-bbox="560 1301 667 1332">16</td> <td data-bbox="671 1301 1362 1332">There is no file recipe transmission condition that corresponds to the currently specified number.</td> </tr> <tr> <td data-bbox="560 1339 667 1370">17</td> <td data-bbox="671 1339 1362 1370">The file number of the file recipe was not read.</td> </tr> <tr> <td data-bbox="560 1377 667 1408">18</td> <td data-bbox="671 1377 1362 1408">There is no recipe file that corresponds to the currently specified number.</td> </tr> <tr> <td data-bbox="560 1415 667 1447">19</td> <td data-bbox="671 1415 1362 1447">The data in the file recipe is not valid.</td> </tr> <tr> <td data-bbox="560 1453 667 1485">20</td> <td data-bbox="671 1453 1362 1485">The total data count in the file recipe is less than the data count specified by the transmission condition.</td> </tr> </tbody> </table>	No.	Description	1	There is missing data.	2	The data does not match the current transmission condition.	3	The data count exceeds the count specified by the transmission condition.	4	The decimal point position used in the data exceeds the decimal point position specified by the transmission condition.	5	The data value exceeds the maximum value of the format specified by the transmission condition.	6	The data value is less than the minimum value of the format specified by the transmission condition.	11	The recipe number of the default recipe was not read.	12	There is no recipe that corresponds to the currently specified number.	13	The block number of the default recipe was not read.	14	There is no recipe block corresponding to the currently specified number.	15	The transmission condition number of the file recipe was not read.	16	There is no file recipe transmission condition that corresponds to the currently specified number.	17	The file number of the file recipe was not read.	18	There is no recipe file that corresponds to the currently specified number.	19	The data in the file recipe is not valid.	20	The total data count in the file recipe is less than the data count specified by the transmission condition.
No.	Description																																		
1	There is missing data.																																		
2	The data does not match the current transmission condition.																																		
3	The data count exceeds the count specified by the transmission condition.																																		
4	The decimal point position used in the data exceeds the decimal point position specified by the transmission condition.																																		
5	The data value exceeds the maximum value of the format specified by the transmission condition.																																		
6	The data value is less than the minimum value of the format specified by the transmission condition.																																		
11	The recipe number of the default recipe was not read.																																		
12	There is no recipe that corresponds to the currently specified number.																																		
13	The block number of the default recipe was not read.																																		
14	There is no recipe block corresponding to the currently specified number.																																		
15	The transmission condition number of the file recipe was not read.																																		
16	There is no file recipe transmission condition that corresponds to the currently specified number.																																		
17	The file number of the file recipe was not read.																																		
18	There is no recipe file that corresponds to the currently specified number.																																		
19	The data in the file recipe is not valid.																																		
20	The total data count in the file recipe is less than the data count specified by the transmission condition.																																		

Option	Description
21	The file recipe data was not recorded.
22	The specified default recipe backup file is the backup file created by another project.
23	The content of the specified default recipe backup file is not valid.
24	The recipe number of the specified default recipe backup file is not valid.
25	The block size of the specified default recipe backup file is not valid.
26	The block status of the specified default recipe backup file is not normal.
27	The content of the specified default recipe backup file in the data area was not written.
28	The memory for the readable content of the specified default recipe was not allocated.

- **<Basic Recipe Settings>**

Option	Description
Recipe No. Device	Specify a device with a block number that will execute the recipe when the condition is met. The recipe is executed by reading the word value (unsigned 16-bit) from the device. Enter the device address manually or click the keypad to the right of the device field.
Block No. Device	Specify a word device that the data will be transferred to when the condition is met. The recipe is executed by reading the word value (unsigned 16-bit) from the device. This option can be used only with basic recipes. Enter the device address manually or click the keypad to the right of the device field.
Backup Trigger Device	Specify a device to back up the recipe data saved in a removable memory device, such as a USB drive or CF card. Set a condition for backing up the data (rising edge or falling edge).
Backup Complete Device	Specify a bit device to turn on when the backup is complete.
Backup Data Storage	The backup location of the default recipe data is specified. The backup files are located in the same place as the recipe data backup files that are in [Storage Settings] in the Project

Option	Description
Basic Recipe Storage	<p>Property window. Refer to <4.7.1.2 Path for Recipe Backup> for detailed information about storing backup files.</p> <hr/> <p>The location to save the default recipe is specified. If NVRAM memory is selected, data is saved in the XGT Panel. If other options are selected, data is saved to a relevant external storage device.</p>

4.1.4.2 File Recipes

File recipe conditions and data is edited separately. A file recipe is operated when the recipe common setting for [Recipe Type Device] is 1.

The following examples explain the read and write operation using file recipes.

Read device operation

The file recipe reading operation begins when the [Read begin] device has a recipe common setting of On. The sequence for reading the file recipe is described as follows: read and write actions cannot be executed at the same time. When recipe read and write operations are performed at the same time, the read operation is executed first.

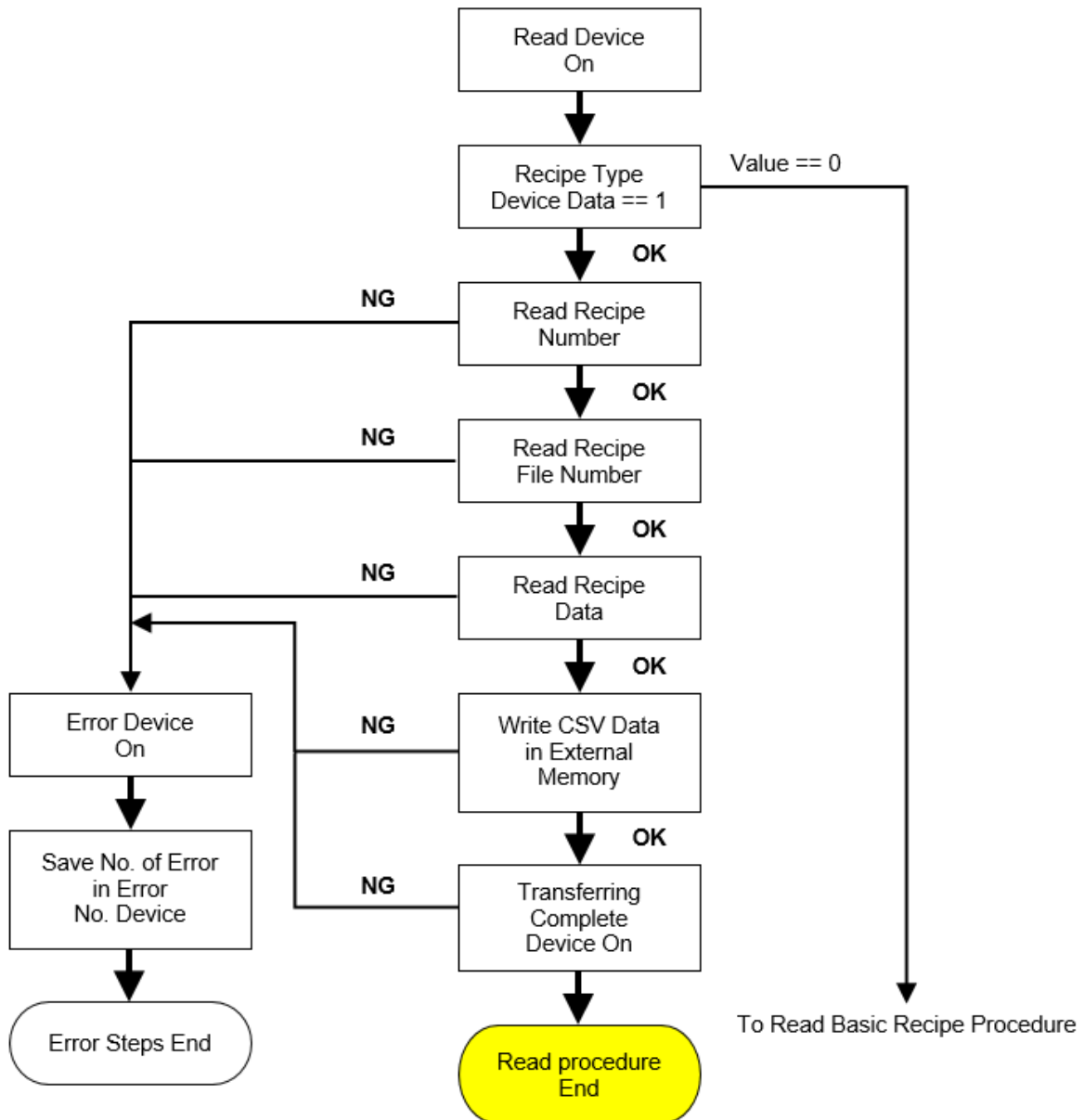

File Recipe Read operation sample:

[Settings]

- (1) [Recipe type device]: 1 (0: Basic Recipe, 1: File Recipe, 2: Extended File Recipe)
- (2) [File Recipe No. device]: 2
- (3) [File No. device]: 3
- (4) File recipe storage: USB Memory

In the case of setting as above, when the device set in [Trigger device to read] in recipe property is On, it is selected as follows.

B-1 File Recipe Data * File Recipe Condition *

[Open Recipe Common Settings Window...](#) [Open File Recipe Data Window...](#)

File Recipe Condition list:

	Recipe No.	Device	Device Count	Device Size	Data Format	Digit Count	Decimal Places	Zero Fill
1	0	Hw00000	8	16 Bit	Unsigned Dec	5	0	<input type="checkbox"/>
2	1	Hw00100	8	16 Bit	Unsigned Dec	5	0	<input type="checkbox"/>
3	2	Hw00200	8	16 Bit	Unsigned Dec	5	0	<input type="checkbox"/>
4	3	Hw00300	8	16 Bit	Unsigned Dec	5	0	<input type="checkbox"/>
5	4	Hw00400	8	16 Bit	Unsigned Dec	5	0	<input type="checkbox"/>

B-1 File Recipe Data * File Recipe Condition *

[Open Recipe Common Settings Window...](#) [Open File Recipe Condition Window...](#) [Export Files...](#)

File list:

	File No.	Data Count	Name	Comment	File Name
1	1	8	Data_1		XPR00001.csv
2	3	8	Data_2		XPR00003.csv
3	5	8	Data_3		XPR00005.csv
4	7	8	Data_4		XPR00007.csv

Reads unsigned decimal data stored in 8 devices starting from HW200 designated in file recipe number 2 and saves it as XPR00003.CSV file in the USB memory designated as the file recipe storage apth. The phrase set in the "Name" column of the file recipe data is included in the file name and displayed.

Refer to **<4.7.1.2 Path for Recipe Backup>** for detailed information about storing the recipe backup files.

Write device operation

Writing data for a file recipe starts when the [Write begin] device in a recipe common setting is set to “On” (rising edge) or “Off” (falling edge). The data writing sequence is shown in the below flow chart.

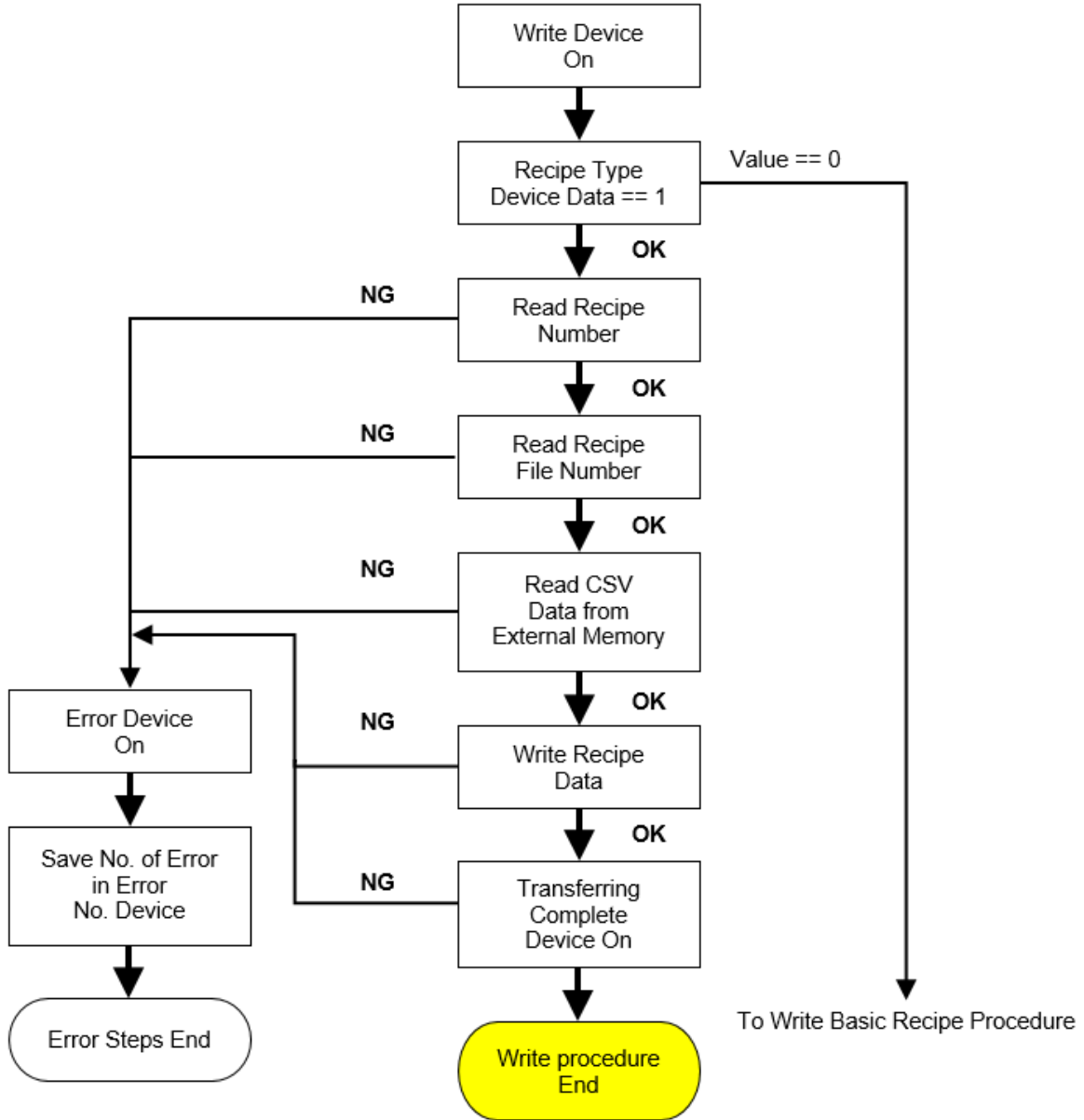

File Recipe Write operation sample:

[Settings]

- (1) [Recipe type device]: 1 (0: Basic Recipe, 1: File Recipe, 2: Extended File Recipe)
- (2) [File Recipe No. device]: 2
- (3) [File No. device]: 3
- (4) File recipe storage: USB Memory

In the case of setting as above, when the device set in [Trigger device to write] in recipe property is On, it is selected as follows.

B-1 File Recipe Data * File Recipe Condition *

[Open Recipe Common Settings Window...](#) [Open File Recipe Data Window...](#)

File Recipe Condition list:

	Recipe No.	Device	Device Count	Device Size	Data Format	Digit Count	Decimal Places	Zero Fill
1	0	HW00000	8	16 Bit	Unsigned Dec	5	0	<input type="checkbox"/>
2	1	HW00100	8	16 Bit	Unsigned Dec	5	0	<input type="checkbox"/>
3	2	HW00200	8	16 Bit	Unsigned Dec	5	0	<input type="checkbox"/>
4	3	HW00300	8	16 Bit	Unsigned Dec	5	0	<input type="checkbox"/>
5	4	HW00400	8	16 Bit	Unsigned Dec	5	0	<input type="checkbox"/>

B-1 File Recipe Data * File Recipe Condition *

[Open Recipe Common Settings Window...](#) [Open File Recipe Condition Window...](#) [Export Files...](#)

File list:

	File No.	Data Count	Name	Comment	File Name
1	1	8	Data_1		XPR00001.csv
2	3	8	Data_2		XPR00003.csv
3	5	8	Data_3		XPR00005.csv
4	7	8	Data_4		XPR00007.csv

The data saved in the XPR00003.CSV file of the USB memory set as the file recipe saving path is read and saved in 8 devices starting from HW200.

To set file recipe properties:

- 1 In the Project pane, double-click [Recipe Property]. This will open a Recipe Property tab in the editing area.

The image shows a 'Recipe Property' dialog box with three main sections: 'Recipe Common Settings', 'Basic Recipe Settings', and 'File Recipe Settings'. The 'Recipe Common Settings' section includes checkboxes for 'Trigger device to write' and 'Trigger device to read', both checked, and input fields for 'Recipe type device', 'Read/Write complete device', 'Error device', and 'Error No. device', all containing a red checkmark. It also has radio buttons for 'Rising edge' and 'Falling edge' for each trigger, with 'Rising edge' selected. The 'Basic Recipe Settings' section includes input fields for 'Recipe No. device', 'Block No. device', 'Backup trigger device', and 'Backup complete device', all with red checkmarks. It also has radio buttons for 'Rising edge' and 'Falling edge' for the backup trigger, with 'Rising edge' selected. A 'Backup storage path' dropdown is set to 'Not used' and a text field contains 'Recipe'. The 'Basic recipe storage' dropdown is set to 'NVRAM memory'. The 'File Recipe Settings' section includes input fields for 'File recipe No. device' and 'File No. device', both with red checkmarks, and a 'File recipe storage' dropdown set to 'USB memory'. A red box highlights the 'Recipe Common Settings' and 'File Recipe Settings' sections.

- 2 Set the following properties:

- <Recipe Common Settings>

Option	Description																
Trigger Device to Write	Set to specify a device for writing data. Set the condition to trigger the action (rising edge or falling edge). Enter the device address manually or click the keypad to the right of the device field.																
Trigger Device to Read	Set to specify a device for reading data. Set the condition to trigger the action (rising edge or falling edge). Enter the device address manually or click the keypad to the right of the device field.																
Recipe Type Device	Specify the device that will control the recipe type. If the lowest bit of the device is 0, a basic recipe will be executed. If the lowest bit of the device is 1, a file recipe will be executed. The lowest bit of device is 2, an extended file recipe will be executed. Enter the device address manually or click the keypad to the right of the device field.																
Read/Write Complete Device	Specify a bit device to turn on when data transfer is completed. Enter the device address manually or click the keypad to the right of the device field.																
Basic recipe Storage	Set a storage location for data from a basic recipe (Flash, CF Card, USB, or SD card). You can also set storage options in Storage Settings in the Project Property window.																
Error Device	Specify a bit device to turn on when a problem occurs with the data transfer. Enter the device address manually or click the keypad to the right of the device field.																
Error No. Device	Specify a device to return a pre-defined error number if a problem occurs with the data transfer. The error numbers are listed below. <table border="1" data-bbox="571 1413 1347 2018"> <thead> <tr> <th>No.</th> <th>Description</th> </tr> </thead> <tbody> <tr> <td>1</td> <td>There is missing data.</td> </tr> <tr> <td>2</td> <td>The data does not match the current transmission condition.</td> </tr> <tr> <td>3</td> <td>The data count exceeds the count specified by the transmission condition.</td> </tr> <tr> <td>4</td> <td>The decimal point position used in the data exceeds the decimal point position specified by the transmission condition.</td> </tr> <tr> <td>5</td> <td>The data value exceeds the maximum value of the format specified by the transmission condition.</td> </tr> <tr> <td>6</td> <td>The data value is less than the minimum value of the format specified by the transmission condition.</td> </tr> <tr> <td>11</td> <td>The recipe number of the default recipe was not read.</td> </tr> </tbody> </table>	No.	Description	1	There is missing data.	2	The data does not match the current transmission condition.	3	The data count exceeds the count specified by the transmission condition.	4	The decimal point position used in the data exceeds the decimal point position specified by the transmission condition.	5	The data value exceeds the maximum value of the format specified by the transmission condition.	6	The data value is less than the minimum value of the format specified by the transmission condition.	11	The recipe number of the default recipe was not read.
No.	Description																
1	There is missing data.																
2	The data does not match the current transmission condition.																
3	The data count exceeds the count specified by the transmission condition.																
4	The decimal point position used in the data exceeds the decimal point position specified by the transmission condition.																
5	The data value exceeds the maximum value of the format specified by the transmission condition.																
6	The data value is less than the minimum value of the format specified by the transmission condition.																
11	The recipe number of the default recipe was not read.																

Option	Description
12	There is no recipe that corresponds to the currently specified number.
13	The block number of the default recipe was not read.
14	There is no recipe block that corresponds to the currently specified number.
15	The transmission condition number of the file recipe was not read.
16	There is no file recipe transmission condition that corresponds to the currently specified number.
17	The file number of the file recipe was not read.
18	There is no file recipe file that corresponds to the currently specified number.
19	The data in the file recipe is not valid.
20	The total data count in the file recipe is less than the data count specified by the transmission condition.
21	The file recipe data was not recorded.
22	The specified default recipe backup file is the backup file created by another project.
23	The content of the specified default recipe backup file is not valid.
24	The recipe number of the specified default recipe backup file is not valid.
25	The block size of the specified default recipe backup file is not valid.
26	The block status of the specified default recipe backup file is not normal.
27	The content of the specified default recipe backup file in the data area was not written.
28	The memory for the readable content of the specified default recipe was not allocated.

- <File Recipe Settings>

Option	Description
File Recipe NO. Device	Set a word device for the file recipe number.
File NO. Device	Set a word device for the data file number.
File recipe Storage	Set a storage location for data from a file recipe (CF card, USB device, or SD card).

To view the File Recipe Condition screen:

In the Project pane, double-click [Recipe] ► [File recipe] ► [File Recipe Condition].

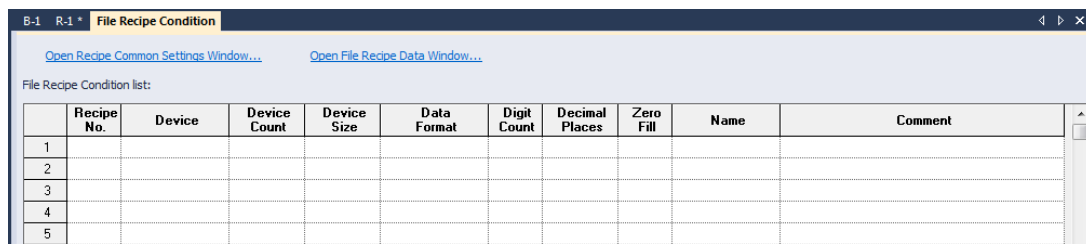

Option	Description
Recipe No.	Enter the file recipe number. The number cannot be duplicated.
Device	Enter the device that will receive the recipe data. Read and write actions are performed by reading the data received in this device and writing it to a file. Enter a word device.
Device Count	Set the number of contiguous devices from the corresponding device that will be read or written.
Device Size	Select 16 bits or 32 bits.
Data Format	Specify a format for device value-character sting conversion. During a read operation using a file recipe, the device value in the controller is converted to a character string for reading, and the character string is reverted to the device value when it is written.
Digit Count	Specify the number of places for a value. The device value in the file recipe data is converted to a character string for reading, and the character string is reverted to a writing value. The part of a number exceeding the specified places will be displayed as asterisks (*).
Decimal Place	Enter the decimal place for the data to be displayed at.
Zero Fill	Blank digits are filled with a 0 based on the data type.
Name	Enter the name.
Comment	Enter the description

Note

- The valid file recipe number range is 0 – 5,000.
- The valid device count range is 1 – 10,000.
- The valid number count range is 1 - 64.
- The valid decimal place range is 0 - 63.
- The decimal place setting cannot be larger than the number count.

To view the File Recipe Data screen:

In the Project pane, double-click [Recipe] ► [File Recipe] ► [File Recipe Condition].

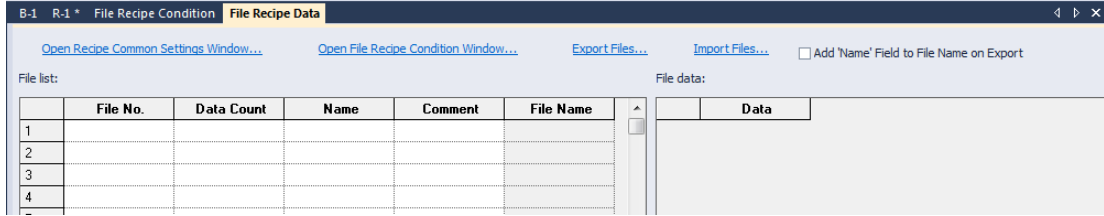

Option	Description
File No.	Enter the file data number.
Data Count	Enter the number of data to be stored in the file.
Name	Enter the name of the recipe file. The file name is displayed in versions prior to 1.30.
Add "Name" Field to File Name on Export	Select this option to include the Name field when exporting the recipe.
Comment	Enter the description.
File Name	File searches automatically use the default file name format: "XPR + file number.csv". This file name is used when exporting the file.
Data	The data in the file selected from [File list] is displayed. Data in this file can be edited. However, ensure that the data meets the conditions (such as data type) that are set for the read/write operation of the recipe when you edit the data. A recipe error will occur if the condition is not met.
Export Files	All file recipe data is saved using CSV file format. Select an external storage drive, such as a USB drive. If an "XP_Recipe" folder does not exist on the storage drive, it is automatically created on the selected device and the CSV file is saved in the folder.
Import Files	This function retrieves a selected CSV file and loads the values in the file data. Duplicated items are overwritten.

Note

- The valid file number range is 1–65,535.
- The valid data count range is 1–10,000.
- A CSV file can be imported only if its name format is the same as the file name format.

4.1.4.3 Extended File Recipe

Extended File Recipe conditions and data are edited separately. XP-Builder does not support the edit data function and should be stored in the CSV format. Refer to [\[Extended File Recipe Data File Edit\]](#) for detailed information. A file recipe is operated when the recipe common setting for [Recipe type device] is 2. The following examples explain the read and write operation using Extended File Recipes.

Read Device Operation

When [Trigger device to read] device is On, Extended File Recipes will be activated. The sequence for reading the file recipe is described as follows: Read and Write actions cannot be executed at the same time. The read action is executed first when two devices satisfy the same time conditions.

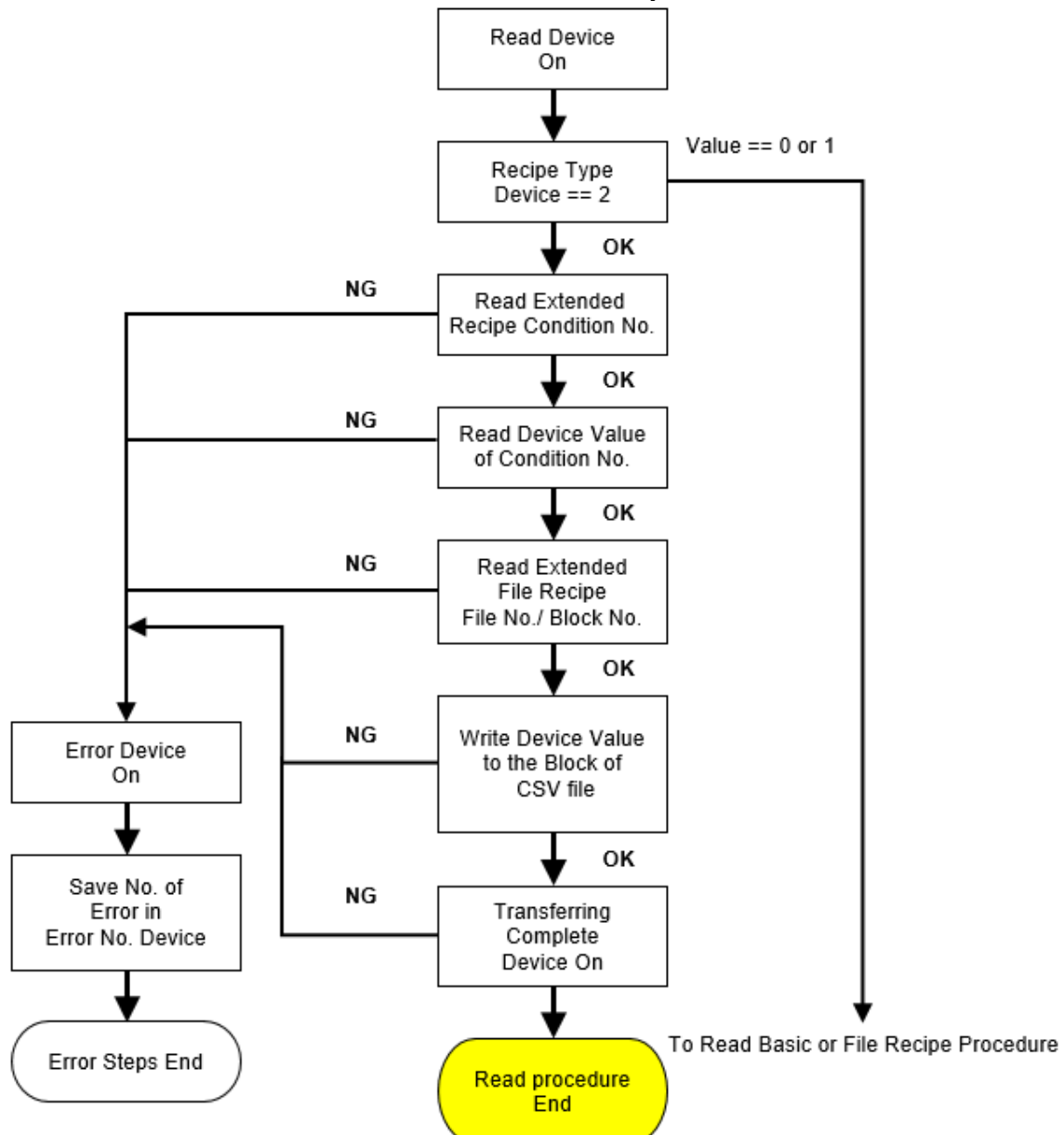

Extended File Recipe Read operation sample:

[Settings]

- (1) [Recipe type device]: 2 (0: Basic Recipe, 1: File Recipe, 2: Extended File Recipe)
- (2) Extended File Recipe [Condition No. device]: 2
- (3) Extended File Recipe [File No./Name device]: 3
- (4) Extended File Recipe [Block No. device]: 4
- (5) Extended File Recipe [Block count device] 3
- (6) Extended File Recipe storage: USB memory

In the case of setting as above, when the device set in [Trigger device to read] in the recipe property is On, 3 data from HW100 set in condition number 2 are read and updated in the 4th block of the XPREX003.CSV file of USB memory as follows.

	Condition No.	Device	Data Format Setting	Name	Comment
1	1	HW00000	Data 3 is(are) set	EF1	Extended File Recipe1
2	2	HW00100	Data 3 is(are) set	EF2	Extended File Recipe2
3	3	HW00200	Data 3 is(are) set	EF3	Extended File Recipe3
4	4	HW00300	Data 3 is(are) set	EF4	Extended File Recipe4

[Data Format Setting]

Set the data format setting for condition number 2 as follows. For a total of 14 bytes data, set unsigned decimal/real/string as the display format and other formats as follows.

No.	Data size	Display format	Digits	Decimal digits	Zero fill	String length(Bytes)
1	16Bit	Unsigned Dec	5	0	<input type="checkbox"/>	
2	32Bit	Float	10	0	<input type="checkbox"/>	
3		ASCII				8

[CSV Data File Setting]

Set CSV data file as the following: Refer to [\[Extended File Recipe Data File Edit\]](#) for detailed information. Extended File Recipes will be saved on <Storage Device Root Path >\XP_RecipeExt\, files will be named XPREX001.csv, XPREX002.csv ~ XPREX999.csv. In this example, the XPREX003.csv file value

is updated as the File number device value is 3.

The title line should always be a header. Data will start from the second column, meaning the first column will be block number 0, the second column will be block number 1, and the third column will be block number 2. Thus, in the following picture, column 6 will be counted as block 4 and updated.

	A	B	C	
Header	1	data-1	data-2	data-3
Block 0	2	25	3.14	32TA-56TB
Block 1	3	58	2.45	32GA-56RF
Block 2	4	91	1.76	32TA-57TB
Block 3	5	124	1.07	32GA-57RF
Block 4	6	157	0.38	32TA-58TB
Block 5	7	190	-0.31	32GA-58RF

If the XPRES003.csv file does not exist, an empty column will fill blocks 0 to 3 and data will show on block 4.

Refer to [<4.7.1.2 Path for Recipe Backup>](#) for detailed information about storing the recipe backup files.

Write device operation

Writing data for an Extended File Recipe starts when the [Trigger device to write] device in a recipe common setting is set to "On" (rising edge) or "Off" (falling edge). The data writing sequence is shown in the flow chart below.

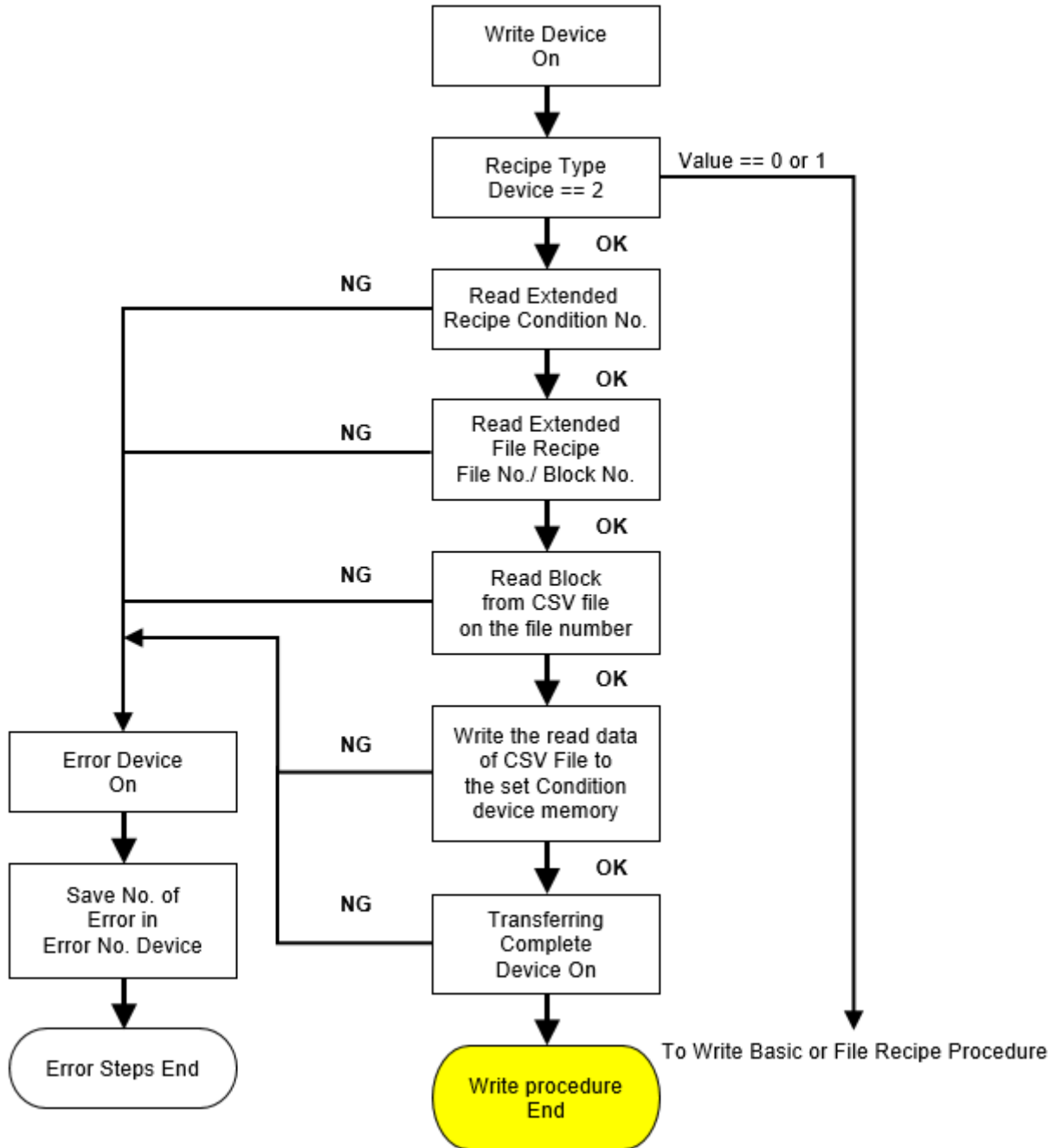

Extended File Recipe Write operation sample:

[Settings]

- (1) [Recipe type device]: 2 (0: Basic Recipe, 1: File Recipe, 2: Extended File Recipe)
- (2) Extended File Recipe [Condition No. device]: 2
- (3) Extended File Recipe [File No./Name device]: 3
- (4) Extended File Recipe [Block No. device]: 4
- (5) Extended File Recipe [Block count device] 3
- (6) Extended File Recipe storage: USB memory

In the case of setting as above, when the device set in [Use write start device] in the recipe property is On, 3 data of block 4 in line 6 of the USB memory XPREX003.csv file are designated as the device of the extended file recipe condition number 2. It will be updated on HW100.

	Condition No.	Device	Data Format Setting	Name	Comment
1	1	HW00000	Data 3 is(are) set	EF1	Extended File Recipe1
2	2	HW00100	Data 3 is(are) set	EF2	Extended File Recipe2
3	3	HW00200	Data 3 is(are) set	EF3	Extended File Recipe3
4	4	HW00300	Data 3 is(are) set	EF4	Extended File Recipe4

[Data Format Setting]

Set the data format setting for condition number 2 as follows. For a total of 14 bytes data, set unsigned decimal/real/string as the display format and other formats as follows.

Language: English

BYTE Swap Use of String Data

No.	Data size	Display format	Digits	Decimal digits	Zero fill	String length(Bytes)
1	16Bit	Unsigned Dec	5	0	<input type="checkbox"/>	
2	32Bit	Float	10	0	<input type="checkbox"/>	
3		ASCII				8

OK Cancel

[CSV Data File Setting]

Set CSV data file as the following: Refer to [\[Extended File Recipe Data File Edit\]](#) for detailed information. Extended File Recipes will be saved on <Storage Device Root Path >\XP_RecipeExt\, files will be

named XPREX001.csv, XPREX002.csv ~ XPREX999.csv. In this example, the XPREX003.csv file value is updated as the File number device value is 3.

Title line should always be a header. Data will start from the second column, meaning the first column will be block number 0, the second column will be block number 1, and the third column will be block number 2. Column 6 will be counted as Block 4, and rewritten as binary data to the PLC device.

	A	B	C
Header	1 data-1	data-2	data-3
Block 0	2 25	3.14	32TA-56TB
Block 1	3 58	2.45	32GA-56RF
Block 2	4 91	1.76	32TA-57TB
Block 3	5 124	1.07	32GA-57RF
Block 4	6 157	0.38	32TA-58TB
Block 5	7 190	-0.31	32GA-58RF

If the XPREX003.csv file does not exist, the Write action will fail.

Refer to **<4.7.1.2 Path for Recipe Backup>** for detailed information about storing the recipe backup files.

To set Extended File Recipe properties:

- 1 In the Project pane, double-click [Recipe Property]. This will open a [Recipe Property] tab in the editing area.

The screenshot shows the 'Recipe Property' dialog box with the following sections and settings:

- Recipe Common Settings:**
 - Trigger device to write: [Device]
 - Trigger device to read: [Device]
 - Recipe type device: [Device] (0: Basic recipe, 1: File recipe, 2: Extended File recipe)
 - Read/Write complete device: [Device]
 - Error device: [Device]
 - Error No. device: [Device]
 - Edge selection: Rising edge, Falling edge
- Basic Recipe Settings:**
 - Recipe No. device: [Device]
 - Block No. device: [Device]
 - Backup trigger device: [Device]
 - Backup complete device: [Device]
 - Backup storage path: Not used (Recipe)
 - Basic recipe storage: NVRAM memory
- File Recipe Settings:**
 - File recipe No. device: [Device]
 - File No. device: [Device]
 - File recipe storage: USB memory
- Extended File Recipe Setting:**
 - Condition No. device: [Device]
 - File No./Name device: [Device] Use as file name device (64 Bytes)
 - Block No. device: [Device]
 - Block count device: [Device]
 - Extended File Recipe storage: USB memory

- 2 Set the following properties: Refer to File Recipes for more information on <Recipe Property>. The following refers to Extended File Recipes.

Option	Description
Condition No. device	Set a word device for the Extended File Recipe condition number.
File No./name device	Set a word device to save the extended file recipe number. By default, it is used as a file number device, but if you check "Use as a file name device," it is recognized as a name device and you can specify a recipe file by saving the file name according to the specified byte.

Block No. device	Set a word device for the extended file recipe block number. When the block number device is used, the recipe can be read or written by the number of blocks stored in the block number device from the block number stored in the device. By default, the block number device is not used much. This means that a single block designated by the block number device is read or written.
Extended File Recipe Storage	Set a storage location for data from an Extended File Recipe. (CF card, USB memory, SD card)

To view the Extended File Recipe condition screen:

In the Project pane, double-click [Recipe] ► [Extended File Recipe] ► [Condition No. Device].

The screenshot shows a software window titled "B-1 * Recipe Property" with a sub-tab "Extended File Recipe Condition *". Below the title bar, there is a link "Open Recipe Common Settings Window...". The main content area is titled "File Recipe Condition list:" and contains a table with the following data:

	Condition No.	Device	Data Format Setting	Name	Comment
1	1	Hw00000	Data 3 is(are) set	EXDR_COND1	EXPR0001.csv
2	2	Hw00100	Data 3 is(are) set	EXDR_COND2	EXPR0002.csv
3	3	Hw00200	Data 2 is(are) set	EXDR_COND3	EXPR0003.csv
4	4	Hw00400	Data 4 is(are) set	EXDR_COND4	EXPR0004.csv

Option	Description
Condition No.	Enter Extended File Recipe number. The valid range is 1 - 100.
Device	Select the file recipe condition device. The Read/Write Device writes data into a file or a condition device. Enter Word Device.
Data Format Setting	Select the device data format manually.
Name	Enter file name.
Comment	Enter a description for the device.

The following refers to Setup box after clicking the [Data Format Setting] button.

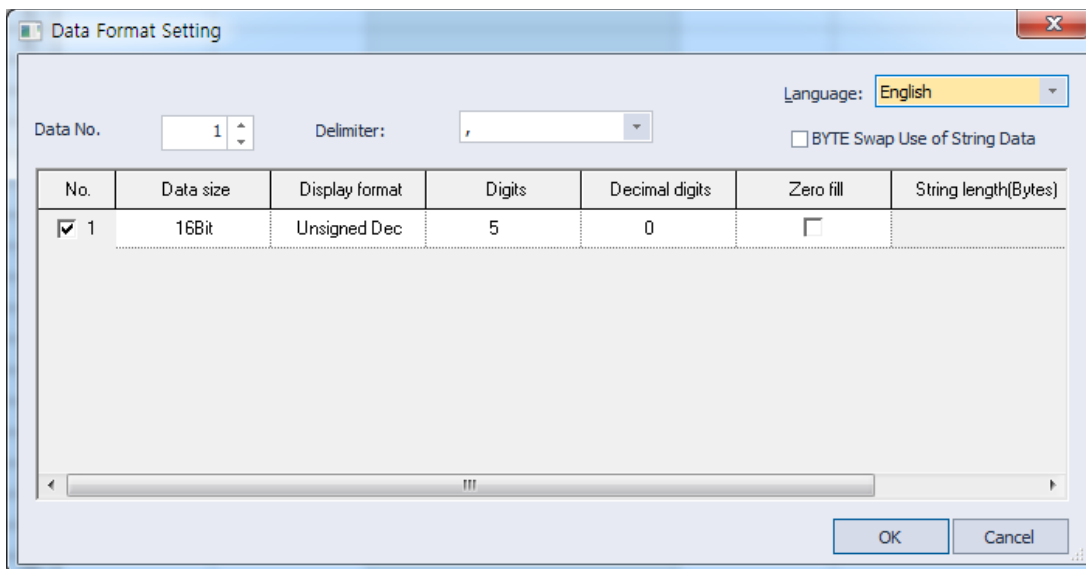

Option	Description
NO.	The checkbox in the number indicates the skip column. This means that if you do not check the box, the data in that column is skipped and read or written. By default, the data in all columns is read or written.
Data size	Choose from 16-bit or 32-bit.
Display format	Specify a format for device value-character string conversion. Set the data type and choose between Unsigned Decimals/Signed Decimals/Octal/Hexadecimal/Binary/Float/Text.
Digits	Set how many digits to display. If the number of digits is less than the capacity of the device, empty spaces are filled with placeholders ("*").
Decimal digits	Set how many places to put it to the right of the decimal point.
Zero fill	If you have selected right justification, select this option to insert zeros (0) before the number.
String length(Bytes)	Can only be written in bytes in text format. Can enter from 1-255.
Delimiter	Can specify the character that separates the data. Can choose from , ; :.

Note

- The valid Extended File Recipe number range is 1-100.
- Maximum device data cannot exceed 2048 bytes when setting data format.
- The valid number count range is 1 - 64.
- The valid decimal place range is 0 - 63.
- The decimal place setting cannot be larger than the number count.

Extended File Recipe data file Edit:

CSV files are normal text files with texts divided with commas. So it can be written with text input such as Notepad or Notepad++, and also on Microsoft Excel. When saving content be sure to select [Save As Project...].

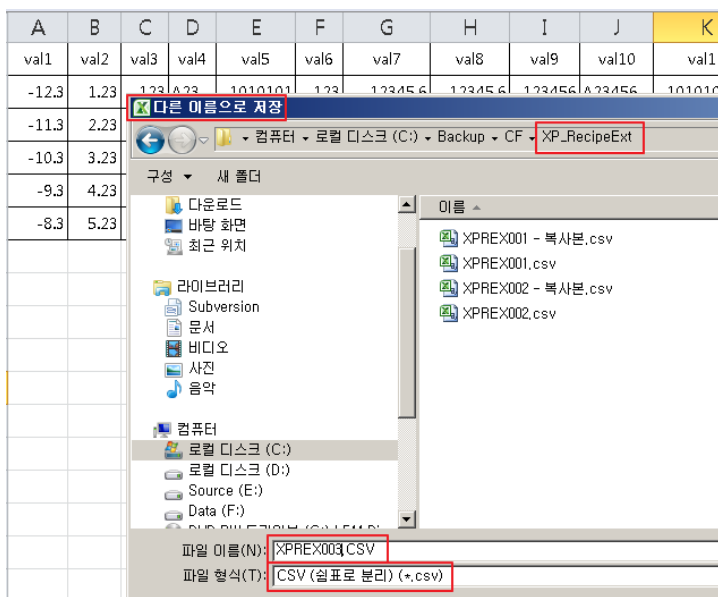

The rules for naming extended file recipes are as follows, and a total of 999 extended file recipe files from 001 to 999 can be used. The file location path is <storage device root path>\XP_RecipeExt\.

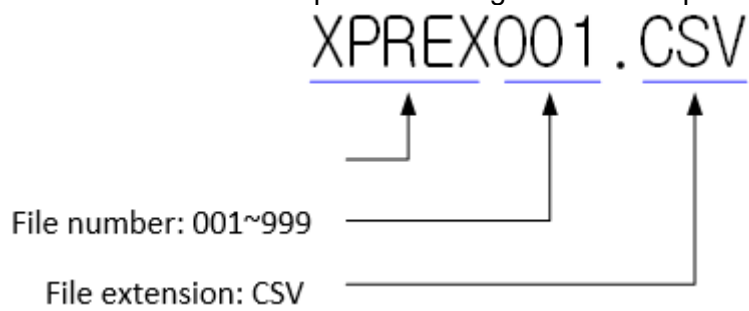

The following is an example for Extended File Recipe setup.

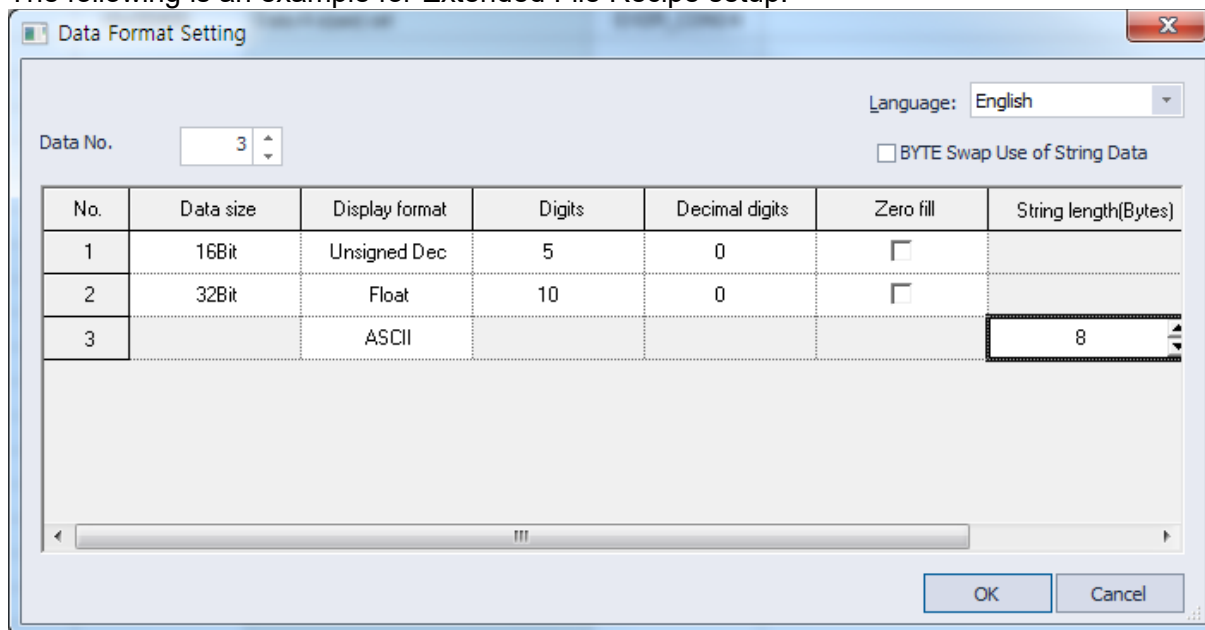

If the Extended File Recipe is setup, the Extended File Recipe data file (CSV file) can be input as such. If column spaces are left empty errors may occur.

	A	B	C
1	data-1	data-2	data-3
2	25	3.14	32TA-56TB
3	58	2.45	32GA-56RF
4	91	1.76	○
5	124	✗	32GA-57RF
6	157	0.38	○
7	190	-0.31	32GA-58RF

If the display format is specified as a string, it can be left black, in which case it is treated as NULL-string. However, if the display format is specified as a number such as decimal/hexadecimal/float it is treated as an error because the value cannot be determined if it is left black.

When you edit Extended File Recipe data, please follow instructions.

Note

- A maximum of 255 data can be setup and input.
- A maximum of 999 data can be input into a single file.
- The maximum file size is 1MB.
- The maximum number of characters is 100.
- Block data cannot exceed 10240 characters.
- When editing with Microsoft Excel, if there are too many digits they will automatically convert to a floating point format, into a significand, and a base. In this case, set to change output data to word form.

An error may occur if CSV file data does not match XP-Builder setup, does not fit aforementioned [Note] format, or other device setup formats. In this case, error code [Error Device] will appear.

Error Number	Summary	Remarks
1	NULL Data	If the output data is a number and data file column is empty.
2	Inappropriate Data	The data cannot be switched to a chosen output data format. For example, 12F is converted into Unsigned decimals.
3	Digit exceeded.	When there is 6 digits while maximum digits are set to 5.
4	The maximum number of decimals is exceeded.	The figure below the decimal point should be 3, but is not.
5	Exceeded The Maximum Value.	When you input a value that exceeds the output data format.
6	Under The Minimum Value.	When you input a value that is smaller than the minimum output data format.
29	The Extended File Recipe block number exceeded the limit.	The number of block data set exceeds the horizontal dimensions and cannot exceed 1000.
30	The maximum number of Extended File Recipe data is exceeded.	If block data is set to horizontal, the maximum number is 255.
31	The maximum number of Extended File Recipe Block Character Strings exceeded.	The maximum number of block data character is 10*1024 characters.
32	The maximum number of Extended File Recipe Value Character String	The value character cannot exceed 100 characters.
33	The maximum number of Extended File Recipe file limit Exceeded.	The maximum recipe data file size is 1MB.
34	Extended File Recipe not found.	When the input recipe, the recipe data file, the directory, or the storage device is not found.
35	Extended File Recipe File access denied.	If the Recipe Data file exists but is inaccessible due to the system.
36	The Extended File Recipe cannot be formed.	When View or Input Recipe failed to make a Recipe Data file.

Error Number	Summary	Remarks
37	The Extended File Recipe cannot be saved to the storage device.	If Extended File Recipe starts and takes over recipe files, it is occupied until monitoring is finished. Click Remove Safety Switch to release the held storage device. If the Recipe Data file fails to occupy the storage device, it will fail to load.
38	Failed to read Extended File Recipe 'Recipe Number.'	Failed to read Extended File Recipe condition number, file number device value.
39	Wrong Extended File Recipe 'Recipe Number.'	If successful in reading the Extended File Recipe condition number and the file number device value, but the file or setup format does not exist.
40	Failed to read Extended File Recipe 'Block Number.'	If failed to read the Extended File Recipe block number device value.
41	Wrong Extended File Recipe 'Block Number'	When writing Extended File Recipes, succeeded in reading block number device, but block does not exist.
42	Insufficient buffer during Serializing Extended File Recipe.	Insufficient internal buffer for the Extended File Recipe feature.
43	Extended File Recipe Data Number Incorrect.	When viewing the Extended File Recipe, the written recipe data file does not match the original data.
44	Extended File Recipe Entity Number cannot be read.	When reading, the writing Extended File Recipe and the Block number of the Recipe data block number string cannot be read.
45	The Input Extended File Recipe function does not fit the buffer size.	When writing Extended File Recipes, Buffer does not fit Recipe data file character string binary conversion.
46	The recipe data file was not recorded.	Recipe data file value does not match XP-Builder User defined output format.
47	No data in Extended File Recipe file.	Extended File Recipe Entity Number cannot be read.

4.1.5 Flow Alarms

You can use flow alarms to display text at the bottom of the screen in the XGT Panel when the specified condition is met, as shown in the following figure:

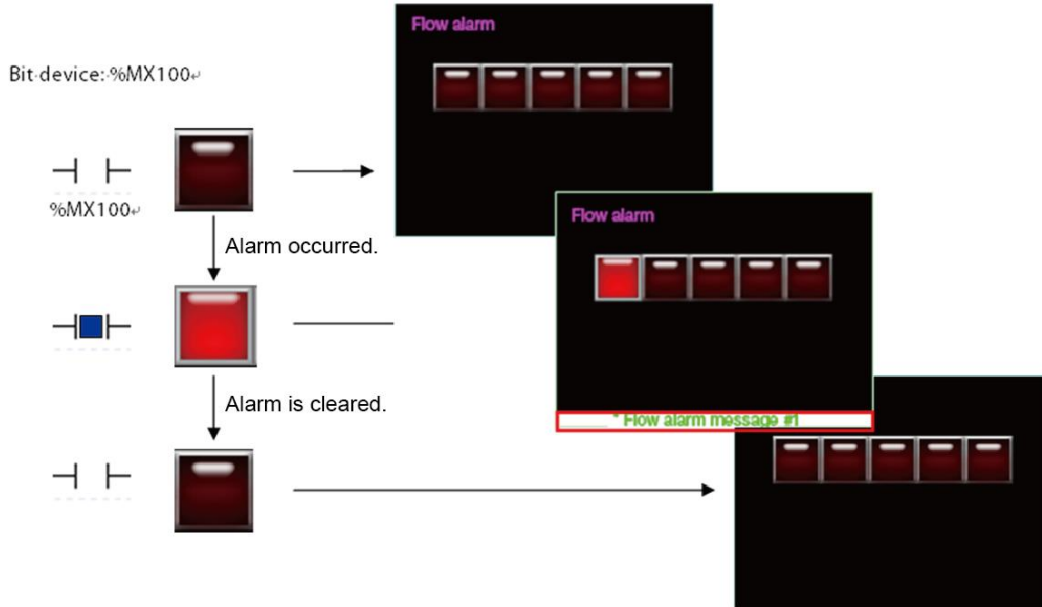

No	Device	Data Type	Bit Condition	TextTable Name	Text Index	Preview
1	%MX50	BIT	<input checked="" type="radio"/> On <input type="radio"/> Off	Text Table_01	1	Flow alarm 2 occurs!!!
2	%MX51	BIT	<input checked="" type="radio"/> On <input type="radio"/> Off	Text Table_01	2	Flow alarm 3 occurs!!!
3	%MX52	BIT	<input checked="" type="radio"/> On <input type="radio"/> Off	Text Table_01	3	Flow alarm 4 occurs!!!
4	%MX53	BIT	<input checked="" type="radio"/> On <input type="radio"/> Off	Text Table_01	4	Flow alarm 5 occurs!!!

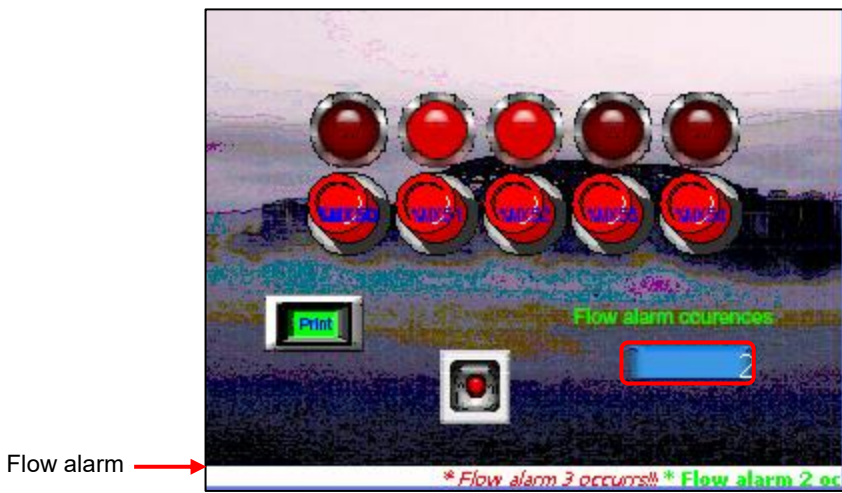

[Example: Flow alarm based on multiple bit device conditions]

To create a flow alarm:

- 1 In the Project pane, double-click [Flow Alarm].
- 2 Specify the following properties.

No	Device	Data Type	Bit Condition	TextTable Name	Text Index	Preview
1		BIT	<input checked="" type="radio"/> On <input type="radio"/> Off			
2		BIT	<input checked="" type="radio"/> On <input type="radio"/> Off			

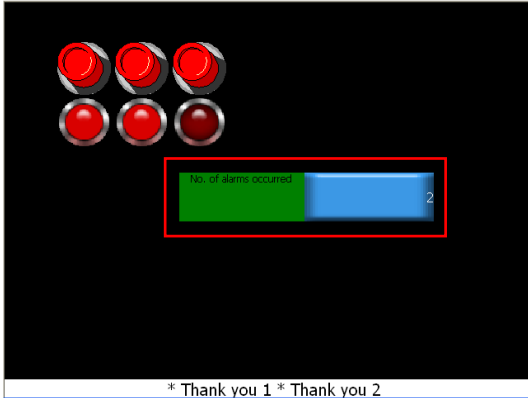
Option	Description
Device Count	Set the number of alarm devices to monitor.
Alarm Device	Set a range (continuous) or a single device to monitor.
No. of Alarm Occurred	Set a word device to save the number of alarms. It shows the total number of alarms that have occurred.  <p>* Thank you 1 * Thank you 2</p>
Background color	Set the background color for the flow alarm area
Message Position	Set the position of the flow alarm message (Below screen, Center screen, Above screen, or Set Y Position). When using the 'Set Y Position' option, the top-left pixel of the screen is '0' on the Y axis.
Display Mode	Set the display option for flow alarm changes. <ul style="list-style-type: none"> • Redraw at occurrence: The alarm message is replaced automatically with a new message. • After current display list: The alarm message remains on the screen and New or Reset alarms will be shown in subsequent messages.
Flow Speed	Set the renewal frequency of the flow alarm (2–1000 ms). The lower the number, the faster the renewal frequency.
Move pixel	Set the value for scrolling the flow alarm message (1–50 px).

Option	Description
	The larger the number, the faster the message scrolls.
Font size	Set the font size for the flow alarm message.
Message Space	Set the space between messages.
Device	Specify the device to monitor. Only bit devices can be monitored by the flow alarm.
Data type	Set the data type for the flow alarm device. If set to read-only, only the current bit device can be registered as the alarm device.
Bit Condition	Set the condition for turning the alarm on or off.
Text Table Name	Specify a text table where the flow alarm message is stored.
Text Index	Specify a text string number in the text table to use for the flow alarm message.
Preview	A preview of the flow alarm message is shown.

Note

- By default, flow alarms appear on every screen when the XGT Panel is operating.
- Up to 10,000 flow alarms can be added.
- The specified bit device is monitored continuously by the flow alarm. When the bit device is "ON", the alarm occurs and when the bit device is "OFF", the alarm is cleared.
- If more than two flow alarms occur simultaneously, the message at the bottom of the screen shows the messages in sequence.
- A flow alarm message displays text in the language specified in the project settings. The message can be shown in different languages if strings in other languages exist in the text table.

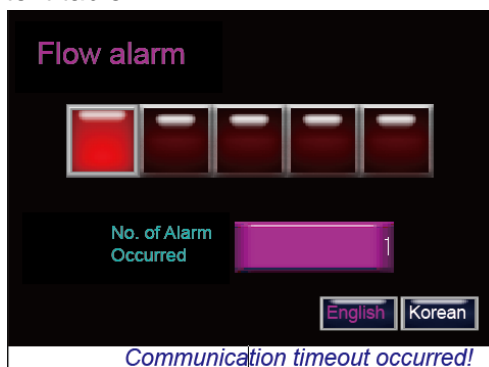

- You can set each screen not to execute a specified alarm.
- The 'Message Space' option sets the number of space characters between messages. The size of a space character may vary depending on the selected font and font size.

To set to hide flow alarms from a specific screen on the XGT Panel:

- 1 Right-click anywhere on the screen.
- 2 Click [Screen Property].
- 3 Click the **Etc.** tab and uncheck the check box next to Show Flow Alarm.

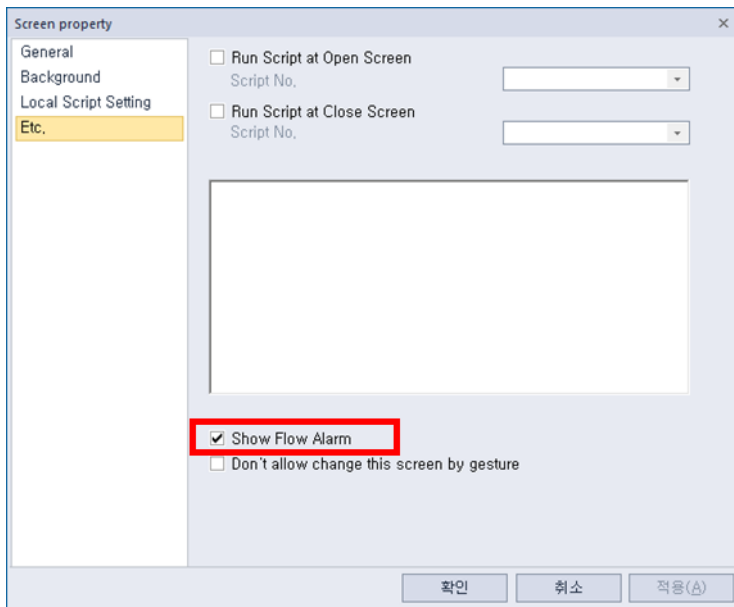

Flow alarm messages can be set in a text table and are referred from the Flow Alarm settings screen. Properties such as color or italic font can be set in a text table. A flow alarm message displays on the panel screen with the properties that are set in a text table and with a size that is set in the Flow Alarm settings screen. When you set the background color, the flow alarm area is filled with the background color.

Below is an example where the device, Flow alarm #1 (%MX1000, is ON and an alarm has occurred.

No	English (United States)	Color	Italic	Underline	StrikeOut	Bold
0	Communication timeout occurred!		On	Off	Off	Off
1	Valve #1 Off		Off	On	Off	Off
2	Valve #2 Off		Off	Off	Off	On

No	Device	Data Type	Bit Condition	TextTable Name	Text Index	Preview
1	=Flow alarm #1	BIT	<input checked="" type="radio"/> On <input type="radio"/> Off	Text Table_01	0	Communication timeout occurred!
2	=Flow alarm #2	BIT	<input checked="" type="radio"/> On <input type="radio"/> Off	Text Table_01	1	Valve #1 Off
3	=Flow alarm #3	BIT	<input checked="" type="radio"/> On <input type="radio"/> Off	Text Table_01	2	Valve #2 Off

You can see that the flow alarm message is displayed with light green italic characters according to the settings in a text table.

4. Reference

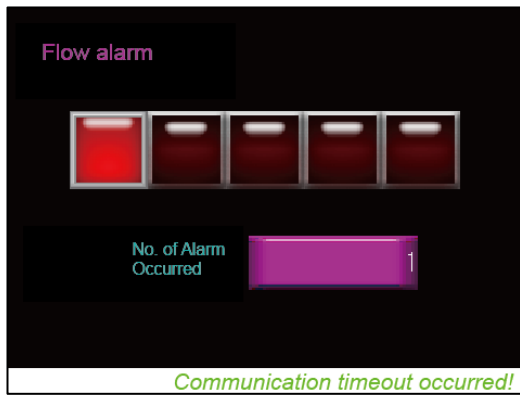

4.1.6 History Alarms

You can use history alarms to monitor or review data for the state of a device. You can view and manage history alarms with the History Alarm Viewer or Alarm Navigator objects. The History Alarm Viewer object displays a list of the alarms that have occurred and allows you to manage it. With the Alarm Navigator, you can view a list of alarms that have occurred. If there are too many alarms to view, you can filter the list by alarm group.

No.	Device	Alarm Condition	Window No.	Text Index	Alarm Count Device	Preview
1	HW00000.0	<input checked="" type="radio"/> On <input type="radio"/> Off	1	1		Gasket size invalid
2	HW00000.1	<input checked="" type="radio"/> On <input type="radio"/> Off	2	2		piston difference exceeded
3	HW00000.2	<input checked="" type="radio"/> On <input type="radio"/> Off	3	3		Detect dirt in Cylinder
4	HW00000.3	<input checked="" type="radio"/> On <input type="radio"/> Off	4	4		

History alarms are organized in alarm lists and groups. When an alarm is triggered or cleared, the time, device address, and alarm details are saved to non-volatile memory.

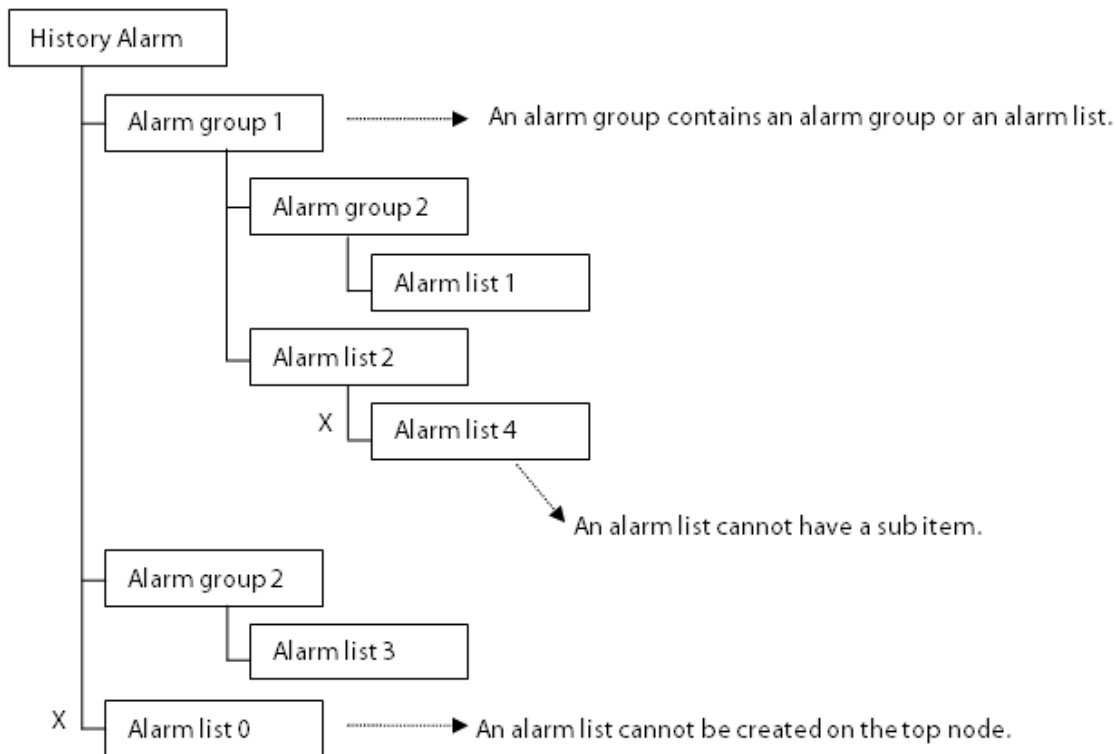

If you select the second level Alarm group 2 on the Alarm Viewer, the alarms that have occurred in Alarm list 1 will be displayed. If you select Alarm group 1, the alarms that have occurred in Alarm list 1 and Alarm list 2 will be displayed.

Note

- Up to 8 alarm groups can be created in the root structure.
- Each group in the root structure may have up to 8 alarm groups/lists.
- The maximum depth level allowed for any alarm group is 4.

To set general properties for history alarms:

- 1 In the Project pane, double-click [History Alarm]. This will open the History Alarm Property tab in the editing area.

History Alarm Property *

Backup storage path: USB memory

Clear alarm area device: ✓

Clear alarm complete device: ✓

No. of alarms occurred: D

Alarm memory full device: ✓

Non-recoverable alarm device after powering on
D

Alarm backup

Backup start device: ✓

Backup complete device: ✓ |

File type: CSV file Encrypted CSV file

File name device: D

BYTE swap of file name

File name length: 8 bytes

Send E-mail after backup complete

Remove restored alarm after backup complete

Automatic backup when memory full (Remove restored alarm)

Append/Modify data to backup CSV file
Alarm entry count of CSV file: 512

Always backup even if there were no Alarm log

Do not backup removed Alarm

Alarm print

Print start device: D

Print complete device: D

Top margin: 10 Bottom margin: 10

Left margin: 10 Right margin: 10

Font Name: T Tahoma

Alarm

Acquisition Time Table

	Time (Sec)
1	1.0
2	2.0
3	3.0
4	4.0
5	5.0
6	6.0
7	7.0
8	8.0
9	9.0
10	10.0

2 Specify the following properties.

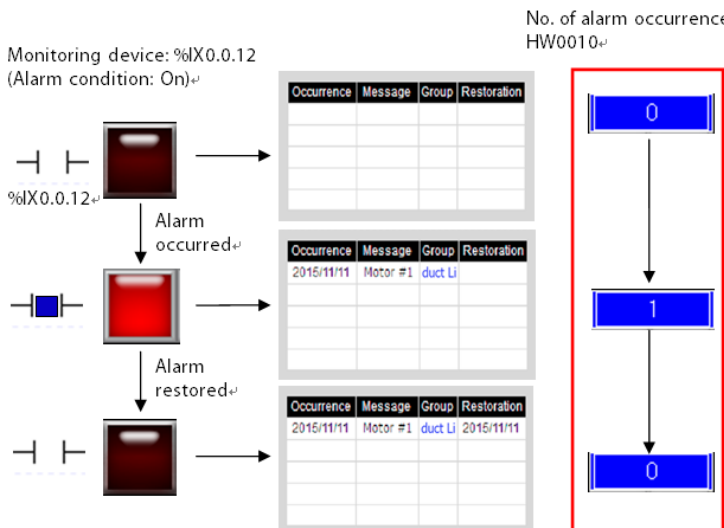
Option	Description																																																												
Backup Storage Path	Set a location for the history alarm backup. Refer to <4.7.1 Managing the File Path for Backup Files> for more information about storing backup files.																																																												
Clear Alarm Area Device	Specify a device to initialize the history alarm area in the NVRAM.																																																												
Clear Alarm Area Complete Device	Specify a device to activate after initializing the history alarm area in the NVRAM is complete.																																																												
No. of Alarms Occurred	<p>Specify a device to save the number of alarms that have occurred.</p> <p style="text-align: right;">No. of alarm occurrence: HW0010^v</p>  <p>Monitoring device: %lX0.0.12 (Alarm condition: On)^v</p> <p>%lX0.0.12^v</p> <p>Alarm occurred^v</p> <p>Alarm restored^v</p> <table border="1" data-bbox="885 862 1141 996"> <thead> <tr> <th>Occurrence</th> <th>Message</th> <th>Group</th> <th>Restoration</th> </tr> </thead> <tbody> <tr><td> </td><td> </td><td> </td><td> </td></tr> <tr><td> </td><td> </td><td> </td><td> </td></tr> <tr><td> </td><td> </td><td> </td><td> </td></tr> <tr><td> </td><td> </td><td> </td><td> </td></tr> </tbody> </table> <table border="1" data-bbox="885 1019 1141 1153"> <thead> <tr> <th>Occurrence</th> <th>Message</th> <th>Group</th> <th>Restoration</th> </tr> </thead> <tbody> <tr> <td>2015/11/11</td> <td>Motor #1</td> <td>duct Li</td> <td> </td> </tr> <tr><td> </td><td> </td><td> </td><td> </td></tr> <tr><td> </td><td> </td><td> </td><td> </td></tr> <tr><td> </td><td> </td><td> </td><td> </td></tr> </tbody> </table> <table border="1" data-bbox="885 1176 1141 1310"> <thead> <tr> <th>Occurrence</th> <th>Message</th> <th>Group</th> <th>Restoration</th> </tr> </thead> <tbody> <tr> <td>2015/11/11</td> <td>Motor #1</td> <td>duct Li</td> <td>2015/11/11</td> </tr> <tr><td> </td><td> </td><td> </td><td> </td></tr> <tr><td> </td><td> </td><td> </td><td> </td></tr> <tr><td> </td><td> </td><td> </td><td> </td></tr> </tbody> </table>	Occurrence	Message	Group	Restoration																	Occurrence	Message	Group	Restoration	2015/11/11	Motor #1	duct Li														Occurrence	Message	Group	Restoration	2015/11/11	Motor #1	duct Li	2015/11/11												
Occurrence	Message	Group	Restoration																																																										
Occurrence	Message	Group	Restoration																																																										
2015/11/11	Motor #1	duct Li																																																											
Occurrence	Message	Group	Restoration																																																										
2015/11/11	Motor #1	duct Li	2015/11/11																																																										
Alarm Memory Full Device	The device is set to ON when there is insufficient memory in the history alarm domain.																																																												
Non-recoverable alarm device after powering on	Designate the device to show the unrecovered of the alarms that occurred after power on.																																																												
Alarm backup	Click the checkbox to configure the Backup Start/Complete devices.																																																												
Backup Start Device	Specify a device to begin backup of alarm data. Backup will only be performed if the backup location in the project properties is set to a USB device or CF card.																																																												
Backup Complete Device	Specify a device to activate when alarm data backup is complete.																																																												

Option	Description
File type	<p>Select the type of backup file (CSV or CSVE). A CSV file can be opened using applications such as Memo Pad and MS Excel. An encrypted CSV file (with the file extension CSVE) can be converted to a CSV file Using the CSV Converter ([Tool] ► [CSV file converter]). Refer to <4.6 Using the CSV Converter> for more details.</p>
File Name Device	<p>The name of the backup file can be changed. The character string of the device is used as the file name.</p>
BYTE Swap of File Name	<p>When a file is saved, the bytes are swapped. For example, if the value stored in the device is "H12345678", the swapped bytes will be "H21436587".</p>
File Name Length	<p>Specifies the number of character strings in the file name.</p>
Send E-mail After Backup Complete	<p>Set to send an email when backup of alarm data is complete. To use this function, you must specify backup start and backup complete devices. An email address specified in [Project Properties] ► [Others] ► [Email].</p>
Clear Restored Alarm After Backup Complete	<p>Set to allow cleared alarms to be removed from the NVRAM after a backup is completed.</p>
Automatic Backup when Memory Full	<p>If there is not enough memory capacity in the alarm area, the alarms are automatically backed up.</p>
Append/Modify Data to Backup CSV File	<p>The alarm back up is added to the most recently saved CSV file.</p>
Alarm Entry Count of CSV File	<p>The maximum number of alarms in the backup file is specified.</p>
Always Backup even if there were NO Alarm Log	<p>The alarm backup file is created even when there is no alarm history.</p>
Do Not Backup Removed Alarm	<p>Deleted alarms in the history alarm are not included in the alarm backup.</p>
Alarm Print	<p>Set to print history alarm data.</p>
Print Start Device	<p>Specify a device to start printing history alarm data.</p>
Print Complete Device	<p>Specify a device to activate when printing history alarm data is complete.</p>
Top, Bottom, Left, and	<p>Specify margins for printing history alarm data.</p>

Option	Description
Right margins	
Acquisition Time Table	Set intervals for collecting history alarm data.

Note

About the Acquisition Rate Table:

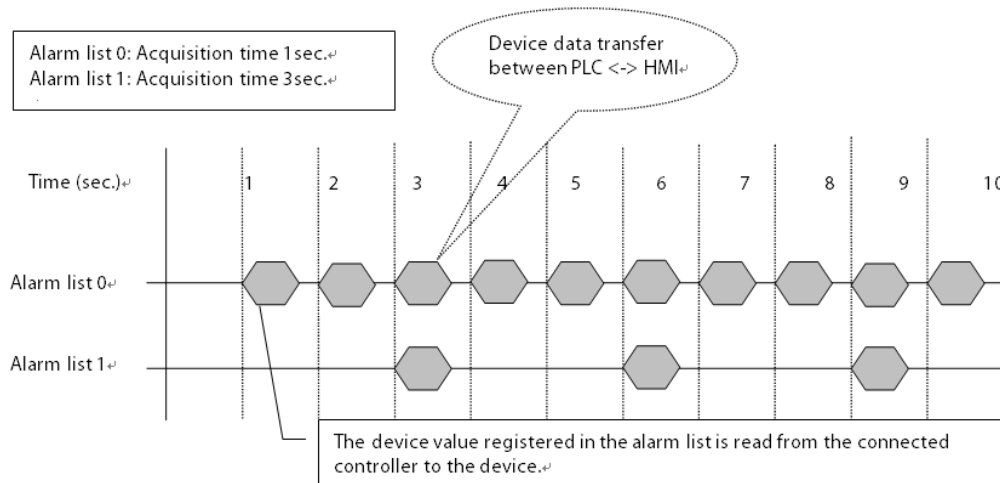

- Set up to 10 different sampling time for collecting history alarm data.
- The sampling time can be set between 1–10 seconds with a minimum unit scale of 0.1 seconds.
- In the alarm list, you can select the sampling times you set here, to allow for flexible acquisition cycles for different types of devices.
- An XGT Panel inspects the alarm list and acquisition cycles together. Therefore, a large number of acquisition cycles in a project can slow performance.

To add an alarm group:

- 1 In the Project pane, right-click [History Alarm].

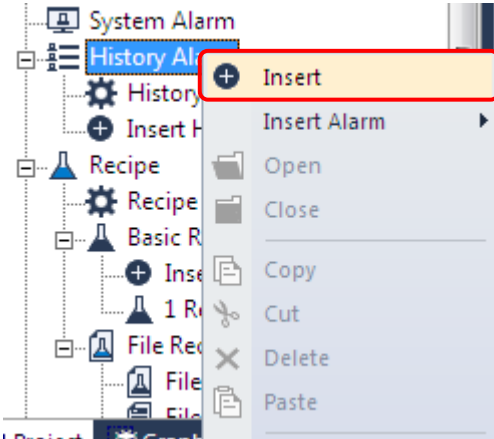

- 2 Click [Insert]. An Alarm Group tab will appear in the editing area.

Group name:

Group ID:

Display Name

From Text table: No.:

Preview:

Manually input:

Synchronize manually input name with History Alarm Group Name of Project tree

- 3 Specify the following properties for the alarm group:

Option	Description
Group Name	The name of the alarm group.
Group ID	The ID number of the alarm group.
Display Name	Select either From Text Table to fetch a group name from a text table, or Manually Input to provide a group name manually. If you fetch a name from a text table, set the No. (String number) value to identify the correct string in the table. The group name will appear in the Preview field. Click the checkbox next to Synchronize manually input name... to update the alarm group name in the Project pane.

To create a history alarm:

- 1 In the Project pane, right-click a history alarm group.

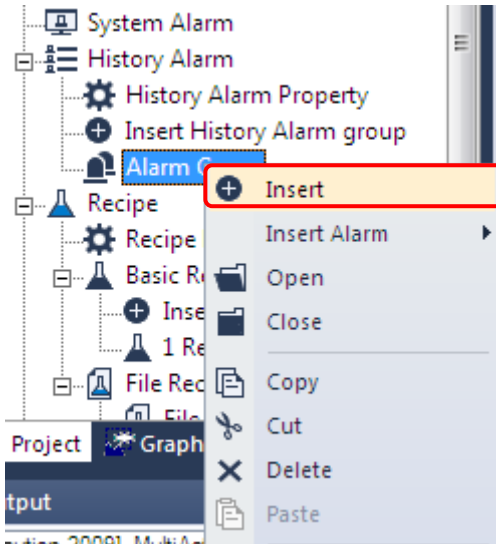

- 2 Click [Insert]. An Alarm List tab will appear in the editing area.

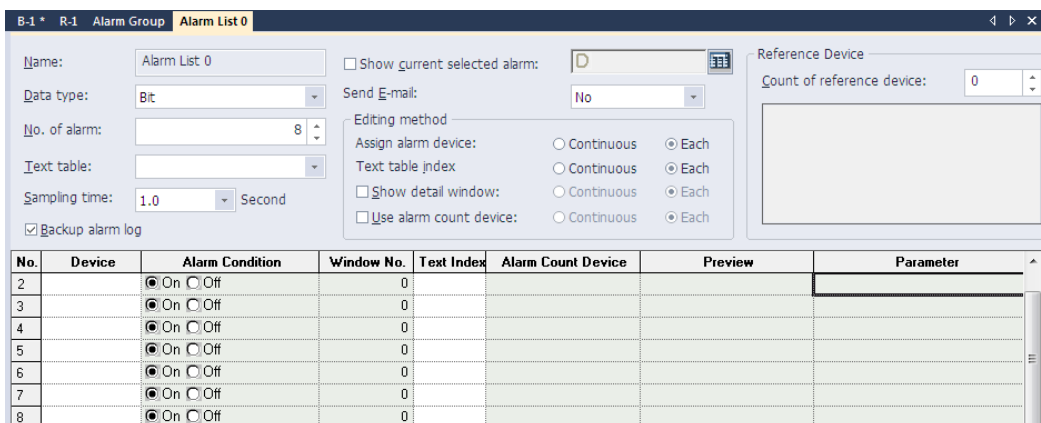

- 3 Set the following properties for the alarm list:

Option	Description
Name	The name of the alarm list.
Data Type	Set the device type (bit or word).
No. of alarm	Set the number of alarms (maximum 10,000).
Text Table	Select a text table to fetch text from.
Sampling Time	Set how often to check for alarm conditions (1–10 seconds). The dropdown list provides time values as configured in the Acquisition Rate Table.
Backup Alarm Log	By default, history alarm data is cleared if you check Delete all monitoring data when you partially download a project, or when you download an entire project.

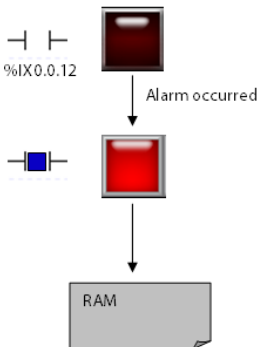
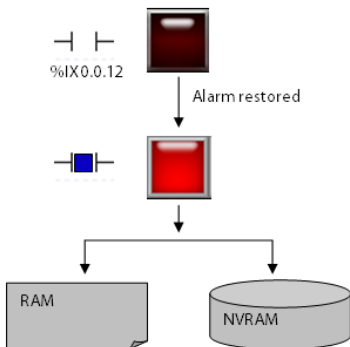
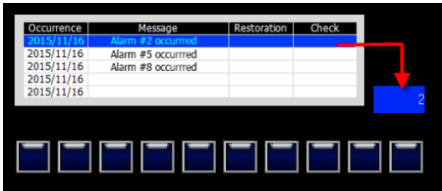
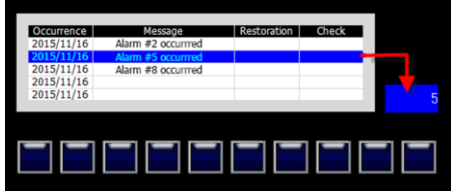
Option	Description
	<p>To save history alarm data in the SRAM, set the Backup alarm log function. The Backup alarm log function saves the alarm data as a CSV file when the alarm backup device is turned on.</p> <p>If a power interruption to the panel occurs, you cannot trace the alarm via the History Alarm Viewer when the power is resumed although it has not been cleared, and it is listed in the CSV file as “Untraceable.”</p> <div style="display: flex; justify-content: space-around;"> <div style="text-align: center;"> <p>When Backup Alarm Log is On</p>  </div> <div style="text-align: center;"> <p>When Backup Alarm Log is Off</p>  </div> </div>
<p>Show Current Selected Alarm</p>	<p>Specify a device to display the most recent alarm. You can enter the device address manually or click the keypad icon to the right of the device field.</p> <div style="display: flex; justify-content: space-around;">   </div>
<p>Send E-mail</p>	<p>Set to enable an email notification for the history alarm (Occur/Restore/Both) or to disable it (No). For more details about email settings, refer to <2.2.2.9 Changing Auxiliary Setting>.</p> <p>The Following is the email for alarm occurrence/restoration notification.</p> <div style="border: 1px solid black; padding: 10px; margin: 10px 0;"> <pre> * History alarm Information [Device Alias] ... [Alarm group name] ... [Alarm message] ... [Alarm State] Occurred [Time] ---/--/-- --/--/-- </pre> </div> <p>An email notification for alarm is backed up is as follows.</p>

Option	Description
	<div style="border: 1px solid black; padding: 5px;"> <p>* Alarm data has saved as CSV.</p> <p>[Device alias]</p> <p>[File Path]</p> </div>
Assign Alarm Device	Set the method for specifying alarm devices.
Text Table Index	Set the method for specifying strings in text tables.
Show Detailed Window	Set the method for specifying windows and whether or not to show detailed information.
Use Alarm Count Device	Set whether or not to use a device to save alarm count data and the method for specifying devices.
Count of Reference Device	Set the number of the reference device (0-10).
Parameter	<p>This option specifies whether a parameter will be used. If it is checked, the parameter can be edited in the alarm list. The stored parameters are sent to an external program if the external program is run by a special switch for the external program. Refer to <4.3.2.4 Special Switch> for more information.</p> <p>After selecting Parameter, you can set the following options.</p> <ul style="list-style-type: none"> • Save at: It specifies the device to store the input parameters when a history alarm record is selected in the view history alarm object. • Type: Set the parameter type (file name, text, or number) and the device to store the parameter data. If File name is selected, you can also set the external storage where the file is located. • File Name Position: Set the user input parameter to be stored as a file on a USB drive, CF or SD cards (availability may vary depending on the XGT Panel model). • Text: Set the user input parameter in the history alarm list to be stored in a text format. • Number: The user input parameters in the history alarm list are converted into a number based on the user's selected number type. Then, it is stored in the storage device. The number type can be selected among unsigned 16 bits, signed 16 bits, unsigned 32 bits, or signed 32 bits.
Device	Enter alarm device addresses.
Alarm Condition	Set the alarm condition. For bit devices, the condition is either on or off. For word devices, the condition is an expression.
Window No.	The number of the detailed window is displayed if you selected View

Option	Description
	detail window option.
Text Index	Specify the index of a string from a text table.
Alarm Count Device	The alarm count device is displayed if you selected the Use alarm count device option.
Reference Device	Set the number of reference devices and define them.
Preview	The selected text string for the alarm, if applicable.

To define the range for an alarm expression, specify the following settings.

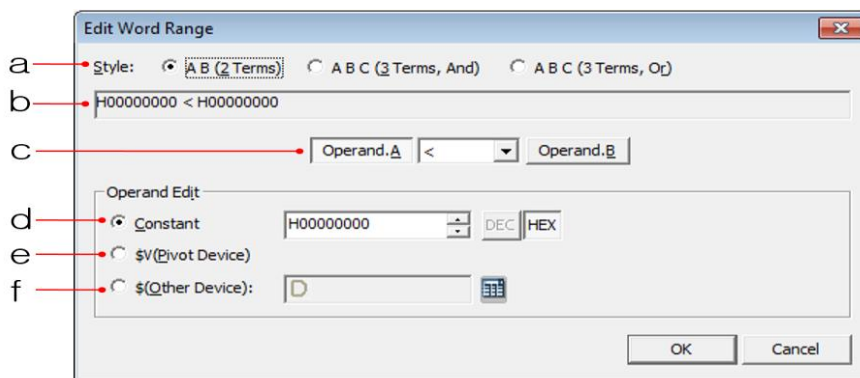

Symbol	Function	Description
a	Style	Select a form for the expression. Examples for each style are as follows: <ul style="list-style-type: none"> A B (2 Terms): $0 < 0$ A B C (3 Terms, And): $0 \leq \text{Device Value} < 100$ A B C (3 Terms, Or): $10 > \text{Device Value}$ OR $\text{Device Value} > 100$
b	Preview Conditional Sentence	Displays a preview of the conditional expression.
c	Conditional Expression Editing item	Select the operand you want to modify and set the operator.
d	Constant	Set the operand type at a fixed value.
e	\$V (Standard Device)	Use the current alarm monitoring device as an operand in the expression. Displayed as \$V in the preview.
f	\$ (Other Device)	Specify another device value as an operand in the expression.

Note

If a word device is set as the alarm monitoring device, an alarm condition is required. The alarm

condition is a single conditional expression consisting of two or three terms, linked by *and* or conditions.

Conditional expressions must meet the following requirements:

- Each term should be separated by a blank space.
- The standard device address is expressed by "\$V." If "\$V" is entered, it is automatically recognized as the standard device when the project is transferred to an XGT Panel. The current alarm monitoring device must be included at least once in the expression.
- Each conditional expression must include at least one direct variable (device variable).
- The available operators are: < ,> , <= , >= , =, and !=

When a monitoring device detects that the alarm condition is met (on or off states for bit devices, specific expression for word devices), a history alarm occurs, and the time and content of the alarm is displayed in a history alarm viewer object. When a monitoring device detects that the alarm condition is cleared, the time of alarm clearance will be displayed in a history alarm viewer object.

4. Reference

Monitoring device: %IW0.1.0

Alarm condition
 $\%IW0.1.0 < 0$ or $100 < \%IW0.1.0$

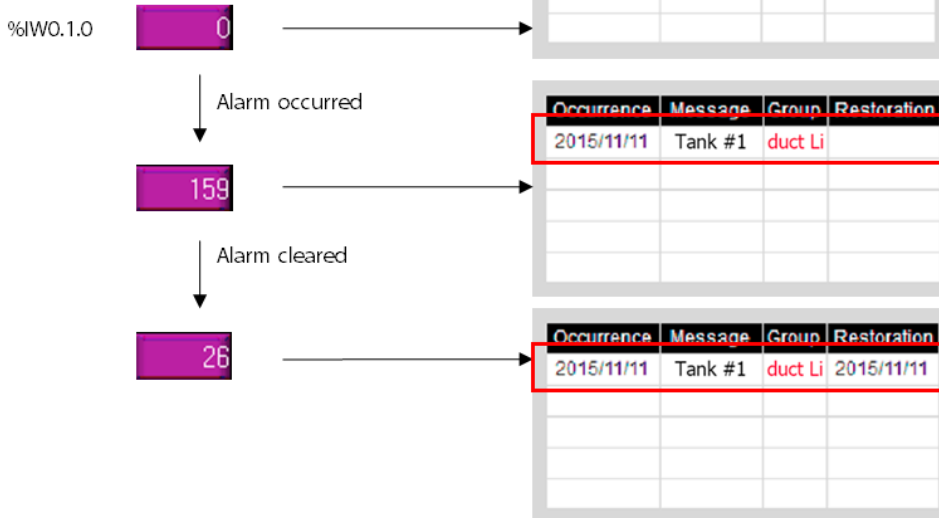

Monitoring device: %IX0.0.12 (Alarm condition: On)

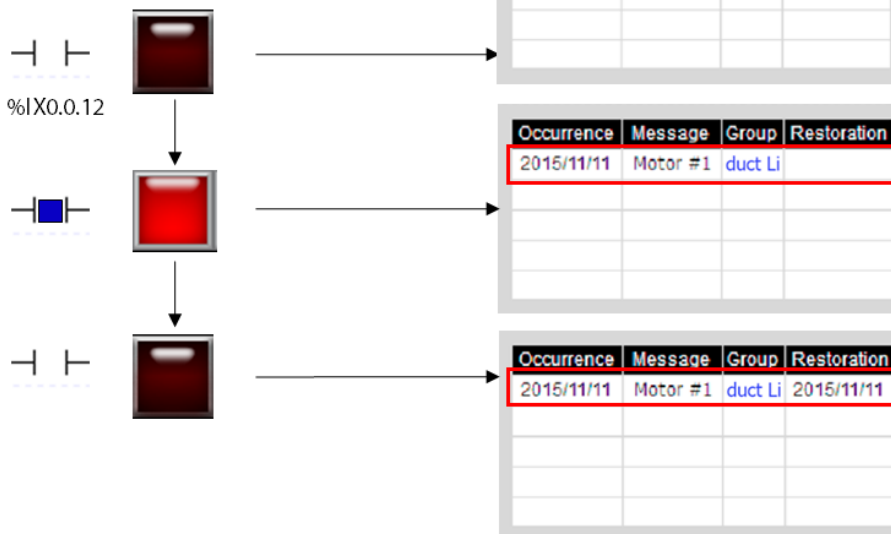

History alarms are saved in the order of occurrence. If the same alarm occurs more than once, it will be saved several times in the alarm count device.

Because the acquisition time for each history alarm and the number of registered devices do not match, the time of alarm occurrence may differ.

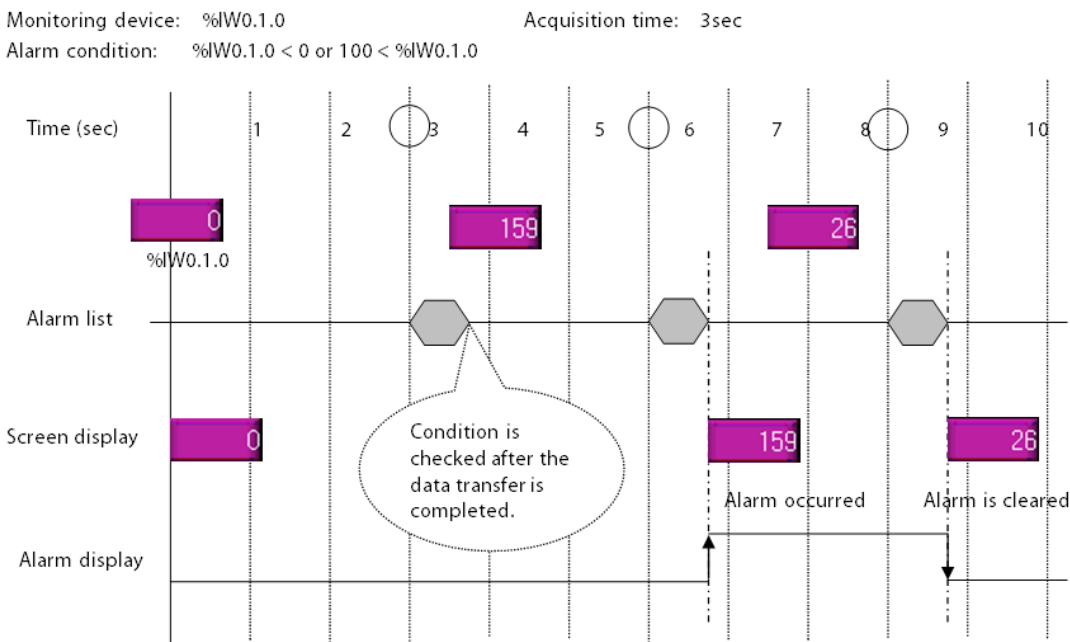
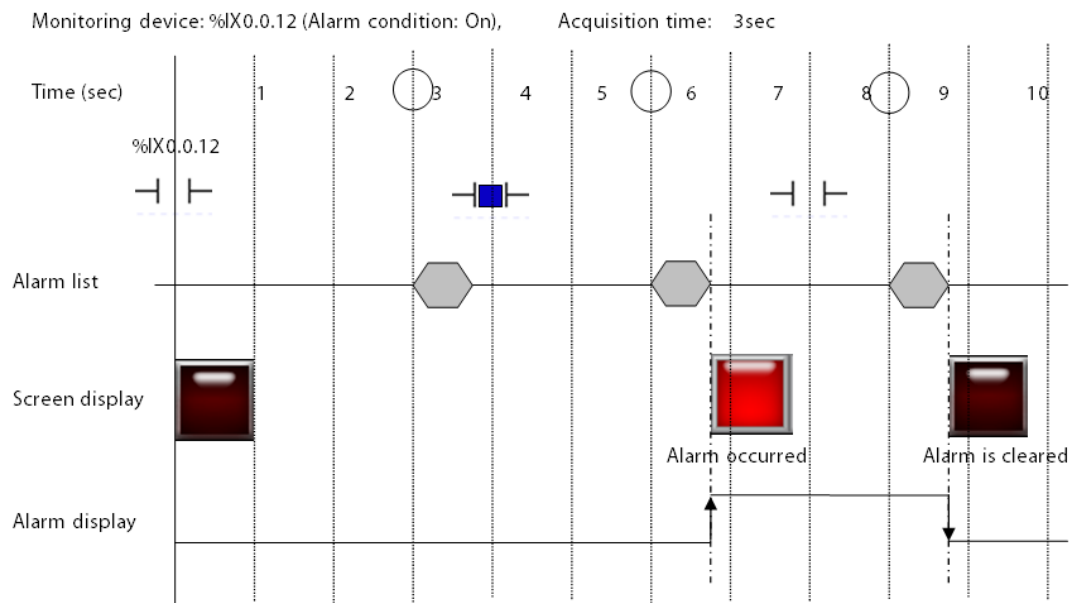

The History Alarm Viewer object displays a list of the alarms that have occurred. If many alarms occurred and you want to refer to only a certain group, you can use the alarm Navigator object to view only the desired alarm group.

You can add a window to view the detailed information of an alarm.

To add a window:

- 1 From the alarm list, click the check box next to **Show detail window**.

- 2 Enter a window number for each alarm.

No.	Device	Alarm Condition	Window No.
1	P0000		1
2	P0002		2
3	P0004		3
4	P0006		4
5	P0008		5

- 3 In the Project pane, edit the detailed window.
- 4 Create a special switch for the alarm list edit window, and select **Go to History Alarm Viewer Detail** in the **Special Switch Function** settings.

- 5 Select an alarm from the alarm viewer object, and click the special switch to open the detailed information window.

Note

Alarm messages for history alarms are referred from text tables. Text properties, such as font color, that are set in a text table will also be applied.

You can print the list of history alarms using a special switch after connecting a USB printer to the device. Refer to <**4.3.2.4 Special Switch**> for more information.

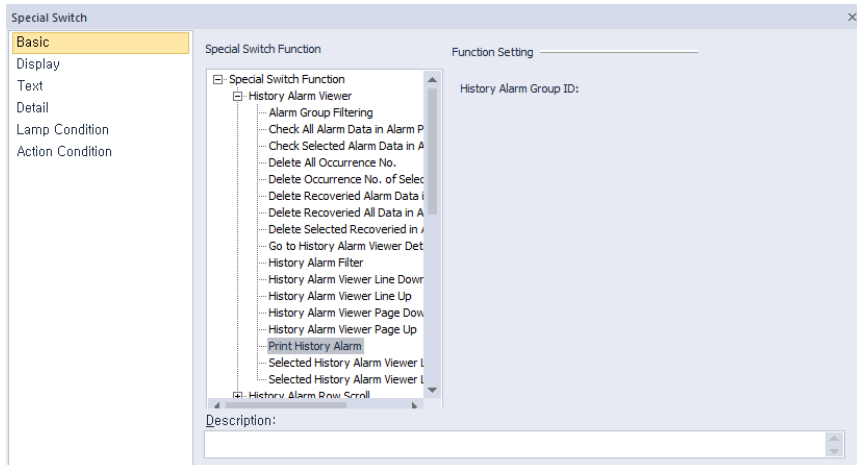

4.1.7 Schedules

You can use schedules to specify actions in advance. Available functions for schedules include Bit On, Bit Off, Word value setting, script execution, and more. You can create up to 32 schedules and each schedule can specify up to 8 actions.

The following example explains how scheduling works:

[The Bit On function switches on the device based on a schedule]

The screenshot shows the 'Scheduler' window with a table containing one entry:

No	Type	Value	Description
1	Every minute	Run every minute 59s.	Bit ON

Below the table is the 'Property' dialog box for the selected schedule. It shows 'Type: Every minute' and 'Description: Bit ON'. Under 'Function Settings', the 'Function' list includes 'Bit On', 'Bit Off', 'WORD Set', 'DWORD Set', and 'Script'. The 'Bit On' function is selected, and its details are shown in a sub-table:

No	Type	Description
00	Bit On	Bit Device =%mx01 On

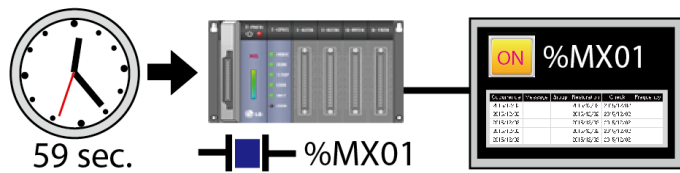

[The Bit Off function switches off the device on the schedule]

The screenshot shows the 'Scheduler' window with a table containing one entry:

No	Type	Value	Description
1	Every minute	Run every minute 59s.	Bit OFF

Below the table is the 'Property' dialog box for the selected schedule. It shows 'Type: Every minute' and 'Description: Bit OFF'. Under 'Function Settings', the 'Function' list includes 'Bit On', 'Bit Off', 'WORD Set', 'DWORD Set', and 'Script'. The 'Bit Off' function is selected, and its details are shown in a sub-table:

No	Type	Description
00	Bit Off	Bit Device =%mx01 Off

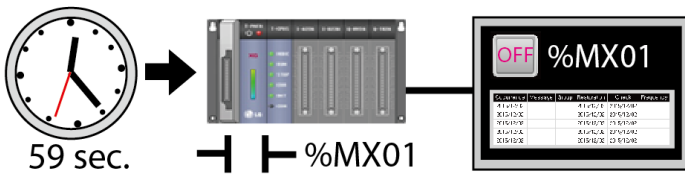

[The WORD Set function writes a value on the word device at the scheduled time.]

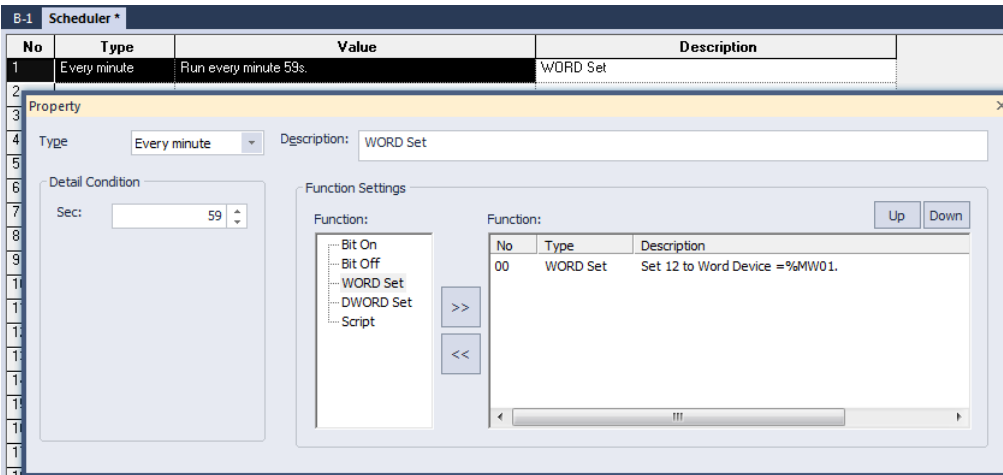

[The Script function executes a designated script at the scheduled time.]

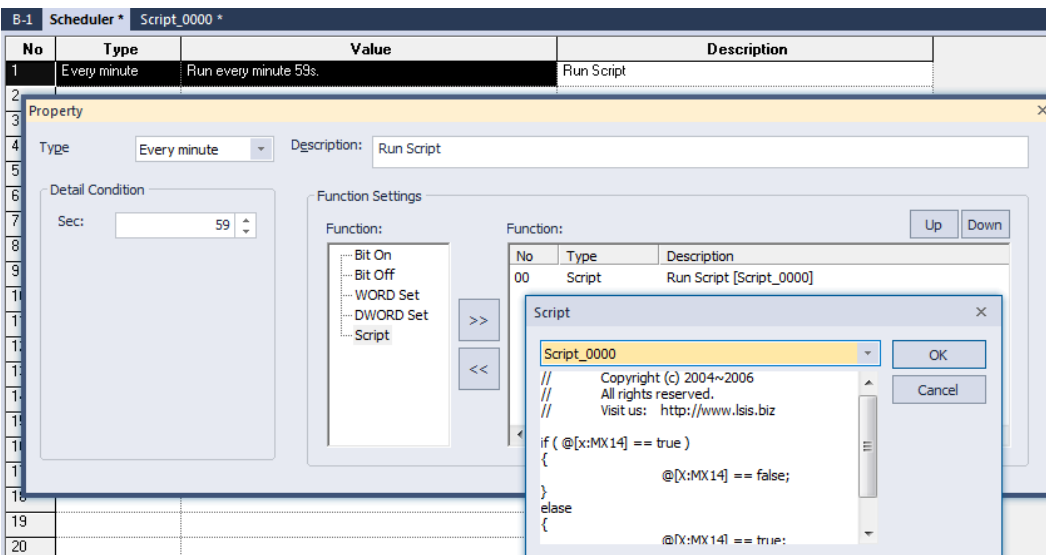

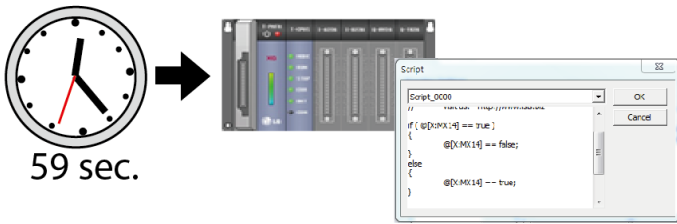

To create a schedule:

- 1 Click an object in the editing area.
- 2 In the Project pane, double-click [Scheduler]. This will open the **Scheduler** tab in the editing area.
- 3 Double-click anywhere in the **Scheduler** tab to open the Property window.

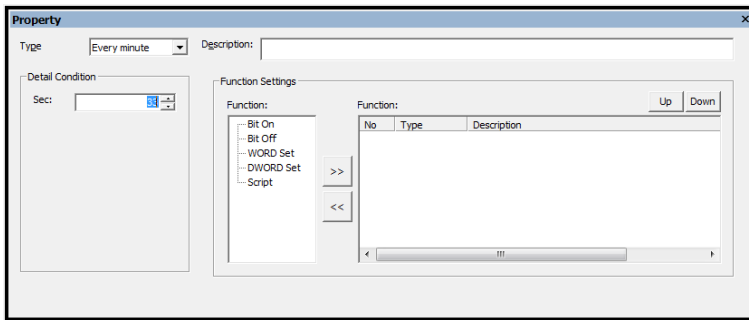

4 Specify the following properties:

Type	Description
Type	Set the operation interval (Every minute/hour/day/week/month/year, or Once).
Detail Condition	Set the detailed operation time, based on the operation interval (seconds, minutes, hours, date, week of the day, etc.).
Description	Enter a description for the schedule.
Function	<p>Click a function and then click [>>] to add the function to the schedule. Click a function and then click [<<] to remove a function from the schedule. You can specify up to 8 functions in a schedule.</p> <div style="display: flex; justify-content: space-around;"> <div data-bbox="416 1626 689 1928"> </div> <div data-bbox="703 1626 976 1928"> </div> <div data-bbox="991 1626 1264 1928"> </div> </div> <ul style="list-style-type: none"> • Device: Set the bit or word (16-bit or 32-bit) device to enter a value when the function starts.

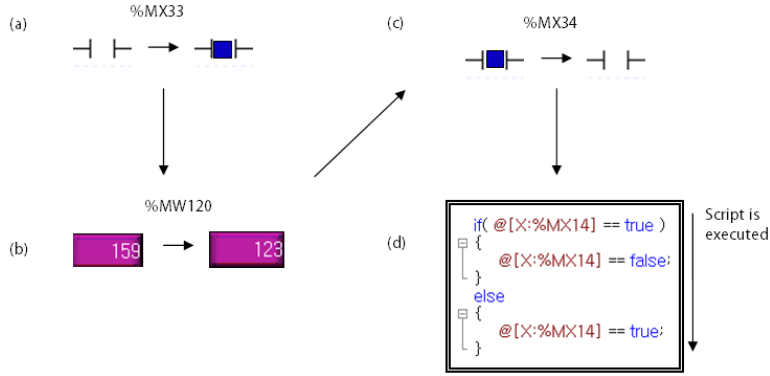
Type	Description															
	<ul style="list-style-type: none"> • Data type: Set the data type to enter to the device. • Value: Set the value to enter in the device. 															
Up/Down	<p>Click [Up] or [Down] to arrange the operation sequence by prioritizing functions.</p> <table border="1" data-bbox="427 510 831 622"> <thead> <tr> <th>No</th> <th>Type</th> <th>Description</th> </tr> </thead> <tbody> <tr> <td>00</td> <td>Bit On</td> <td>Bit Device %MX33 On</td> </tr> <tr> <td>01</td> <td>WORD Set</td> <td>Set 123 to Word Device %MW120.</td> </tr> <tr> <td>02</td> <td>Bit Off</td> <td>Bit Device %MX34 Off</td> </tr> <tr> <td>03</td> <td>Script</td> <td>Run Script [Script_0001]</td> </tr> </tbody> </table>  <p>(a) Bit Device %MX33 On: A pulse is applied to %MX33, turning a blue square on.</p> <p>(b) WORD Set: The value of %MW120 changes from 159 to 123.</p> <p>(c) Bit Device %MX34 Off: A pulse is applied to %MX34, turning a blue square off.</p> <p>(d) Script execution: An if-else script is shown. The condition '@[X:%MX14] == true' is false, so the 'else' branch '@[X:%MX14] == true:' is executed. A label 'Script is executed' points to the script box.</p>	No	Type	Description	00	Bit On	Bit Device %MX33 On	01	WORD Set	Set 123 to Word Device %MW120.	02	Bit Off	Bit Device %MX34 Off	03	Script	Run Script [Script_0001]
No	Type	Description														
00	Bit On	Bit Device %MX33 On														
01	WORD Set	Set 123 to Word Device %MW120.														
02	Bit Off	Bit Device %MX34 Off														
03	Script	Run Script [Script_0001]														

4.1.8 Sounds

You can specify a maximum of 512 WAV or MP3 files to play when conditions are met for the XGT Panels other than the iXP/IPC series models. To hear sounds, you must connect a speaker to the sound output port.

Below is an example of how a sound is used.

Switch

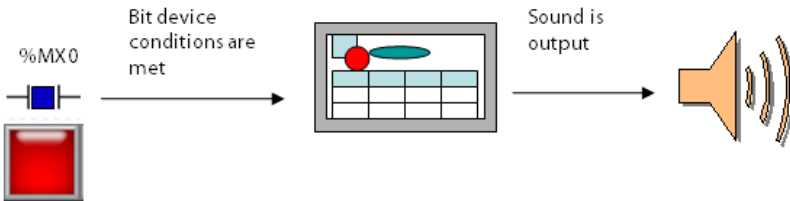

Script

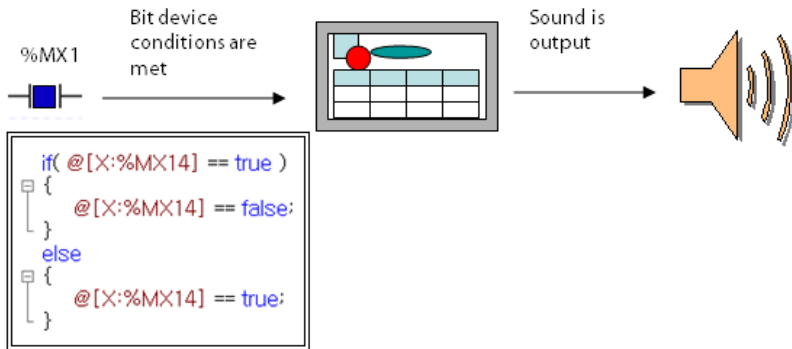

To create a sound:

- 1 In the Project pane, double-click [Sound]. This will open a Sound tab in the editing area.

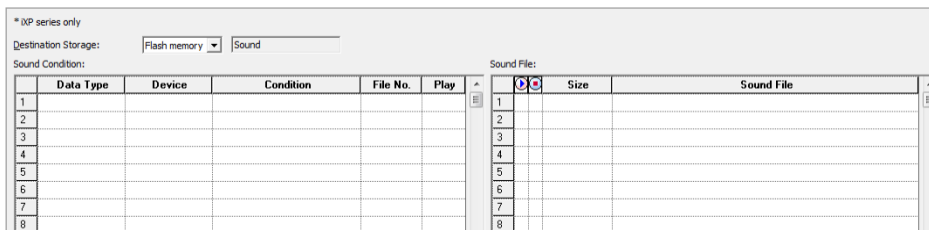

- 2 Specify the following conditions:

Function	Description
Destination Storage	Select a storage location for the sound file. You can also set the location at the Project Property window.
Data Type	Enter the data type (e.g., 16-bit signed).
Device	Enter the device that will activate the sound file.
Condition	Enter a condition for running the sound file. Choose ON/OFF for bit devices and enter a condition formula for other types of

Function	Description
	devices.
File No.	Enter the file number of the sound file.
Play	Select a play mode for the sound file.
	Play or stop the sound file.
Size	Display the size of the sound file (KB/MB).
Sound File	You can select the sound file to play from the browsing window. The file path and file name are displayed after you have selected the file.

Note

- MP3 files may not play if the sound codec is not supported by your PC. Install the proper codecs to play sound files.
- MP3 files must have the following characteristics: MPEG 1, Layer III, Sample rate: 32-48 KHz, Bit rate: 32-320 kbps.
- WAV files must have the following characteristics: Raw PCM Audio, 8/16 bit, signed/unsigned, Stereo/Mono.
- Sound files cannot exceed 10 MB.

4.2 Scripts

Instead of creating individual objects and assigning operations to them, you can program global operations using scripts in the XP-Builder interface.

4.2.1 About Scripts

Scripts perform specified actions based on inputs from a user or from the system. You can control the system entirely with figures and objects in the XP-Builder interface, but using scripts allows you to organize the project more conveniently and effectively. Script characteristics include:

- Easy system management
- Control of screens with clearly defined functions and complex mathematical operations
- Simplified programming (based on a limited form of the C language)
- Simplified editing, provided by a general program editor
- Debugging in the program editor for verifying grammatical errors in scripts
- Utilizes user-defined protocol drivers to transfer data to and from a controller

Scripts are executed as shown in the following table.

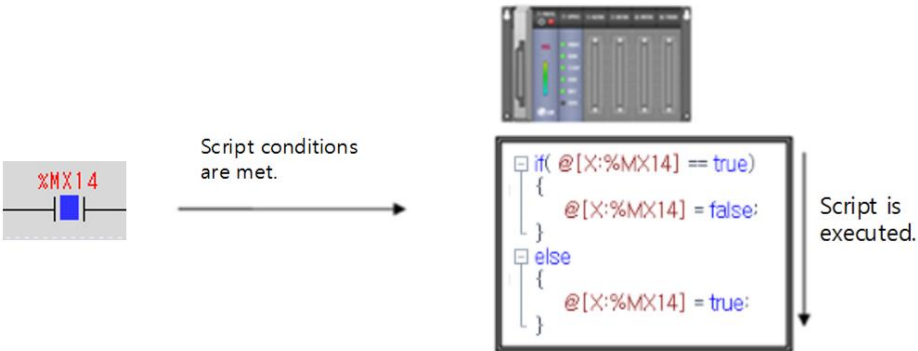
Script Type	Execution Method
Global	<p>When the conditions are met, the script controls or manages the entire project and its components.</p> 
Display Change	When the current screen is closed and before a new screen is opened.

Script Type	Execution Method
Local Settings	<ul style="list-style-type: none"> • When the script conditions set in the current screen are met. • Set the scripts only for the screen.
Scheduler	<p>Operation at the specified time</p>
Objects	<p>Based on the action defined for the object only in the current screen.</p> <p>Number input</p>

4.2.1.1 Understanding Script Commands

Learn how to write commands with scripts. The following table describes the control statements and operators available for programming scripts:

Command	Expression	Description
<ul style="list-style-type: none"> Control Statements 		
if	<pre>if (Condition) { Statement; } else { Statement; }</pre>	<p>This command performs the statement if true (a value other than 0) as a result of judgment of the condition and shifts to the location next to the statement if false.</p> <p>[Example]</p> <pre>6 const int Number = 50; 7 int nindex, ntotal; 8 9 ntotal = 0; 10 11 if(0 != nindex%2) 12 { 13 ntotal += nindex; 14 } 15 \$L = ntotal;</pre> <pre>6 @[0:w:HW0000] = 10; 7 @[0:w:HW0001] = 0; 8 if(@[0:w:HW0000] > 0 && @[0:w:HW0001] > 0) 9 @[0:w:HW0002] = 10; 10 else @[0:w:HW0002] = 20;</pre>
for	<pre>for(Expression; Condition; Expression) { Statement; }</pre>	<p>This command repeats the statement if true (a value other than 0) as a result of judgment of the condition and shifts to the location next to the statement if false.</p> <p>[Example]</p> <pre>7 const int Number = 0; 8 int ntotal, nindex; 9 ntotal = 0; 10 for(nindex = 2 ; nindex <= Number ; nindex++){ 11 ntotal += nindex; 12 } 13 \$L=ntotal;</pre>
while	<pre>while(Condition) { Statement; }</pre>	<p>This command repeats the statement if true (a value other than 0) as a result of judgment of the condition and shifts to the location next to the statement if false.</p> <p>[Example]</p> <pre>6 int nindex, ntotal = 0; 7 while (nindex < 5) { 8 nindex++; 9 ntotal += nindex; 10 } 11 \$L = ntotal;</pre>
do while	<pre>do { Statement; } while(Condition);</pre>	<p>This command shifts to the Do location and performs the statement if true (a value other than 0) as a result of judgment of the condition and shifts to another location if false.</p> <p>[Example]</p>

Command	Expression	Description
		<pre> 7 const int Max = 20; 8 int List[20], nindex = 0, Number, Temp; 9 bool Sorted; 10 11 do{ 12 List[nindex] = nindex; 13 nindex++; 14 }while(nindex != Max); 15 16 Number = nindex; 17 Sorted = false; 18 while((Number > 1) && !Sorted){ 19 Sorted = true; 20 for(nindex = 0; nindex <= Number - 2; nindex++){ 21 if(List[nindex] > List[nindex + 1]){ 22 Sorted = false; 23 Temp = List[nindex]; 24 List[nindex] = List[nindex+1]; 25 List[nindex+1] = Temp; 26 } 27 Number = Number - 1; 28 } </pre>
return	return;	<p>Ends the script.</p> <p>[Example]</p> <pre> 7 const int Number = 0; 8 int index, size; 9 10 for(index = 2 ; index <= Number ; index++){ 11 size += index; 12 13 return; 14 } </pre>
break	break;	<ul style="list-style-type: none"> • The break statement within the loop gets out of the loop wrapping the break. • If the break statement is within the nested loop, it only affects the loop which is furthest inward in the program. <p>[Example]</p> <pre> 7 int Sensor_0, Sensor_1, Light ; 8 9 while(Light <=200){ 10 Sensor_0 ++ ; 11 Sensor_1 ++ ; 12 Light = Sensor_0 + Sensor_1 ; 13 14 if(Light ==199){ 15 16 Backlight(true); 17 18 break; 19 } 20 } 21 HMIExit(); 22 </pre>
continue	continue;	<ul style="list-style-type: none"> • Skips the remaining part within the loop and shifts to the next loop execution. • The continue statement is within the nested loop, it only affects the internal loop structure containing it. <p>[Example]</p>

Command	Expression	Description
		<pre> 7 int Sensor_0, Light ; 8 int counter = 0, Sensor_0 = 0; 9 10 while(counter <=200){ 11 counter ++; 12 if(counter %2){ 13 continue ; 14 } 15 16 Sensor_0 ++; 17 } 18 Backlight(true); 19 </pre>
<p>• Logical Operators</p>		
<p>&&</p>	<p><Term 1>&&<Term 2></p>	<p>Provides 1 if both <Term 1> and <Term 2> are true and 0 otherwise.</p> <p>[Example]</p> <p>Named variable</p> <pre> 9 int a=0,b=10,c; 10 11 if((a==0)&&(b==10)){ 12 c=10; 13 } 14 </pre> <p>Direct variable</p> <pre> 8 @[0:W:HW0000] = 10; 9 @[0:W:HW0001] = 0; 10 if@[0:W:HW0000] >0 && @[0:W:HW0001] > 0) 11 @[0:W:HW0002] = 10; 12 else 13 @[0:W:HW0002] = 20; 14 </pre> <p>Temporary variable</p> <pre> 9 int a=0,b=10,c; 10 \$S=15; 11 c=1; 12 if((a==0)&&(\$S==15)){ 13 c=10; 14 } </pre>
<p> </p>	<p><Term 1> <Term 2></p>	<p>Provides 1 if both <Term 1> and <Term 2> are false and 0 otherwise.</p> <p>[Example]</p> <p>Named variable</p> <pre> 9 int a=0,b=10,c; 10 11 if((a!=0) (b!=10)){ 12 c=1; 13 } 14 else 15 { 16 c=10; 17 } 18 </pre> <p>Direct variable</p>

Command	Expression	Description
		<pre> 9 int c; 10 @[0:w:%mw40]=15; 11 @[0:w:%mw30] = 5; 12 13 if(@[0:w:%mw30]!=0) (@[0:w:%mw40]!=15)){ 14 c=10; 15 } 16 else 17 { 18 c=1; 19 } </pre> <p>Temporary variable</p> <pre> 9 int a=5,b=10,c; 10 \$S=15; 11 12 if((a!=0) (\$S!=15)){ 13 c=10; 14 } 15 else 16 { 17 c=1; 18 } </pre>
!	! <Term>	<p>Provides 1 if <Term> is 0 and otherwise 0. [Example] Named variable</p> <pre> 9 int a=0,b=10,c; 10 11 if((a!=0) (b!=10)){ 12 c=1; 13 } 14 else 15 { 16 c=10; 17 } </pre> <p>Direct variable</p> <pre> 9 int c; 10 @[0:w:%mw40] = 15; 11 @[0:w:%mw30]=0; 12 if(@[0:w:%mw30]!=0){ 13 c=1; 14 } 15 if(@[0:w:%mw40]!=15) 16 { 17 c=1; 18 } 19 if(@[0:w:%mw40]!=14) 20 { 21 c=10; 22 } </pre> <p>Temporary variable</p>

Command	Expression	Description
		<pre> 9 int a=0,b=10,c; 10 \$S = 15; 11 12 if(a!=0){ 13 c=1; 14 } 15 if(\$S!=15) 16 { 17 c=1; 18 } 19 if(\$S!=14) 20 { 21 c=10; 22 } </pre>
<p>• Relational Operators</p>		
<	<Term 1><<Term 2>	<p>Provides 1 if <Term 1> is smaller than <Term 2> and otherwise 0.</p> <p>[Example]</p> <p>Named variable</p> <pre> 9 int a=0,b=10,c; 10 11 if(a<1){ 12 if(b<11) 13 c=10; 14 else 15 c=1; 16 } 17 else 18 c=1; 19 </pre> <p>Direct variable</p> <pre> 9 int c; 10 @[0:w:%mw40] = 15; 11 @[0:w:%mw30]=0; 12 if(@[0:w:%mw30]<1){ 13 if(@[0:w:%mw40]<16) 14 c=10; 15 else 16 c=15; 17 } 18 else 19 c=1; </pre> <p>Temporary variable</p> <pre> 9 int a=0,b=10,c; 10 \$S = 15; 11 if(a<1){ 12 if(\$S<16) 13 c=10; 14 else 15 c=15; 16 } 17 else 18 c=1; </pre>
<=	<Term 1><= <Term 2>	<p>Provides 1 if <Term 1> is smaller than or equal to <Term 2> and otherwise 0.</p> <p>[Example]</p> <p>Named variable</p>

Command	Expression	Description
		<pre> 9 int a=0,b=10,c; 10 11 if(a<=0){ 12 if(b<=10) 13 c=10; 14 else 15 c=1; 16 } 17 else 18 c=1; 19 </pre> <p>Direct variable</p> <pre> 8 int c; 9 10 @[0:w:%mw40] = 15; 11 @[0:w:%mw30]=0; 12 if(@[0:w:%mw30]<=0){ 13 if(@[0:w:%mw40]<=15) 14 c=10; 15 else 16 c=1; 17 } 18 else 19 c=1; 20 </pre> <p>Temporary variable</p> <pre> 9 int a=0,b=10,c; 10 11 \$S = 15; 12 if(a<=0){ 13 if(\$S<=15) 14 c=10; 15 else 16 c=1; 17 } 18 else 19 c=1; 20 </pre>
>	<Term 1>><Term 2>	<p>Provides 1 if <Term 1> is larger than <Term 2> and otherwise 0.</p> <p>[Example]</p> <p>Named variable</p> <pre> 9 int a=0,b=10,c; 10 11 if(a>-1){ 12 if(b>9) 13 c=10; 14 else 15 c=1; 16 } 17 else 18 c=1; 19 </pre> <p>Direct variable</p>

Command	Expression	Description
		<pre> 9 int c; 10 11 @ [0:w:%mw40]=15; 12 @ [0:w:%mw30]=0; 13 if (@ [0:w:%mw30] > -1) { 14 if (@ [0:w:%mw40] > 14) 15 c=10; 16 else 17 c=1; 18 } 19 else 20 c=1; </pre> <p>Temporary variable</p> <pre> 9 int a=0,b=10,c; 10 11 \$S=15; 12 if (a > -1) { 13 if (\$S > 14) 14 c=10; 15 else 16 c=1; 17 } 18 else 19 c=1; </pre>
<p>>=</p>	<p><Term 1> >= <Term 2></p>	<p>Provides 1 if <Term 1> is larger than or equal to <Term 2> and otherwise 0.</p> <p>[Example]</p> <p>Named variable</p> <pre> 10 int a=0,b=10,c; 11 12 if (a >= 0) { 13 if (b >= 10) 14 c=10; 15 else 16 c=1; 17 } 18 else 19 c=1; </pre> <p>Direct variable</p> <pre> 10 int c; 11 @ [0:w:%mw40] = 15; 12 @ [0:w:%mw30]=0; 13 if (@ [0:w:%mw30] >= 0) { 14 if (@ [0:w:%mw40] >= 15) 15 c=10; 16 else 17 c=1; 18 } 19 else 20 c=1; </pre> <p>Temporary variable</p> <pre> 10 int a=0,b=10,c; 11 \$S = 15; 12 if (a >= 0) { 13 if (\$S >= 15) 14 c=10; 15 else 16 c=1; 17 } 18 else 19 c=1; </pre>

Command	Expression	Description
!=	<Term 1> != <Term 2>	<p>Provides 1 if <Term 1> is not equal to <Term 2> and otherwise 0.</p> <p>[Example]</p> <p>Named variable</p> <pre> 9 int a=0,b=10,c; 10 11 if(a!=0) 12 c=1; 13 else if(b!=10) 14 c=1; 15 else 16 c=10; </pre> <p>Direct variable</p> <pre> 9 int c; 10 11 @ [0:w:%mw40] = 15; 12 @ [0:w:%mw30]=0; 13 if(@ [0:w:%mw30]!=0) 14 c=1; 15 else if(@ [0:w:%mw40]!=15) 16 c=1; 17 else 18 c=10; </pre> <p>Temporary variable</p> <pre> 9 int a=0,b=10,c; 10 11 \$S = 15; 12 if(a!=0) 13 c=1; 14 else if(\$S!=15) 15 c=1; 16 else 17 c=10; </pre>
==	<Term 1> == <Term 2>	<p>Provides 1 if <Term 1> is equal to <Term 2> and otherwise 0.</p> <p>[Example]</p> <p>Named variable</p> <pre> 9 int a=0,b=10,c; 10 11 if(a==0) 12 { 13 if(b==10) 14 c=10; 15 else 16 c=1; 17 } 18 else 19 c=1; </pre> <p>Direct variable</p>

Command	Expression	Description
		<pre> 9 int c; 10 @[0:w:%mw40] = 15; 11 @[0:w:%mw30]=0; 12 if(@[0:w:%mw30]==0) 13 { 14 if(@[0:w:%mw40]==15) 15 c=10; 16 else 17 c=1; 18 } 19 else 20 c=1; </pre> <p>Temporary variable</p> <pre> 9 int a=0,b=10,c; 10 \$S = 15; 11 if(a==0) 12 { 13 if(\$S==15) 14 c=10; 15 else 16 c=1; 17 } 18 else 19 c=1; </pre>

• **Mathematical Operators**

+	<Term> + <factor>	<p>Adds <Term> to <factor>.</p> <p>[Example]</p> <p>Named variable</p> <pre> 10 int a=0,b=10,c; 11 12 c = a+b; 13 if(c==10) 14 c=10; 15 else 16 c=1; </pre> <p>Direct variable</p> <pre> 10 int c; 11 12 @[0:w:%mw40]=15; 13 @[0:w:%mw30]=0; 14 c = @[0:w:%mw30]+@[0:w:%mw40]; 15 if(c==15) 16 c=10; 17 else 18 c=1; </pre> <p>Temporary variable</p> <pre> 10 int a=0,b=10,c; 11 12 \$S=15; 13 c = a+\$S; 14 if(c==15) 15 c=10; 16 else 17 c=1; </pre>
-	<Term> - <factor>	<p>Subtracts <factor> from <Term>.</p> <p>[Example]</p>

Command	Expression	Description
		<p>Named variable</p> <pre> 10 int a=0,b=10,c; 11 12 c = a-b; 13 if(c==(-10)) 14 c=10; 15 else 16 c=1; </pre> <p>Direct variable</p> <pre> 10 int c; 11 @[0:w:%mw40]=15; 12 @[0:w:%mw30]=0; 13 c = @[0:w:%mw30]-@[0:w:%mw40]; 14 if(c==(-15)) 15 c=10; 16 else 17 c=1; </pre> <p>Temporary variable</p> <pre> 10 int a=0,b=10,c; 11 \$S=15; 12 c = a-\$S; 13 if(c==(-15)) 14 c=10; 15 else 16 c=1; </pre>
*	<Term> * <factor>	<p>Multiplies <Term> by <factor>.</p> <p>[Example]</p> <p>Named variable</p> <pre> 9 int a=0,b=10,c; 10 11 c = a*b; 12 if(c==0) 13 c=10; 14 else 15 c=1; </pre> <p>Direct variable</p> <pre> 9 int c; 10 @[0:w:%mw40]=15; 11 @[0:w:%mw30]=2; 12 c = @[0:w:%mw30]*@[0:w:%mw40]; 13 if(c==30) 14 c=10; 15 else 16 c=1; </pre> <p>Temporary variable</p> <pre> 9 int a=2,b=10,c; 10 \$S=15; 11 c = a*\$S; 12 if(c==30) 13 c=10; 14 else 15 c=1; </pre>
/	<Term> / <factor>	<p>Divides <Term> by <factor>.</p> <p>[Example]</p> <p>Named variable</p>

Command	Expression	Description
		<pre> 10 int a=20,b=10,c; 11 12 c = a/b; 13 if(c==2) 14 c=10; 15 else 16 c=1; </pre> <p>Direct variable</p> <pre> 10 int c; 11 @[0:w:%mw40]=15; 12 @[0:w:%mw30]=30; 13 c = @[0:w:%mw30]/@[0:w:%mw40]; 14 if(c==2) 15 c=10; 16 else 17 c=1; </pre> <p>Temporary variable</p> <pre> 10 int a=30,b=10,c; 11 \$S=15; 12 c = a/\$S; 13 if(c==2) 14 c=10; 15 else 16 c=1; </pre>
%	<Term> % <factor>	<p>Divides <Term> by <factor> and takes the residual. [Example]</p> <p>Named variable</p> <pre> 10 int a=20,b=10,c; 11 12 c = a%b; 13 if(c==0) 14 c=10; 15 else 16 c=1; </pre> <p>Direct variable</p> <pre> 10 int c; 11 @[0:w:%mw40]=15; 12 @[0:w:%mw30]=30; 13 c = @[0:w:%mw30]%@[0:w:%mw40]; 14 if(c==0) 15 c=10; 16 else 17 c=1; </pre> <p>Temporary variable</p> <pre> 10 int a=30,b=10,c; 11 \$S=15; 12 c = a%\$S; 13 if(c==0) 14 c=10; 15 else 16 c=1; </pre>
<p>• Bit Operators</p>		
&	<Term>&<factor>	Performs the bit operation (AND) of <Term> and

Command	Expression	Description
		<p><factor>.</p> <p>[Example]</p> <p>Named variable</p> <pre> 9 int c; 10 int a,b,d; 11 a=2; 12 b=3; 13 d = a&b; 14 if(d==2) 15 c=10; 16 else 17 c=1; </pre> <p>Direct variable</p> <pre> 9 int c; 10 11 @[0:w:%mw40]=3; 12 @[0:w:%mw30]=2; 13 14 @[0:w:%mw20] = @[0:w:%mw30] & @[0:w:%mw40]; 15 if(@[0:w:%mw20]==2) 16 c=10; 17 else 18 c=1; </pre> <p>Temporary variable</p> <pre> 9 int c; 10 int a,b,d; 11 a=2; 12 \$S=3; 13 14 d = a & \$S; 15 if(d==2) 16 c=10; 17 else 18 c=1; </pre>
	<Term> <factor>	<p>Performs the bit operation (OR) of <Term> or <factor>.</p> <p>[Example]</p> <p>Named variable</p> <pre> 9 int c; 10 int a,b,d; 11 a=2; 12 b=3; 13 14 d = a b; 15 if(d==3) 16 c=10; 17 else 18 c=1; </pre> <p>Direct variable</p>

Command	Expression	Description
		<pre> 9 int c; 10 11 @[0:w:%mw40]=3; 12 @[0:w:%mw30]=2; 13 14 @[0:w:%mw20] = @[0:w:%mw30] @[0:w:%mw40]; 15 if(@[0:w:%mw20]==3) 16 c=10; 17 else 18 c=1; Temporary variable 9 int c; 10 int a,b,d; 11 a=2; 12 \$S=3; 13 14 d = a \$S; 15 if(d==3) 16 c=10; 17 else 18 c=1; </pre>
~	~ <bit>	<p>Reverses the <bit> value.</p> <p>[Example]</p> <p>Named variable</p> <pre> 9 int c; 10 int b,d; 11 b=0; 12 13 d = ~b; 14 if(d==(-1)) 15 c=10; 16 else 17 c=1; </pre> <p>Direct variable</p> <pre> 8 int c; 9 10 @[0:w:%mw40]=0; 11 12 13 14 @[0:w:%mw30] = ~@[0:w:%mw40]; 15 16 if(@[0:w:%mw30]==(-1)) 17 c=10; 18 else 19 c=1; </pre> <p>Temporary variable</p>

Command	Expression	Description
		<pre> 8 int c; 9 10 @[0:w:%mw40]=0; 11 12 13 14 @[0:w:%mw30] = ~@[0:w:%mw40]; 15 16 if(@[0:w:%mw30]==(-1)) 17 c=10; 18 else 19 c=1; </pre>
^	<Term> ^ <factor>	<p>Performs the bit operation (EOR) of <Term> or <factor>.</p> <p>[Example]</p> <p>Named variable</p> <pre> 9 int c; 10 int a,b,d; 11 a=2; 12 b=3; 13 14 d = a^b; 15 if(d==1) 16 c=10; 17 else 18 c=1; </pre> <p>Direct variable</p> <pre> 9 int c; 10 11 @[0:w:%mw40]=3; 12 @[0:w:%mw30]=2; 13 14 @[0:w:%mw20] = @[0:w:%mw30]^@[0:w:%mw40]; 15 if(@[0:w:%mw20]==1) 16 c=10; 17 else 18 c=1; </pre> <p>Temporary variable</p> <pre> 9 int c; 10 int a,b,d; 11 a=2; 12 \$S=3; 13 14 d = a^\$S; 15 if(d==1) 16 c=10; 17 else 18 c=1; </pre>
<<	<Term><<<factor>	<p>Shifts <Term> to the left by the value of <factor>.</p> <p>[Example]</p> <p>Named variable</p>

Command	Expression	Description
		<pre> 8 int c; 9 int a=4,b=2,d; 10 11 d = a<<b; 12 if(d==16) 13 c=10; 14 else 15 c=1; Direct variable 8 int c; 9 10 11 @[0:w:%mw40] = 2; 12 @[0:w:%mw30]=4; 13 @[0:w:%mw20] = @[0:w:%mw30]<<@[0:w:%mw40]; 14 if(@[0:w:%mw20]==16) 15 c=10; 16 else 17 c=1; Temporary variable 8 int c; 9 int a=4,d; 10 11 \$S = 2; 12 d = a<<\$S; 13 if(d==16) 14 c=10; 15 else 16 c=1; </pre>
>>	<Term>>><factor>	<p>Shifts <Term> to the right by the value of <factor>.</p> <p>[Example]</p> <p>Named variable</p> <pre> 9 int c; 10 int a=16,b=2,d; 11 12 d = a>>b; 13 if(d==4) 14 c=10; 15 else 16 c=1; </pre> <p>Direct variable</p> <pre> 9 int c; 10 11 @[0:w:%mw40]=2; 12 @[0:w:%mw30]=16; 13 @[0:w:%mw20] = @[0:w:%mw30]>>@[0:w:%mw40]; 14 if(@[0:w:%mw20]==4) 15 c=10; 16 else 17 c=1; </pre> <p>Temporary variable</p>

Command	Expression	Description
		<pre> 9 int c; 10 int a=16,d; 11 \$S=2; 12 13 d = a>>\$S; 14 if(d==4) 15 c=10; 16 else 17 c=1; </pre>
• Assignment Operators		
=	<Device> = <term>	<p>Assigns the value of <term> to <Device>.</p> <p>[Example]</p> <p>Named variable</p> <pre> 9 int c; 10 int a=16,b=2,d; 11 12 d = a; 13 if(d==16) 14 c=10; 15 else 16 c=1; </pre> <p>Direct variable</p> <pre> 9 int c; 10 11 @[0:w:%mw40]=16; 12 13 @[0:w:%mw30] = @[0:w:%mw40]; 14 if(@[0:w:%mw30]==16) 15 c=10; 16 else 17 c=1; </pre> <p>Temporary variable</p> <pre> 9 int c; 10 int d; 11 12 \$S=16; 13 14 d = \$S; 15 if(d==16) 16 c=10; 17 else 18 c=1; </pre>
+=	<Device> += <term>	<p>Adds <term> to <Device> and assigns the value of the result of the operation to <Device>.</p> <p>[Example]</p> <p>Named variable</p> <pre> 9 int c; 10 int a=16,b=2,d=4; 11 12 d += a; 13 if(d==20) 14 c=10; 15 else 16 c=1; </pre>

Command	Expression	Description
		<p>Direct variable</p> <pre> 8 int c; 9 10 11 @[0:w:%mw40]=16; 12 @[0:w:%mw30]=4; 13 @[0:w:%mw30] += @[0:w:%mw40]; 14 if(@[0:w:%mw30]==20) 15 c=10; 16 else 17 c=1; </pre> <p>Temporary variable</p> <pre> 9 int c; 10 int d=4; 11 12 \$S=16; 13 d += \$S; 14 if(d==20) 15 c=10; 16 else 17 c=1; </pre>
<p>-=</p>	<p><Device> -= <term></p>	<p>Subtracts <term> from <Device> and assigns the value of the result of the operation to <Device>.</p> <p>[Example]</p> <p>Named variable</p> <pre> 10 int c; 11 int a=16,b=2,d=4; 12 13 d -= a; 14 if(d==(-12)) 15 c=10; 16 else 17 c=1; </pre> <p>Direct variable</p> <pre> 10 int c; 11 12 @[0:w:%mw30]=4; 13 @[0:w:%mw40]=16; 14 15 @[0:w:%mw30] -= @[0:w:%mw40]; 16 if(@[0:w:%mw30]==(-12)) 17 c=10; 18 else 19 c=1; </pre> <p>Temporary variable</p> <pre> 10 int c; 11 int d=4; 12 13 \$S=16; 14 15 d -= \$S; 16 if(d==(-12)) 17 c=10; 18 else 19 c=1; </pre>

Command	Expression	Description
<code>*=</code>	<code><Device> *= <term></code>	<p>Multiplies <code><Device></code> by <code><term></code> and assigns the value of the result of the operation to <code><Device></code>.</p> <p>[Example]</p> <p>Named variable</p> <pre> 10 int c; 11 int a=16,b=2,d=4; 12 13 d *= a; 14 if(d==64) 15 c=10; 16 else 17 c=1; </pre> <p>Direct variable</p> <pre> 10 int c; 11 12 @[0:w:%mw40]=16; 13 @[0:w:%mw30]=4; 14 @[0:w:%mw30] *= @[0:w:%mw40]; 15 if(@[0:w:%mw30]==64) 16 c=10; 17 else 18 c=1; </pre> <p>Temporary variable</p> <pre> 10 int c; 11 int d=4; 12 \$S=16; 13 d *= \$S; 14 if(d==64) 15 c=10; 16 else 17 c=1; </pre>
<code>/=</code>	<code><Device> /= <term></code>	<p>Divides <code><Device></code> by <code><term></code> and assigns the value of the result of the operation to <code><Device></code>.</p> <p>[Example]</p> <p>Named variable</p> <pre> 9 int c; 10 int a=4,b=2,d=16; 11 12 d /= a; 13 if(d==4) 14 c=10; 15 else 16 c=1; </pre> <p>Direct variable</p> <pre> 9 int c; 10 11 @[0:w:%mw40]=4; 12 @[0:w:%mw30]=16; 13 14 @[0:w:%mw0] /= @[0:w:%mw40]; 15 if(@[0:w:%mw30]==4) 16 c=10; 17 else 18 c=1; </pre> <p>Temporary variable</p>

Command	Expression	Description
		<pre> 9 int c; 10 int d=16; 11 \$S=4; 12 13 d /= \$S; 14 if(d==4) 15 c=10; 16 else 17 c=1; </pre>
%=	<Device> %= <term>	<p>Divides <Device> by <term> and takes the residue and then assigns the value of the result of the operation to <Device>.</p> <p>[Example]</p> <p>Named variable</p> <pre> 10 int c; 11 int a=5,b=2,d=16; 12 13 d %= a; 14 if(d==1) 15 c=10; 16 else 17 c=1; </pre> <p>Direct variable</p> <pre> 10 int c; 11 12 @ [0:w:%mw40]=5; 13 @ [0:w:%mw30]=16; 14 @ [0:w:%mw30] %= @ [0:w:%mw40]; 15 if(@ [0:w:%mw30]==1) 16 c=10; 17 else 18 c=1; </pre> <p>Temporary variable</p> <pre> 10 int c; 11 int d=16; 12 \$S=5; 13 14 d %= \$S; 15 if(d==1) 16 c=10; 17 else 18 c=1; </pre>
=	<Device> = <term>	<p>Performs the bit operation (AND) of <term> to <Device> and assigns the value of the result of the operation to <Device>.</p> <p>[Example]</p> <p>Named variable</p>

Command	Expression	Description
		<pre> 9 int c; 10 int d,b; 11 d=0; 12 b=2; 13 14 15 d = b; 16 if(d==2) 17 c=10; 18 else 19 c=1; </pre> <p>Direct variable</p> <pre> 9 int c; 10 @[0:w:%mw40]=2; 11 @[0:w:%mw30]=0; 12 13 @[0:w:%mw30] = @[0:w:%mw40]; 14 if(@[0:w:%mw30]==2) 15 c=10; 16 else 17 c=1; </pre>
&=	<Device>&= <term>	<p>Performs the bit operation (OR) of <term> to <Device> and assigns the value of the result of the operation to <Device>.</p> <p>[Example]</p> <p>Direct variable</p> <pre> 9 int c; 10 @[0:w:%mw40]=3; 11 @[0:w:%mw30]=1; 12 13 @[0:w:%mw30] &= @[0:w:%mw40]; 14 if(@[S:HW0030]==1) 15 c=10; 16 else 17 c=1; 18 </pre>
^=	<Device> ^= <term>	<p>Performs the bit operation (EOR) of <term> to <Device> and assigns the value of the result of the operation to <Device>.</p> <p>[Example]</p> <p>Named variable</p> <pre> 10 int c; 11 int d,b; 12 d=1; 13 b=2; 14 15 d ^= b; 16 if(d==3) 17 c=10; 18 else 19 c=1; </pre> <p>Direct variable</p>

Command	Expression	Description
		<pre> 10 int c; 11 12 @[0:w:%mw30]=1; 13 @[0:w:%mw40]=3; 14 15 @[0:w:%mw30] ^= @[0:w:%mw40]; 16 if(@[0:w:%mw30]==2) 17 c=10; 18 else 19 { 20 c=1; 21 } </pre> <p>Temporary variable</p> <pre> 10 int c; 11 int d,b; 12 d=1; 13 \$S=3; 14 15 16 d ^= \$S; 17 if(d==2) 18 c=10; 19 else 20 { 21 c=1; 22 } </pre>
<<=	<Device><<= <term>	<p>Shifts <Device> to the left by <term> and assigns the value of the result of the operation to <Device>.</p> <p>[Example]</p> <p>Named variable</p> <pre> 8 int c; 9 int a=4,b=2,d=4; 10 11 d <<=b; 12 if(d==16) 13 c=10; 14 else 15 c=1; </pre> <p>Direct variable</p> <pre> 8 int c; 9 10 @[0:w:%mw30]=4; 11 @[0:w:%mw40]=2; 12 @[0:w:%mw30] <<=@[0:w:%mw40]; 13 if(@[0:w:%mw30]==16) 14 c=10; 15 else 16 c=1; </pre> <p>Temporary variable</p> <pre> 8 int c; 9 int d=4; 10 11 \$S=2; 12 13 d <<=\$S; 14 if(d==16) 15 c=10; 16 else 17 c=1; </pre>

Command	Expression	Description
>>=	<Device>>>= <term>	<p>Shifts <Device> to the right by <term> and assigns the value of the result of the operation to <Device>.</p> <p>[Example]</p> <p>Named variable</p> <pre> 9 int c; 10 int a=4,b=2,d=128; 11 12 d >>=b; 13 if(d==32) 14 c=10; 15 else 16 c=1; </pre> <p>Direct variable</p> <pre> 9 int c; 10 @[0:w:%mw30]=128; 11 @[0:w:%mw40]=2; 12 @[0:w:%mw30] >>=@[0:w:%mw40]; 13 if(@[S:HW0030]==32) 14 c=10; 15 else 16 c=1; </pre> <p>Temporary variable</p> <pre> 9 int c; 10 int d=128; 11 12 \$S=2; 13 14 d >>=\$S; 15 if(d==32) 16 c=10; 17 else 18 c=1; </pre>
<p>• Increment/Decrement Operators</p>		
++	++<Device>; <Device>++;	<p>Increases <Device> by 1.</p> <p>[Example]</p> <pre> 6 // Increment operator 7 8 int a, b, c, d, e, f; 9 10 a = b* ++c; // Prefix : 11 // C increases before it is used. 12 13 d = b* f++; // Postfix: 14 // F increases after it is used. 15 </pre>
--	--<Device>; <Device>--;	<p>Decreases <Device> by 1.</p> <p>[Example]</p> <pre> 6 // Decrement operator 7 8 int a, b, c, d, e, f; 9 10 a = b* --c; // Prefix : 11 // C decreases before it is used. 12 13 d = b* f--; // Postfix: 14 // F decreases after it is used. </pre>

4.2.1.2 Understanding Device Address Expressions

To express a device address in a script, use this format: @[Device type: Connection number: Station address: Tag name or Device address], with the data inside the brackets describing the physical address of the device in the PLC. Examples of device address formats are shown in the table below:

Note

- In the sample expressions that follow, “1” refers to the direct device address, which varies by PLC type. For more information, refer to **<4.2.1.3 Understanding Constants and Data Types>**.
- Connection numbers range from 0 to 3.

Device	Device Address Format	Device Address Examples
Bit (Device type=X)	@[X: Address] @[X: Conn#: Address] @[X: Stn#: Address] @[X: Conn#: Stn#: Address]	@[X: %MX1] @[X: 0: %MX1] @[X: #1: %MX1] @[X: 0: #1: %MX1]
Short (Device type=S)	@[S: Address] @[S: Conn#: Address] @[S: Stn#: Address] @[S: Conn#: Stn#: Address]	@[S: %MW000] @[S: 0: %MW000] @[S: #1: %MW000] @[S: 2: #1: %MW000]
Integer (Device type=L)	@[L: Address] @[L: Conn#: Address] @[L: Stn#: Address] @[L: Conn#: Stn#: Address]	@[L: %MW000] @[L: 0: %MW000] @[L: #1: %MW000] @[L: 2: #1: %MW000]
Unsigned Short (Device type=W)	@[W: Address] @[W: Conn#: Address] @[W: Stn#: Address] @[W: Conn#: Stn#: Address]	@[W: %MW000] @[W: 0: %MW000] @[W: #1: %MW000] @[W: 2: #1: %MW000]
Unsigned Integer (Device type=D)	@[D: Address] @[D: Conn#: Address] @[D: Stn#: Address] @[D: Conn#: Stn#: Address]	@[D: %MW000] @[D: 0: %MW000] @[D: #1: %MW000] @[D: 2: #1: %MW000]
Float (Device type=F)	@[F: Address] @[F: Conn#: Address] @[F: Stn#: Address] @[F: Conn#: Stn#: Address]	@[F: %MW000] @[F: 0: %MW000] @[F: #1: %MW000] @[F: 2: #1: %MW000]

4.2.1.3 Understanding Constants and Data Types

Scripts employ a systematic expression of data. The table below describes the constants used by scripts in XP-Builder.

Constant	Examples
Decimal Numbers	124, -34, 0, 2334454
Real Numbers	0.123, 10.45E12, 0.0
Hexadecimal Numbers	0x45FA, 0xffff
Binary Numbers	true, false
Characters	"a", "1", "0", "%"
Strings	"123abc"

Script functions can express and return various data types. The table below describes the data types used by scripts in XP-Builder.

Type	Description	Data range	Example
Boolean (1 bit)	<ul style="list-style-type: none"> Expresses either "true or false" The abbreviation "bool" comes first, followed by the variable name. Initializes as "true" or "false" <pre> 1 // BooleanType 2 3 bool left , right ; // BooleanType Variable Declaration 4 5 // BooleanType Variable 6 7 bool sensor_1 = true, sensor_2 = false Initialization 8 9 10 11 </pre>	0 to 1	bool bState = true;
Character (8 bit)	<ul style="list-style-type: none"> Expresses a character To initialize a variable, place "=" after the variable name and specify a value. 	-127 to 127	char cValue = -10 ;
Short (16 bit)	<ul style="list-style-type: none"> This data type uses less memory than an integer. To initialize a variable, place "=" after the variable name and specify a value. 	-32768 to 32767	short nValue = -10 ;

Type	Description	Data range	Example
	<pre> 6 // Short Type 7 8 short nIndex ; // Single Variable Declaration 9 short , nvalue , total ; // Multiple Variables 10 // Declaration 11 12 short nIndex = 10 ; // Variable Initialization 13 short nvalue = 8, total = 6 ; </pre>		
Integer (32 bit)	<ul style="list-style-type: none"> • A signed integer can be a positive number, a negative number, or 0. • To declare multiple variables, place “int” first, followed by the variables separated by commas. • To initialize a variable, place “=” after the variable name and specify a value. 	-2147483648 to 2147483647	int nValue = -100 ;
	<pre> 6 // Integer Type 7 8 int score ; // Single Variable Declaration 9 int sensor, num, erns ; // Multiple Variables Declaration 10 11 12 int score = -30 ; // Variable Initialization 13 int sensor = -12, num = 13, erns = 19 ; // Multiple Variables // Initialization </pre>		
Unsigned Short (16 bit)	To initialize a variable, place “=” after the variable name and specify a value.	0 to 65535	unsigned short nValue = 10 ;
	<pre> 6 // Unsigned Short Type 7 8 unsigned short score ; // Single Variable Declaration 9 unsigned short sensor, num, erns // Multiple Variables Declaration 10 11 12 unsigned short score = 30 ; // Variable Initialization 13 unsigned short sensor = 12, num = 13, erns = 19 // Multiple Variables // Initialization </pre>		
Unsigned Integer (32 bit)	<ul style="list-style-type: none"> • This data type is used for a positive number including 0. • To initialize a variable, place “=” after the variable name and specify a value. 	0 to 4294967295	unsigned int nValue = 100 ;

Type	Description	Data range	Example
	<pre> 6 // Unsigned Integer Type 7 8 unsigned int score ; // Single Variable Declaration 9 unsigned int sensor, num, erns ; // Multiple Variables Declaration 10 11 12 unsigned int score = 30 ; // Variable Initialization 13 unsigned int sensor = 12, num = 13, erns = 19 ; // Multiple Variables // Initialization </pre>		
Float (32 bit)	To initialize a variable, place “=” after the variable name and specify a value.	1.175494351 E – 38 to 3.402823466 E + 38	float fValue = 10.01 ;
	<pre> 5 const float fcVal = 100.123; 6 float fVal1 = 100.4; 7 float fVal2 = 100.45; 8 float fVal3; </pre>		

Note

A bit is the basic unit of computer memory. It is represented as either a 0 or 1. The two values can also be interpreted as activation states (On/Off).

You can declare an array variable the same way as other variables. When initializing variables after an array declaration, the variables should be placed in brace brackets. You can also place a string in quotation marks for the character type. If you do not initialize an array variable, the variable may have a value other than 0. It is advised to initialize an array variable before use.

The table below shows examples of the data types used by scripts in XP-Builder.

Type	Example	Initialization Examples
Boolean	bool bState[3];	bool bState[3] = {true, false, true} bool bState[3] = {1, 0, 1};
Short	short nValue[3];	short nValue[3] = {1, 2, 3};
Character	char cValue[3];	char cValue[3] = {'a', 'b', 'c'}; or char cValue[5] = "1234"
Integer	int nValue[4];	int nValue[4] = {-100, -200, 100, 200};
Unsigned Short	unsigned short nValue[3];	unsigned short nValue[3] = {0, 100, 200};
Unsigned Integer	unsigned int nValue[5];	unsigned int nValue[5] = {10, 11, 12, 13, 15};
Float	float fValue[2];	float fValue[2] = {10.0, 20.0}; or float fValue[2] = {1.175494351e-38 , -1.175494351e-38};

Note

- If you initialize a larger number than the number of the declared array, an error will occur:
int nValue[3] = {1, 2, 3, 4};
- If you initialize a smaller number than the number of the declared array, some variables will not be initialized:
In case of bool bValue[2] = {true}; , bValue[0] is true but bValue[1] may be either true or false.
- When you initialize an array variable of the character type with quotation marks, you can initialize one smaller number than the number of the declared array. That is because a string variable should have a null value at the end to be used for a string:
char cValue[5] = "1234";
- When you initialize an array variable of the character type with quotation marks, you can initialize it with Latin characters, numbers, or special characters. You cannot use Korean characters or other languages.

4.2.1.4 Understanding Temporary Variables in a Script

Standard variables are used as temporary variables. Temporary variables may be defined and used for script operation in objects.

While an operation with a direct (physical) address is reflected and written to the PLC's memory as soon as the operation is run, changes made to the temporary variables are written to the PLC's memory only after the script is completely run.

Only objects with the Input function can write temporary variable values to a direct address (PLC memory).

In the example below, a switch object is assigned with the direct address "%mw10", and the following scripts are run when the switch is pressed. The current value saved at "%mw10" is 100.

- **Script with the direct address "%mw10":**

```
----- Script runs
If (@[w:%mw10] == 100)
{
    @[w:%mw10]= 20; /* true*/
}
Else
{
    @[w:%mw10]= 40;
}
@[w:%mw10] = @[w:%mw10]+1; /*%mw10 = 21 */
----- Script ends
Resulting %mw10 value = 21
```

- **Script with the direct address "%mw10" and a temporary variable \$\$:**

```
----- Script runs
/* $$ is initialized to 100 */
If ($$ == 100)
{
    @[w:%mw10]= 20; /* true*/
}
Else
{
    @[w:%mw10]= 40;
}
}
```

```
$$ = $$+1; /* $$ = 101, @[w:%mw10] = 20 */
```

```
/* $$ value will be written to @[w:%mw10] when the script ends*/
----- Script ends
```

Resulting “%mw10” value = 101

Each data type has a corresponding temporary variable type. The table below shows the standard variable types available.

Variable Type	Example	Value Range
Short	<pre>\$S 8 int c; 9 int d=4; 10 11 \$S=2; 12 13 d <<=\$S; 14 if(d==16) 15 c=10; 16 else 17 c=1;</pre>	-32768 to 32767
Integer	<pre>\$L 9 int c; 10 int a,b,d; 11 a=2; 12 \$L=-3; 13 14 d = a^\$L; 15 if(d==1) 16 c=10; 17 else 18 c=1;</pre>	-2147483648 to 2147483647
Unsigned Short	<pre>\$W 5 int c; 6 int d; 7 8 \$W = 16; 9 10 d = \$W; 11 if(d==16) 12 { 13 c=10; 14 } 15 else 16 { 17 c=1; 18 }</pre>	0 to 65535
Unsigned Integer	<pre>\$D 9 int c; 10 int d; 11 12 \$D=16; 13 14 d = \$D; 15 if(d==16) 16 c=10; 17 else 18 c=1;</pre>	0 to 4294967295

Variable Type	Example	Value Range
Float	<pre> \$F const float fcVal = 100.123; float fVal1 = 100.4; float fVal2 = 100.45; float fVal3; if(fVal1 < fcVal) fVal3 = fVal1 ; else fVal3 = fVal2 ; \$F = fVal3 ; </pre>	-1.175494351e-38, to 3.402823466e+38

4.2.1.5 Viewing the Script Cross Reference

The Script Cross Reference function displays object or common properties used for scripts in the output screen. When a project is executed in the XGT Panel, unexpected script errors may occur. This function allows you to detect script errors without checking individual items that are affected by global or local scripts.

To view the script cross reference, click [Tool] ► [Cross Reference], and then select [Script].

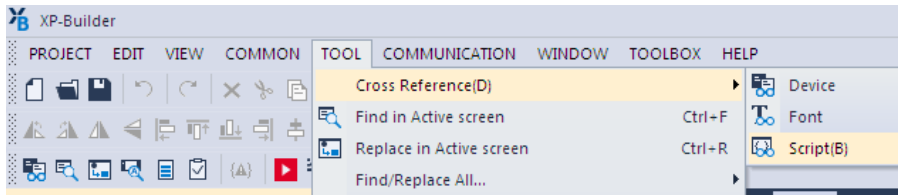

Script names, positions, object types (if they are used), and explanations are displayed in the output pane.

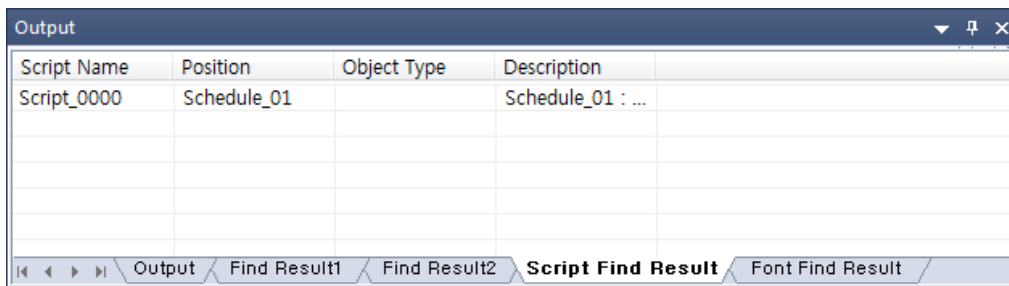

Note

- If you double-click a result in the cross reference, the affected object or screen will open in the editing area.
- If you want to find script information that is applied to objects in the Base screen, click [Tool] ► [Find All Script].

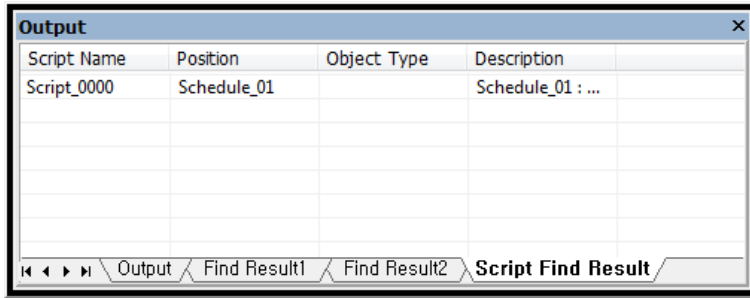

Script Name	Position	Object Type	Description
Script_0000	Schedule_01		Schedule_01 : ...

Navigation: Output Find Result1 Find Result2 **Script Find Result**

4.2.2 Creating Scripts

Learn how to create scripts. You can create scripts from the Project pane, and add functions and variables in the Script Tool box. To apply global settings to scripts, refer to [<2.2.2.8 >](#).

4.2.2.1 Inserting Scripts

To insert a script from the Project pane:

- 1 In the Project pane, double-click [Insert script].
A Script tab will open in the editing area.

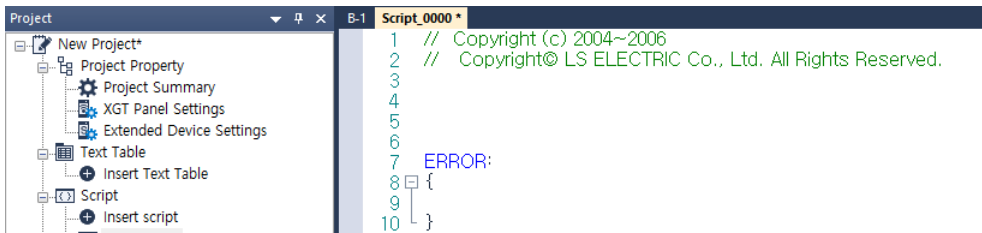

- 2 Create your script in the editing area. Right-click the Script tab and then click [Close] to return to normal screen editing.

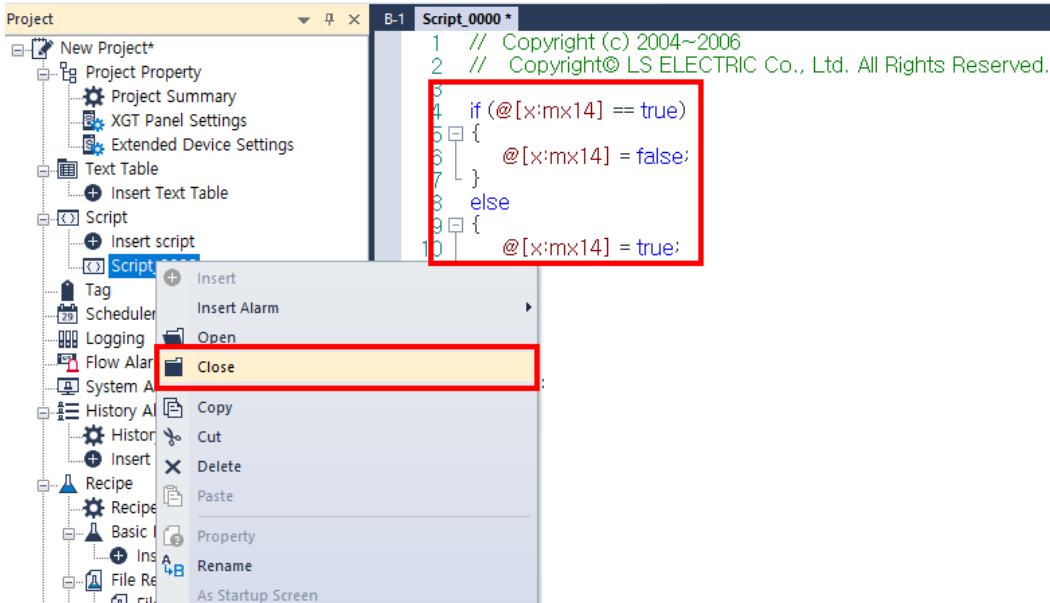

4.2.2.2 Using the Script Tool box

The Script Tool box allows you to create and manage scripts easily. You can select functions and commands from lists instead of entering them manually.

To register the scripts using the Function List:

- 1 Insert a script, as described in <4.2.2.1 Inserting Scripts >.
- 2 Click [View] ► [Script Toolbox].

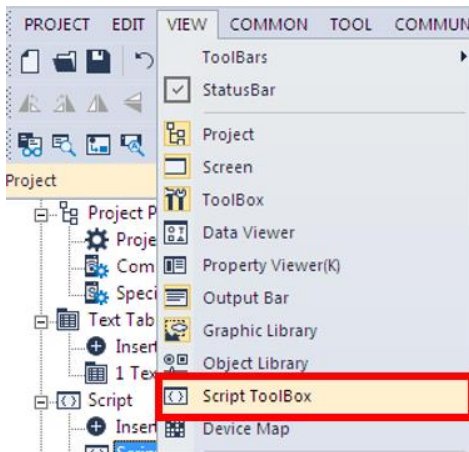

- 3 Click [Function List] to select from lists of pre-defined functions, such as device, screen, and communication operations. Select an operation, set the properties, and then click [Insert], or double-click the operation to insert it into the script.

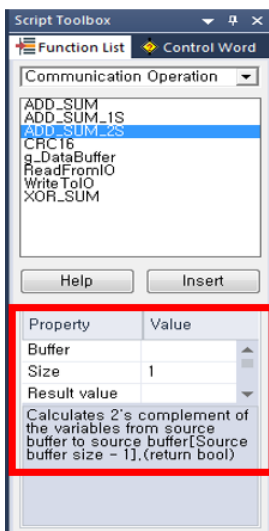

- 4 Check that the selected operation is inserted in the script editing area. You can enter or edit values for the operation directly from the editing area.

```

B-1 스크립트_0000 *
1 // Copyright (c) 2004~2006
2 // Copyright© LS ELECTRIC Co., Ltd. All Rights Reserved.
3
4
5
6
7 ERROR:
8 {
9
10 }
11
12 ADD_SUM_2S( , 1. );
13

```

- 5 In the Script Tool box, click [Control Word] to select from lists of commands, device settings, and operators. Double-click an item to insert it into the script.

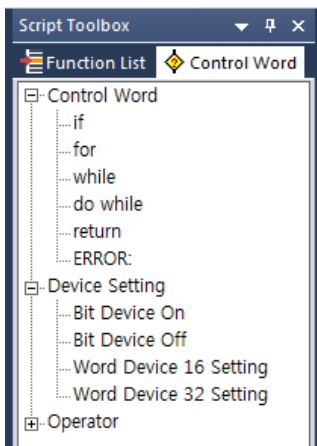

- 6 Check that the selected control word is inserted in the script editing area, and add operands or the rest of the control words as necessary.

4.2.2.3 Specifying Local Scripts

Local scripts run operations on the relevant screen the condition is met. It can only be configured for Base screens.

To configure a local script:

- 1 Create a script, as described in **<4.2.2.1 Inserting Scripts>**.
- 2 Double-click a screen from the Project pane.
- 3 In the editing area, right-click and then click [Screen Property].
- 4 Click [Local Script Setting].

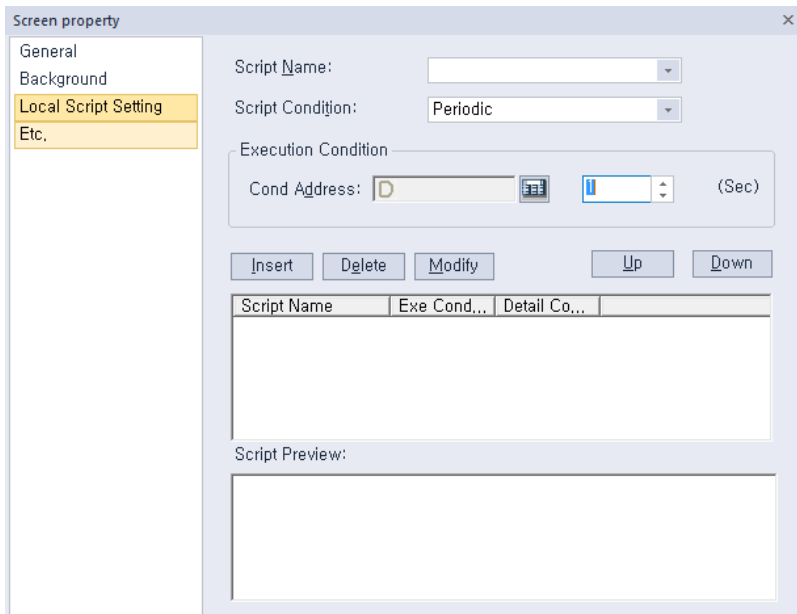

- 5** Select a script and execution condition from the drop-down lists. If you choose an execution condition other than Consecutive or Periodic, specify the device condition address.

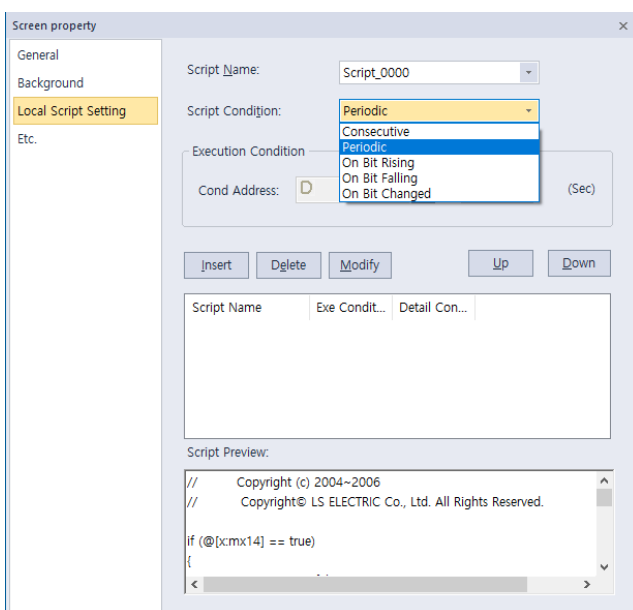

- 6** Click [Insert] and, if necessary, click [Up] or [Down] to prioritize the script.
- 7** Click [OK].

4.2.2.4 Specifying Display Change Scripts

Display scripts are executed when the screen is changed. It can only be configured for Base screens.

To configure a display change script:

- 1 Create a script, as described in <4.2.2.1 Inserting Scripts>.
- 2 Double-click a screen from the Project pane.
- 3 In the editing area, right-click and then click [Screen Property].
- 4 Click [Etc.].

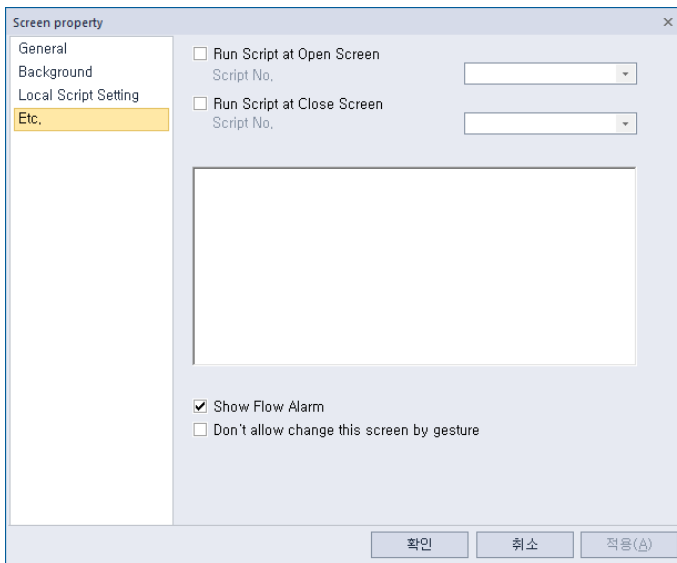

- 5 If desired, check the checkbox next to **Run Script at Open Screen** or **Run Script at Close Screen**, and then select a script to execute, based on the screen status.

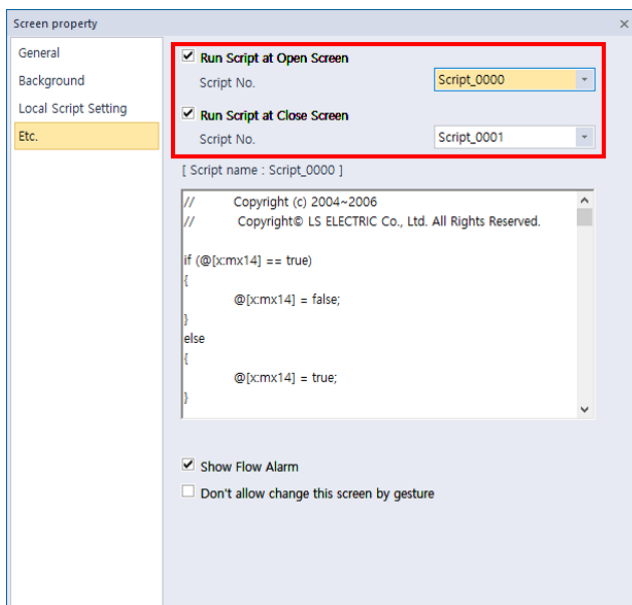

- 6 Click [OK].

4.2.2.5 Specifying Scheduler Scripts

To specify scripts that run on specified schedules:

- 1 Create a script, as described in <4.2.2.1 Inserting Scripts>.
- 2 In the Project pane, double-click [Scheduler].
- 3 In the editing area, double-click a cell in the **Scheduler** tab.
- 4 In the Property window, specify the schedule type, detail condition, and description as desired.

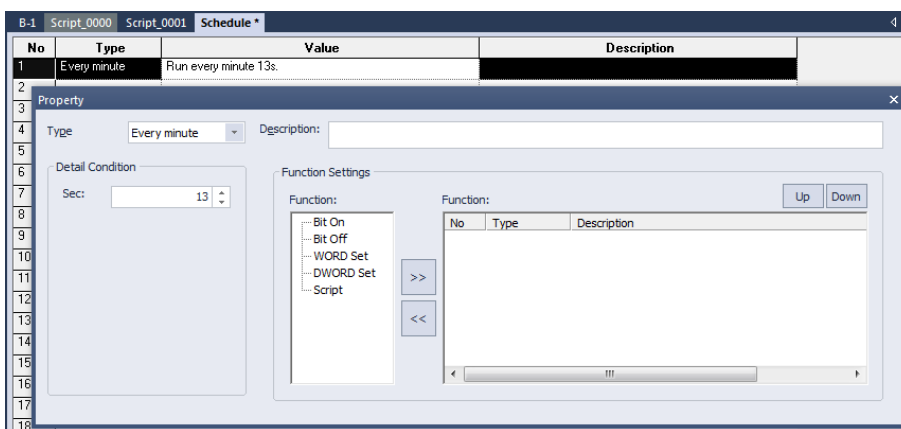

- 5 In the **Function Settings**, click [Script] ► [>>].

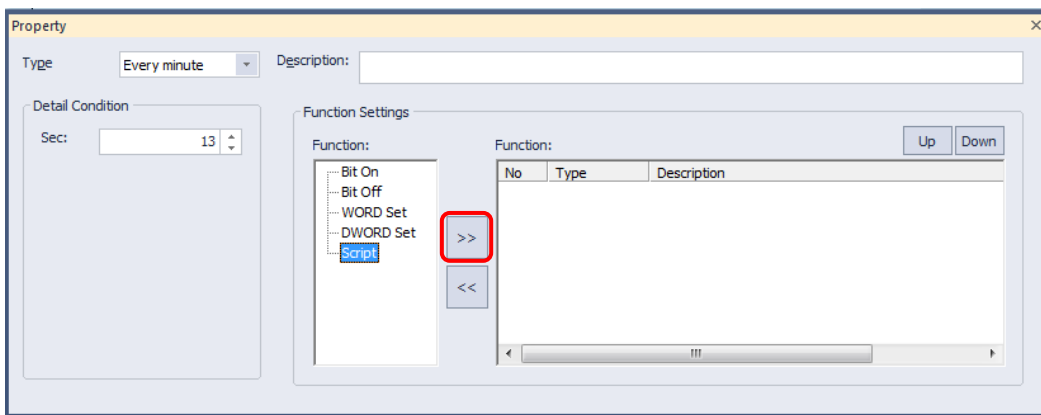

- 6 Select a script from the drop-down list and click [OK].

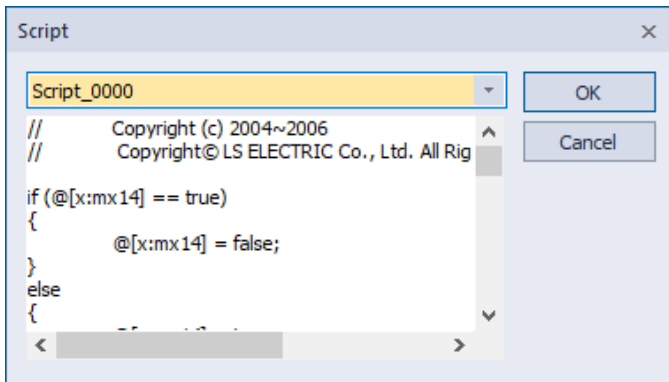

- 7 If necessary, click [Up] or [Down] to prioritize the script.
- 8 Close the Property window or specify additional scheduler scripts, as desired. Your changes are saved automatically.

4.2.2.6 Creating Object Scripts

- 1 Create a script, as described in sections 4.2.2.1 and 4.2.2.2 .
- 2 Create an object. For more information about creating objects, refer to <2.3.4 Inserting Figures or Objects>. After creating an object, the Properties window will appear for the object.
- 3 Click [Operation] in the Properties window.
- 4 Check the checkbox next to **Use Script**.

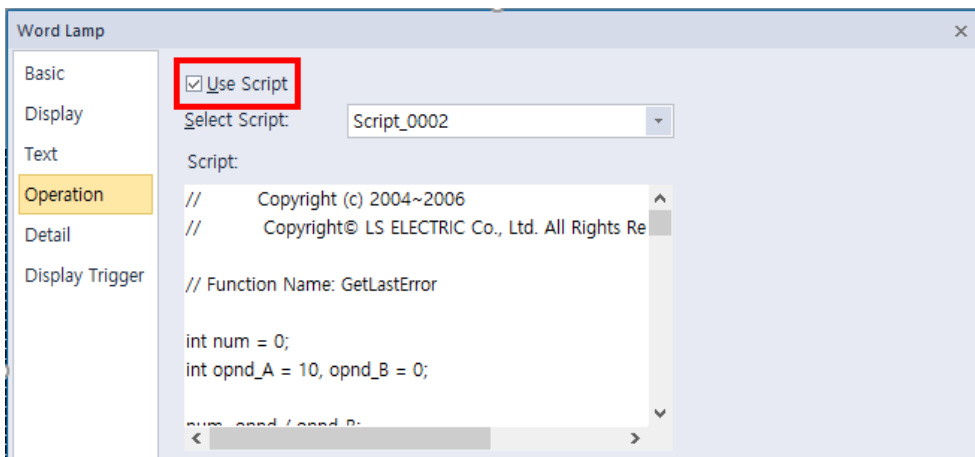

- 5 Select a script.
- 6 Click [OK].

Note

- Scripts can only be configured for certain types of objects. The [Use Script] option is not available if the object does not support use of scripts.
- If you delete a script that is applied to objects in your project, an error will occur during the data check.

4.2.2.7 Editing Scripts

To find part of a script:

- 1 With the Script tab open in the editing area, click [Tool] ► [Find in Active Screen].
- 2 Specify the data to find in the pop-up window.

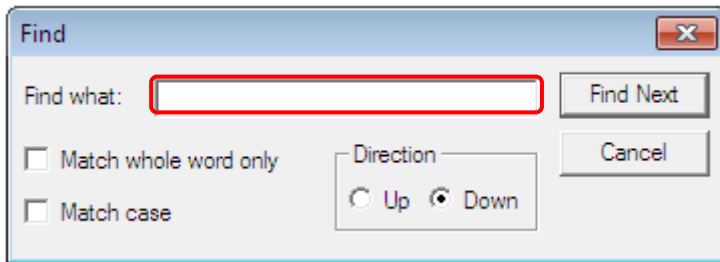

- 3 Specify matching and direction options, as desired.
- 4 Click [Find Next] to find the next instance of the data.

To replace part of a script:

- 1 With the Script tab open in the editing area, click [Tool] ► [Replace in Active Screen].
- 2 Specify the data to find in the pop-up window.

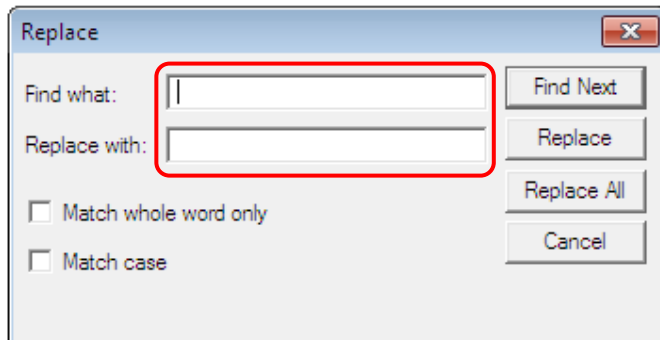

- 3 Specify matching options, as desired.
- 4 Click [Replace] to replace data instances one at a time or you can click [Replace All] to replace all data instances that match your search at once.

To move to a specific line in the script:

- 1 With the script tab open, right-click on the script editing area.
- 2 Click [Goto].

```

B-1 * Script_0000 *
1 // Copyright (c) 2004~2006
2 // Copyright© LS ELECTRIC Co., Ltd. All Rights Reserved.
3
4
5 if (@[X:MX14] == true)
6 {
7
8 }
9 else
10 {
11
12 }
13
14
15
16
17
18 EF
19 {
20
21
22

```

3 Enter a line number and click [Goto].

Note

You can add single-line or multi-line comments to your scripts. To add a single-line comment, enter two backslashes (//) in front of the comment. To add a multi-line comment, enter backslashes and asterisks (/ * */) at the start and end of the comment, as shown in the below example.

```

// This is a single line comment.
/* This is line 1 of a multi-line comment.
   This is line 2 of a multi-line comment.
   This is line 3 of a multi-line comment. */

```

4.2.2.8 Understanding Script Error Handling

If an error occurs during a script execution, statements after the error are skipped without processing. Then, the processing is resumed after an ERROR control statement is encountered, as shown in the screenshot below.

Statements within the ERROR control statement are executed only when an error occurs during the script execution.

```

4 // Function Name: GetLastError
5
6 int num = 0; Executed
7 int opnd_A = 10, opnd_B = 0; Executed
8
9 num=opnd / opnd_B; Divided by 0 ERROR
10 @[W:HW10] = num; Not executed
11
12 ERROR: Script execution resumes here.
13 {
14     int Error = GetLastError(); Executed
15 }
16
    
```

Script errors and descriptions are displayed in the Output tab at the bottom of the XP-Builder screen.

4.2.2.9 Understanding the Script Watchdog Function

The Watchdog function exists to avoid infinite loops or prevent scripts that are too long from hanging up processes. When a script exceeds the default time allotted (5 seconds), the Watchdog function is activated automatically and forces the script to end.

You can adjust the script watchdog time in the Project Property settings window.

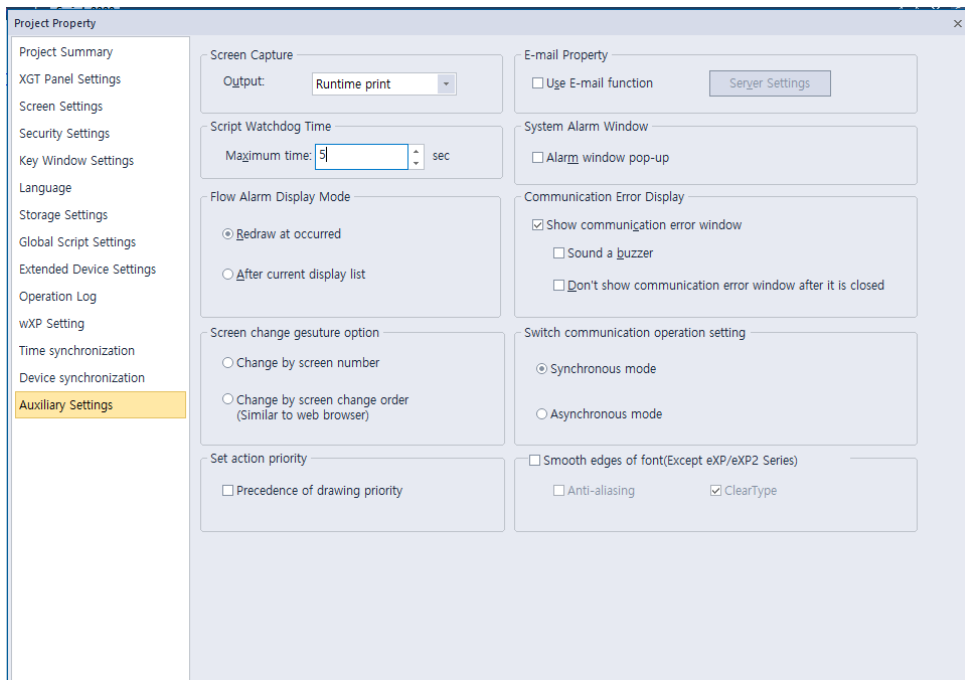

Script execution takes longer than any other action, so use conditional statements with care. Pay special attention to statements for which the run time is hard to predict, such as *for*, *while*, and *do-while* statements.

4.2.3 Using Scripts to Control XGT Panel Functions

Several scripts are available for controlling XGT panel functions, including system, print, and device functions.

4.2.3.1 Understanding System Functions

The table below describes script properties of the system functions.

Function	Description	Parameters														
HMIExit	The XGT Panel closes the monitor and moves to the menu screen. Example: <i>HMIExit();</i>	None														
InitHistoricalAlarm	Initializes the alarm area of the NVRAM. Existing alarms will be deleted. Example: <i>InitHistoricalAlarm();</i>	None														
InitLogging	Initializes the logging area of the NVRAM. Logged content will be deleted. If one of the history alarm numbers is invalid, this function will not work. Example: <i>InitLogging(1);</i>	<table border="1"> <tr> <td>Return value</td> <td>None</td> </tr> <tr> <td>Parameter 1</td> <td>intn LogNum: the logging number to be initialized</td> </tr> </table>	Return value	None	Parameter 1	intn LogNum: the logging number to be initialized										
Return value	None															
Parameter 1	intn LogNum: the logging number to be initialized															
SetTime	Changes the XGT Panel's clock. Example: <i>SetTime(@[W: %MW1000], @[W: %MW1001], @[W: : %MW1002], @[W: %MW1003], @[W: %MW1004], @[W: %MW1005]);</i> <i>SetTime(2013, 1, 30, 8, 10, 0);</i>	<table border="1"> <tr> <td>Return value</td> <td>None</td> </tr> <tr> <td>Parameter 1</td> <td>intn Year: Year</td> </tr> <tr> <td>Parameter 2</td> <td>intn Month: Month (1-12)</td> </tr> <tr> <td>Parameter 3</td> <td>intn Day: Day (0-31)</td> </tr> <tr> <td>Parameter 4</td> <td>IntnTime: Hour (0-23)</td> </tr> <tr> <td>Parameter 5</td> <td>intn Min: Minute (0-59)</td> </tr> <tr> <td>Parameter 6</td> <td>IntnSec: Second (0-59)</td> </tr> </table>	Return value	None	Parameter 1	intn Year: Year	Parameter 2	intn Month: Month (1-12)	Parameter 3	intn Day: Day (0-31)	Parameter 4	IntnTime: Hour (0-23)	Parameter 5	intn Min: Minute (0-59)	Parameter 6	IntnSec: Second (0-59)
Return value	None															
Parameter 1	intn Year: Year															
Parameter 2	intn Month: Month (1-12)															
Parameter 3	intn Day: Day (0-31)															
Parameter 4	IntnTime: Hour (0-23)															
Parameter 5	intn Min: Minute (0-59)															
Parameter 6	IntnSec: Second (0-59)															
ResetUSB	Resets the power to the USB ports on the XGT Panels. This function is not supported by the IPC series. Example: <i>if(@[X: HX00000] == true) ResetUSB ();</i>	None														

4.2.3.2 Understanding Print Functions

The table below describes script properties of the print functions.

Function	Description	Parameters
PrintAlarm	<p>Prints the alarm list. This function is not supported by the IPC series.</p> <p>Example:</p> <pre>if(@[X: %MX0] == true) { PrintAlarm(); }</pre>	None
PrintScreen	<p>Prints the current screen of the XGT Panel. Set the print option in the Auxiliary Settings tab of the project properties.</p> <p>The IPC series only supports printing to a file.</p> <p>Example:</p> <pre>if(@[X: %MX1] == true) { PrintScreen(); }</pre>	None

4.2.3.3 Understanding Screen Change Functions

Function	Description	Parameters
ChangeBaseScreen	<p>Changes the current screen to the screen number specified by the device. If the screen number is not assigned in the Project pane, the screen will not be changed.</p> <p>Example:</p> <pre>if(@[W: %MW000] >= 0) ChangeBaseScreen(10); else ChangeBaseScreen(@[W: %MW10]); //Constant is 10. Device is %MW10.</pre>	<p>Intr Base Screen Number: Input the screen number to change. You can input a real number or designate a word device to provide the value.</p>

4.2.3.4 Understanding Script Functions

The table below describes properties of the script function.

Function	Description	Parameters
GetLastError	Return errors that occur during script execution. Example: <pre> intn um =0, a = 10, b = 0; int error; num = a/b; ERROR: { error = GetLastError(); } </pre>	See the following table.

The GetLastError function returns the values listed in the table below.

Value	Description
0: Steady State	Set a steady state.
1: Shut down	The program was shut down normally.
2: Memory error	A stack address value was not properly read or written.
3: Direct Variable Memory error	A direct variable address was not properly read or written.
4: Temporary Variable Memory error	A temporary variable address was not properly read or written.
5: Internal Function Processing	An internal function defined in XP-Builder did not perform correctly.
6: Data error	A variable data value is invalid (used for debugging).
7: Invalid Data	A data value is invalid when writing variables (used for debugging).
8: Divide by 0 Error	Illegal operation: division by zero.
9: Opcode Error	Invalid opcode
10: Arrangement Subscript Excess	An arrangement subscript exceeds the maximum size.
11: Range Excess	Not used.
12: Function Error	Not used.
13: Semi Error	Not used.
14: Watchdog Time Error	The watchdog time has been exceeded.
15: Duplication Function Number Error(10)	More than 10 scripts called.
16: Dead lock State	Not used.

Value	Description
17: Memory Error	An attempt was made to reference something outside of the global variable area (g_DataBuffer).
18: Memory Error	The pointer's memory exceeds the range of the assigned variable.
19: Memory Error	The pointer's class is incorrect (available only for global variables or stack variables).
20: Memory Error	The wrong type was entered (when a value other than the declared variable type was entered).

4.2.3.5 Understanding String Functions

The following table describes properties of the string functions.

Function	Description	Parameters						
Strcat	<p>Adds a source string behind a target string. When the target string plus the source string is bigger than the character type's variable, the string is not added (false is returned).</p> <p>Example: <code>char szSrc[10] = "12345";</code> <code>szDst[10] = "abcd";</code> <code>Strcat(&szDst, &szSrc);</code> //The value of szDst is "abcd12345".</p>	<table border="1"> <tbody> <tr> <td>Return value</td> <td>bool: Whether or not the string is added.</td> </tr> <tr> <td>Parameter 1</td> <td>char* pszDst: The target string (the address of the character type's variable).</td> </tr> <tr> <td>Parameter 2</td> <td>char* pszSrc: The source string (the address of the character type's variable).</td> </tr> </tbody> </table>	Return value	bool: Whether or not the string is added.	Parameter 1	char* pszDst: The target string (the address of the character type's variable).	Parameter 2	char* pszSrc: The source string (the address of the character type's variable).
Return value	bool: Whether or not the string is added.							
Parameter 1	char* pszDst: The target string (the address of the character type's variable).							
Parameter 2	char* pszSrc: The source string (the address of the character type's variable).							
Strcmp	<p>Compares two texts and, if they are the same, returns 0.</p> <p>Example: <code>char szStr1[10] = "12345";</code> <code>char szStr2[10] = "12345";</code> <code>intn Result;</code> <code>nResult = Strcmp(&szStr1, &szStr2);</code> //The value of nResult is 0.</p>	<table border="1"> <tbody> <tr> <td>Return value</td> <td> int: Return the result of the comparison: <ul style="list-style-type: none"> • Negative: pszString1 < pszString2 • 0: Same string • Positive: pszString1 > pszString2 </td> </tr> <tr> <td>Parameter 1</td> <td>char* pszDst: The target string (the address of the character type's variable).</td> </tr> <tr> <td>Parameter 2</td> <td>char* pszSrc: The source string (the address of the</td> </tr> </tbody> </table>	Return value	int: Return the result of the comparison: <ul style="list-style-type: none"> • Negative: pszString1 < pszString2 • 0: Same string • Positive: pszString1 > pszString2 	Parameter 1	char* pszDst: The target string (the address of the character type's variable).	Parameter 2	char* pszSrc: The source string (the address of the
Return value	int: Return the result of the comparison: <ul style="list-style-type: none"> • Negative: pszString1 < pszString2 • 0: Same string • Positive: pszString1 > pszString2 							
Parameter 1	char* pszDst: The target string (the address of the character type's variable).							
Parameter 2	char* pszSrc: The source string (the address of the							

Function	Description	Parameters	
Strcpy	Copies a string from the source string to the target string. If the length of the source string is longer than the character type's variable, it cannot be copied (false is returned). Example: <i>char szSrc[10] = "12345", szDst[10]; Strcpy(&szDst, &szSrc);</i>		character type's variable).
		Return value	bool: Whether or not the string is copied.
		Parameter 1	char* pszDst: The target string (the address of the character type's variable).
		Parameter 2	char* pszSrc: The source string (the address of the character type's variable).
Strlen	Lengthens the string. Example: <i>char buf[10] = "12345"; intn Len; nLen = Strlen(&buf); //The value of nLen is 5.</i>	Return value	int: The length of string
		Parameter 1	char* pszString: The address of the character type's variable.

4.2.3.6 Understanding Device Functions

The table below describes properties of the device functions.

Function	Description	Parameters	
CopyData	Reads data from the source device and inputs it into a destination device. Example: <i>CopyData(@[W: %MW000], @[W: %MW100], 10);</i>	Return value	None
		Parameter 1	DEVICE src: The source device to copy from
		Parameter 2	DEVICE dst: The destination device
		Parameter 3	intn Count: The number of devices
CopyDataEx	Reads data from the source device up to the source offset and inputs it into the destination device up to the destination offset. Example: <i>int index; if(@[X: %IX0.0.0] == true)</i>	Return value	BOOL: If the device address is exceeded, FALSE will be returned.
		Parameter 1	DEVICE src: The source device to

Function	Description	Parameters											
	<pre> { index = 0; } else { index = 100; } CopyDataEx(@[W: %MW000], 0, @[W: %MW100], index, 10); /* If statement is true, offsets 10 word values, from %MW000 to %MW100. If statement is false, offsets 10 word values from %MW000 to %MW200. */ </pre>	<table border="1"> <tr> <td></td> <td>copy from</td> </tr> <tr> <td>Parameter 2</td> <td>intn SrcOffset: Offset of the source device</td> </tr> <tr> <td>Parameter 3</td> <td>DEVICE dst: The destination device</td> </tr> <tr> <td>Parameter 4</td> <td>intn DstOffset: Offset of the destination device</td> </tr> <tr> <td>Parameter 5</td> <td>intn CopyCount: The number of devices</td> </tr> </table>		copy from	Parameter 2	intn SrcOffset: Offset of the source device	Parameter 3	DEVICE dst: The destination device	Parameter 4	intn DstOffset: Offset of the destination device	Parameter 5	intn CopyCount: The number of devices	
	copy from												
Parameter 2	intn SrcOffset: Offset of the source device												
Parameter 3	DEVICE dst: The destination device												
Parameter 4	intn DstOffset: Offset of the destination device												
Parameter 5	intn CopyCount: The number of devices												
SetData	<p>Input values to a device.</p> <p>Example:</p> <pre> intn Loop; for(nLoop = 0; nLoop<10; nLoop++) SetData(@[W: %MW100], nLoop, 0); //Set "0" in devices from %MW100 to %MW109. </pre>	<table border="1"> <tr> <td>Return value</td> <td>BOOL: If the device address is exceeded, FALSE will be returned.</td> </tr> <tr> <td>Parameter 1</td> <td>DEVICE src: The source device</td> </tr> <tr> <td>Parameter 2</td> <td>intn SrcOffset: Offset of the source device</td> </tr> <tr> <td>Parameter 3</td> <td>intn Value: Value</td> </tr> </table>	Return value	BOOL: If the device address is exceeded, FALSE will be returned.	Parameter 1	DEVICE src: The source device	Parameter 2	intn SrcOffset: Offset of the source device	Parameter 3	intn Value: Value			
Return value	BOOL: If the device address is exceeded, FALSE will be returned.												
Parameter 1	DEVICE src: The source device												
Parameter 2	intn SrcOffset: Offset of the source device												
Parameter 3	intn Value: Value												
GetData	<p>Retrieves and adds values from a device.</p> <p>Example:</p> <pre> intn Loop, nValue; for(nLoop = 0; nLoop<10; nLoop++) { GetData(@[W: %MW100], nLoop, &nValue); nValue += nValue; } //Retrieve and add values from %MW100 to %MW109. </pre>	<table border="1"> <tr> <td>Return value</td> <td>BOOL: If the device address is exceeded, FALSE will be returned.</td> </tr> <tr> <td>Parameter 1</td> <td>DEVICE src: The source device</td> </tr> <tr> <td>Parameter 2</td> <td>intn SrcOffset: Offset of the source device</td> </tr> <tr> <td>Parameter 3</td> <td>int* pRetVal: The value returned from the device.</td> </tr> </table>	Return value	BOOL: If the device address is exceeded, FALSE will be returned.	Parameter 1	DEVICE src: The source device	Parameter 2	intn SrcOffset: Offset of the source device	Parameter 3	int* pRetVal: The value returned from the device.			
Return value	BOOL: If the device address is exceeded, FALSE will be returned.												
Parameter 1	DEVICE src: The source device												
Parameter 2	intn SrcOffset: Offset of the source device												
Parameter 3	int* pRetVal: The value returned from the device.												

Function	Description	Parameters								
SetStrData	<p>Copies a specified length of text string from a character type variable to a device.</p> <p>Example: <i>Char a[6] = "abcde"; // Device "HW0000" has character value "abcde"</i></p> <p><i>SetStrData (@[W:HW00000], 0, &a);</i></p>	<table border="1"> <tr> <td>Return value</td> <td>BOOL: If the device address is exceeded, or if the device is read-only, FALSE will be returned.</td> </tr> <tr> <td>Parameter 1</td> <td>DEVICE dst: The target device</td> </tr> <tr> <td>Parameter 2</td> <td>intn nDstOffset: Offset of the target device</td> </tr> <tr> <td>Parameter 3</td> <td>Char*patrValue: Char array address variable where the source string is located.</td> </tr> </table>	Return value	BOOL: If the device address is exceeded, or if the device is read-only, FALSE will be returned.	Parameter 1	DEVICE dst: The target device	Parameter 2	intn nDstOffset: Offset of the target device	Parameter 3	Char*patrValue: Char array address variable where the source string is located.
Return value	BOOL: If the device address is exceeded, or if the device is read-only, FALSE will be returned.									
Parameter 1	DEVICE dst: The target device									
Parameter 2	intn nDstOffset: Offset of the target device									
Parameter 3	Char*patrValue: Char array address variable where the source string is located.									

Note

- When copying data, the source and destination devices must be of the same type. Otherwise, communication will fail.
- If a device address exceeds the upper limit, data will not be copied.

4.2.3.7 Understanding Communication Functions

The table below describes properties of the communication functions.

Function	Description	Parameters								
ADD_SUM	<p>Calculates and returns the sum of entered data.</p> <p>Example: <i>intn Result; char buf[5] = {1, 2, 3, 4, 5}; ADD_SUM(&buf[0], 5, &nResult);</i></p>	<table border="1"> <tr> <td>Return value</td> <td>BOOL: If the number is beyond the range of the buffer, FALSE is returned.</td> </tr> <tr> <td>Parameter 1</td> <td>char* pBuffer: The buffer for calculation</td> </tr> <tr> <td>Parameter 2</td> <td>intn Count: The byte number to be calculated</td> </tr> <tr> <td>Parameter 3</td> <td>int* nResult: The calculated value</td> </tr> </table>	Return value	BOOL: If the number is beyond the range of the buffer, FALSE is returned.	Parameter 1	char* pBuffer: The buffer for calculation	Parameter 2	intn Count: The byte number to be calculated	Parameter 3	int* nResult: The calculated value
Return value	BOOL: If the number is beyond the range of the buffer, FALSE is returned.									
Parameter 1	char* pBuffer: The buffer for calculation									
Parameter 2	intn Count: The byte number to be calculated									
Parameter 3	int* nResult: The calculated value									
ADD_SUM_1S	<p>Calculates and returns the sum in one's complement.</p> <p>Example: <i>intn Result; char buf[5] = {1, 2, 3, 4, 5};</i></p>	<table border="1"> <tr> <td>Return value</td> <td>BOOL: If the number is beyond the range of the buffer, FALSE is returned.</td> </tr> </table>	Return value	BOOL: If the number is beyond the range of the buffer, FALSE is returned.						
Return value	BOOL: If the number is beyond the range of the buffer, FALSE is returned.									

Function	Description	Parameters								
	<i>ADD_SUM_1S(&buf[0], 5, &nResult);</i>	<table border="1"> <tr> <td>Parameter 1</td> <td>char* pBuffer: The buffer for calculation</td> </tr> <tr> <td>Parameter 2</td> <td>intn Count: The byte number to be calculated</td> </tr> <tr> <td>Parameter 3</td> <td>int* nResult: The calculated value</td> </tr> </table>	Parameter 1	char* pBuffer: The buffer for calculation	Parameter 2	intn Count: The byte number to be calculated	Parameter 3	int* nResult: The calculated value		
Parameter 1	char* pBuffer: The buffer for calculation									
Parameter 2	intn Count: The byte number to be calculated									
Parameter 3	int* nResult: The calculated value									
ADD_SUM_2S	<p>Calculates and returns the sum in two's complement.</p> <p>Example: <i>intn Result;</i> <i>char buf[5] = {1, 2, 3, 4, 5};</i> <i>ADD_SUM_2S(&buf[0], 5, &nResult);</i></p>	<table border="1"> <tr> <td>Return value</td> <td>BOOL: If the number is beyond the range of the buffer, FALSE is returned.</td> </tr> <tr> <td>Parameter 1</td> <td>char* pBuffer: The buffer for calculation</td> </tr> <tr> <td>Parameter 2</td> <td>intn Count: The byte number to be calculated</td> </tr> <tr> <td>Parameter 3</td> <td>int* nResult: The calculated value</td> </tr> </table>	Return value	BOOL: If the number is beyond the range of the buffer, FALSE is returned.	Parameter 1	char* pBuffer: The buffer for calculation	Parameter 2	intn Count: The byte number to be calculated	Parameter 3	int* nResult: The calculated value
Return value	BOOL: If the number is beyond the range of the buffer, FALSE is returned.									
Parameter 1	char* pBuffer: The buffer for calculation									
Parameter 2	intn Count: The byte number to be calculated									
Parameter 3	int* nResult: The calculated value									
CRC16	<p>Calculates and returns the 16-bit CRC value of entered data.</p> <p>Example: <i>intn Result;</i> <i>char buf[5] = {1, 2, 3, 4, 5};</i> <i>CRC16(&buf[0], 5, &nResult);</i></p>	<table border="1"> <tr> <td>Return value</td> <td>BOOL: If the number is beyond the range of the buffer, FALSE is returned.</td> </tr> <tr> <td>Parameter 1</td> <td>char* pBuffer: The buffer for calculation</td> </tr> <tr> <td>Parameter 2</td> <td>intn Count: The byte number to be calculated</td> </tr> <tr> <td>Parameter 3</td> <td>int* nResult: The calculated value</td> </tr> </table>	Return value	BOOL: If the number is beyond the range of the buffer, FALSE is returned.	Parameter 1	char* pBuffer: The buffer for calculation	Parameter 2	intn Count: The byte number to be calculated	Parameter 3	int* nResult: The calculated value
Return value	BOOL: If the number is beyond the range of the buffer, FALSE is returned.									
Parameter 1	char* pBuffer: The buffer for calculation									
Parameter 2	intn Count: The byte number to be calculated									
Parameter 3	int* nResult: The calculated value									
XOR_SUM	<p>Calculates and returns the XOR sum of entered data.</p> <p>Example: <i>intn Result;</i> <i>char buf[5] = {1, 2, 3, 4, 5};</i> <i>XOR_SUM(&buf[0], 5, &nResult);</i></p>	<table border="1"> <tr> <td>Return value</td> <td>BOOL: If the number is beyond the range of the buffer, FALSE is returned.</td> </tr> <tr> <td>Parameter 1</td> <td>char* pBuffer: The buffer for calculation</td> </tr> <tr> <td>Parameter 2</td> <td>intn Count: The byte number to be calculated</td> </tr> <tr> <td>Parameter 3</td> <td>int* nResult: The</td> </tr> </table>	Return value	BOOL: If the number is beyond the range of the buffer, FALSE is returned.	Parameter 1	char* pBuffer: The buffer for calculation	Parameter 2	intn Count: The byte number to be calculated	Parameter 3	int* nResult: The
Return value	BOOL: If the number is beyond the range of the buffer, FALSE is returned.									
Parameter 1	char* pBuffer: The buffer for calculation									
Parameter 2	intn Count: The byte number to be calculated									
Parameter 3	int* nResult: The									

Function	Description	Parameters								
			calculated value							
ReadFromIO	<p>If “nToRead” is “0”, data is read from the I/O device of a designated controller for the timeout specified in the communication settings. If “nToRead” is not “0”, the number of data specified is read, or data is read until the timeout is reached.</p> <p>Example: <code>char Response[32];</code> <code>int ReadSize;</code> <code>memset(&Response[0], 0, 32);</code> <code>ReadSize = ReadFromIO(0,</code> <code>&Response[0], 32);</code></p>	<table border="1"> <tr> <td>Return value</td> <td>int: The byte number of the read data</td> </tr> <tr> <td>Parameter 1</td> <td>intn Ctlr: The controller number (0-3)</td> </tr> <tr> <td>Parameter 2</td> <td>char* pBuffer: The buffer that will store the read data</td> </tr> <tr> <td>Parameter 3</td> <td>intn ToRead: The size of the data to be read</td> </tr> </table>	Return value	int: The byte number of the read data	Parameter 1	intn Ctlr: The controller number (0-3)	Parameter 2	char* pBuffer: The buffer that will store the read data	Parameter 3	intn ToRead: The size of the data to be read
Return value	int: The byte number of the read data									
Parameter 1	intn Ctlr: The controller number (0-3)									
Parameter 2	char* pBuffer: The buffer that will store the read data									
Parameter 3	intn ToRead: The size of the data to be read									
WriteToIO	<p>Transmit data to the I/O device of a designated PLC.</p> <p>Example: <code>char Command[6] = "ABCDEF";</code> <code>intn SentSize;</code> <code>nSentSize = WriteToIO(0,</code> <code>&Command[0], 6);</code></p>	<table border="1"> <tr> <td>Return value</td> <td>int: The byte number of the transmitted data</td> </tr> <tr> <td>Parameter 1</td> <td>intn Ctlr: The PLC number (0-16). If the controller number is 100, send data to LPT1 printer port.</td> </tr> <tr> <td>Parameter 2</td> <td>char* pBuffer: The data buffer to be transmitted.</td> </tr> <tr> <td>Parameter 3</td> <td>intn Size: The buffer size</td> </tr> </table>	Return value	int: The byte number of the transmitted data	Parameter 1	intn Ctlr: The PLC number (0-16). If the controller number is 100, send data to LPT1 printer port.	Parameter 2	char* pBuffer: The data buffer to be transmitted.	Parameter 3	intn Size: The buffer size
Return value	int: The byte number of the transmitted data									
Parameter 1	intn Ctlr: The PLC number (0-16). If the controller number is 100, send data to LPT1 printer port.									
Parameter 2	char* pBuffer: The data buffer to be transmitted.									
Parameter 3	intn Size: The buffer size									

4.2.3.8 Understanding Memory Functions

The table below describes properties of the memory functions.

Function	Description	Parameters				
HIBYTE	<p>Obtains the upper byte of the entered word values.</p> <p>Example: <code>intn Value = 0x1234;</code> <code>char nResult;</code> <code>nResult = HIBYTE(nValue);</code></p>	<table border="1"> <tr> <td>Return value</td> <td>char: Upper byte</td> </tr> <tr> <td>Parameter 1</td> <td>intn Value: The entered data</td> </tr> </table>	Return value	char: Upper byte	Parameter 1	intn Value: The entered data
Return value	char: Upper byte					
Parameter 1	intn Value: The entered data					
LOBYTE	<p>Obtains the lower byte of the entered word values.</p> <p>Example:</p>	<table border="1"> <tr> <td>Return value</td> <td>char: Lower byte</td> </tr> <tr> <td>Parameter 1</td> <td>intn Value: The</td> </tr> </table>	Return value	char: Lower byte	Parameter 1	intn Value: The
Return value	char: Lower byte					
Parameter 1	intn Value: The					

Function	Description	Parameters								
MAKEWORD	<pre>intn Value = 0x1234; char nResult; nResult = LOBYTE(nValue);</pre>	<table border="1"> <tr> <td></td> <td>entered data</td> </tr> </table>		entered data						
		entered data								
<p>Obtains word values with two entered byte values.</p> <p>Example: <pre>char cLow = 0x12, cHigh = 0x34; intn Result; nResult = MAKEWORD(cLow, cHigh); //The result is 0x3412.</pre></p>	<table border="1"> <tr> <td>Return value</td> <td>int: Word Value</td> </tr> <tr> <td>Parameter 1</td> <td>char cLow: Lower byte</td> </tr> <tr> <td>Parameter 2</td> <td>char cHigh: Upper byte</td> </tr> </table>	Return value	int: Word Value	Parameter 1	char cLow: Lower byte	Parameter 2	char cHigh: Upper byte			
Return value	int: Word Value									
Parameter 1	char cLow: Lower byte									
Parameter 2	char cHigh: Upper byte									
Memcpy	<p>Copies the data from the source buffer to the destination buffer.</p> <p>Example: <pre>char src[9] = "123456789", dst[4]; Memcpy(&src[2], &dst[0], 4);</pre></p>	<table border="1"> <tr> <td>Return value</td> <td>BOOL: If the number is beyond the range of the buffer, FALSE is returned.</td> </tr> <tr> <td>Parameter 1</td> <td>char * pDstData: The destination buffer</td> </tr> <tr> <td>Parameter 2</td> <td>char * pSrcData: The source buffer to be copied</td> </tr> <tr> <td>Parameter 3</td> <td>intn DataSize: The data number to be copied (char number)</td> </tr> </table>	Return value	BOOL: If the number is beyond the range of the buffer, FALSE is returned.	Parameter 1	char * pDstData: The destination buffer	Parameter 2	char * pSrcData: The source buffer to be copied	Parameter 3	intn DataSize: The data number to be copied (char number)
Return value	BOOL: If the number is beyond the range of the buffer, FALSE is returned.									
Parameter 1	char * pDstData: The destination buffer									
Parameter 2	char * pSrcData: The source buffer to be copied									
Parameter 3	intn DataSize: The data number to be copied (char number)									
Memset	<p>Initializes the buffer with a designated value.</p> <p>Example: <pre>char src[9]; Memset(&src[0], 0, 10);</pre></p>	<table border="1"> <tr> <td>Return value</td> <td>BOOL: If the number is beyond the range of the buffer, FALSE is returned.</td> </tr> <tr> <td>Parameter 1</td> <td>char * pSrcData: The source buffer to be copied</td> </tr> <tr> <td>Parameter 2</td> <td>char byData: Value to be initialized</td> </tr> <tr> <td>Parameter 3</td> <td>intn DataSize: The data number to be initialized (char number)</td> </tr> </table>	Return value	BOOL: If the number is beyond the range of the buffer, FALSE is returned.	Parameter 1	char * pSrcData: The source buffer to be copied	Parameter 2	char byData: Value to be initialized	Parameter 3	intn DataSize: The data number to be initialized (char number)
Return value	BOOL: If the number is beyond the range of the buffer, FALSE is returned.									
Parameter 1	char * pSrcData: The source buffer to be copied									
Parameter 2	char byData: Value to be initialized									
Parameter 3	intn DataSize: The data number to be initialized (char number)									
Memcmp	<p>Compares two buffers.</p> <p>Example: <pre>char src[9] = "123456789", dst[4] = "3456"; intn Result;</pre></p>	<table border="1"> <tr> <td>Return value</td> <td>BOOL: If the number is beyond the range of the buffer, FALSE is returned.</td> </tr> </table>	Return value	BOOL: If the number is beyond the range of the buffer, FALSE is returned.						
Return value	BOOL: If the number is beyond the range of the buffer, FALSE is returned.									

Function	Description	Parameters								
	<i>Memcmp(&src[2], &dst[0], 4, &nResult);</i>	<table border="1"> <tr> <td>Parameter 1</td> <td>char* pBuffer1: buffer 1</td> </tr> <tr> <td>Parameter 2</td> <td>char* pBuffer2: buffer 2</td> </tr> <tr> <td>Parameter 3</td> <td>intn DataSize: The data number to be compared (char number)</td> </tr> <tr> <td>Parameter 4</td> <td>int* nResult: If the two buffers are the same, 0 is returned. If they are different, 1 is returned.</td> </tr> </table>	Parameter 1	char* pBuffer1: buffer 1	Parameter 2	char* pBuffer2: buffer 2	Parameter 3	intn DataSize: The data number to be compared (char number)	Parameter 4	int* nResult: If the two buffers are the same, 0 is returned. If they are different, 1 is returned.
Parameter 1	char* pBuffer1: buffer 1									
Parameter 2	char* pBuffer2: buffer 2									
Parameter 3	intn DataSize: The data number to be compared (char number)									
Parameter 4	int* nResult: If the two buffers are the same, 0 is returned. If they are different, 1 is returned.									
SwapWord	Swap upper and lower byte data values of Word data. Example: <i>intn Src = 0x1234, nResult;</i> <i>nResult = SwapWord(nSrc);</i> <i>//The value of nResult is 0x3412.</i>	<table border="1"> <tr> <td>Return value</td> <td>int: The swapped data value</td> </tr> <tr> <td>Parameter 1</td> <td>intn SrcData: The data value to be swapped</td> </tr> </table>	Return value	int: The swapped data value	Parameter 1	intn SrcData: The data value to be swapped				
Return value	int: The swapped data value									
Parameter 1	intn SrcData: The data value to be swapped									
SwapDWord	Swap upper and lower word data values of DWord data. Example: <i>intn Src = 0x12345678, nResult;</i> <i>nResult = SwapDWord(nSrc);</i> <i>//The value of nResult is 0x56781234.</i>	<table border="1"> <tr> <td>Return value</td> <td>int: The swapped data value</td> </tr> <tr> <td>Parameter 1</td> <td>intn SrcData: The data value to be swapped</td> </tr> </table>	Return value	int: The swapped data value	Parameter 1	intn SrcData: The data value to be swapped				
Return value	int: The swapped data value									
Parameter 1	intn SrcData: The data value to be swapped									

4.2.3.9 Understanding Data Conversion Functions

The table below describes properties of the data conversion functions.

Function	Description	Parameters								
ASCII2HEX	Converts ASCII data to hexadecimal data. Example: <i>char buf[4] = "1234";</i> <i>intn Result;</i> <i>ASCII2HEX(&buf[0], nResult, 4);</i> <i>//The value of nResult is 0x1234.</i>	<table border="1"> <tr> <td>Return value</td> <td>BOOL: If the number is beyond the range of the buffer, FALSE is returned.</td> </tr> <tr> <td>Parameter 1</td> <td>char* pSrcBuffer: The source buffer to be converted</td> </tr> <tr> <td>Parameter 2</td> <td>int* pRetVal: The variable that will store the data to be converted</td> </tr> <tr> <td>Parameter 3</td> <td>intn Count: The</td> </tr> </table>	Return value	BOOL: If the number is beyond the range of the buffer, FALSE is returned.	Parameter 1	char* pSrcBuffer: The source buffer to be converted	Parameter 2	int* pRetVal: The variable that will store the data to be converted	Parameter 3	intn Count: The
Return value	BOOL: If the number is beyond the range of the buffer, FALSE is returned.									
Parameter 1	char* pSrcBuffer: The source buffer to be converted									
Parameter 2	int* pRetVal: The variable that will store the data to be converted									
Parameter 3	intn Count: The									

Function	Description	Parameters	
			number of bytes to be converted (1-8)
HEX2ASCII	<p>Converts hexadecimal data to ASCII data.</p> <p>Example: <code>char buf[4];</code> <code>intn Src = 0x1234;</code> <code>HEX2ASCII (nSrc, &buf[0], 4);</code></p>	Return value	<p>BOOL: If the data number to be converted is not between 1 and 8, or the size of the pDstBuffer is lower than that number, FALSE is returned.</p>
		Parameter 1	<p>intn Value: The value to be converted</p>
		Parameter 2	<p>char* pDstBuffer: The destination buffer that will store the data to be converted</p>
		Parameter 3	<p>intn Count: Number of bytes to be converted (1-8)</p>
ASCII2DEC	<p>Converts ASCII data to decimal data.</p> <p>Example: <code>char buf[4] = "1234";</code> <code>intn Result;</code> <code>ASCII2HEX(&buf[0], nResult, 4);</code> //The value of nResult is 1234.</p>	Return value	<p>BOOL: If the number is beyond the range of the buffer, FALSE is returned.</p>
		Parameter 1	<p>char* pSrcBuffer: The source buffer to be converted</p>
		Parameter 2	<p>int* pRetVal: The variable that will store the data to be converted</p>
		Parameter 3	<p>intn Count: The number of bytes to be converted (1-10)</p>
DEC2ASCII	<p>Converts decimal data to ASCII data.</p> <p>Example: <code>char buf[4];</code> <code>intn Src = 1234;</code> <code>HEX2ASCII (nSrc, &buf[0], 4);</code></p>	Return value	<p>BOOL: If the data number to be converted is not between 1 and 8 or the size of pDstBuffer is</p>

Function	Description	Parameters								
		<table border="1"> <tr> <td></td> <td>lower than that number, FALSE is returned.</td> </tr> <tr> <td>Parameter 1</td> <td>intn Value: The value to be converted</td> </tr> <tr> <td>Parameter 2</td> <td>char* pDstBuffer: The destination buffer that will store the converted data</td> </tr> <tr> <td>Parameter 3</td> <td>intn Count: The number of bytes to be converted (1-10)</td> </tr> </table>		lower than that number, FALSE is returned.	Parameter 1	intn Value: The value to be converted	Parameter 2	char* pDstBuffer: The destination buffer that will store the converted data	Parameter 3	intn Count: The number of bytes to be converted (1-10)
	lower than that number, FALSE is returned.									
Parameter 1	intn Value: The value to be converted									
Parameter 2	char* pDstBuffer: The destination buffer that will store the converted data									
Parameter 3	intn Count: The number of bytes to be converted (1-10)									

Note

If data that cannot be converted is encountered in the buffer, data conversion will stop. For example, when converting {"1","A","B","3","K","2","8"} from ASCII to hexadecimal, the result is {0x1AB3}, because the conversion cannot be completed.

4.2.3.10 Understanding Other Functions

The following table describes properties of other functions.

Function	Description	Parameters
BacklightOn	Turns the XGT Panel LCD on or off. This function is not supported by the IPC series. Example: <i>if(@[X: HX100] == true)</i> <i>BacklightOn(true);</i>	Bool bOn: Backlight is turned on or off.
Buzzer	Sound the buzzer for a specified time (50 ms). This function is not supported by the IPC series. Example: <i>if(@[X: HX100] == true)</i> <i>Buzzer();</i>	None
SetBuzzerEnable	Turn the buzzer on or off. This function is not supported by the IPC series. Example: <i>if(@[X: HX100] == true)</i> <i>{</i> <i>SetBuzzerEnable(true);</i>	Bool bEnable: Buzzer is turned on or off.

Function	Description	Parameters
ShowStatusbar	<pre> Buzzer(); } </pre> <p>Show or hide the status bar. The status bar appears and then disappears automatically after a specified time. This function is not supported by the IPC series.</p> <p>Example: <pre> if(@[X:HX100] == true) ShowStatusbar(); </pre> </p>	<p>Bool bShow: Show the status bar.</p>
Sleep	<p>Pause scripts for a specified time.</p> <p>Example: <pre> Int nLoop; for(nLoop = 0; nLoop<10; nLoop++) { Buzzer(); Sleep(500); } </pre> </p>	<p>Int nSleepTime: Time to be stopped temporarily (ms)</p>
RunExtProgram	<p>Runs external program. Set as char array.</p> <p>Example: <pre> char a[100] = "\\FlashDisk\\FILETEST.exe"; char b[5] = ""; if(@[x:HS0000.D] == true) { RunExtProgram (&a, &b); } </pre> </p>	<p>First: Path of the program. Second: Parameter (eg. -silent)</p>

4.3 Objects

Objects can change appearance, based on monitored data values. The subsections that follow explain what each object in XP-Builder can do and how to change its settings. For more information about drawing objects, refer to **<2.3.4.3 Drawing Objects>**.

You can set conditional settings for objects to change properties, such as the background color, frame color, outline, text display, and more, as shown in the below table.

Object	Settings
Switch Object	Operation condition/Lamp condition
Word Lamp	Image and text properties
Word Message	Image color/Image background color/Text color/Text
Numeric Input Numeric Display	Image background color/Text color/Flashing
Word Window	The window number to move
Word Part	The part number to move
Bar Graph	The background color to be filled/The color to be filled
Pie Graph	The background color to be filled/The color to be filled
Meter Graph	The pointer color
Closed Graph	The background color to be filled/The color to be filled

To set a conditional expression, click  in the object property window to register it.



The Range Edit window will appear, as shown below. The window may appear different for each object.

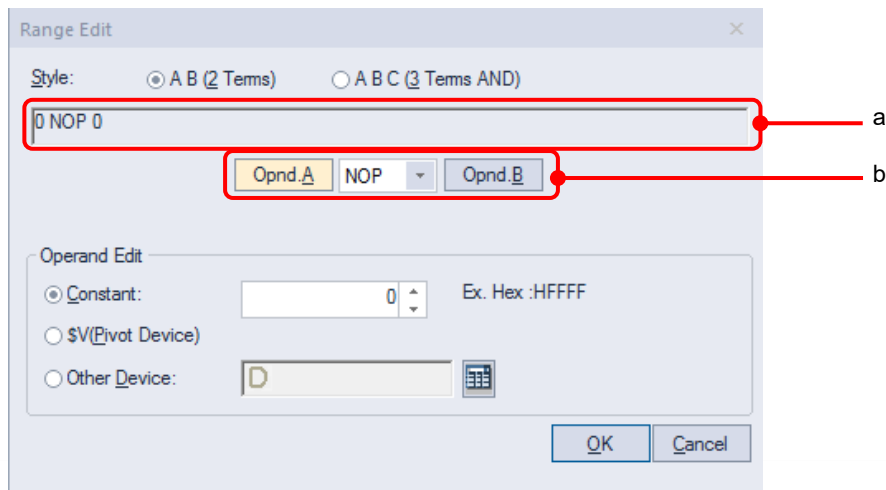

Function	Description
Style	Select a format for inputting conditional expressions (two terms or three terms).
a. Preview Expressions	Preview the conditional expression.
b. Operand	Set the operand and operator to set the range.
Constant	Set the number directly for the operand.
\$V(Standard Device)	Set the standard device value that the object is monitoring as the operand.
Other Device	Set the other device value as the operand.

Note

Refer to the below table for the minimum and maximum constant values based on the device size.

Device size	Device type	Minimum	Maximum
16 bit	Signed decimal	-32768	32767
16 bit	Unsigned decimal	0	65535
16 bit	BCD	0	9999
32 bit	Signed decimal	-2147483648	2147483647
32 bit	Unsigned decimal	0	4294967295
32 bit	BCD	0	99999999

4.3.1 Lamp Objects

Lamp objects change shape or form based on the state of the PLC devices that they are connected to. Lamp objects come in three types: bit lamps, word lamps, and N-state lamps. Bit lamps change based on the on/off state, word lamps change based on the text value, and N-state lamps change based on up to five device statuses.

Note

- If a lamp object is not connected to a PLC device, the lamp is not displayed on the XGT Panel.
- The lamp displays the default image if the connection with PLC device fails before 1 scan is completed.
 - ※ For details, refer to **<Appendix 5. Object Display Rule before Communication Connection>**.
- Do not overlay lamps on top of other objects. They may not be displayed correctly.

4.3.1.1 Bit Lamp

The form of a bit lamp changes based on the on/off state of the connected device. This section describes available settings for bit lamp objects.

- **Basic:** The basic settings for bit lamp objects are shown in the screenshots below.



- **Device:** Enter a device or tag address directly into the input field or click the keypad icon to the right to specify a device or tag address. When you click the keypad icon to open the Device window you can also specify network settings, if necessary.
- **Description:** Enter a description for the object.

- **Display:** The display settings for bit lamp objects are shown in the screenshot below.

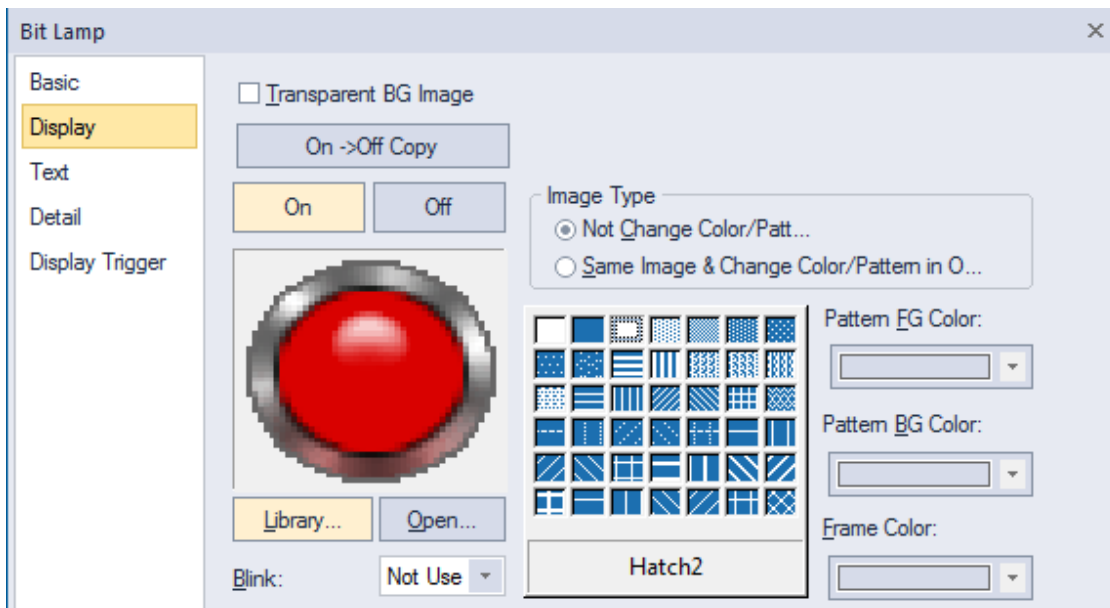

- **Transparent BG Image:** Check the checkbox to make the image background transparent. You cannot use a transparent background and the reverse image setting at the same time.
- **On:** Click to configure options for the object in the “On” state.
- **Off:** Click to configure options for the object in the “Off” state.
- **Image Type:** Set whether or not to change colors and patterns when switching between “On” and “Off” states. If you select the change color or pattern option, you must select a vector image for the object. To view characteristics of raster or vector images, refer to **<2.4.1 Managing Graphic Libraries>**.

Not Change Color/Pattern	Use the original image. You can apply the pattern or color to the image. Select the image to display for the “On” or ”Off” status from raster, vector, or user-registered images.
Same Image & Change Color/Pattern in On/Off	Select a vector image. You cannot select a raster image. Apply a pattern or color to the image.

- **Library:** Click to select an image from an image library.
- **Open:** Click to browse images on your computer. When you select an image from your computer, it will be added to the image library automatically.
- **Pattern:** Click a pattern to apply to the image. This option is available only when you select the change color or pattern option in **Image Type**. Patterns are applied to specific parts of objects, but not to the frames. The frames are different for each image. Refer to the below examples.

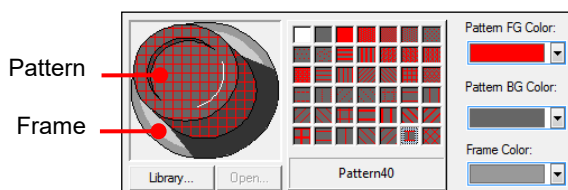

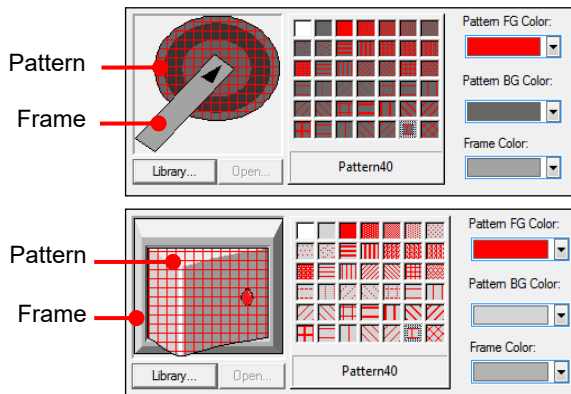

- **Pattern FG Color:** Set a color for the foreground pattern.
- **Pattern BG Color:** Set a color for the background pattern.
- **Frame Color:** Set a frame color.
- **Blink:** Set a blink speed for the object:

Not use	The object will not blink.
Slow	The object will blink every three seconds.
Normal	The object will blink every two seconds.
Fast	The object will blink every second.

- **Text:** The text settings for bit lamp objects are shown in the screenshot below.

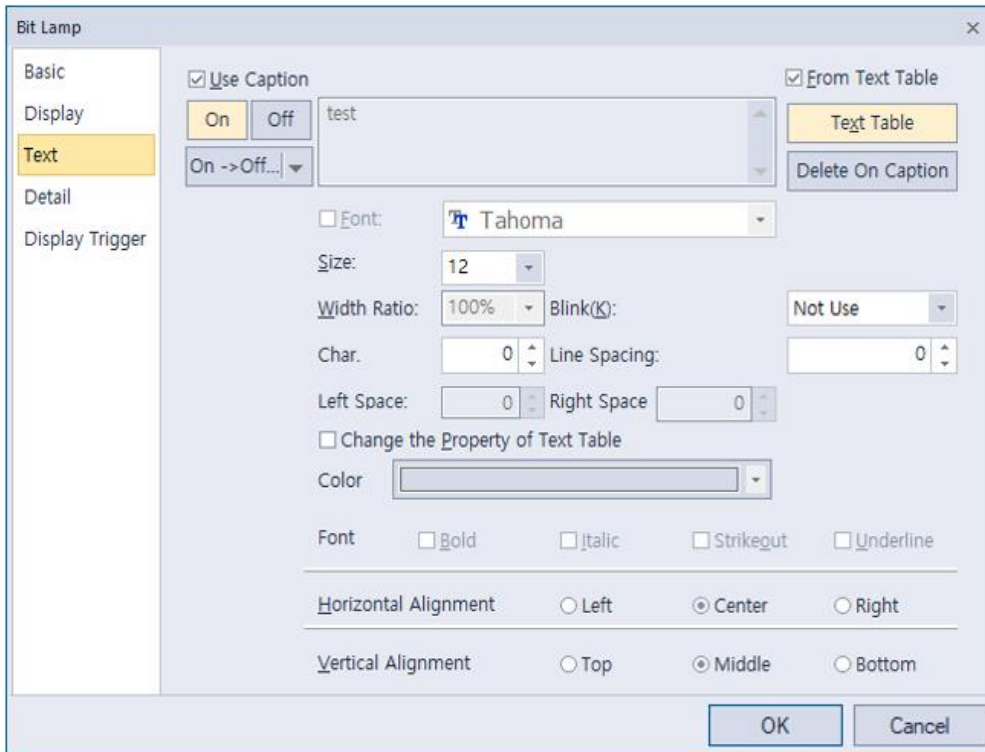

- **Use Caption:** Check the checkbox to use a text caption with the object. When you select this option, you can input text from a text table.
- **On:** Click to configure options for the object in the “On” state. You must input the text in a text table.
- **Off:** Click to configure options for the object in the “Off” state. You must input the text in a text table.
- **From Text Table:** Check the checkbox to add text from a text table. The Text Table option will be activated and the text input area will close. Add the required text to the text table before editing the object. You must select text for the “On” and “Off” states from the same text table.
- **Text Table:** Click to open the text table and select text. The color and font properties set in the text table will be imported with the text.

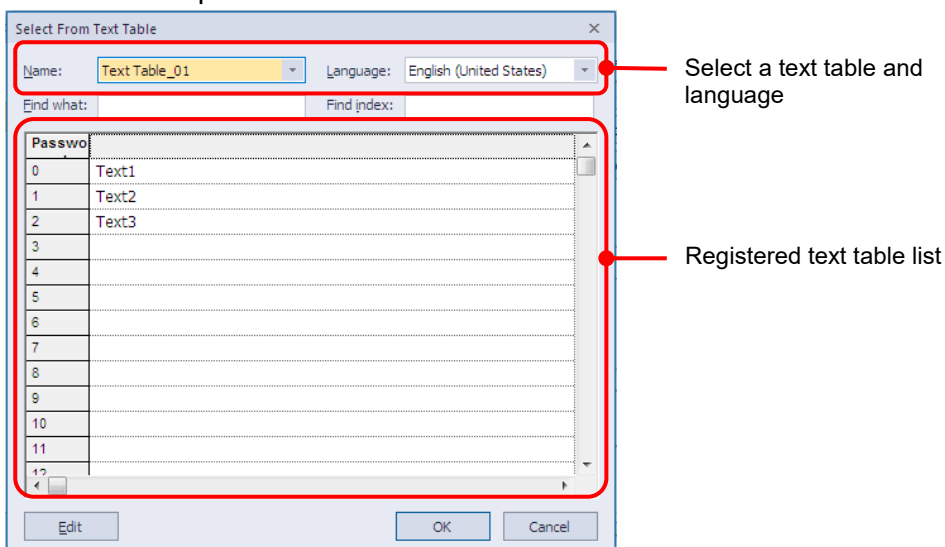

- **On <-> Off Copy:** Click to copy the text and formatting from the “on” state to the “off” state or vice versa.

- **Copy Only Caption:** You can open the dropdown menu next to [On -> Off] to select [Copy Only Caption]. This feature allows you to copy only the currently selected text string to another state.

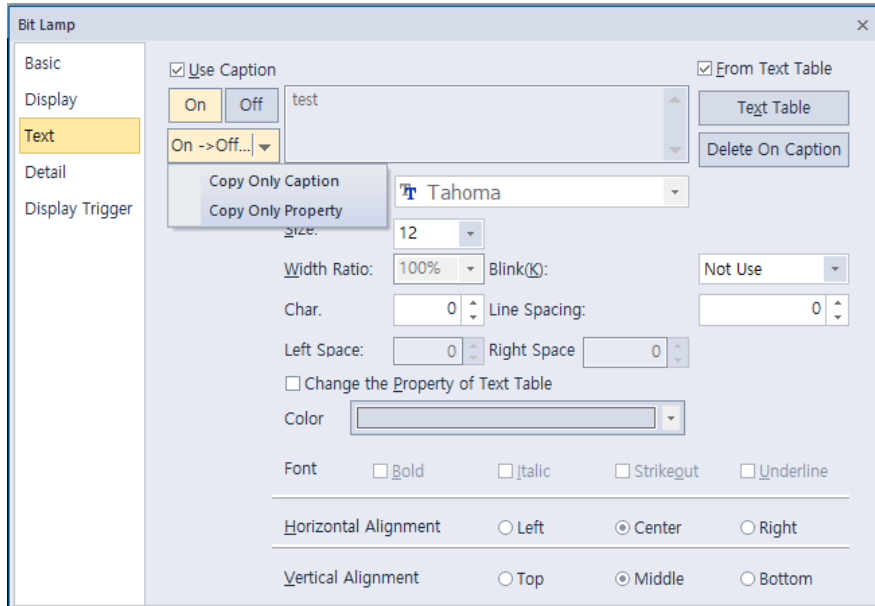

- **Copy Only Property:** You can open the dropdown menu next to [On -> Off] to select [Copy Only Property]. This feature allows you to copy all properties except the currently selected text string are copied to another state.
- **Delete On/Off Caption:** Click to clear text settings for the current state.
- **Font:** Select a font from the drop-down list.
- **Size:** Set a text size from the drop-down list or enter a value directly into the field.
- **Width Ratio:** Expand or condense the text by selecting a ratio from the drop-down list or entering a value directly in to the field. You can set a rate of 1%-600%.
- **Blink:** Set a blink speed for the caption.
XP30-BTE, XP30-TTE, XP40-TTE, and XP50-TTE are not supported.

Not use	The caption will not blink.
Slow	The caption will blink every three seconds.
Normal	The caption will blink every two seconds.
Fast	The caption will blink every second.

- **Space:** Set the space on the object. If you select Left align in Horizontal Alignment, you can set the left space, and if you select Right Align, you can set the right space.
- **Char. Spacing:** Set text intervals. If the value is a negative number, the spacing will decrease and if the value is a very small negative number, it can be overlaid or have the same effect as a positive number.
- **Line Spacing:** Set line spacing. If the value is a negative number, the spacing will decrease, and if the value is a very small negative number, it can be overlaid of have the same effect as a positive number.
- **Change the Property of Text Table:** Click to use different color and font properties for the text than what is specified in the text table. This option is active only when you fetch text from the text table.
- **Color:** Set a font color.

- **Font Style:** Set a font style (bold, italic, strikethrough, or underline). You can apply more than one option at a time.
 - **Horizontal Alignment:** Set the horizontal alignment (Left, Center, or Right).
 - **Vertical Alignment:** Set the vertical alignment (Top, Middle, or Bottom).
- **Detail:** The detail settings for bit lamp objects include the following.

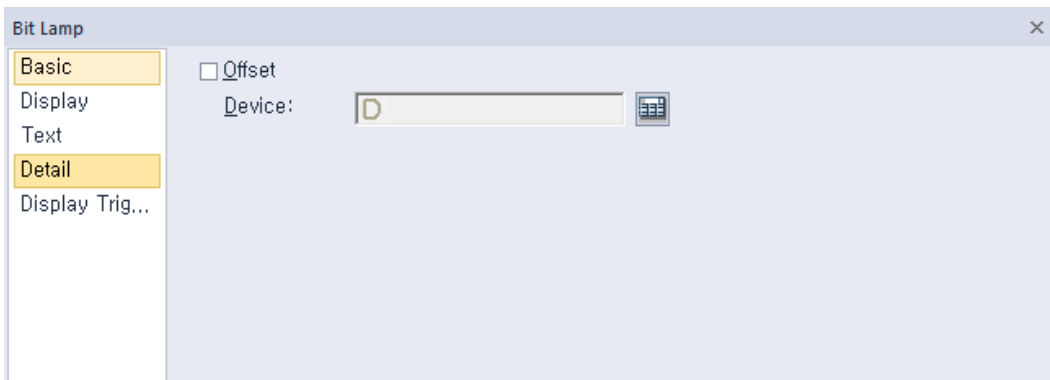

- **Offset:** Click the checkbox to use the Offset function. You can offset the device address based on the value of the offset device. For example, if the starting device address is P100, XP-Builder reads the value from the offset device and offsets the address by that value. If the offset value is 10, for example, then the referenced device address is P110.
- **Device:** Enter a device or tag address directly into the input field or click the keypad icon to the right to specify a device or tag address. When you click the keypad icon to open the Device window you can also specify network settings, if necessary.

- **Display Trigger:** The display trigger setting for bit lamp objects.

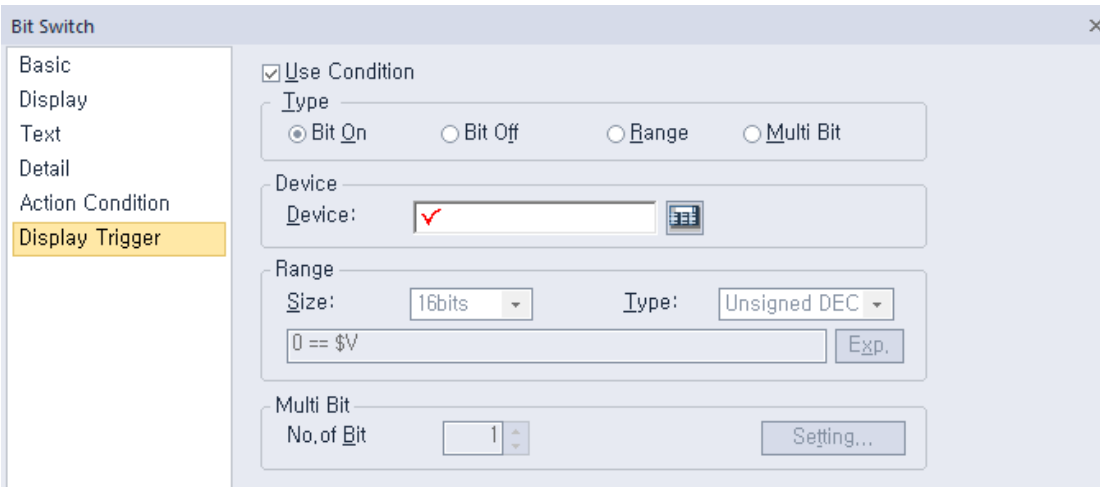

- **Use Condition:** Set whether or not to specify a condition for the display trigger.
- **Type:** Select the type of condition to be set.

Bit On	The object will display when the device is on.
Bit Off	The object will display when the device is off.
Range	The object will display when the range condition of the device is satisfied.
Multi Bit	The object will display when the logical operation results of multiple device are satisfied.

- **Device:** Enter a device or tag address directly into the input field or click the keypad icon to the right to specify a device or tag address. When you click the keypad icon to open the Device window you can also specify network settings, if necessary.
- **Range:** Sets the range condition when you select it.

Size	16bit or 32bit.
Type	Signed DEC, Unsigned DEC, BCD, or float.
Expression	Click to designate the expression as conditional.

- **Multi Bit:** If you select the multi bit condition, specify the number of bits and click [Setting] to specify the bit conditions.

4.3.1.2 Word Lamp

The form of a word lamp changes based on the text value of the connected device. This section describes available settings for word lamp objects.

Below is an example of how to create and set a word lamp.

- 1 Insert a word lamp on the screen.
- 2 Double-click the word lamp to open the properties window.
- 3 Set the device to IW0.0.2 from the Basic setting.
- 4 Create four conditional expressions from the Basic setting. (\$V is a standard device.)

\$V == 1
 \$V == 2
 \$V == 3
 \$V == 4

- 5 Set the images for conditions 1 to 4 in the Display setting.
- 6 Set the text for conditions 1 to 4 in the Text setting.

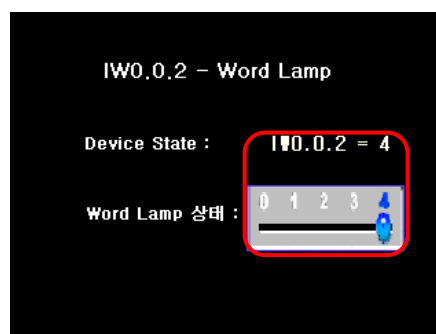
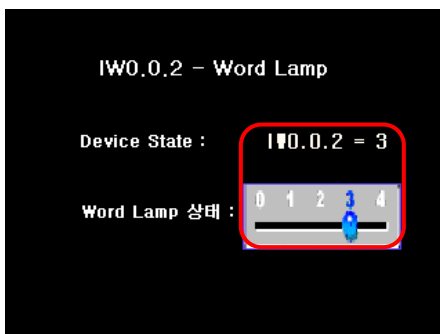
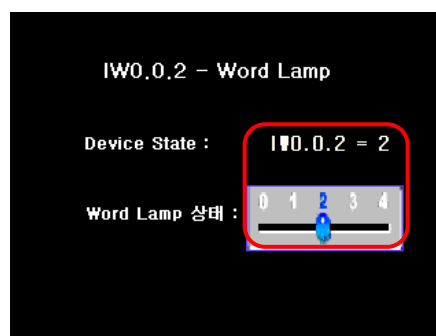
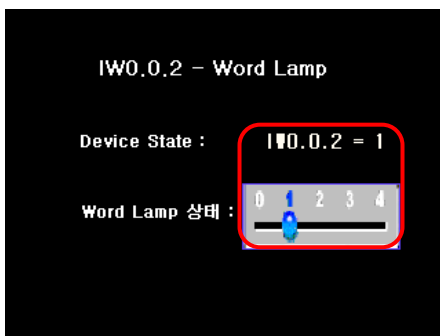

- **Basic:** The basic settings for word lamp objects include the following.

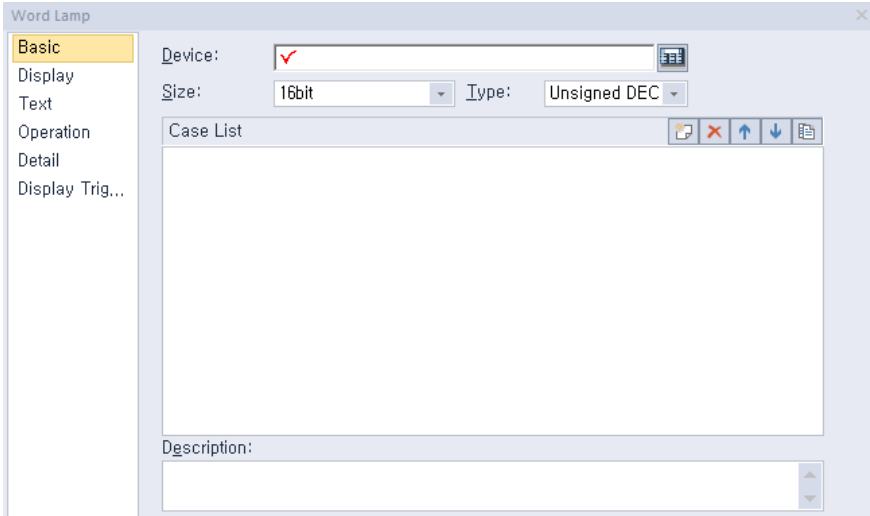

- **Device:** Enter a device or tag address directly into the input field or click the keypad icon to the right to specify a device or tag address. When you click the keypad icon to open the Device window, you can also specify network settings, if necessary.
- **Size:** Set the data size for the device (16 bit upper byte, 16 bit lower byte, 16 bit, or 32 bit).
- **Type:** Set the data type for the device (signed decimal, unsigned decimal, BCD, or float).
- **Case List:** Create, delete, or reorganize conditional expressions:

	(Create)	Click to create a new range condition. You can create up to eight conditions. Clicking this button opens the Range Edit window, which allows you to create a condition. For more information, refer to <4.2.1.3 Understanding Constants and Data Types> .
	(Delete)	Click a condition and then click this icon to delete the condition.
	(Up)	Click a condition and then click this icon to move it higher up the list.
	(Down)	Click a condition and then click this icon to move it lower down the list.
	(Copy&Paste)	Select the conditional statement and click the corresponding button to add a new conditional statement. However, new conditional statements are not added if the number of conditional statements reach 64.

- **Description:** Enter a description for the object.

- **Display:** The display settings for word lamp objects include the following.

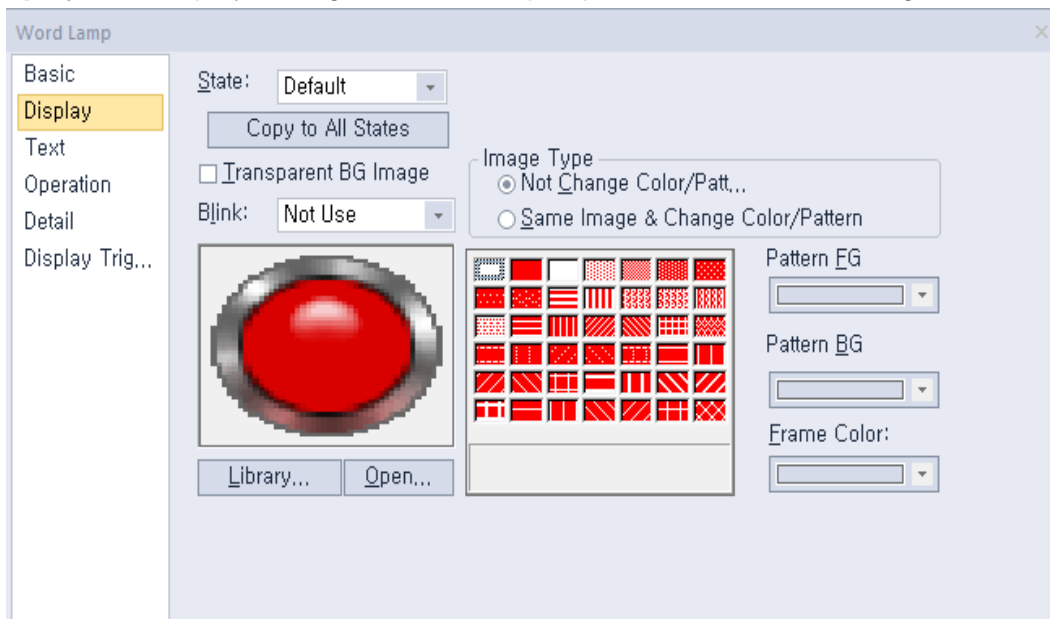

- **Transparent BG Image:** Click the checkbox to make the image background transparent. You cannot use a transparent background and the reverse image setting at the same time.
- **State:** Select a state from the drop-down list to configure options for each state.
- **Blink:** Set a blink speed for the object:
XP30-BTE, XP30-TTE, XP40-TTE, and XP50-TTE are not supported.

Not use	The object will not blink.
Slow	The object will blink every three seconds.
Normal	The object will blink every two seconds.
Fast	The object will blink every second.

- **Image Type:** Set whether or not to change colors and patterns when switching between “On” and “Off” states. If you select the Change Color/Pattern option, you must select a vector image for the object. To view characteristics of raster or vector images, refer to **<2.4.1 Managing Graphic Libraries>**.

Not Change Color/Pattern	Use the original image. You can apply the pattern or color to the image. Select the image to display for On or Off status from raster, vector, or user-registered images.
Same Image & Change Color/Pattern in On/Off	Select a vector image. You cannot select a raster image. Apply a pattern or color to the image.

- **Library:** Click to select an image from the library.
- **Open:** Click to browse for images on your computer. When you select an image from your computer, it will be added to the image library automatically.
- **Pattern:** Click a pattern to apply to the image. This option is available only when you select the change color or pattern option in **Image Type**. Patterns are applied to specific parts of objects, but not to the frames. The frames are different for each image. Refer the following examples:

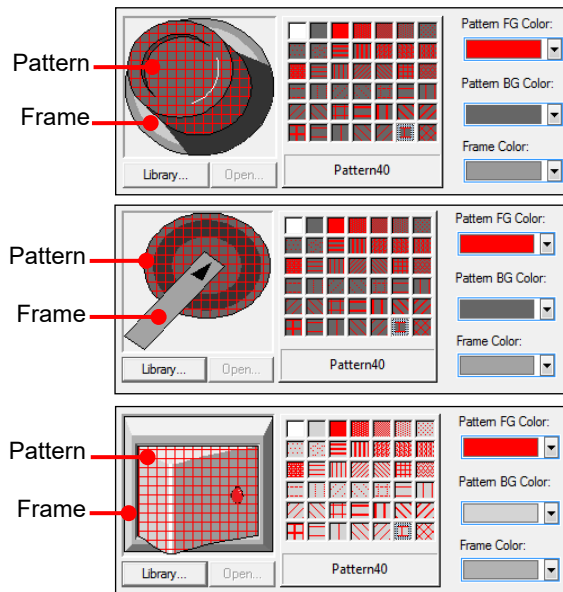

- **Pattern FG Color:** Set a color for the foreground pattern.
- **Pattern BG Color:** Set a color for the background pattern.
- **Frame Color:** Set a frame color.

- **Text:** The text settings for word lamp objects include the following.

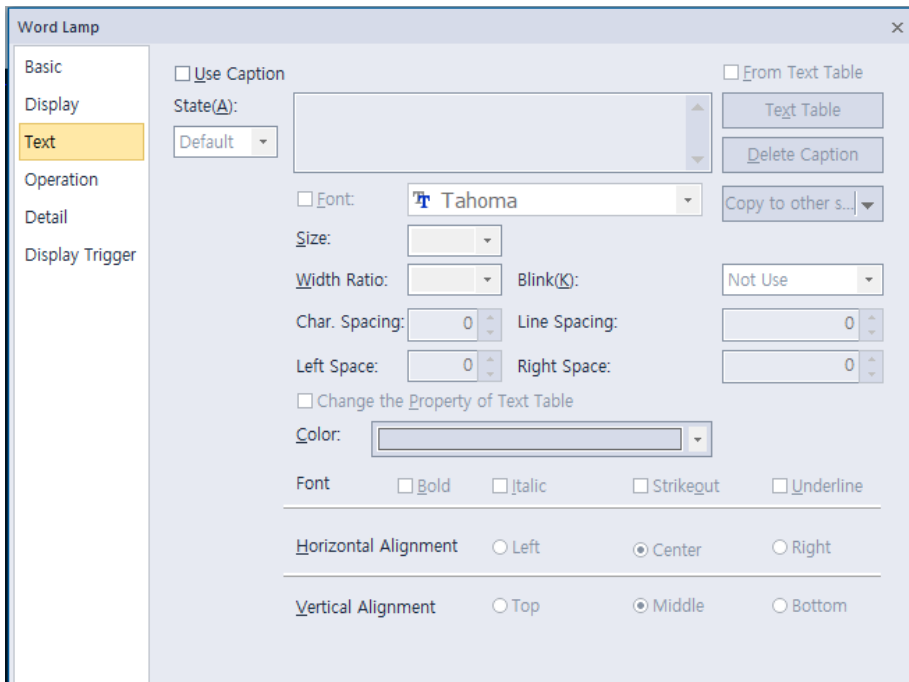

- **Use Caption:** Click the checkbox to use a text caption with the object. When you select this option, you can input text from a Text Table.
- **On:** Click to configure options for the object in the “On” state. You must input the text in a text table.
- **Off:** Click to configure options for the object in the “Off” state. You must input the text in a text table.
- **From Text Table:** Click the checkbox to add text from a text table. The Text Table option will be activated and the text input area will close. Add the required text to the text table before editing the object. You must select text for the “On” and “Off” states from the same text table.
- **Text Table:** Click to open the text table and select text. The color and font properties set in the text table will be imported with the text.

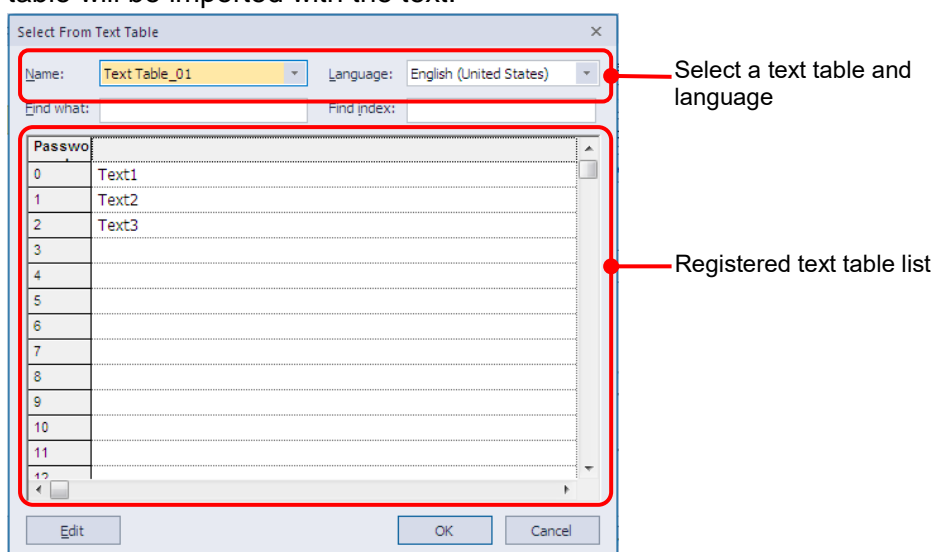

- **Copy to other state:** Click to copy the text string and the text style of the current state to all other states.

- **Copy Only Caption:** You can open the dropdown menu next to [Copy to other state] to select [Copy Only Caption]. This feature allows you to copy only the currently selected text string to other states.

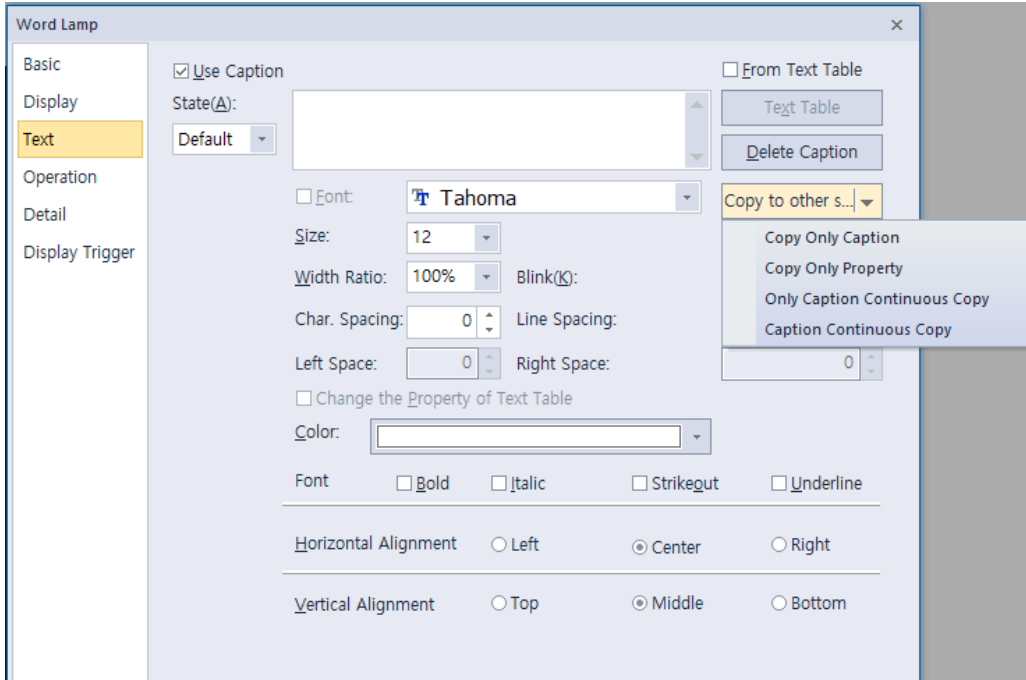

- **Copy only property:** You can set [Copy only property]. In this case, all properties except the currently set string are copied to another state.
- **Only caption continuous copy:** Captions are copied consecutively to different states based on the current state caption.

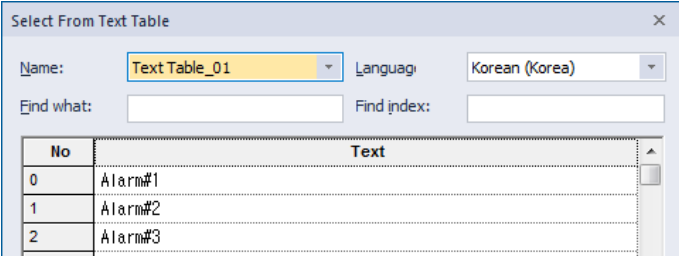
<p>If you input directly.</p>	<p>Add the numbers entered directly behind captions to automatically copy to another state. For example, if the caption is set to [Control 1] in the state 1, the caption 0 is automatically set to [Control 0] and the caption 2 is set to [Control 2].</p>
<p>If selected as a text table</p>	<p>The index of the text table is automatically incremented by one. For example, if the caption of state 0 is as follows ([0] is stopped), state 1 caption is automatically set to ([1] in standby), and state 2 caption is automatically set to ([2] start).</p> 
<p>Slow</p>	<p>The caption will blink every three seconds.</p>
<p>Normal</p>	<p>The caption will blink every two seconds.</p>
<p>Fast</p>	<p>The caption will blink every second.</p>

- **Caption Continuous Copy:** Captions are copied continuously by the above method, and the set property information (alignment, font, size, etc.) is also copied together.
- **Delete Caption:** Click to clear text settings for the current state.
- **Font:** Select a font from the drop-down list.
- **Size:** Set a text size from the drop-down list or enter a value directly into the field.
- **Width Ratio:** Expand or condense the text by selecting a ratio from the drop-down list or entering a value directly in to the field. You can set a rate of 1%-600%.
- **Blink:** Set the blink speed for the caption.
XP30-BTE, XP30-TTE, XP40-TTE, and XP50-TTE are not supported.

Not use	The caption will not blink.
Slow	The caption will blink every three seconds.
Normal	The caption will blink every two seconds.
Fast	The caption will blink every second.

- **Space:** Set the space on the object. If you select Left align in Horizontal Alignment, you can set the left space, and if you select Right Align, you can set the right space.
- **Char. Spacing:** Set text intervals. If the value is a negative number, the spacing will decrease and if the value is a very small negative number, it can be overlaid or have the same effect as a positive number.
- **Line Spacing:** Set line spacing. If the value is a negative number, the spacing will decrease, and if the value is a very small negative number, it can be overlaid of have the same effect as a positive number.
- **Change the Property of Text Table:** Click to use different color and font properties for the text than what is specified in the text table. This option is active only when you fetch text from the text table.
- **Color:** Set a font color.
- **Font Style:** Set a font style (bold, italic, strikeout, or underline). You can apply more than one option at a time.
- **Horizontal Alignment:** Set the horizontal alignment (Left, Center, or Right).
- **Vertical Alignment:** Set the vertical alignment (Top, Middle, or Bottom).

- **Operation:** Operation settings for word lamp objects include the following.

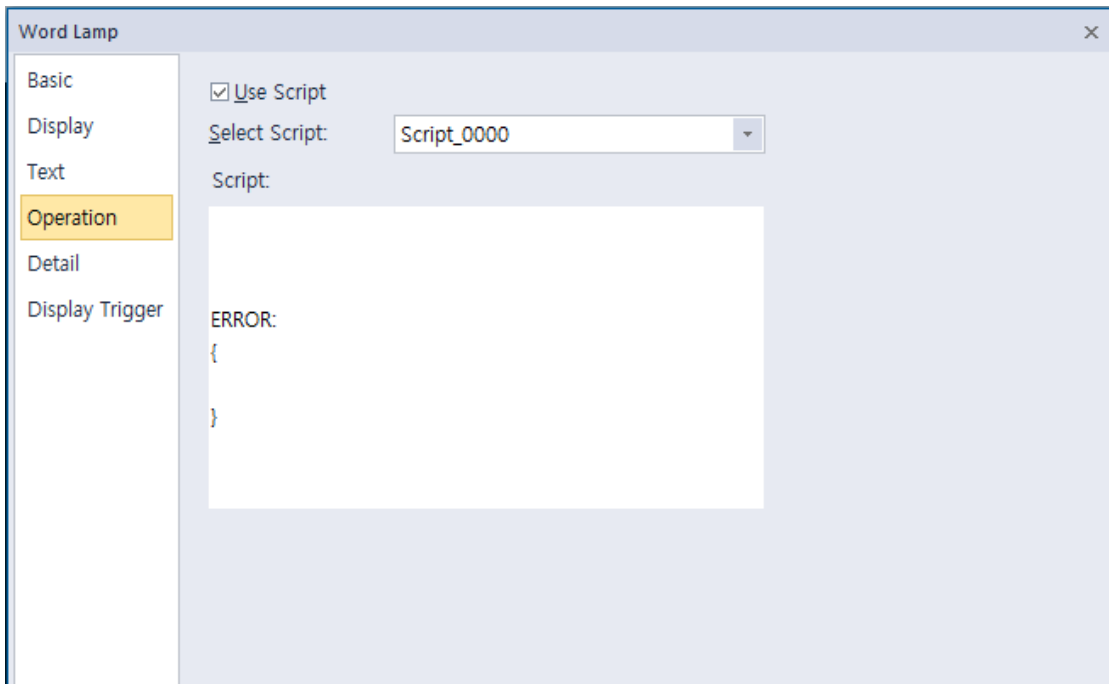

- **Use Script:** Check the checkbox to use a script with the object.
- **Select Script:** Select a script from the drop-down list.
- **Script:** When you select a script, it appears here. To modify a script, refer to **<4.2 Scripts>**.

- **Detail:** The detail settings for word lamp objects include the following.

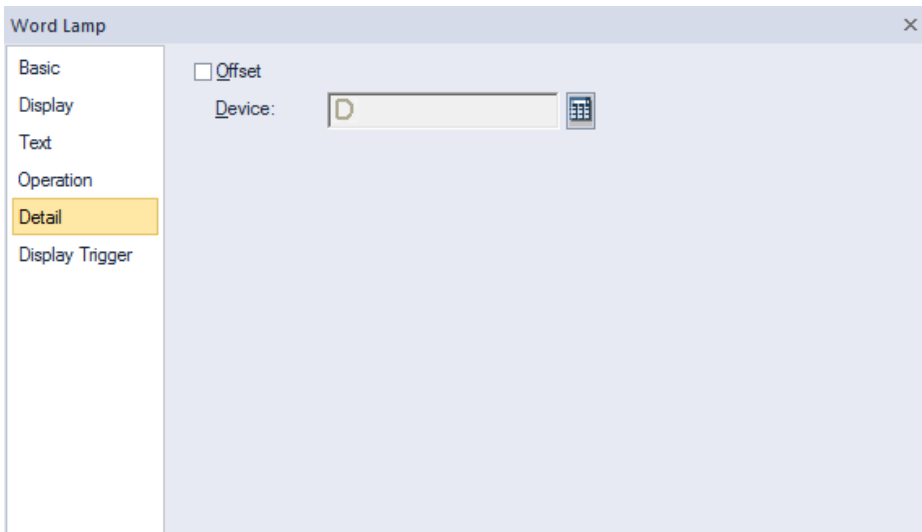

- **Offset:** Check the checkbox to use the Offset function. You can offset the device address based on the value of the offset device. For example, if the starting device address is P100, XP-Builder reads the value from the offset device and offsets the address by that value. If the offset value is 10, for example, then the referenced device address is P110.
- **Device:** Enter a device or tag address directly into the input field or click the keypad icon to the right to specify a device or tag address. When you click the keypad icon to open the Device window, you can also specify network settings, if necessary.

- **Display Trigger:** The display trigger setting for word lamp objects.

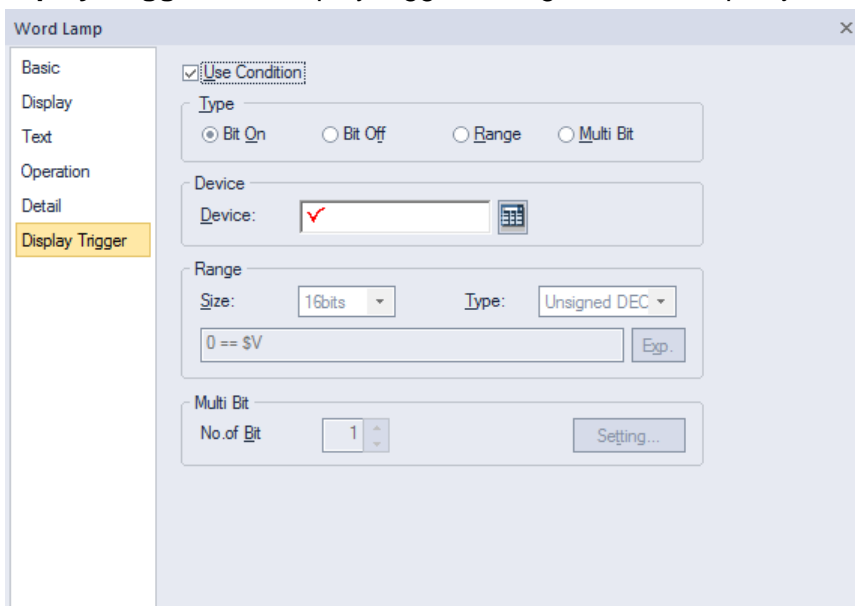

- **Use Condition:** Set whether or not to specify a condition for the display trigger.
- **Type:** Select the type of condition to be set.

Bit On	The object will display when the device is on.
Bit Off	The object will display when the device is off.
Range	The object will display when the range condition of the device is

	satisfied.
Multi Bit	The object will display when the logical operation results of multiple device are satisfied.

- **Device:** Enter a device or tag address directly into the input field or click the keypad icon to the right to specify a device or tag address. When you click the keypad icon to open the device window you can also specify network settings, if necessary.
- **Range:** Sets the range condition when you select it.

Size	16bit or 32bit.
Type	Signed DEC, Unsigned DEC, BCD, or float.
Expression	Click to designate the expression as conditional

- **Multi Bit:** If you select the multi bit condition, specify the number of bits and click [Setting] to the bit condition.

4.3.1.3 N-State Lamp

This section describes available settings for N-State lamp objects. The form of an N-State lamp changes based on the statuses of up to 16 controllers. Refer to the following examples:

- Monitoring device (Bit device): P0000, M0000

Priority	Status No.	Bit Device Status	Image Color	Displayed Text	Flashing Speed
High 	Status 0	P0000: OFF M0000: OFF	Blue	Normal operation	No flashing
	Status 1	P0000: ON M0000: OFF	Red	Stop	Fast
	Status 2	P0000: OFF M0000: ON	Yellow	Caution	Slow
Low	Status 3	P0000: ON M0000: ON	Purple	Alarm	Normal



P0000: OFF / M0000: OFF



P0000: ON / M0000: OFF



P0000: OFF / M0000: ON







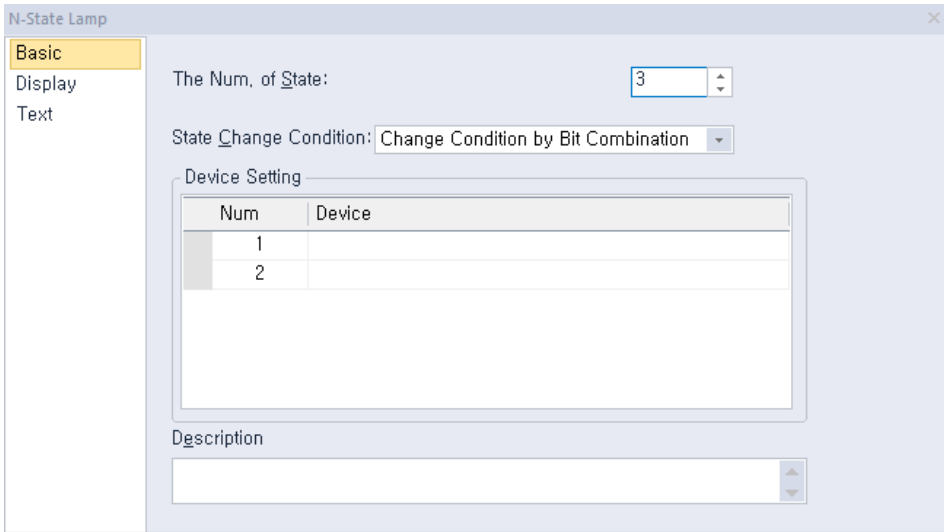

























P0000: ON / M0000: ON

- **Basic:** The basic settings for N-State lamp objects include the following.



- **The Num. of State:** Select the number of statuses to display for the object (from 3 to 16).
- **State Change Condition:** Set a method for changing device statuses.

Change Condition by Bit	<p>Display the On/Off status for up to four controllers with one lamp. The maximum number of statuses is five. Refer to the following example:</p> <table border="1" style="width: 100%; text-align: center;"> <thead> <tr style="background-color: #cccccc;"> <th>Type</th> <th>P0</th> <th>P1</th> <th>P2</th> <th>P3</th> <th>Display example</th> </tr> </thead> <tbody> <tr> <td>Status 1</td> <td>OFF</td> <td>OFF</td> <td>OFF</td> <td>OFF</td> <td></td> </tr> <tr> <td>Status 2</td> <td>ON</td> <td>OFF</td> <td>OFF</td> <td>OFF</td> <td></td> </tr> <tr> <td>Status 3</td> <td>OFF</td> <td>ON</td> <td>OFF</td> <td>OFF</td> <td></td> </tr> <tr> <td>Status 4</td> <td>OFF</td> <td>OFF</td> <td>ON</td> <td>OFF</td> <td></td> </tr> <tr> <td>Status 5</td> <td>OFF</td> <td>OFF</td> <td>OFF</td> <td>ON</td> <td></td> </tr> </tbody> </table>	Type	P0	P1	P2	P3	Display example	Status 1	OFF	OFF	OFF	OFF		Status 2	ON	OFF	OFF	OFF		Status 3	OFF	ON	OFF	OFF		Status 4	OFF	OFF	ON	OFF		Status 5	OFF	OFF	OFF	ON	
Type	P0	P1	P2	P3	Display example																																
Status 1	OFF	OFF	OFF	OFF																																	
Status 2	ON	OFF	OFF	OFF																																	
Status 3	OFF	ON	OFF	OFF																																	
Status 4	OFF	OFF	ON	OFF																																	
Status 5	OFF	OFF	OFF	ON																																	
Change Condition by Bit Combination	<p>Displays the combined On/Off status for up to four controllers with one lamp. The maximum number of statuses is 16. Refer to the following example:</p> <table border="1" style="width: 100%; text-align: center;"> <thead> <tr style="background-color: #cccccc;"> <th>Type</th> <th>P0</th> <th>P1</th> <th>P2</th> <th>P3</th> <th>Display example</th> </tr> </thead> <tbody> <tr> <td>Status 1</td> <td>OFF</td> <td>OFF</td> <td>OFF</td> <td>OFF</td> <td></td> </tr> <tr> <td>Status 2</td> <td>ON</td> <td>OFF</td> <td>OFF</td> <td>OFF</td> <td></td> </tr> <tr> <td>Status 3</td> <td>OFF</td> <td>ON</td> <td>OFF</td> <td>OFF</td> <td></td> </tr> <tr> <td>Status 4</td> <td>ON</td> <td>ON</td> <td>OFF</td> <td>OFF</td> <td></td> </tr> <tr> <td>Status 5</td> <td>OFF</td> <td>OFF</td> <td>ON</td> <td>OFF</td> <td></td> </tr> </tbody> </table>	Type	P0	P1	P2	P3	Display example	Status 1	OFF	OFF	OFF	OFF		Status 2	ON	OFF	OFF	OFF		Status 3	OFF	ON	OFF	OFF		Status 4	ON	ON	OFF	OFF		Status 5	OFF	OFF	ON	OFF	
Type	P0	P1	P2	P3	Display example																																
Status 1	OFF	OFF	OFF	OFF																																	
Status 2	ON	OFF	OFF	OFF																																	
Status 3	OFF	ON	OFF	OFF																																	
Status 4	ON	ON	OFF	OFF																																	
Status 5	OFF	OFF	ON	OFF																																	

- **Device Setting:** Enter a device or tag address directly into the input field or click the keypad icon to the right to specify a device or tag address. When you click the keypad icon to open the Device window, you can also specify network settings, if necessary.
- **Description:** Enter a description for the object.

- **Display:** The display settings for word lamp objects include the following.

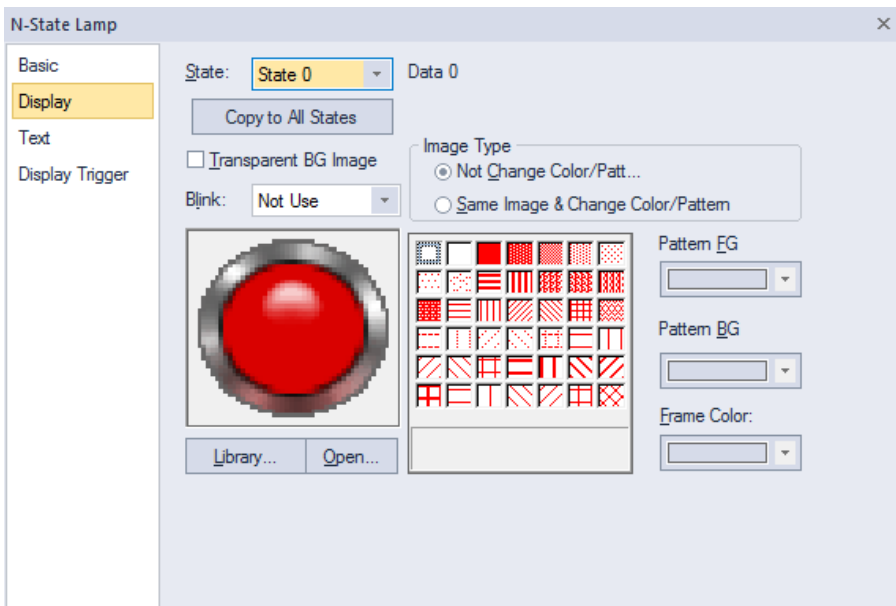

- **Transparent BG Image:** Click the checkbox to make the image background transparent.
- **State:** Select a state from the drop-down list to configure options for each state.
- **Blink:** Set a blink speed for the object:

Not use	The object will not blink.
Slow	The object will blink every three seconds.
Normal	The object will blink every two seconds.
Fast	The object will blink every second.

- **Image Type:** Set whether or not to change colors and patterns when switching between “On” and “Off” states. If you select the change color or pattern option, you must select a vector image for the object. To view characteristics of raster or vector images, refer to [<2.4.1 Managing Graphic Libraries>](#).

Not Change Color/Pattern	Use the original image. You can apply the pattern or color to the image. Select the image to display for On or Off status from raster, vector, or user registered images.
Same Image & Change Color/Pattern in On/Off	Select a vector image. You cannot select a raster image. Apply a pattern or color to the image.

- **Library:** Click to select an image from the library.
- **Open:** Click to browse for images on your computer. When you select an image from your computer, it will be added to the image library automatically.
- **Pattern:** Click a pattern to apply to the image. This option is available only when you select the change color or pattern option in **Image Type**. Patterns are applied to specific parts of objects, but not to the frames. The frames are different for each image. Refer the following examples:

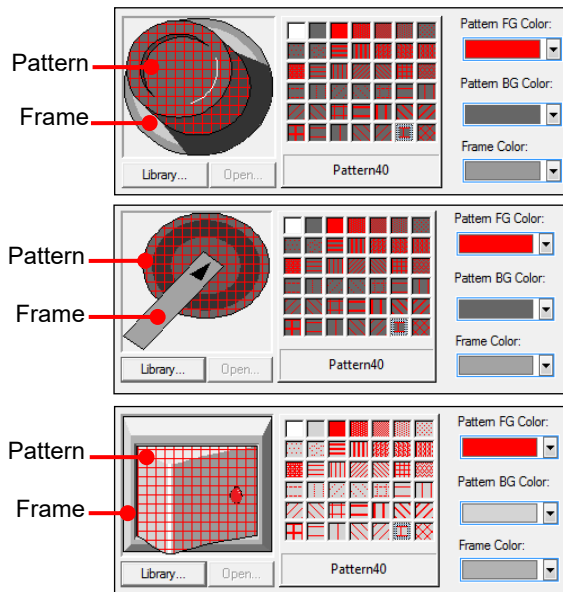

- **Pattern FG Color:** Set a color for the foreground pattern.
- **Pattern BG Color:** Set a color for the background pattern.
- **Frame Color:** Set a frame color.

• **Text Settings:** The text settings for word lamp objects include the following.

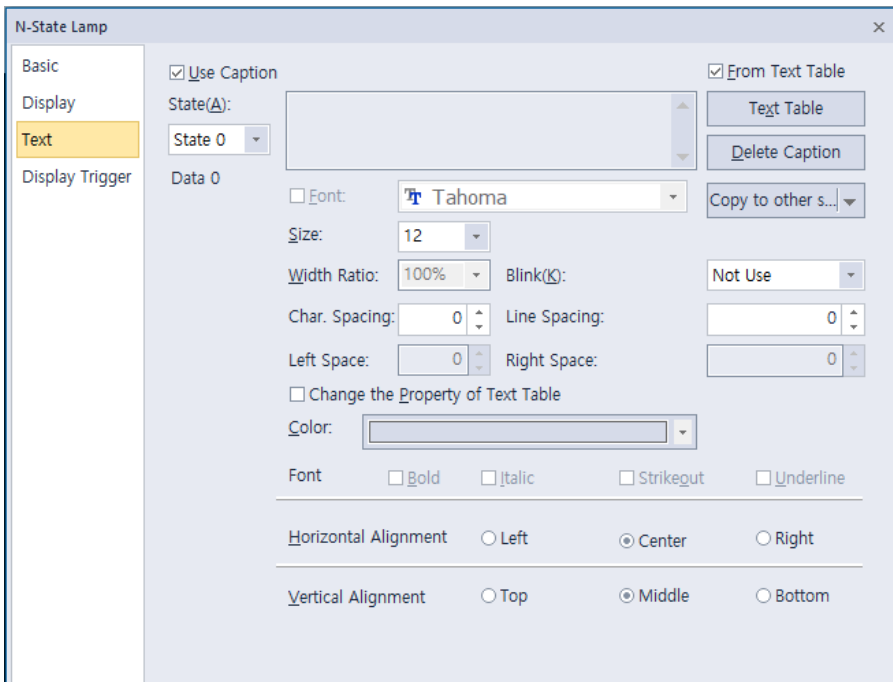

- **Use Caption:** Check the checkbox to use a text caption with the object. When you select this option, you can input text from a Text Table.
- **On:** Click to configure options for the object in the “On” state. You must input the text in a text table.
- **Off:** Click to configure options for the object in the “Off” state. You must input the text in a text table.
- **From Text Table:** Check the checkbox to add text from a text table. The Text Table option will be activated and the text input area will close. Add the required text to the text table before editing the object. You must select text for each state from the same text table.

- **Text Table:** Click to open the text table and select text. The color and font properties set in the text table will be imported with the text.

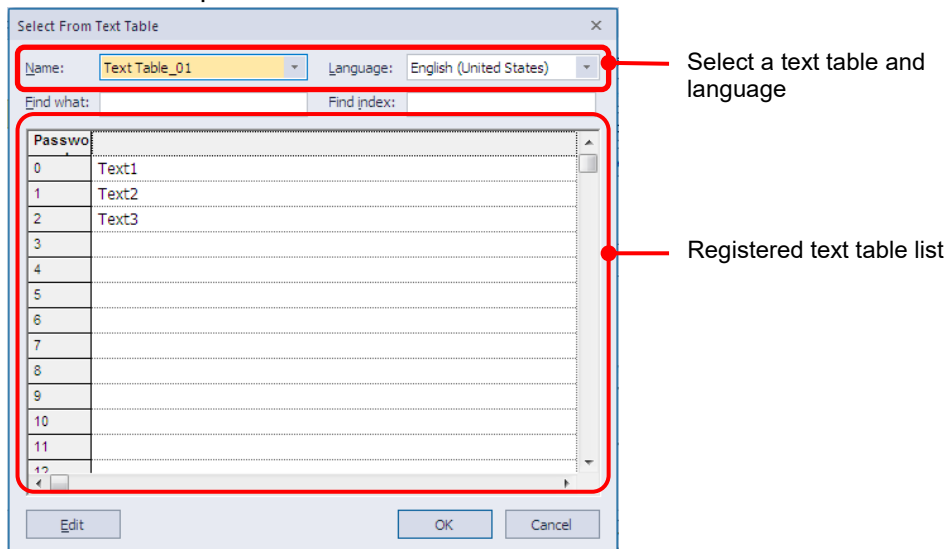

- **Delete Caption:** Click to clear text settings for the current state.
- **Copy to other state:** Click to copy the current caption to another state's caption properties.
- **Copy Only Caption:** You can open the dropdown menu next to [Copy to other state] to select [Copy Only Caption]. This feature allows you to copy only the currently selected text string to another state.
- **Copy Only Caption:** You can open the dropdown menu next to [Copy to other state] to select [Copy Only Caption]. This feature allows you to copy only the currently selected text string to another state.

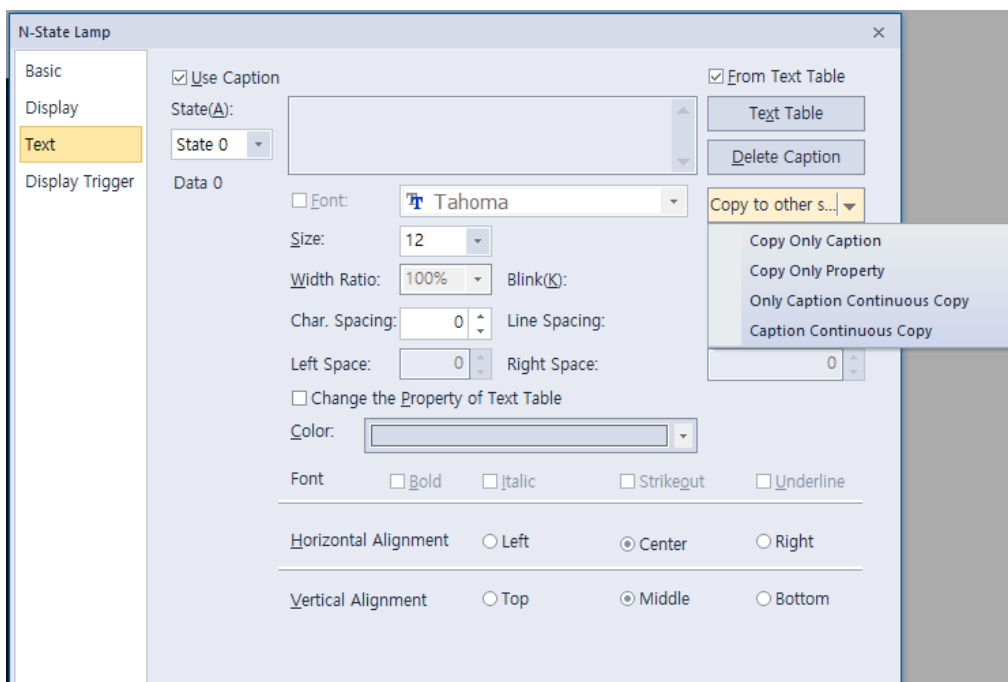

- **Copy only property:** You can set [Copy only property]. In this case, all properties except the currently set string are copied to another state.

- **Only caption continuous copy:** Captions are copied consecutively to different states based on the current state caption.

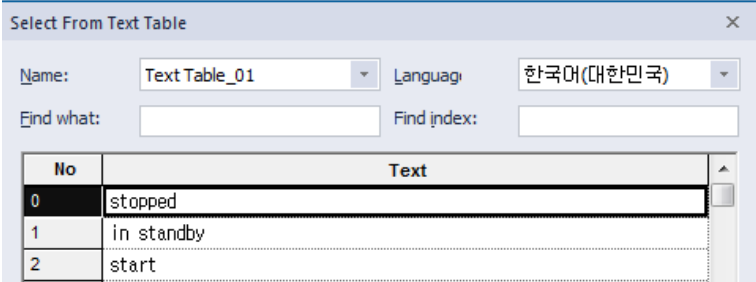
If you input directly.	Add the numbers entered directly behind captions to automatically copy to another state. For example, if the caption is set to [Control 1] in the state 1, the caption 0 is automatically set to [Control 0] and the caption 2 is set to [Control 2].
If selected as a text table	The index of the text table is automatically incremented by one. For example, if the caption of state 0 is as follows ([0] is stopped), state 1 caption is automatically set to ([1] in standby), and state 2 caption is automatically set to ([2] start). 
Slow	The caption will blink every three seconds.
Normal	The caption will blink every two seconds.
Fast	The caption will blink every second.

- **Caption Continuous Copy:** Captions are copied continuously by the above method, and the set property information (alignment, font, size, etc.) is also copied together.
- **Font:** Select a font from the drop-down list.
- **Size:** Set a text size from the drop-down list or enter a value directly into the field.
- **Width Ratio:** Expand or condense the text by selecting a ratio from the drop-down list or entering a value directly in to the field. You can set a rate of 1%-600%.
- **Blink:** Set the blink speed for the caption.
XP30-BTE, XP30-TTE, XP40-TTE, and XP50-TTE are not supported

Not use	The caption will not blink.
Slow	The caption will blink every three seconds.
Normal	The caption will blink every two seconds.
Fast	The caption will blink every second.

- **Space:** Set the space on the object. If you select Left align in Horizontal Alignment, you can set the left space, and if you select Right Align, you can set the right space.
- **Char. Spacing:** Set text intervals. If the value is a negative number, the spacing will decrease and if the value is a very small negative number, it can be overlaid or have the same effect as a positive number.
- **Line. Spacing:** Set line spacing. If the value is a negative number, the spacing will decrease, and if the value is a very small negative number, it can be overlaid of have the same effect as a positive number.

- **Change the Property of Text Table:** Click to use different color and font properties for the text than what is specified in the text table. This option is active only when you fetch text from the text table.
 - **Color:** Set a font color.
 - **Font Style:** Set a font style (bold, italic, strikeout, or underline). You can apply more than one option at a time.
 - **Horizontal Alignment:** Set the horizontal alignment (Left, Center, or Right).
 - **Vertical Alignment:** Set the vertical alignment (Top, Middle, or Bottom).
- **Display Trigger:** The display trigger setting for word lamp objects.

- **Use Condition:** Set whether or not to specify a condition for the display trigger.
- **Type:** Select the type of condition to be set.

Bit On	The object will display when the device is on.
Bit Off	The object will display when the device is off.
Range	The object will display when the range condition of the device is satisfied.
Multi Bit	The object will display when the logical operation results of multiple device are satisfied.

- **Device:** Enter a device or tag address directly into the input field or click the keypad icon to the right to specify a device or tag address. When you click the keypad icon to open the Device window you can also specify network settings, if necessary.
- **Range:** Sets the range condition when you select it.

Size	16bit or 32bit.
Type	Signed DEC, Unsigned DEC, BCD, or float.
Expression	Click to designate the expression as conditional.

- **Multi Bit:** If you select the multi bit condition, specify the number of bits and click [Setting] to specify the bit conditions.

4.3.2 Switch Objects

Switches execute one or more functions, based on the switch type. Five switch types are available: Bit, Word, Change screen, Special, and Multi. Bit switches control On/Off states, Word switches execute scripts or change values, Change screen switches change screens in the XGT Panel interface. Special switches perform storage-related actions. Multi switches carry out multiple functions.

Note

- If the switch is not connected to PLC device when using lamp condition, it is not displayed on XGT Panel.
- The lamp displays the default image if the connection with PLC device fails before 1 scan is completed.
 - ※ For details, refer to **<Appendix 5. Object Display Rule before Communication Connection>**.

4.3.2.1 Bit Switch

Bit switches control On/Off states of bit devices. This section describes available settings for bit switch objects.

- **Basic:** The basic settings for bit switches include the following.

- **Device:** Enter a device or tag address directly into the input field or click the keypad icon to the right to specify a device or tag address. When you click the keypad icon to open the Device window, you can also specify network settings, if necessary.
- **Copy to Lamp:** Click to copy the device address from a bit switch to a lamp condition address.
- **Action Type:** Set an operation to perform when the switch is activated.

On	Turns on the relevant bit device in the PLC when the switch is activated. The state is preserved until changed by another action.
-----------	---

Off	Turns off the relevant bit device in the PLC when the switch is activated. The state is preserved until changed by another action.
Momentary	Turns on the relevant bit device in the PLC only while the switch object is held. The state returns to "Off" when the switch is released.
Alternative	Switches the relevant bit device value to the opposite state when the switch is activated. If the object is on when the switch is activated, it will turn off and vice versa.

- **Use Lamp Condition:** If you want to control a lamp with a method other than simply turning it on when the switch is activated, you can select a different action.

Bit Device	When the device state is "On", the lamp is on.
Copy to Main	The lamp condition's bit device address is copied to the basic device of a bit switch.
Word Device	When the condition is met, the lamp is on.
Size	16 bit upper byte, 16 bit lower byte, 16 bit, or 32 bit.
Type	Signed decimal, unsigned decimal, BCD, or float.
Exp.	Click to designate the expression as conditional.

- **Use Lamp Offset:** Click to set an offset for the lamp.
- **Description:** Enter a description for the object.

- **Display:** The display settings for bit switch objects include the following.

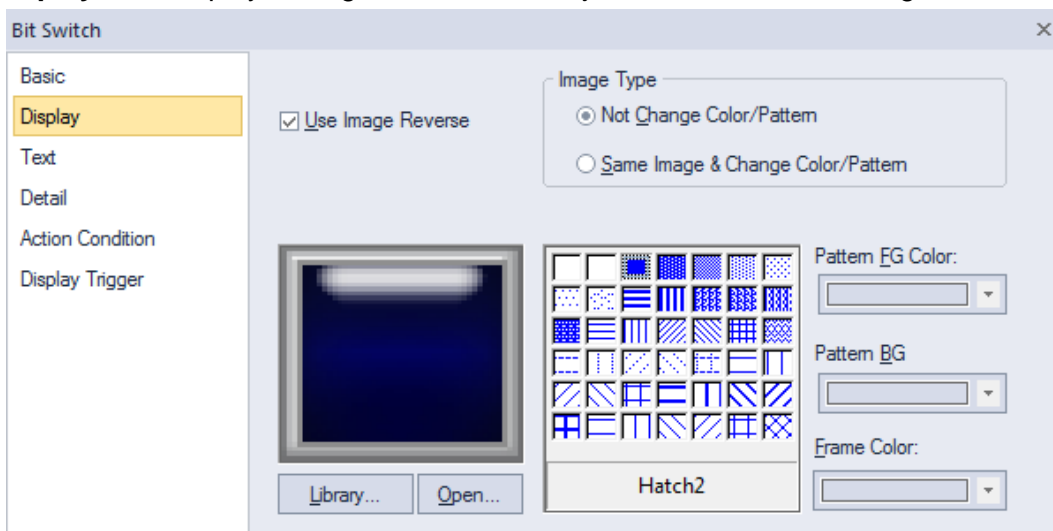

- **Transparent BG Image:** Check the checkbox to make the image background transparent. You cannot use a transparent background and the reverse image setting at the same time.
- **Use Image Reverse:** The switch image is reversed when you tap the object or a condition is met. If you set this option, you cannot use the **Transparent BG Image** option or the On/Off image. If you set the **Transparent BG Image** option, you cannot use this option.
- **On:** Click to configure options for the object in the "On" state.
- **Off:** Click to configure options for the object in the "Off" state.

- **Off->On Copy:** Copies all image properties in the Off state to On.
- **On->Off Copy:** Copies all image properties in On status to Off.
- **Image Type:** Set whether or not to change colors and patterns when switching between “On” and “Off” states. If you select the change color or pattern option, you must select a vector image for the object. To view characteristics of raster or vector images refer to **<2.4.1 Managing Graphic Libraries>**.

Not Change Color/Pattern	Use the original image. You can apply the pattern or color to the image. Select the image to display for On/Off status from raster, vector, or user registered images.
Same Image & Change Color/Pattern in On/Off	Select a vector image. You cannot select a raster image. Apply a pattern or color to the image.

- **Library:** Click to select an image from the library.
- **Open:** Click to browse for images on your computer. When you select an image from your computer, it will be added to the image library automatically.
- **Pattern:** Click a pattern to apply to the image. This option is available only when you select the Change color or Pattern option in **Image Type**. Patterns are applied to specific parts of objects, but not to the frames. The frames are different for each image. Refer the following examples:

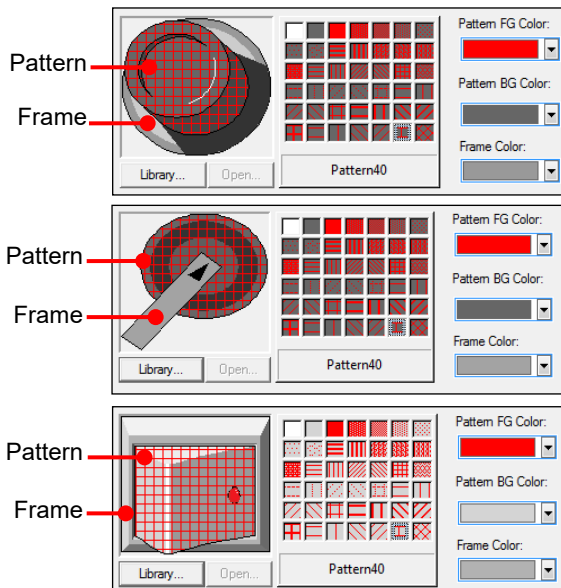

- **Pattern FG Color:** Set a color for the foreground pattern.
- **Pattern BG Color:** Set a color for the background pattern.
- **Frame Color:** Set a frame color.
- **Blink:** Set a blink speed for the object. To use the blink function, you must set the Use Lamp Condition option in the Basic settings.

Not use	The object will not blink.
Slow	The object will blink every three seconds.
Normal	The object will blink every two seconds.
Fast	The object will blink every second.

- **Text:** The text settings for bit switch objects include the following.

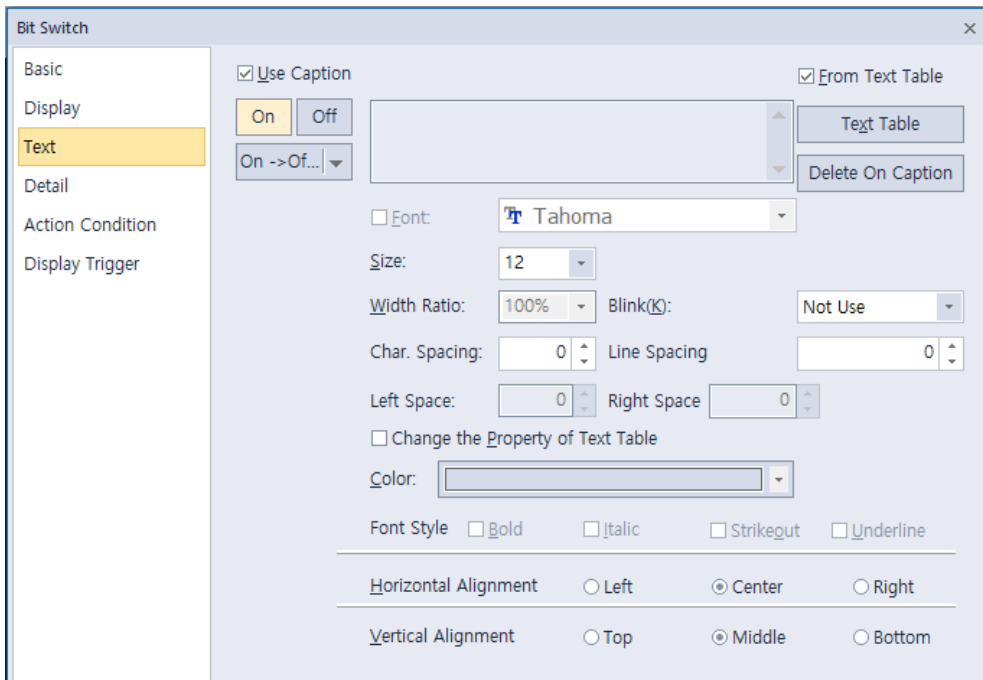

- **Use Caption:** Check the checkbox to use a text caption with the object. When you select this option, you can input text from a text table.
- **On:** Click to configure options for the object in the “On” state. You must input text in a text table.
- **Off:** Click to configure options for the object in the “Off” state. You must input text in a text table.
- **From Text Table:** Check the checkbox to add text from a text table. The Text Table option will be activated and the text input area will close. Add the required text to the text table before editing the object. You must select text for the “On” and “Off” states from the same text table.
- **Text Table:** Click to open the text table and select text. The color and font properties set in the text table will be imported with the text.

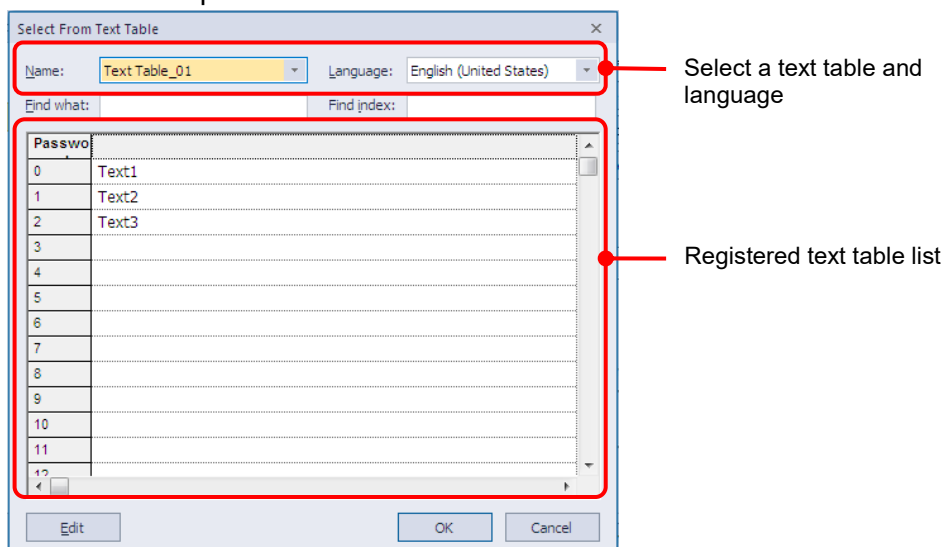

- **On <-> Off Copy:** Click to copy the text and formatting from the “On” state to the “Off” state or vice versa.
- **Copy Only Caption:** You can open the dropdown menu next to [On -> Off] to select [Copy Only Caption]. This feature allows you to copy only the currently selected text string to another state.

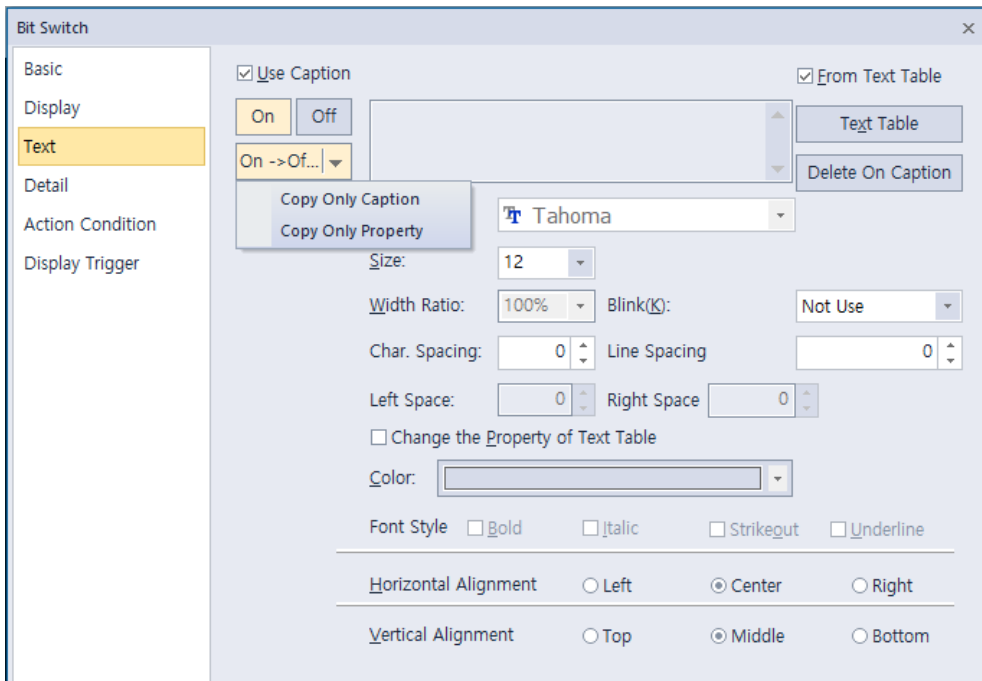

- **Copy Only Property:** You can open the dropdown menu next to [On -> Off] to select [Copy Only Property]. This feature allows you to copy all properties except the currently selected text string are copied to another state.
- **Delete On/Off Caption:** Click to clear text settings for the current state.
- **Font:** Select a font from the drop-down list.
- **Size:** Set a text size from the drop-down list or enter a value directly into the field.
- **Width Ratio:** Expand or condense the text by selecting a ratio from the drop-down list or entering a value directly in to the field. You can set a rate of 1%-600%.
- **Blink:** Set the blink speed for the caption.
XP30-BTE, XP30-TTE, XP40-TTE, and XP50-TTE are not supported.

Not use	The caption will not blink.
Slow	The caption will blink every three seconds.
Normal	The caption will blink every two seconds.
Fast	The caption will blink every second.

- **Space:** Set the space on the object. If you select Left align in Horizontal Alignment, you can set the left space, and if you select Right Align, you can set the right space.
- **Char. Spacing:** Set text intervals. If the value is a negative number, the spacing will decrease and if the value is a very small negative number, it can be overlaid or have the same effect as a positive number.
- **Line. Spacing:** Set line spacing. If the value is a negative number, the spacing will decrease, and if the value is a very small negative number, it can be overlaid of have the same effect as a positive number.
- **Change the Property of Text Table:** Click to use different color and font properties for the text than what is specified in the text table. This option is active only when you fetch text from the text table.
- **Color:** Set a font color.

- **Font Style:** Set a font style (bold, italic, strikethrough, or underline). You can apply more than one option at a time.
 - **Horizontal Alignment:** Set the horizontal alignment (Left, Center, or Right).
 - **Vertical Alignment:** Set the vertical alignment (Top, Middle, or Bottom).
- **Detail:** The detail settings for bit switch objects include the following.

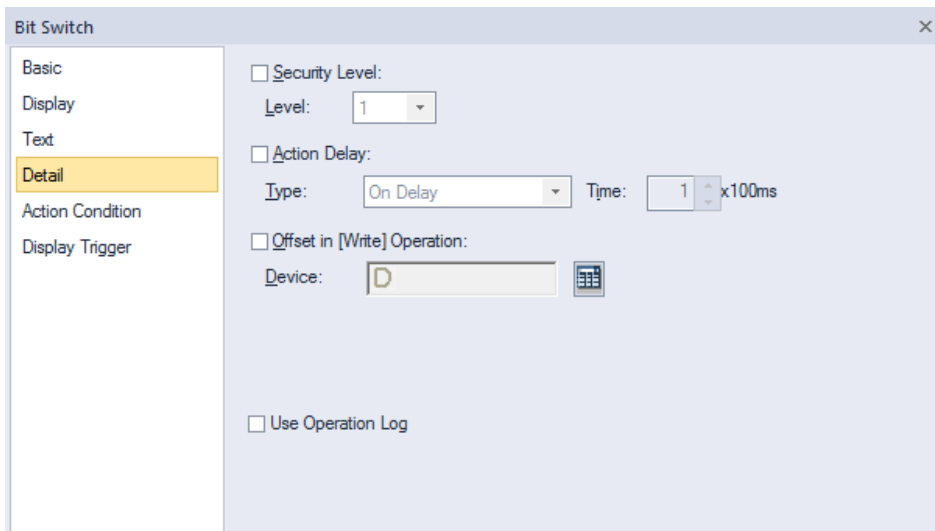

- **Security Level:** Set whether or not to require a password to use the object.
- **Level:** Set the security level for the object. The higher the security level is, the shorter the authorization time becomes when the password is entered. When the authorization time expires, the user must enter the password again to use the object.
- **Action Delay:** Set to delay the action triggered by the switch by a specified time.
- **Type:** Set the type of action delay.

On Delay	When the switch is activated, the action is performed after the delay time that you specify.
Off Delay	When the switch is released, the action is performed after the delay time that you specify.
Press Twice	When the switch is activated once, a dialog box is invoked to allow the user to verify the operation. When the switch is activated a second time, the action is performed after the delay time that you specify.

- **Time:** Set the length of time for the action delay.
- **Offset in [Write] Operation:** Set to use the Offset function.
- **Device:** Enter a device or tag address directly into the input field or click the keypad icon to the right to specify a device or tag address. When you click the keypad icon to open the Device window, you can also specify network settings, if necessary.
- **Use Operation Log:** Set to allow the device to be monitored in an operation log. XP30-BTE, XP30-TTE, XP40-TTE, and XP50-TTE are not supported.

- **Action Condition:** The action condition settings for bit switch objects include the following.

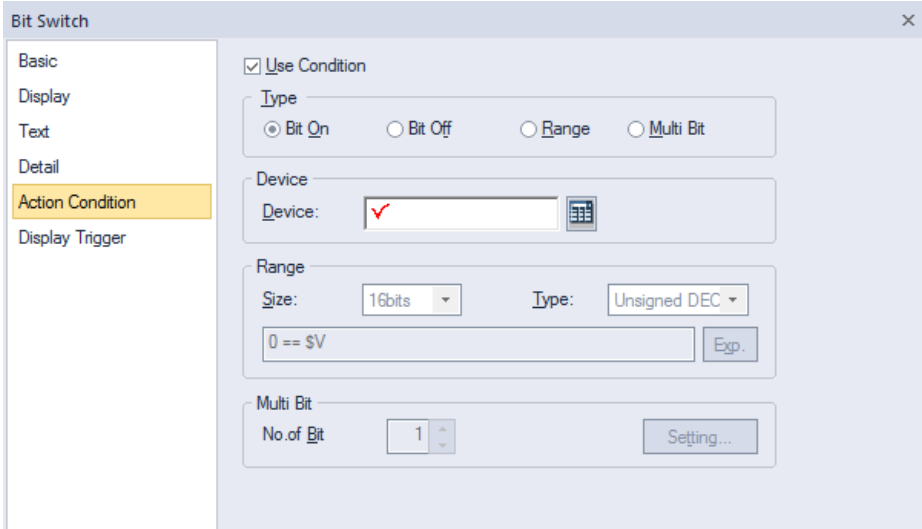

- **Use Condition:** Set whether or not to specify a condition for the action.
- **Type:** Set a type of condition to specify.

Bit On	The action is performed when the device is switched on.
Bit Off	The action is performed when the device is switched off.
Range	The action is performed when the value falls within the specified range.
Multi Bit	The action is performed when the logical operation result of multiple devices is met.

- **Device:** Enter a device or tag address directly into the input field or click the keypad icon to the right to specify a device or tag address. When you click the keypad icon to open the Device window, you can also specify network settings, if necessary.
- **Range:** If you select the range condition, specify the range.

Size	16 bit or 32 bit.
Type	Signed decimal, unsigned decimal, BCD, or float.
Exp.	Click to designate the expression as conditional.

- **Multi Bit:** If you select the multi bit condition, specify the number of bits and click [Setting] to specify the bit conditions.

- **Display Trigger:** The display trigger settings for bit switch objects include the following.

- **Use Condition:** Set whether or not to specify a condition for the display trigger.
- **Type:** Set a type of condition to specify.

Bit On	The object will display when the device is on.
Bit Off	The object will display when the device is off
Range	The object will display when the range condition of the device is satisfied.
Multi Bit	The object will display when the logical operation results of multiple device are satisfied.

- **Device:** Enter a device or tag address directly into the input field or click the keypad icon to the right to specify a device or tag address. When you click the keypad icon to open the Device window, you can also specify network settings, if necessary.
- **Range:** If you select the range condition, specify the range.

Size	16 bit or 32 bit.
Type	Signed decimal, unsigned decimal, BCD, or float.
Exp.	Click to designate the expression as conditional.
- **Multi Bit:** If you select the multi bit condition, specify the number of bits and click [Setting] to specify the bit conditions.

4.3.2.2 Word Switch

Word switch executes the script, enters a fixed value, and adds or reduces the value. This section describes available settings for word switch objects.

- **Basic:** The Basic settings for word switch objects include the following.

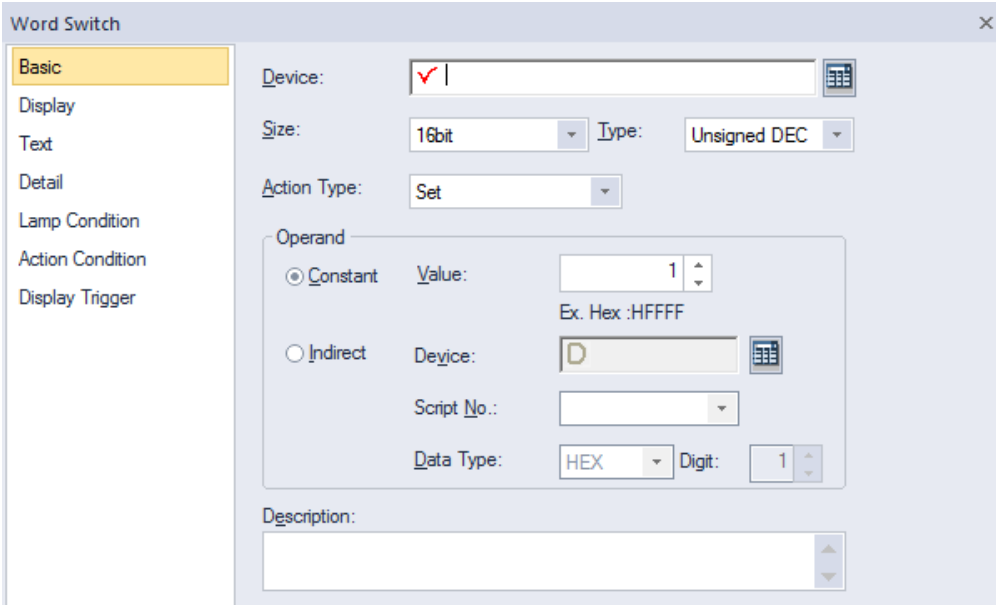

- **Device:** Enter a device or tag address directly into the input field or click the keypad icon to the right to specify a device or tag address. When you click the keypad icon to open the Device window, you can also specify network settings, if necessary.
- **Size:** Set the data size of the device (16-bit upper byte, 16-bit lower byte, 16 bit, or 32 bit).
- **Type:** Set the data form of the device (signed decimal, unsigned decimal, or float).
- **Action Type:** Set the type of the action to perform.

Set	Write the specified value in the device.																																								
Add	Add the specified value to the device value.																																								
Sub	Subtract the specified value from the device value.																																								
Script	Execute a script.																																								
Digit Add	<p>Increase the bit value of a specific location in a word device. The value is added to the current value with as many operands as you specify, but the bit value of the location increases only by the value specified here.</p> <table style="margin-left: 20px;"> <tr> <td style="border: 1px solid black; padding: 2px;">0</td> <td style="border: 1px solid black; padding: 2px;">0</td> <td style="border: 1px solid black; padding: 2px;">0</td> <td style="border: 1px solid black; padding: 2px;">0</td> <td style="border: 1px solid black; padding: 2px;">1</td> <td style="border: 1px solid black; padding: 2px;">0</td> <td style="border: 1px solid black; padding: 2px;">0</td> <td style="border: 1px solid black; padding: 2px;">0</td> </tr> <tr> <td colspan="5"></td> <td style="text-align: center;">↑</td> <td colspan="2"></td> </tr> <tr> <td colspan="5"></td> <td style="text-align: center;">3rd digit</td> <td colspan="2"></td> </tr> <tr> <td style="border: 1px solid black; padding: 2px;">0</td> <td style="border: 1px solid black; padding: 2px;">0</td> <td style="border: 1px solid black; padding: 2px;">0</td> <td style="border: 1px solid black; padding: 2px;">0</td> <td style="border: 1px solid black; padding: 2px;">1</td> <td style="border: 1px solid black; padding: 2px;">01</td> <td style="border: 1px solid black; padding: 2px;">0</td> <td style="border: 1px solid black; padding: 2px;">0</td> </tr> <tr> <td colspan="5"></td> <td style="text-align: center;">↑</td> <td colspan="2"></td> </tr> </table> <p>For example, if the device value is as above and the digit is 3, the device value will change as shown above when you operate the word switch on the XGT Panel.</p>	0	0	0	0	1	0	0	0						↑								3 rd digit			0	0	0	0	1	01	0	0						↑		
0	0	0	0	1	0	0	0																																		
					↑																																				
					3 rd digit																																				
0	0	0	0	1	01	0	0																																		
					↑																																				
Digit Sub	Decrease the bit value of a specific location in a word device. The value is subtracted from the current value with as many operands as you specify, but the bit value of the location decreases only by the value specified here.																																								

Continuous Add / Continuous Sub	This option is available for only [Add], [Sub], [Digit Add], and [Digit Sub] operations. When the switch is pressed for more than 1 second, the value increases or decreases by the increment or decrement settings made in [Constant Value]-[Value] in 0.5 second intervals. If the device value exceeds its value range (see the Note below), it is expressed as a carried number. For example, if it is a 16 bit signed decimal, subtracting 1 from -32768 makes 32767.
--	--

- **Operand:** Set the value to write to the device. The operand can be set as one of the following types.

Constant	Set a fixed value to use as an operand in the expression.
Indirect	Set to use the device value as an operand in the expression.
Script No.	Specify a script when performing actions other than adding, subtracting, writing a specific device value, or writing a fixed value.
Data Type	Set the data type to be increased or decreased. When you select BCD as the data type, if the value returned by the specified device exceeds the numeric range of BCD data (0-9), the word switch will not execute.
Digit	Set the number of digit to increase or decrease. For 16 bit devices, you can set it from 1-4. For 32-bit devices, you can set it from 1-8.

If the operand is saved as a script, the final value will be applied to the device after completing the calculation. The description below shows how it works.

1. Read the value from the device specified in the word switch and save the value to the temporary variable referring to the device.
2. Operate the script on the read value.
3. Apply the value saved on the temporary variable after operating the script.

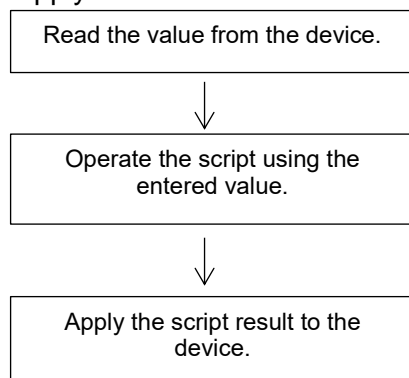

- From the flow chart above, the script result means “the value of the temporary variable when the script ends.” If the device value changes during operating the script, it will not affect the script.
- If you change the device value using a direct variable while the script is in operation, the change will not remain because the value of the temporary variable after the script ends will be written to the device. If you use the device within a script, a message such as “2012: The standard device exists in the specified ‘SCRIPT.’ An unexpected result might occur.” will be displayed.

Note

If you set a fixed constant operand, the range of the constant varies based on the size and type of the device, as described in the following table.

Device Size	Device Type	Minimum	Maximum
16-bit upper byte	Signed decimal	-128	127
16-bit upper byte	Unsigned decimal, binary, hexadecimal, octal	0	255
16-bit lower byte	Signed decimal	-128	127
16-bit lower byte	Unsigned decimal, binary, hexadecimal, octal	0	255
16 bit	Signed decimal	-32,768	32,767
	Unsigned decimal	0	65,535
	BCD	0	9,999
32 bit	Signed decimal	-2147,483,648	2,147,483,647
	Unsigned decimal	0	4,294,967,295
	BCD	0	99999999

- **Description:** Enter a description for the object.

- **Display:** The display settings for word switch objects include the following.

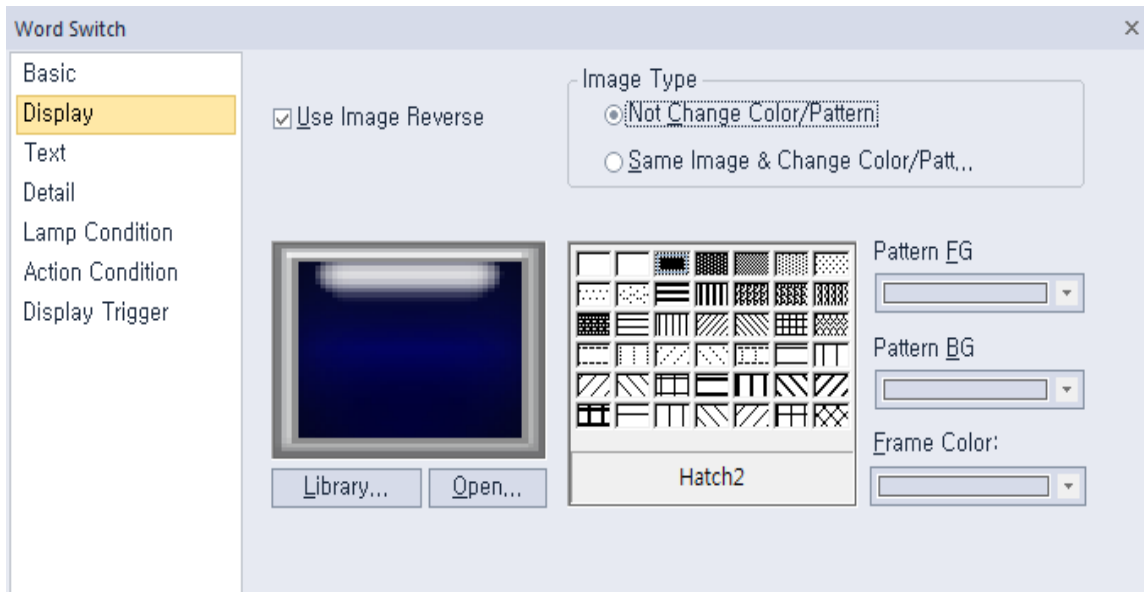

- **Transparent BG Image:** Check the checkbox to make the image background transparent. You cannot use a transparent background and the reverse image setting at the same time.
- **Use Image Reverse:** The switch image is reversed when you tap the object or a condition is met. If you set this option, you cannot use the **Transparent BG Image** option or the On/Off image. If you set the **Transparent BG Image** option, you cannot use this option.
- **On:** Click to configure options for the object in the “On” state.
- **Off:** Click to configure options for the object in the “Off” state.
- **Off->On Copy:** Copies all image properties in the Off state to On.
- **On->Off Copy:** Copies all image properties in On status to Off.
- **Image Type:** Set whether or not to change colors and patterns when switching between “On” and “Off” states. If you select the change color or pattern option, you must select a vector image for the object. To view characteristics of raster or vector images, refer to **<2.4.1 Managing Graphic Libraries>**.

Not Change Color/Pattern	Use the original image. You can apply the pattern or color to the image. Select the image to display for On/Off status from raster, vector, or user registered images.
Same Image & Change Color/Pattern in On/Off	Select a vector image. You cannot select a raster image. Apply a pattern or color to the image.

- **Library:** Click to select an image from the library.
- **Open:** Click to browse for images on your computer. When you select an image from your computer, it will be added to the image library automatically.
- **Pattern:** Click a pattern to apply to the image. This option is available only when you select the change color or pattern option in **Image Type**. Patterns are applied to specific parts of objects, but not to the frames. The frames are different for each image. Refer the following examples:

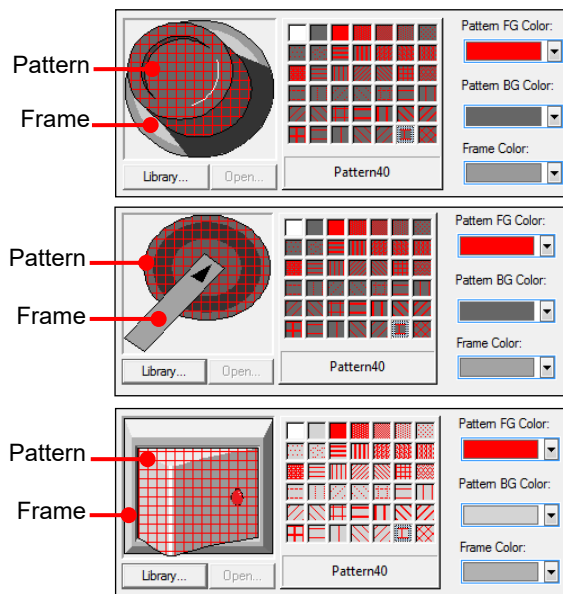

- **Pattern FG Color:** Set a color for the foreground pattern.
- **Pattern BG Color:** Set a color for the background pattern.
- **Frame Color:** Set a frame color.
- **Blink:** Set a blink speed for the object. You can use this option when you check **Use Lamp Condition** in the Lamp Condition settings.

Not use	The object will not blink.
Slow	The object will blink every three seconds.
Normal	The object will blink every two seconds.
Fast	The object will blink every second.

- **Text:** The text settings for word switch objects include the following.

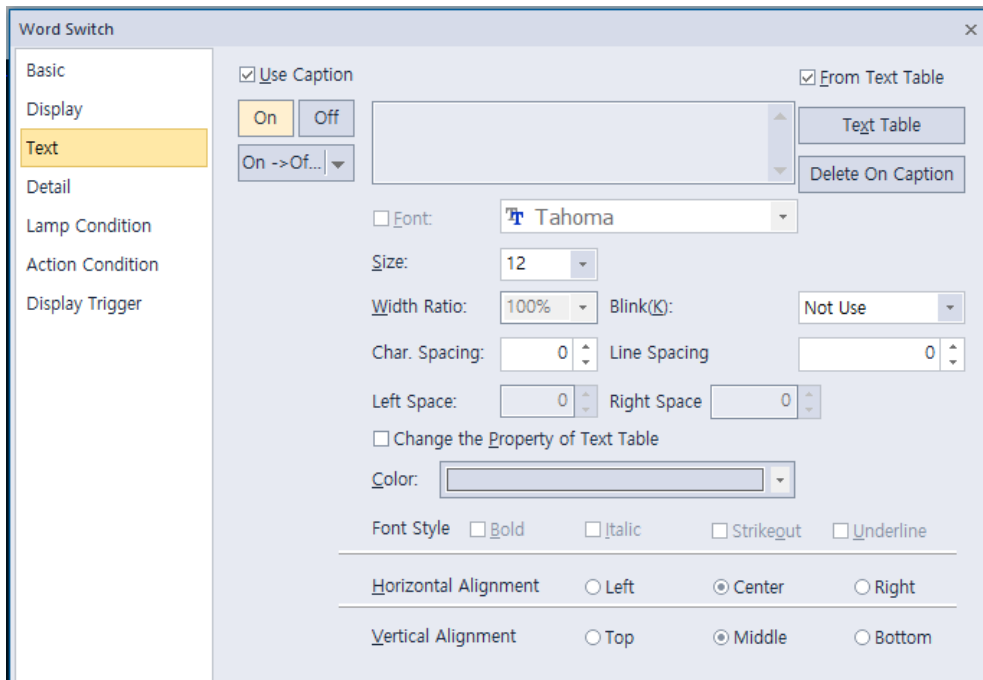

- **Use Caption:** Check the checkbox to use a text caption with the object. When you select this option, you can input text from a text table.
- **On:** Click to configure options for the object in the “On” state. You must input the text in a text table.
- **Off:** Click to configure options for the object in the “Off” state. You must input the text in a text table.
- **From Text Table:** Click the checkbox to add text from a text table. The Text Table option will be activated and the text input area will close. Add the required text to the text table before editing the object. You must select text for the “On” and “Off” states from the same text table.
- **Text Table:** Click to open the text table and select text. The color and font properties set in the text table will be imported with the text.

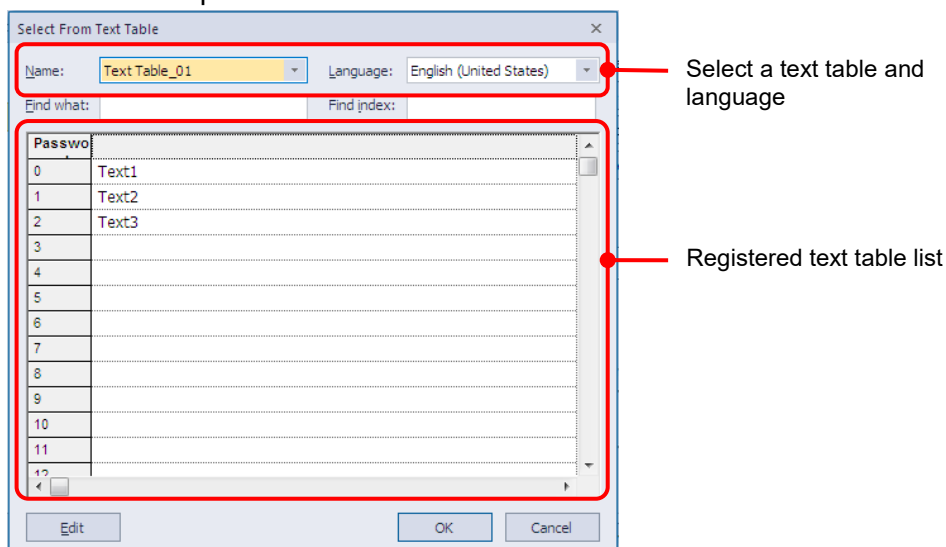

- **On <-> Off Copy:** Click to copy the text and formatting from the “On” state to the “Off” state or vice versa.
- **Copy Only Caption:** You can open the dropdown menu next to [On -> Off] to select [Copy Only Caption]. This feature allows you to copy only the currently selected text string to another state.

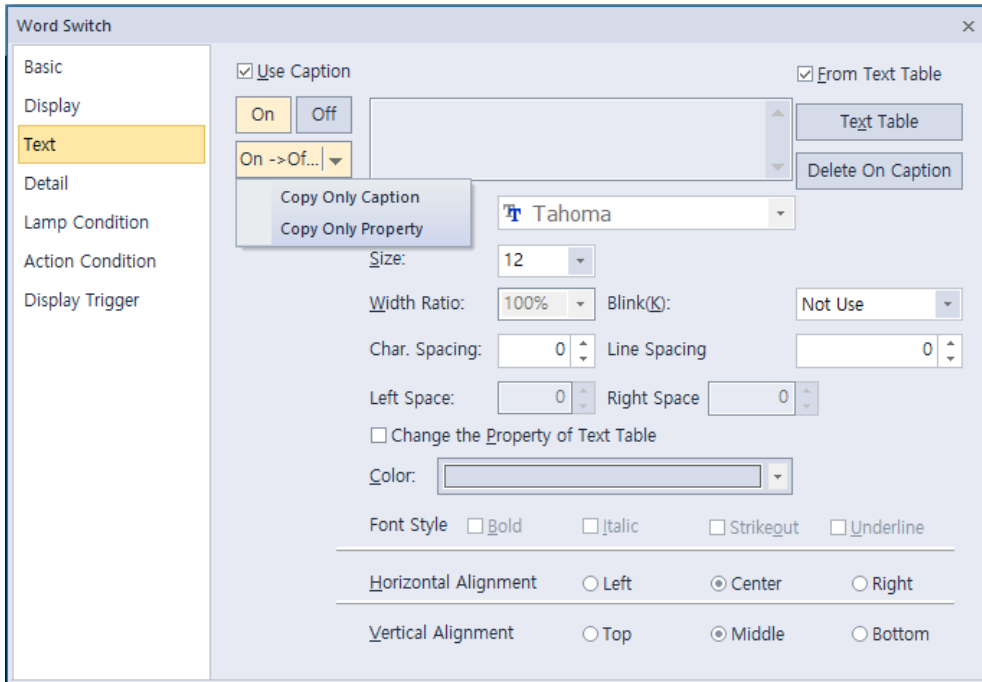

- **Copy Only Property:** You can open the dropdown menu next to [On -> Off] to select [Copy Only Property]. This feature allows you to copy all properties except the currently selected text string are copied to another state.
- **Delete On/Off Caption:** Click to clear text settings for the current state.
- **Font:** Select a font from the drop-down list.
- **Size:** Set a text size from the drop-down list or enter a value directly into the field.
- **Width Ratio:** Expand or condense the text by selecting a ratio from the drop-down list or entering a value directly in to the field. You can set a rate of 1%-600%.
- **Blink:** Set the blink speed for the caption.
XP30-BTE, XP30-TTE, XP40-TTE, and XP50-TTE are not supported.

Not use	The caption will not blink.
Slow	The caption will blink every three seconds.
Normal	The caption will blink every two seconds.
Fast	The caption will blink every second.

- **Space:** Set the space on the object. If you select Left align in Horizontal Alignment, you can set the left space, and if you select Right Align, you can set the right space.
- **Char. Spacing: Set text** intervals. If the value is a negative number, the spacing will decrease and if the value is a very small negative number, it can be overlaid or have the same effect as a positive number.
- **Line. Spacing: Set line** spacing. If the value is a negative number, the spacing will decrease, and if the value is a very small negative number, it can be overlaid of have the same effect as a positive number
- **Change the Property of Text Table:** Click to use different color and font properties for the text than what is specified in the text table. This option is active only when you fetch text from the text table.
- **Color:** Set a font color.

- **Font Style:** Set a font style (bold, italic, strikethrough, or underline). You can apply more than one option at a time.
 - **Horizontal Alignment:** Set the horizontal alignment (Left, Center, or Right).
 - **Vertical Alignment:** Set the vertical alignment (Top, Middle, or Bottom).
- **Detail:** The detail settings for word switch objects include the following.

The screenshot shows the 'Word Switch' configuration window with the 'Detail' tab selected. The settings are as follows:

- Security Level:** Level: 1
- Action Delay:** Type: On Delay, Time: 1 x100ms
- Offset in [Write] Operation:** Device: D
- Use Operation Log**

- **Security Level:** Set whether or not to require a password to use the object.
- **Level:** Set the security level for the object. The higher the security level, the shorter the authorization time when the password is entered. When the authorization time expires, the user must enter the password again to use the object.
- **Action Delay:** Set to delay the action triggered by the switch by a specified time.
- **Type:** Set the type of action delay.

On Delay	When the switch is activated, the action is performed after the delay time that you specify.
Press Twice	When the switch is activated once, a dialog box is invoked to allow the user to verify the operation. When the switch is activated a second time, the action is performed after the delay time that you specify.

- **Time:** Set the length of time for the action delay.
- **Offset in [Write] Operation:** Set to use the Offset function.
- **Device:** Enter a device or tag address directly into the input field or click the keypad icon to the right to specify a device or tag address. When you click the keypad icon to open the Device window, you can also specify network settings, if necessary.
- **Use Operation Log:** Set to allow the device to be monitored in an operation log. XP30-BTE, XP30-TTE, XP40-TTE, and XP50-TTE are not supported.

- **Lamp Condition:** The lamp condition settings for word switch objects include the following.

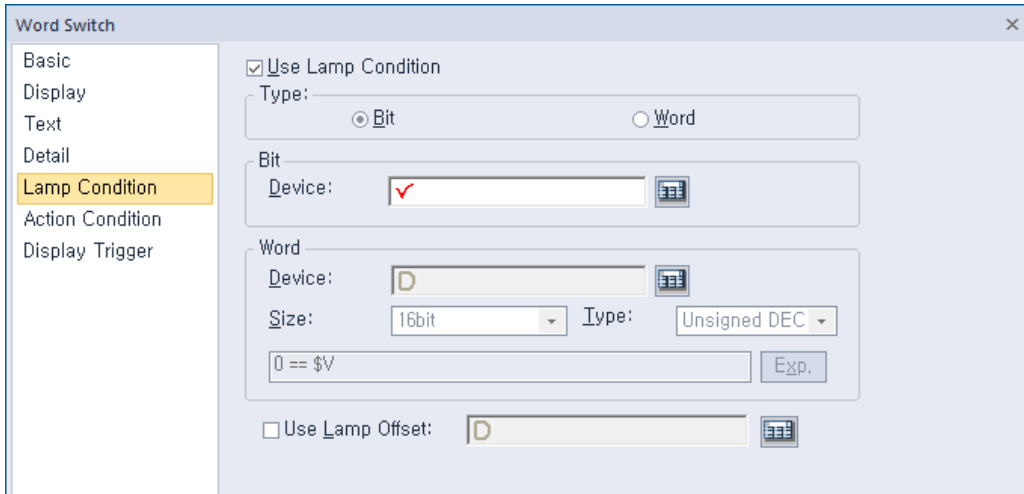

- **Use Lamp Condition:** If you want to control a lamp with a method other than simply turning it on when the switch is activated, you can select a different action.
- **Type:** Select a condition for lamp control.

Bit	When the device state is “On”, the lamp is on.
Word	When the condition is met, the lamp is on.

- **Bit:** If you selected the bit condition type, specify a bit device.

Device	Enter a device or tag address directly into the input field or click the keypad icon to the right to specify a device or tag address. When you click the keypad icon to open the Device window, you can also specify network settings, if necessary.
---------------	--

- **Word:** If you selected the word condition type, specify a word device.

Device	Enter a device or tag address directly into the input field or click the keypad icon to the right to specify a device or tag address. When you click the keypad icon to open the Device window, you can also specify network settings, if necessary.
Size	16-bit upper byte, 16-bit lower byte, 16 bit, or 32 bit.
Type	Signed decimal, unsigned decimal, BCD, or float.
Exp.	Click to designate the expression as conditional.

- **Use Lamp Offset:** Click to set an offset for the lamp.

- **Action Condition:** The action condition settings for word switch objects include the following.

- **Use Condition:** Set whether or not to specify a condition for the action.
- **Type:** Set a type of condition to specify.

Bit On	The action is performed when the device is switched on.
Bit Off	The action is performed when the device is switched off.
Range	The action is performed when the value falls within the specified range.
Multi Bit	The action is performed when the logical operation result of multiple devices is met.

- **Device:** Enter a device or tag address directly into the input field or click the keypad icon to the right to specify a device or tag address. When you click the keypad icon to open the Device window, you can also specify network settings, if necessary.
- **Range:** If you select the range condition, specify the range.

Size	16 bit or 32 bit.
Type	Signed decimal, unsigned decimal, BCD, or float.
Exp.	Click to designate the expression as conditional.
- **Multi Bit:** If you select the multi bit condition, specify the number of bits and click [Setting] to specify the bit conditions.

- **Display Trigger:** The display trigger settings for word switch objects include the following.

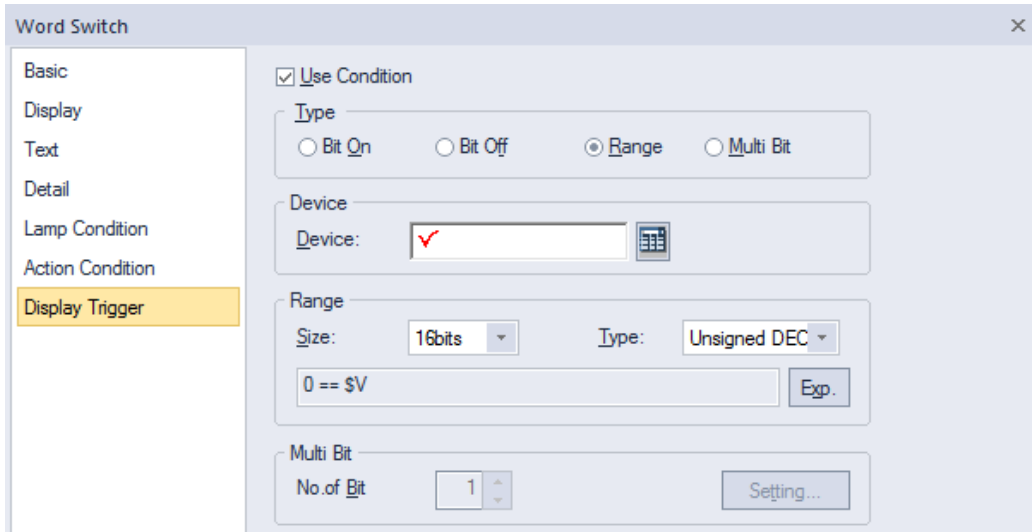

- **Use Condition:** Set whether or not to specify a condition for the display trigger.
- **Type:** Set a type of condition to specify.

Bit On	The object will display when the device is on.
Bit Off	The object will display when the device is off
Range	The object will display when the range condition of the device is satisfied.
Multi Bit	The object will display when the logical operation results of multiple device are satisfied.

- **Device:** Enter a device or tag address directly into the input field or click the keypad icon to the right to specify a device or tag address. When you click the keypad icon to open the Device window, you can also specify network settings, if necessary.
- **Range:** If you select the range condition, specify the range.

Size	16 bit or 32 bit.
Type	Signed decimal, unsigned decimal, BCD, or float.
Exp.	Click to designate the expression as conditional.

- **Multi Bit:** If you select the multi bit condition, specify the number of bits and click [Setting] to specify the bit conditions.

4.3.2.3 Change Screen Switch

The Change screen switch allows the user to switch screens in the interface. You can specify the type of screen to change to when the switch is activated. This section describes available settings for change screen switch objects.

- **Basic:** The basic settings for change screen switch objects include the following.

- **Screen:** Select a type of screen to change to.
- **Type:** Set how the screen changes.

Device	The screen switches to the screen number that matches the device value. If no screen matches the device value, the screen does not change.
Const	The screen switches to a specified screen, regardless of the device value.
Screen No.	Set the screen number or click [Browse] to locate a screen.

If [Project Properties > Screen Settings > Change Screen by Device] is set, the screen change switch will first attempt to write the screen number to the corresponding 'Change to Screen Number' device. If the communication is normal, the value is written to the relevant device and the screen is switched. However, if the communication is disconnected, the communication will be repeated as much as the [Timeout * Retry count] time entered in [Project Property > XGT Panel Settings]. And even if the time fails to write the value to screen change device, the screen is changed. In this state, if communication is resumed and the value of screen change device is read, it returns to the screen corresponding to the value.

- **Screen Change Type:** Select a method for changing screens.

Fixed	The screen switches to a specified screen.
Previous	The screen switches to the previous screen.

- **Description:** Enter a description for the object.
- **Offset When Using Import:** Set to apply an offset to the screen number when importing a screen that contains a change screen switch.

When you do not select this option, the screen number will not change after importing.

Type
 Device Screen No. :
 Const
 Offset when using import

The screen number does not change and retains the screen number 1 that is set when exporting.

Screens to be added in current project-----

No.	Screen No.	Screen name	Screen Type	Screen Offset	Tag/Text
1	4000	Base Screen	Base Screen	1500	
2					
3					

When you select this option, the screen number, plus the offset, will be set to the change screen switch.

Type
 Device Screen No. :
 Const
 Offset when using import

Screens to be added in current project-----

No.	Screen No.	Screen name	Screen Type	Screen Offset	Tag/Text
1	4000	Base Screen	Base Screen	1500	
2					
3					

Type
 Device Screen No. :
 Const
 Offset when using import

- **Display:** The display settings for change screen switch objects include the following.

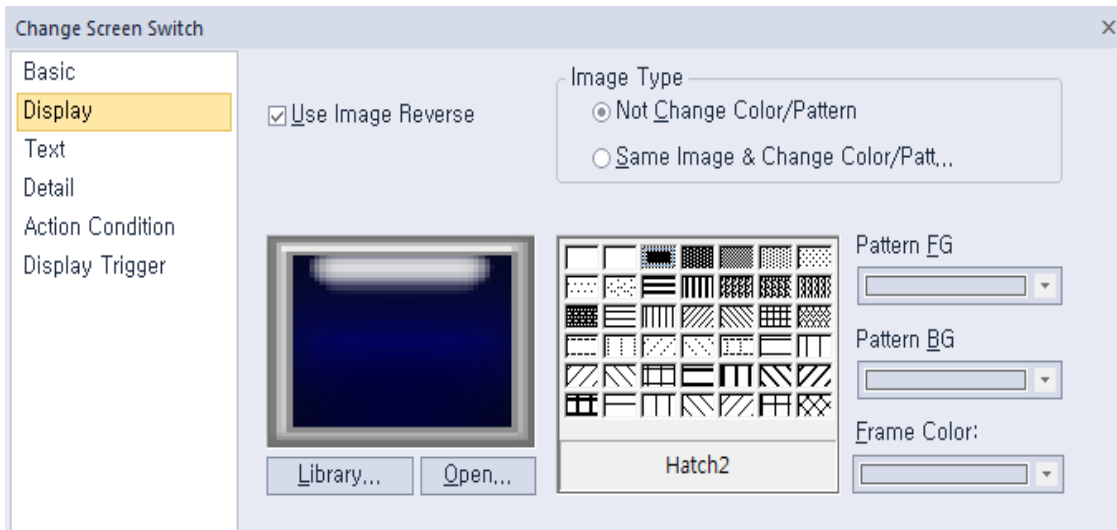

- **Transparent BG Image:** Click the checkbox to make the image background transparent. You cannot use a transparent background and the reverse image setting at the same time.
- **Use Image Reverse:** The switch image is reversed when you tap the object or a condition is met. If you set this option, you cannot use the **Transparent BG Image** option or the On/Off image. If you set the **Transparent BG Image** option, you cannot use this option.
- **On:** Click to configure options for the object in the “On” state.
- **Off:** Click to configure options for the object in the “Off” state.
- **Off->On Copy:** Copies all image properties in the Off state to On.
- **On->Off Copy:** Copies all image properties in On status to Off.
- **Image Type:** Set whether or not to change colors and patterns when switching between “On” and “Off” states. If you select the change color or pattern option, you must select a vector image for the object. To view characteristics of raster or vector images, refer to **<2.4.1 Managing Graphic Libraries>**.

Not Change Color/Pattern	Use the original image. You can apply the pattern or color to the image. Select the image to display for On or Off status from raster, vector, or user-registered images.
Same Image & Change Color/Pattern in On/Off	Select a vector image. You cannot select a raster image. Apply a pattern or color to the image.

- **Library:** Click to select an image from the library.
- **Open:** Click to browse for images on your computer. When you select an image from your computer, it will be added to the image library automatically.
- **Pattern:** Click a pattern to apply to the image. This option is available only when you select the Change Color or Pattern option in **Image Type**. Patterns are applied to specific parts of objects, but not to the frames. The frames are different for each image. Refer the following examples:

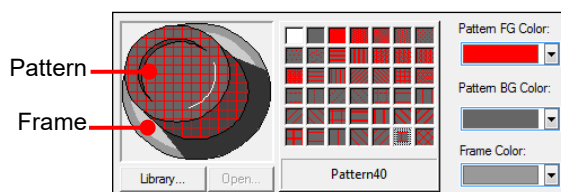

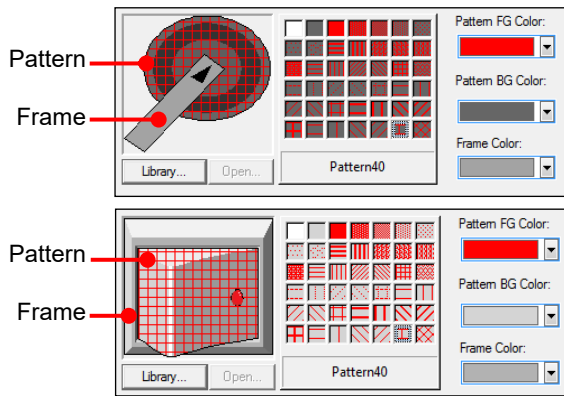

- **Pattern FG Color:** Set a color for the foreground pattern.
- **Pattern BG Color:** Set a color for the background pattern.
- **Frame Color:** Set a frame color.

- **Text:** The text settings for screen change object include the following.

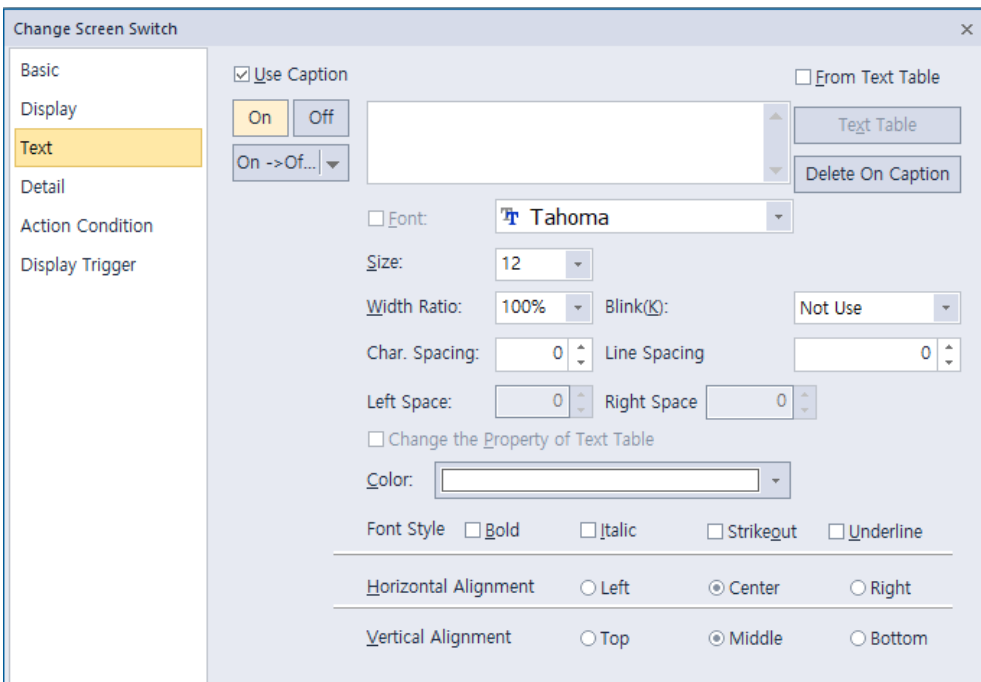

- **Use Caption:** Click the checkbox to use a text caption with the object. When you select this option, you can input text from a text table.
- **On:** Click to configure options for the object in the “On” state. You must input the text in a text table.
- **Off:** Click to configure options for the object in the “Off” state. You must input the text in a text table.
- **From Text Table:** Click the checkbox to add text from a text table. The Text Table option will be activated and the text input area will close. Add the required text to the text table before editing the object. You must select text for the “On” and “Off” states from the same text table.
- **Text Table:** Click to open the text table and select text. The color and font properties set in the text table will be imported with the text.

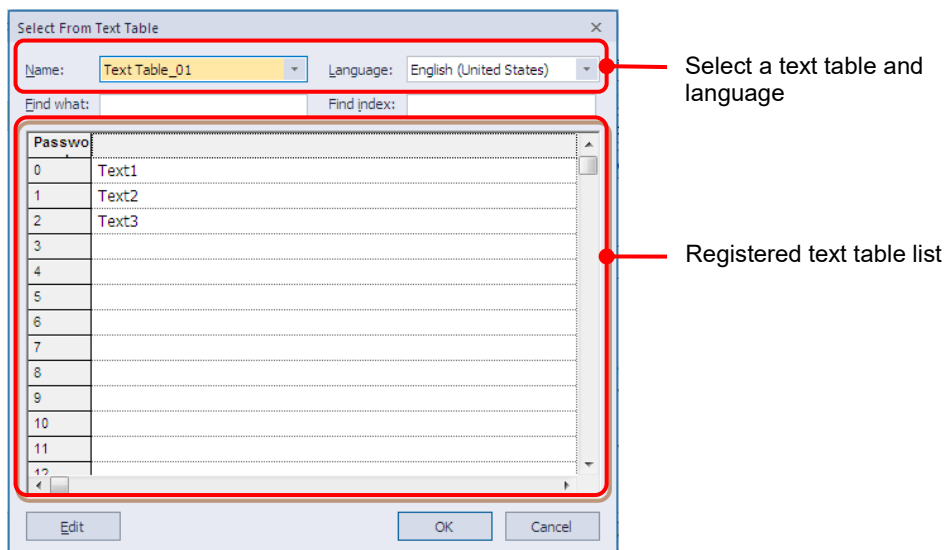

- **On <-> Off Copy:** Click to copy the text and formatting from the “On” state to the “Off” state or vice versa.
- **Copy Only Caption:** You can open the dropdown menu next to [Copy to other state] to select [Copy Only Caption]. This feature allows you to copy only the currently selected text string to another state.

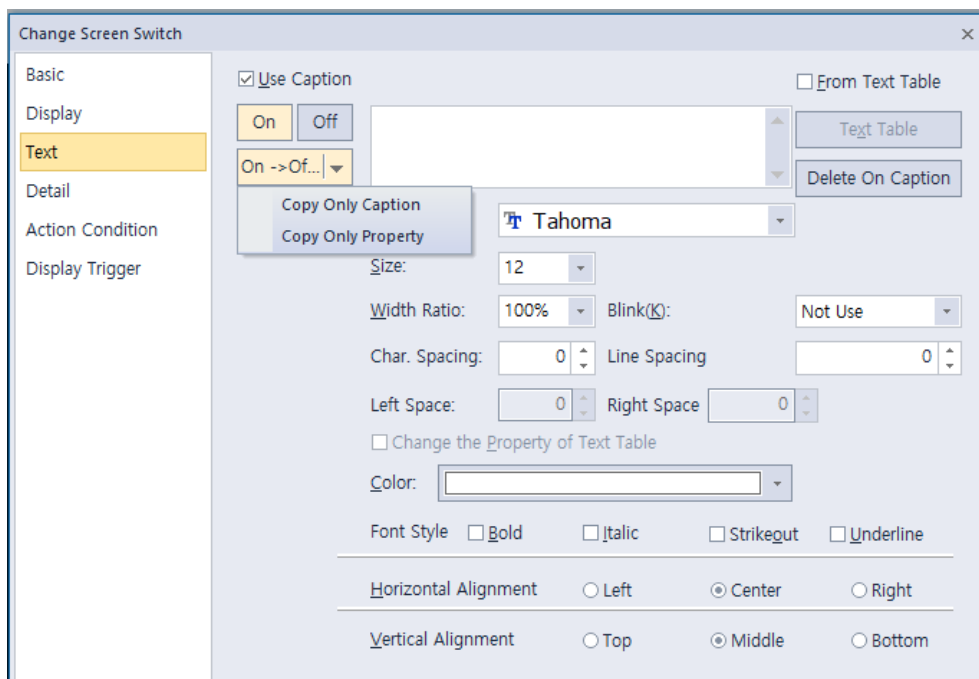

- **Copy Only Property:** You can open the dropdown menu next to [On -> Off] to select [Copy Only Property]. This feature allows you to copy all properties except the currently selected text string are copied to another state.
- **Delete On/Off Caption:** Click to clear text settings for the current state.
- **Font:** Select a font from the drop-down list.
- **Size:** Set a text size from the drop-down list or enter a value directly into the field.
- **Width Ratio:** Expand or condense the text by selecting a ratio from the drop-down list or entering a value directly in to the field. You can set a rate of 1%-600%.

- **Blink:** Set the blink speed for the caption.
XP30-BTE, XP30-TTE, XP40-TTE, and XP50-TTE are not supported.

Not use	The caption will not blink.
Slow	The caption will blink every three seconds.
Normal	The caption will blink every two seconds.
Fast	The caption will blink every second.

- **Space:** Set the space on the object. If you select Left align in Horizontal Alignment, you can set the left space, and if you select Right Align, you can set the right space.
- **Char. Spacing: Set text** intervals. If the value is a negative number, the spacing will decrease and if the value is a very small negative number, it can be overlaid or have the same effect as a positive number.
- **Line. Spacing: Set line** spacing. If the value is a negative number, the spacing will decrease, and if the value is a very small negative number, it can be overlaid of have the same effect as a positive number.
- **Change the Property of Text Table:** Click to use different color and font properties for the text than what is specified in the text table. This option is active only when you fetch text from the text table.
- **Color:** Set a font color.
- **Font Style:** Set a font style (bold, italic, strikeout, or underline). You can apply more than one option at a time.
- **Horizontal Alignment:** Set the horizontal alignment (Left, Center, or Right).
- **Vertical Alignment:** Set the vertical alignment (Top, Middle, or Bottom).

- **Detail:** The detail settings for change screen switch objects include the following.

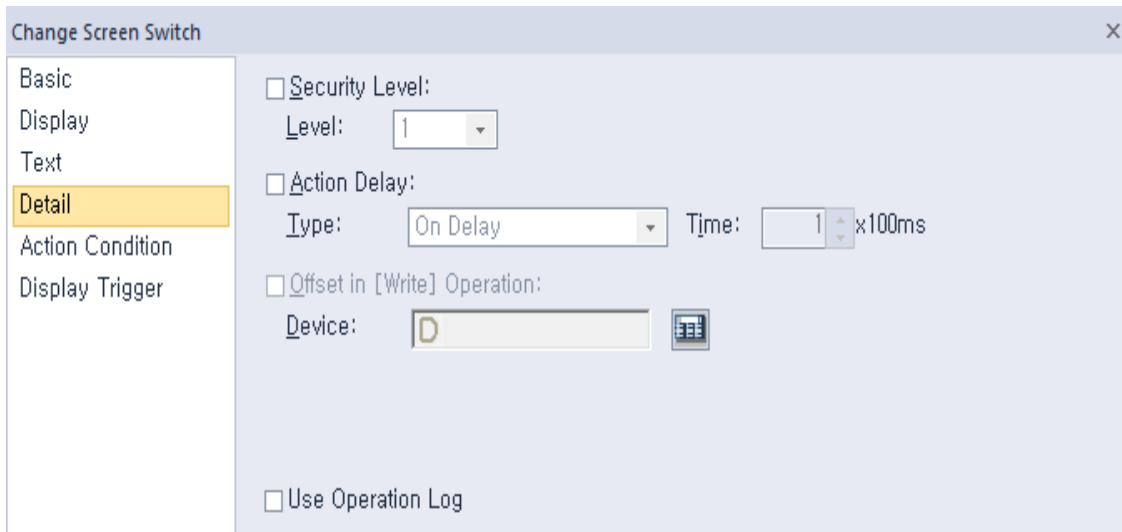

- **Security Level:** Set whether or not to require a password to use the object.
- **Level:** Set the security level for the object. The higher the security level, the shorter the authorization time when the password is entered. When the authorization time expires, the user must enter the password again to use the object.
- **Action Delay:** Set to delay the action triggered by the switch by a specified time.
- **Type:** Set the type of action delay.

On Delay	When the switch is activated, the action is performed after the delay time that you specify.
Press Twice	When the switch is activated once, a dialog box is invoked to allow the user to verify the operation. When the switch is activated a second time, the action is performed after the delay time that you specify.

- **Offset in [Write] Operation:** Set to use the Offset function. The change screen switch does not support this function.
- **Device:** Enter a device or tag address directly into the input field or click the keypad icon to the right to specify a device or tag address. When you click the keypad icon to open the Device window, you can also specify network settings, if necessary.
- **Use Operation Log:** Set to allow the device to be monitored in an operation log. XP30-BTE, XP30-TTE, XP40-TTE, and XP50-TTE are not supported.

- **Action Condition:** The action condition settings for change screen switch objects include the following.

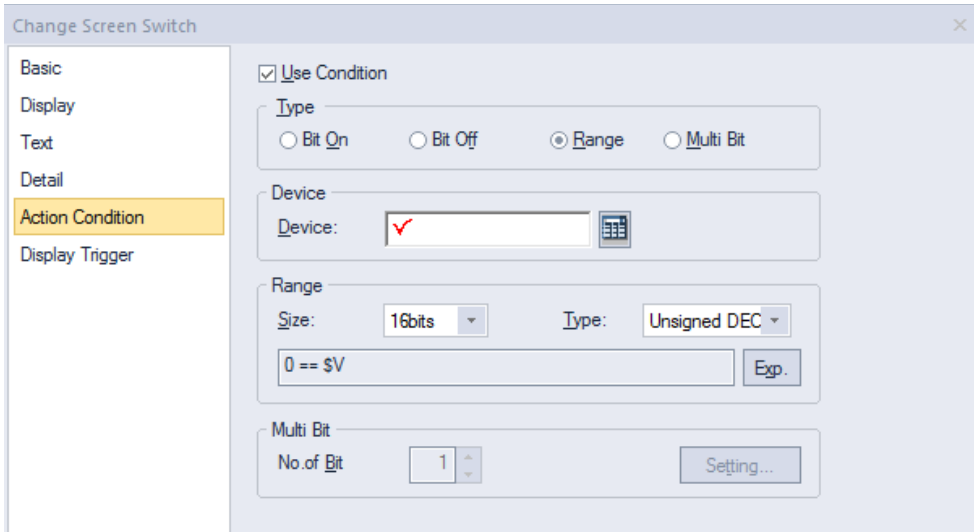

- **Use Condition:** Set whether or not to specify a condition for the action.
- **Type:** Set a type of condition to specify.

Bit On	The action is performed when the device is switched on.
Bit Off	The action is performed when the device is switched off.
Range	The action is performed when the value falls within the specified range.
Multi Bit	The action is performed when the logical operation result of multiple devices is met.

- **Device:** Enter a device or tag address directly into the input field or click the keypad icon to the right to specify a device or tag address. When you click the keypad icon to open the Device window, you can also specify network settings, if necessary.
- **Range:** If you select the range condition, specify the range.

Size	16 bit or 32 bit.
Type	Signed decimal, unsigned decimal, BCD, or float.
Exp.	Click to designate the expression as conditional.

- **Multi Bit:** If you select the multi bit condition, specify the number of bits and click [Setting] to specify the bit conditions.

- **Display Trigger:** The display trigger settings for change screen switch objects include the following.

- **Use Condition:** Set whether or not to specify a condition for the display trigger.
- **Type:** Set a type of condition to specify.

Bit On	The object will display when the device is on.
Bit Off	The object will display when the device is off
Range	The object will display when the range condition of the device is satisfied.
Multi Bit	The object will display when the logical operation results of multiple device are satisfied.

- **Device:** Enter a device or tag address directly into the input field or click the keypad icon to the right to specify a device or tag address. When you click the keypad icon to open the Device window, you can also specify network settings, if necessary.
- **Range:** If you select the range condition, specify the range.

Size	16 bit or 32 bit.
Type	Signed decimal, unsigned decimal, BCD, or float.
Exp.	Click to designate the expression as conditional.

- **Multi Bit:** If you select the multi bit condition, specify the number of bits and click [Setting] to specify the bit conditions.

4.3.2.4 Special Switch

This switch is for carrying out key code, alarm, logging, printing, language switching, script operation, and other storage-related actions. This section describes available settings for special switch objects.

- **Basic:** The basic settings for special switch objects include the following. You can select the function for the special switch and set the properties in the **Special Switch Function** settings.

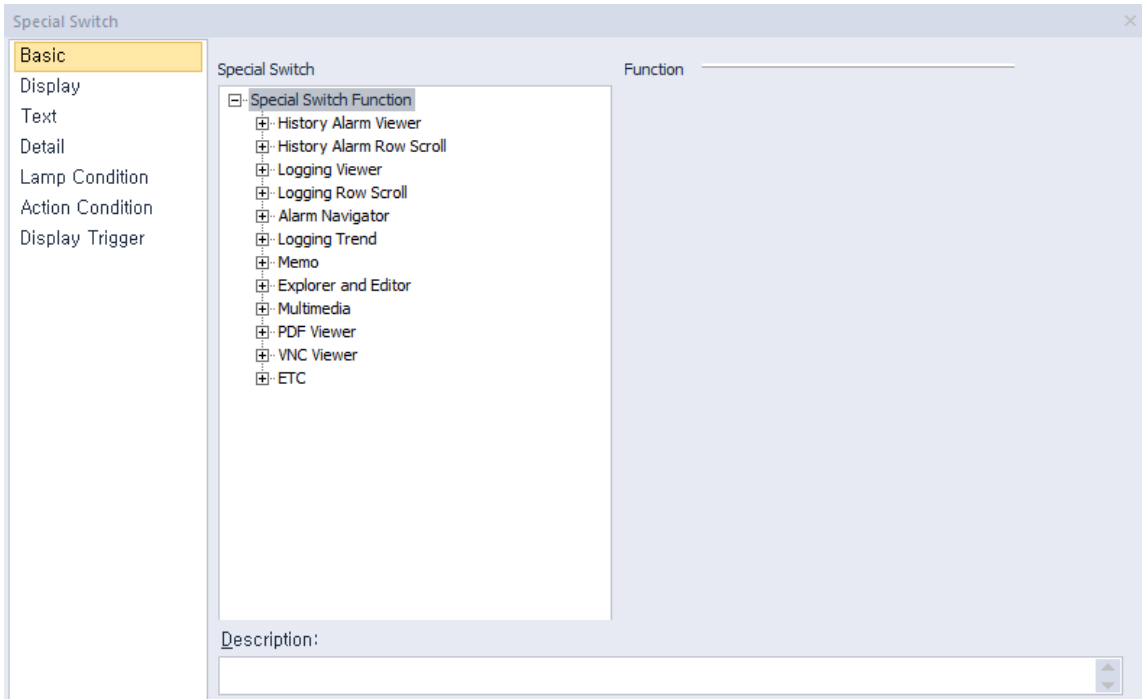

– **History Alarm Viewer**

Function	Description																														
Alarm Group Filtering	Set to filter the history alarms by the group.																														
Check All Alarm Data in Alarm Page	Set to view all alarm data or only specified alarm data by selecting the alarm. The view time is recorded for both cases.																														
Check Selected Alarm Data in Alarm Viewer	<ul style="list-style-type: none"> • When checking all data <table border="1"> <thead> <tr> <th>Occurrence</th> <th>Message</th> <th>Group</th> <th>Recovery</th> <th>Acknowledge</th> </tr> </thead> <tbody> <tr> <td>2007/07/19</td> <td>Thank you1</td> <td>Thank you1</td> <td></td> <td></td> </tr> <tr> <td>2007/07/19</td> <td>Thank you2</td> <td>Thank you1</td> <td></td> <td></td> </tr> <tr> <td>2007/07/19</td> <td>Thank you3</td> <td>Thank you1</td> <td></td> <td></td> </tr> <tr> <td>2007/07/19</td> <td>Thank you4</td> <td>Thank you1</td> <td></td> <td></td> </tr> <tr> <td>2007/07/19</td> <td>Thank you5</td> <td>Thank you1</td> <td></td> <td></td> </tr> </tbody> </table>	Occurrence	Message	Group	Recovery	Acknowledge	2007/07/19	Thank you1	Thank you1			2007/07/19	Thank you2	Thank you1			2007/07/19	Thank you3	Thank you1			2007/07/19	Thank you4	Thank you1			2007/07/19	Thank you5	Thank you1		
Occurrence	Message	Group	Recovery	Acknowledge																											
2007/07/19	Thank you1	Thank you1																													
2007/07/19	Thank you2	Thank you1																													
2007/07/19	Thank you3	Thank you1																													
2007/07/19	Thank you4	Thank you1																													
2007/07/19	Thank you5	Thank you1																													

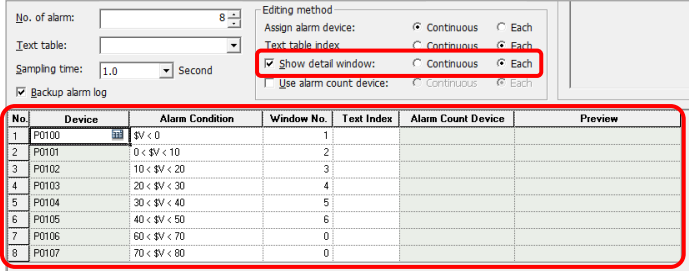
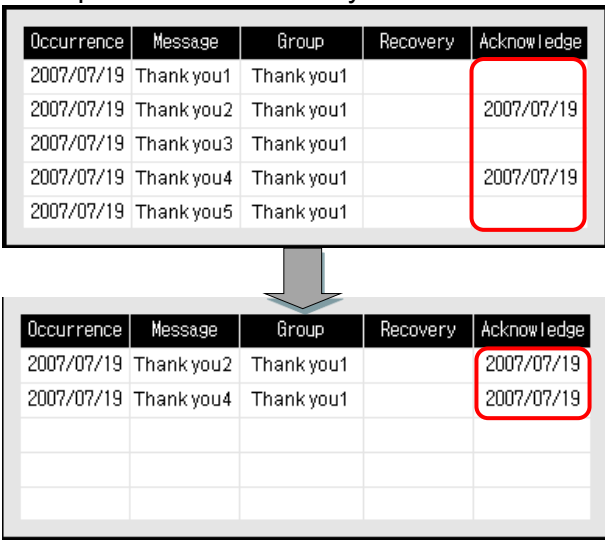

Function	Description																																																																																										
	<table border="1" style="width: 100%; border-collapse: collapse;"> <thead> <tr> <th style="background-color: #cccccc;">Occurrence</th> <th style="background-color: #cccccc;">Message</th> <th style="background-color: #cccccc;">Group</th> <th style="background-color: #cccccc;">Recovery</th> <th style="background-color: #cccccc;">Acknowledge</th> </tr> </thead> <tbody> <tr> <td>2007/07/19</td> <td>Thank you1</td> <td>Thank you1</td> <td></td> <td style="border: 2px solid red;">2007/07/19</td> </tr> <tr> <td>2007/07/19</td> <td>Thank you2</td> <td>Thank you1</td> <td></td> <td>2007/07/19</td> </tr> <tr> <td>2007/07/19</td> <td>Thank you3</td> <td>Thank you1</td> <td></td> <td>2007/07/19</td> </tr> <tr> <td>2007/07/19</td> <td>Thank you4</td> <td>Thank you1</td> <td></td> <td>2007/07/19</td> </tr> <tr> <td>2007/07/19</td> <td>Thank you5</td> <td>Thank you1</td> <td></td> <td>2007/07/19</td> </tr> </tbody> </table> <p>• When checking the selected alarm data</p> <table border="1" style="width: 100%; border-collapse: collapse;"> <thead> <tr> <th style="background-color: #cccccc;">Occurrence</th> <th style="background-color: #cccccc;">Message</th> <th style="background-color: #cccccc;">Group</th> <th style="background-color: #cccccc;">Recovery</th> <th style="background-color: #cccccc;">Acknowledge</th> </tr> </thead> <tbody> <tr> <td>2007/07/19</td> <td>Thank you1</td> <td>Thank you1</td> <td></td> <td>2007/07/19</td> </tr> <tr style="background-color: #0000ff; color: white;"> <td>2007/07/19</td> <td>Thank you2</td> <td>Thank you1</td> <td></td> <td></td> </tr> <tr> <td>2007/07/19</td> <td>Thank you3</td> <td>Thank you1</td> <td></td> <td></td> </tr> <tr> <td>2007/07/19</td> <td>Thank you4</td> <td>Thank you1</td> <td></td> <td></td> </tr> <tr> <td>2007/07/19</td> <td>Thank you5</td> <td>Thank you1</td> <td></td> <td></td> </tr> </tbody> </table> <div style="text-align: center; margin: 5px 0;"> </div> <table border="1" style="width: 100%; border-collapse: collapse;"> <thead> <tr> <th style="background-color: #cccccc;">Occurrence</th> <th style="background-color: #cccccc;">Message</th> <th style="background-color: #cccccc;">Group</th> <th style="background-color: #cccccc;">Recovery</th> <th style="background-color: #cccccc;">Acknowledge</th> </tr> </thead> <tbody> <tr> <td>2007/07/19</td> <td>Thank you1</td> <td>Thank you1</td> <td></td> <td>2007/07/19</td> </tr> <tr style="background-color: #0000ff; color: white;"> <td>2007/07/19</td> <td>Thank you2</td> <td>Thank you1</td> <td></td> <td style="border: 2px solid red;">2007/07/19</td> </tr> <tr> <td>2007/07/19</td> <td>Thank you3</td> <td>Thank you1</td> <td></td> <td></td> </tr> <tr> <td>2007/07/19</td> <td>Thank you4</td> <td>Thank you1</td> <td></td> <td></td> </tr> <tr> <td>2007/07/19</td> <td>Thank you5</td> <td>Thank you1</td> <td></td> <td></td> </tr> </tbody> </table>	Occurrence	Message	Group	Recovery	Acknowledge	2007/07/19	Thank you1	Thank you1		2007/07/19	2007/07/19	Thank you2	Thank you1		2007/07/19	2007/07/19	Thank you3	Thank you1		2007/07/19	2007/07/19	Thank you4	Thank you1		2007/07/19	2007/07/19	Thank you5	Thank you1		2007/07/19	Occurrence	Message	Group	Recovery	Acknowledge	2007/07/19	Thank you1	Thank you1		2007/07/19	2007/07/19	Thank you2	Thank you1			2007/07/19	Thank you3	Thank you1			2007/07/19	Thank you4	Thank you1			2007/07/19	Thank you5	Thank you1			Occurrence	Message	Group	Recovery	Acknowledge	2007/07/19	Thank you1	Thank you1		2007/07/19	2007/07/19	Thank you2	Thank you1		2007/07/19	2007/07/19	Thank you3	Thank you1			2007/07/19	Thank you4	Thank you1			2007/07/19	Thank you5	Thank you1		
Occurrence	Message	Group	Recovery	Acknowledge																																																																																							
2007/07/19	Thank you1	Thank you1		2007/07/19																																																																																							
2007/07/19	Thank you2	Thank you1		2007/07/19																																																																																							
2007/07/19	Thank you3	Thank you1		2007/07/19																																																																																							
2007/07/19	Thank you4	Thank you1		2007/07/19																																																																																							
2007/07/19	Thank you5	Thank you1		2007/07/19																																																																																							
Occurrence	Message	Group	Recovery	Acknowledge																																																																																							
2007/07/19	Thank you1	Thank you1		2007/07/19																																																																																							
2007/07/19	Thank you2	Thank you1																																																																																									
2007/07/19	Thank you3	Thank you1																																																																																									
2007/07/19	Thank you4	Thank you1																																																																																									
2007/07/19	Thank you5	Thank you1																																																																																									
Occurrence	Message	Group	Recovery	Acknowledge																																																																																							
2007/07/19	Thank you1	Thank you1		2007/07/19																																																																																							
2007/07/19	Thank you2	Thank you1		2007/07/19																																																																																							
2007/07/19	Thank you3	Thank you1																																																																																									
2007/07/19	Thank you4	Thank you1																																																																																									
2007/07/19	Thank you5	Thank you1																																																																																									
Delete All Occurrence No.	Set to delete data for triggered alarms when the switch is activated.																																																																																										
Delete Occurrence No. of Selected Alarm	Set to delete selected history alarm data on the current page when the switch is activated.																																																																																										
Delete Recovered Alarm Data in Alarm Viewer Page	Set to delete all recovered data when the switch is activated.																																																																																										
Delete Recovered All Data in Alarm Viewer	Set to delete all recovered data when the switch is activated.																																																																																										
Delete Selected Recovered in Alarm Viewer	Set to delete the specified data, except for unrecovered alarm data when the switch is activated.																																																																																										
Go to History Alarm Viewer Detail	<p>When an alarm occurs, additional information related to the alarm may be required to solve the problem. In that case, a window can be invoked with information from other objects. Set this function to see detailed history alarm data when the switch is activated.</p> <p>To set the function to show detailed data:</p> <ol style="list-style-type: none"> 1. Edit the detailed Window screen. 																																																																																										

Function	Description								
	<p>2. Check the box next to Show detail window.</p> <p>3. In History Alarm Viewer, set options under Use Detailed Window Position.</p> <p>4. In the XGT panel, select an alarm, and then tap the special switch.</p> 								
<p>History Alarm Filter</p>	<p>Set to filter history alarm data and display it with the history alarm viewer object. There are five types of filters: Occurrence, Check, Restoration, Uncheck, and Unrestoration (unrestored alarms).</p> <table border="1" data-bbox="630 958 1310 1220"> <thead> <tr> <th>Type</th> <th>Description</th> </tr> </thead> <tbody> <tr> <td>Occurrence</td> <td>View the every history alarm data occurred.</td> </tr> <tr> <td>Check</td> <td>View the checked history alarm data with the special switch.</td> </tr> <tr> <td>Restoration</td> <td>View the restored history alarm data.</td> </tr> </tbody> </table> <p>Example of checked history alarm data</p> 	Type	Description	Occurrence	View the every history alarm data occurred.	Check	View the checked history alarm data with the special switch.	Restoration	View the restored history alarm data.
Type	Description								
Occurrence	View the every history alarm data occurred.								
Check	View the checked history alarm data with the special switch.								
Restoration	View the restored history alarm data.								
<p>History Alarm Viewer Line Down</p> <p>History Alarm Viewer Line up</p>	<p>Set to scroll history alarm data in the specified direction when the switch is activated.</p>								

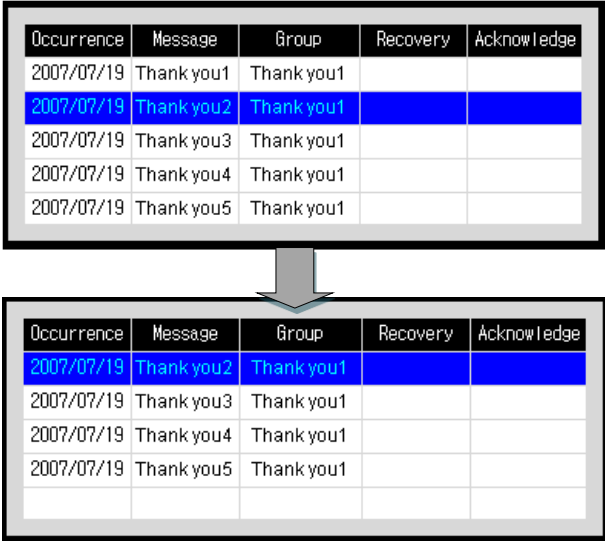
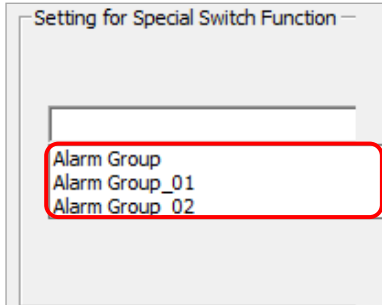
Function	Description																									
History Alarm Viewer Page Down History Alarm Viewer Page Up	 <p>The diagram illustrates the 'History Alarm Viewer Page Down' and 'Page Up' functions. It shows a table with five rows of alarm data. The second row is highlighted in blue. A downward arrow points to a zoomed-in view of that same row, showing the individual cells: Occurrence (2007/07/19), Message (Thank you2), Group (Thank you1), Recovery, and Acknowledge.</p> <table border="1" style="margin-left: auto; margin-right: auto;"> <thead> <tr> <th>Occurrence</th> <th>Message</th> <th>Group</th> <th>Recovery</th> <th>Acknowledge</th> </tr> </thead> <tbody> <tr style="background-color: #0000FF; color: white;"> <td>2007/07/19</td> <td>Thank you2</td> <td>Thank you1</td> <td></td> <td></td> </tr> <tr> <td>2007/07/19</td> <td>Thank you3</td> <td>Thank you1</td> <td></td> <td></td> </tr> <tr> <td>2007/07/19</td> <td>Thank you4</td> <td>Thank you1</td> <td></td> <td></td> </tr> <tr> <td>2007/07/19</td> <td>Thank you5</td> <td>Thank you1</td> <td></td> <td></td> </tr> </tbody> </table>	Occurrence	Message	Group	Recovery	Acknowledge	2007/07/19	Thank you2	Thank you1			2007/07/19	Thank you3	Thank you1			2007/07/19	Thank you4	Thank you1			2007/07/19	Thank you5	Thank you1		
Occurrence	Message	Group	Recovery	Acknowledge																						
2007/07/19	Thank you2	Thank you1																								
2007/07/19	Thank you3	Thank you1																								
2007/07/19	Thank you4	Thank you1																								
2007/07/19	Thank you5	Thank you1																								
Print History Alarm	Set to print the selected history alarm data when the switch is activated. An alarm group can be chosen from the history alarm list.  <p>The screenshot shows a dialog box titled 'Setting for Special Switch Function'. Inside, there is a list box containing three items: 'Alarm Group', 'Alarm Group_01', and 'Alarm Group_02'. A red rectangular box highlights the entire list box.</p>																									
Selected History Alarm Viewer Line Down	Set to change the line of the history alarm data when the switch is activated.																									
Selected History Alarm Viewer Line Up																										

- **History Alarm Row Scroll:** Set to move to the specified area of the history alarm data when the switch is activated. If the number of data columns exceeds the columns supported by the XGT panel, this function allows you to view more data.

Occurrence	Message	Group	Restoration	Ref.1	...	Ref.10
2015/12/02	Tank temp rises	1		15	...	101
2015/12/02	Line fuel shortage	3		25	...	102
2015/12/02	Pressure rises	2		80	...	180
2015/12/02	Malfunction detected	5		66	...	99

Actual history alarm data



Fixed

Unfixed



Occurrence	Message	Group	Restoration	Ref.1	Ref.2	Ref.10
2015/12/02	Tank temp rises	1		15	20	101
2015/12/02	Line fuel shortage	3		25	30	102
2015/12/02	Pressure rises	2		80	60	180
2015/12/02	Malfunction detected	5		66	80	99

History alarm data displayed on the XGT-Panel

For the history alarms data such as above, the descriptions below show how each function operates:

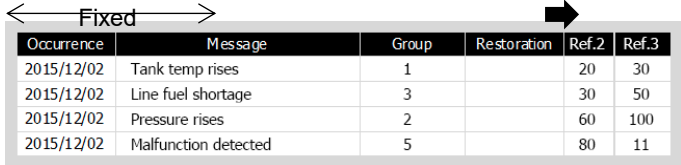
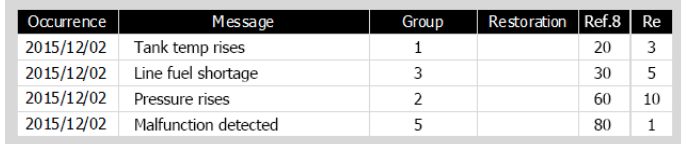
Function	Description
Next Column	<p>Use this function when there are more columns to view than are displayed on the XGT-Panel. Fixed columns retain and the next column will be displayed on the area of unfixed column.</p>  <p>History alarm data displayed on the XGT-Panel</p> <p>In the example above, data exists in the right-hand column but there is not enough area to show the all the data so some columns are displayed in part.</p> 
Pre. Column	<p>Use this function when there are more columns to view than are displayed on the XGT-Panel. Fixed columns retain and the previous column will be displayed on the area of unfixed column.</p>
First Column	<p>Among the history alarm data, the history alarm on the first column of the history alarm viewer on the XGT-Panel will be displayed.</p>
Last Column	<p>The history alarm on the last column of the history alarm viewer on the XGT-Panel will be displayed.</p>

Function	Description																														
	<table border="1"> <thead> <tr> <th>Occurrence</th> <th>Message</th> <th>Group</th> <th>Restoration</th> <th>Ref.9</th> <th>Ref.10</th> </tr> </thead> <tbody> <tr> <td>2015/12/02</td> <td>Tank temp rises</td> <td>1</td> <td></td> <td>8</td> <td>101</td> </tr> <tr> <td>2015/12/02</td> <td>Line fuel shortage</td> <td>3</td> <td></td> <td>200</td> <td>102</td> </tr> <tr> <td>2015/12/02</td> <td>Pressure rises</td> <td>2</td> <td></td> <td>13</td> <td>103</td> </tr> <tr> <td>2015/12/02</td> <td>Malfunction detected</td> <td>5</td> <td></td> <td>240</td> <td>104</td> </tr> </tbody> </table> <p>If the total object area is greater than the width of the columns, the part that exceeds the width of the columns is shown in gray.</p>	Occurrence	Message	Group	Restoration	Ref.9	Ref.10	2015/12/02	Tank temp rises	1		8	101	2015/12/02	Line fuel shortage	3		200	102	2015/12/02	Pressure rises	2		13	103	2015/12/02	Malfunction detected	5		240	104
Occurrence	Message	Group	Restoration	Ref.9	Ref.10																										
2015/12/02	Tank temp rises	1		8	101																										
2015/12/02	Line fuel shortage	3		200	102																										
2015/12/02	Pressure rises	2		13	103																										
2015/12/02	Malfunction detected	5		240	104																										

- Logging Viewer

Function	Description
Logging Viewer Line Down	Set to scroll logging data up or down when the switch is activated.
Logging Viewer Line Up	
Logging Viewer Page Down	
Logging Viewer Page Up	

- Logging Row Scroll

Function	Description																				
First Column	<p>Set to move to the specified area of the logging data when the switch is activated. If the number of data columns exceeds the columns supported by the XGT panel, this function allows you to view more data.</p> <p>As the following example illustrates, fixed columns never move, but the unfixed areas can be moved, so that you can view more data.</p> <div style="text-align: center;"> </div> <table border="1"> <thead> <tr> <th>Time</th> <th>Location</th> <th>Process 3</th> <th>Process 4</th> </tr> </thead> <tbody> <tr> <td>2013/03/29</td> <td>Line 1</td> <td>21</td> <td>31</td> </tr> <tr> <td>2013/03/30</td> <td>Line 2</td> <td>22</td> <td>32</td> </tr> <tr> <td>2013/03/31</td> <td>Line 3</td> <td>23</td> <td>33</td> </tr> <tr> <td>2013/04/01</td> <td>Line 4</td> <td>24</td> <td>34</td> </tr> </tbody> </table> <p>If the total object area is greater than the width of the columns, the part that exceeds the width of the columns is shown in gray.</p>	Time	Location	Process 3	Process 4	2013/03/29	Line 1	21	31	2013/03/30	Line 2	22	32	2013/03/31	Line 3	23	33	2013/04/01	Line 4	24	34
Time		Location	Process 3	Process 4																	
2013/03/29		Line 1	21	31																	
2013/03/30		Line 2	22	32																	
2013/03/31		Line 3	23	33																	
2013/04/01		Line 4	24	34																	
Last Column																					
Next Column																					
Previous Column																					
Next Page																					
Previous Page																					

- Alarm Navigator

Function	Description
Alarm Navigator Viewer Line Down	Set to move up or down a line in the alarm search results when the switch is activated.

Function	Description
Alarm Navigator Viewer Line Up	

- Logging Trend

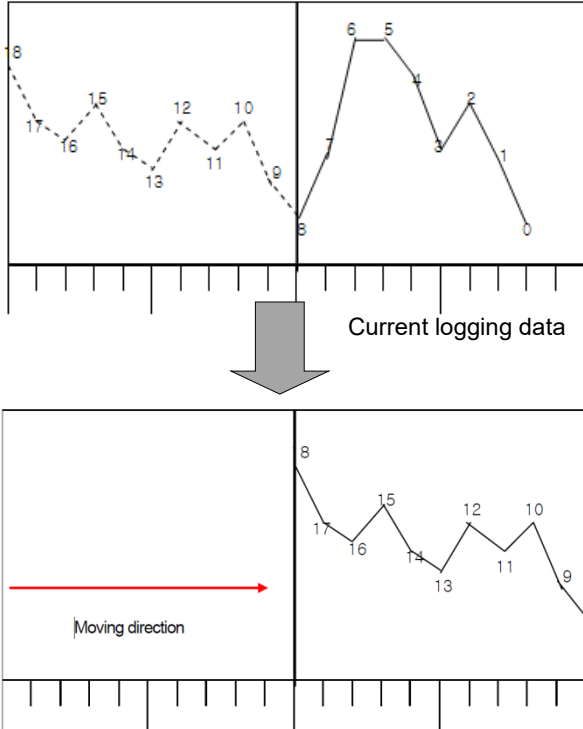
Function	Description
Next Log Trend Data	<p>View the next log. You can set the number of logs to display. For example, if the number is set to “8”, the graph will display the trend for the next eight logs.</p> 
Previous Log Trend Data	<p>View the previous log. You can set the number of logs to display. For example, if the number is set to “8”, the graph will display the trend for the previous eight logs.</p>
The First Log Trend Data	<p>View the first or last logged data.</p>
The Last Log Trend Data	
BookMark Set/Reset	<p>This function sets the user’s specified data area in the logging trend graph as a bookmark. The data areas in the graph can be navigated freely and have access to return to the bookmarked location. For example, two bookmarks can be set as shown below.</p>

Function	Description
	<div data-bbox="582 347 1316 683"> </div> <p data-bbox="582 705 1377 873">After the bookmarks are set, the user can navigate the graph to the area enclosed by dotted lines in the graph below. Then, the user can return to the area enclosed by the solid lines (Bookmark1) by clicking the Bookmark special switch.</p> <div data-bbox="750 884 1204 1220"> </div> <p data-bbox="561 1243 1377 1310">Dotted line: Indicates an area on the logging trend before moving to the bookmark.</p> <p data-bbox="561 1310 1377 1377">Solid line: Indicates an area on the logging trend after moving to Bookmark1.</p> <ol data-bbox="582 1388 1377 1856" style="list-style-type: none"> 1. A maximum of five bookmarks can be selected. 2. If more than five bookmarks are selected, the oldest bookmark is deleted. 3. If the [Bookmark setting/release] button is clicked while a bookmarked logging data set is displayed, the bookmark is released. 4. If the previous data set is deleted after the logging area reaches its full capacity with [Use cycling buffer in storage area], the data set and its bookmark are deleted. 5. If a bookmarked data set is displayed in the graph area, the bookmark is indicated in the zero position as shown in the screenshot below.

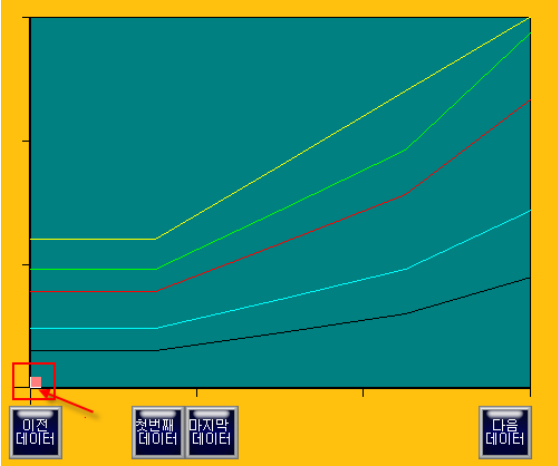
Function	Description
	
Go to BookMark	<p>This function enables the user to navigate to a bookmarked position.</p> <ol style="list-style-type: none"> 1. When the [BookMark] special switch is clicked for the first time, the graph area moves to the oldest bookmarked position. Bookmarked positions cycle sequentially in chronological order from oldest to the most recent. 2. When the most recent bookmarked position is displayed, the oldest bookmarked position is the next screenshot to be displayed in the cycle. 3. Even if current logging data is generated when the graph area moves to a bookmarked position, the current logging data is not displayed in the graph area. The user must move to the latest logging area by selecting [Last Log Trend Data] or [Next Log Trend Data].

- Memo

Function	Description
Change Memo Mode	Set to switch the memo mode when the switch is activated. In active mode, memo input is allowed. In non-active mode, only memo viewing is allowed. When switching from active to non-active mode, any unsaved memo inputs are discarded. Then, the first saved memo is displayed.
Delete All Memo	Set to delete all or selected memos. The third bit of the memo pad status device indicates whether or not the memos were deleted successfully.
Delete Memo	
Next Memo Previous Memo	Set to move to the next or previous memo when the switch is activated.
Pen Setting	Set the color and thickness of the pen to be used for memos. You can also set a special switch to apply the color and line thickness you specify.
Redo Memo	Set to restore a recently canceled memo when the switch is activated.
Reset Memo	Set to delete all memo files from storage devices when the switch is activated. The third bit of the memo pad status device indicates whether or not the memos were deleted successfully.
Save Memo	Set to save memos in a storage location when the switch is activated. The storage location must be designated in [Common] ► [Project Property Setting] ► [Storage Settings].
Undo Memo	Set to undo the last action in a memo when the switch is activated.

– Explorer and Editor: Data List Editor

Function	Description
Line Up	Press this button to view the line directly above the currently selected line.
Line Down	Press this button to view the line directly below the currently selected line.
Page Up	If the number of files or folders displayed in the list on the XGT Panel's screen exceeds the maximum limit, the files and the folder lists are created on multiple pages. Press this button to view the previous page in the file or folder list.
Page Down	If the number of files or folders displayed in the list on the XGT Panel's screen exceeds the maximum number, the files and the folder lists are created on multiple pages. Press this button to view the next page in the file or folder list.

– Explorer and Editor: Extended File Recipe

Function	Description
Transfer from PLC->XP	Press this button to transfer Extended file recipes in the PLC to XP-Builder.
Transfer from XP->PLC	Press this button to transfer Extended file recipes in XP-Builder to the PLC.
Line Up	Press this button to view the folder or file in the line directly above the currently selected folder or file.
Line Down	Press this button to view the folder or file in the line directly below the currently selected folder or file.
Page Up	If the number of files or folders displayed in the list on the XGT Panel's screen exceeds the maximum number, the files and the folder lists are created on multiple pages. Press this button to view the previous page in the file or folder list.
Page Down	If the number of files or folders displayed in the list on the XGT Panel's screen exceeds the maximum number limit, the files and the folder lists are created on multiple pages. Press this button to view the next page in the file or folder list.
Show the Selected File	Press this button to show the recipe data of the selected item on the Extended file recipe editor when the user selects a certain item from the Extended file recipe list displayed on Recipe Explorer.

– Explorer and Editor: File Explorer

Function	Description
----------	-------------

Function	Description
Line Up	Press this button to view the folder or file in the line directly above the currently selected folder or file.
Line Down	Press this button to view the folder or file in the line directly below the currently selected folder or file.
Page Up	If the number of files or folders displayed in the list on the XGT Panel's screen exceeds the maximum limit, the files and the folder lists are created on multiple pages. Press this button to view the previous page in the file or folder list.
Page Down	If the number of files or folders displayed in the list on the XGT Panel's screen exceeds the maximum limit, the files and the folder lists are created on multiple pages. Press this button to view the next page in the file or folder list.
Copy	Cut a selected file or folder from File Explorer.
Cut	Cut a selected file or folder from File Explorer.
Paste	Paste a selected file or folder from File Explorer in a selected folder. If there is a file or folder with the same name, "copy_" is prefixed to the copied file or folder.
Delete	Delete a selected file or folder from File Explorer. When a folder is deleted, all files in the folder are also deleted.
Select All	Select all valid files in a selected File Explorer folder.
Execute	Opens the files in the registered video player or the recipe editor when the video or the CSV files are selected.
Cancel	Cancels the selection of a file or folder from File Explorer.
Go Up to Directory	Moves to the parent directory of the currently selected file or folder.
Go to Root Directory	Moves to the root directory of the current storage device.
Favorites	Moves to a bookmark set by the user.
Restoration of Basic Recipe Backup files	Restores the basic recipe data. The data is read from the recipe backup file in File Explorer that is specified by the user. A recipe backup file is a CSV file saved in a storage device when the basic recipe backup device is set to "on". The basic recipe data cannot be restored if the basic recipe setting is changed after the backup file is created, or if the backup file is created in another project.
Write selected file name in to the device	File name device: Write selected file name in the file explorer on the device. Write path and file name on the device. Device length: Designate byte size including path and file name. 1 character is 2 bytes.

Function	Description
	For example, the selected file name is abc.csv. Designate HW0000 as device and 14 bytes as byte. Then the value of abc.csv is saved to HW0000.
Copy to specified path	<p>Specify the path to copy: If the feature is not set, copy and paste the selected file in the file explorer. If the feature is set, copy and paste to the specified path regardless of whether the file explorer exists and its status.</p> <p>Path to copy: Set a file/path to copy: Copy and paste the copied file to the set path. If the path is not set, copy and paste to the file path selected in the file explorer.</p> <p>Include Path (Full Path): Specify whether to include the path when saving the selected file name on the device. For example, if the selected file name and path is FlashDisk \\ abc.csv.</p> <p>Checked Include path: FlashDisk\\abc.csv Unchecked Include path: abc.csv</p>

– **Explorer and Editor: File Recipe Editor**

Function	Description
Line Up	Press this button to view the folder or file in the line directly above the currently selected folder or file.
Line Down	Press this button to view the folder or file in the line directly below the currently selected folder or file.
Page Up	If the number of files or folders displayed in the list on the XGT Panel's screen exceeds the maximum limit, the files and the folder lists are created on multiple pages. Press this button to view the previous page in the file or folder list.
Page Down	If the number of files or folders displayed in the list on the XGT Panel's screen exceeds the maximum limit, the files and the folder lists are created on multiple pages. Press this button to view the next page in the file or folder list.
Storage	Save the data of the file recipe editor that is currently displayed on the XGT-Panel to the file selected in Recipe Explorer.

– **Explorer and Editor: File Recipe Explorer and Transfer**

Function	Description
Transfer from PLC->XP	Press this button to transfer file recipes in the PLC to XP-Builder.
Transfer from XP->PLC	Press this button to transfer file recipes in XP-Builder to the PLC.

Function	Description
Line Up	Press this button to view the folder or file in the line directly above the currently selected folder or file.
Line Down	Press this button to view the folder or file in the line directly below the currently selected folder or file.
Page Up	If the number of files or folders displayed in the list on the XGT Panel's screen exceeds the maximum number, the files and the folder lists are created on multiple pages. Press this button to view the previous page in the file or folder list.
Page Down	If the number of files or folders displayed in the list on the XGT Panel's screen exceeds the maximum number limit, the files and the folder lists are created on multiple pages. Press this button to view the next page in the file or folder list.
Show the Selected File	Press this button to show the recipe data of the selected item on the file recipe editor when the user selects a certain item from the file recipe list displayed on Recipe Explorer.

– Explorer and Editor: General Recipe Explorer and Transfer

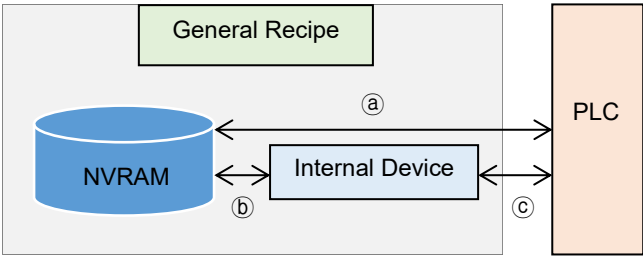
Function	Description
Line Up	Press this button to view the folder or file in the line directly above the currently selected folder or file.
Line Down	Press this button to view the folder or file in the line directly below the currently selected folder or file.
Transfer from PLC->XP Transfer from XP->PLC	<p>Press these buttons to transfer recipes from one device to another.</p> <p>When the basic recipe edited in XP-Builder is transferred to the XGT Panel, it will be backed up in the NVRAM. The diagram below shows how recipes are transferred between the NVRAM, an internal device and PLC.</p>  <p>When a special switch is set to Transfer from NVRAM to PLC, recipe is transferred in the direction ① described in the illustration above.</p> <p><u>To do this:</u></p> <ol style="list-style-type: none"> 1. Select a recipe item to transfer from Recipe Explorer. 2. Press the special switch for transferring from NVRAM to PLC.

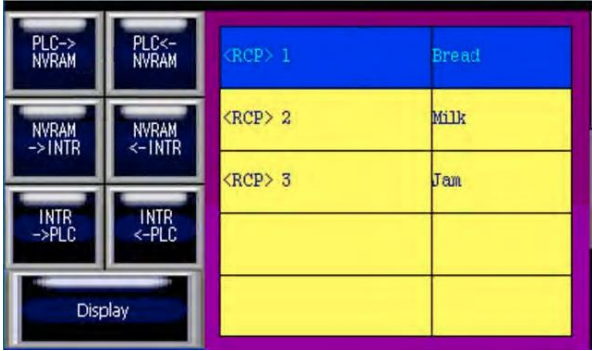
Function	Description
	 <p>The diagram shows a control panel with several buttons and a data list. On the left, there are six buttons arranged in a 3x2 grid: 'PLC->NVRAM', 'PLC<-NVRAM', 'NVRAM->INTR', 'NVRAM<-INTR', 'INTR->PLC', and 'INTR<-PLC'. Below these is a 'Display' button. To the right is a data list with three columns: '<RCP>', 'ID', and 'Name'. The first row is highlighted in blue and contains '<RCP> 1', 'Bread', and an empty cell. The second row is highlighted in yellow and contains '<RCP> 2', 'Milk', and an empty cell. The third row is highlighted in yellow and contains '<RCP> 3', 'Jam', and an empty cell. A purple border surrounds the data list area.</p>
<p>Transfer from PLC to NVRAM</p>	<p>When a special switch is set to Transfer from PLC to NVRAM, a recipe is transferred in the direction labeled ① as shown in the diagram above.</p> <p><u>To do this:</u></p> <ol style="list-style-type: none"> 1. Select a recipe item. 2. Press the special switch for transferring from a PLC to the NVRAM. 3. A basic recipe from a PLC moves to the NVRAM allocated in the recipe.
<p>Transfer from NVRAM to Internal Device</p>	<p>When a special switch is set to Transfer from NVRAM to Internal Device, recipe is transferred in the direction labeled ② as shown in the diagram above.</p> <p>In order to edit the basic recipe backed up in the NVRAM, the recipe saved in the NVRAM should be moved to the internal device. Therefore, it should be moved to the internal device to edit the data and the address of the internal device to move can be set in the internal device of the recipe editor.</p>
<p>Transfer from Internal Device to NVRAM</p>	<p>When a special switch is set to Transfer from Internal Device to NVRAM, a recipe is transferred in the direction labeled ③ as shown in the diagram above.</p> <p>A basic recipe edited in the internal device is moved to the NVRAM.</p>
<p>Transfer from Internal Device to PLC</p>	<p>When a special switch is set to Transfer from Internal Device to PLC, a recipe is transferred in the direction labeled ④ as shown in the diagram above.</p>
<p>Transfer from PLC to Internal Device</p>	<p>When a special switch is set to Transfer from PLC to Internal Device, a recipe is transferred in the direction labeled ⑤ as shown in the diagram above.</p>
<p>Show the Selected Recipe</p>	<p>Shows a selected recipe on the data list editor.</p>

- **Multimedia**

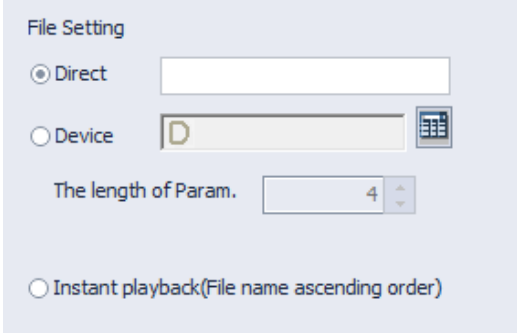
Function	Description
Play	 <p>The screenshot shows a 'File Setting' dialog box with three radio buttons: 'Direct', 'Device', and 'Instant playback (File name ascending order)'. The 'Direct' option is selected. There is a text input field for 'Direct', a device selection dropdown for 'Device' (showing 'D'), and a spinner control for 'The length of Param.' set to '4'.</p> <p>Direct: Enter file name. There is no need to enter the extension of the video file Device: Set a device to enter the file name. Play: Play in ascending order based on the file name. You can play video files with the extension type of MP4, AVI, and WMV.,</p>
Stop	Stops the video file being played.
Pause / Restart	Pauses the video file being played and restarts it.
Fast Forward	Moves forward by the set time.
Backward	Moves backward by the set time.
Next file	Plays the next file in ascending order based on the file name.
Previous file	Play previous file in ascending order based on the file name.

- **PDF Viewer**

Function	Description
File Open	<p>The selected PDF file is displayed in the PDF file view object. The file can be selected by manually entering the file name or by reading the file name set in the device.</p> <p>If /# (number) is entered after the file name, the specified page number is displayed when the PDF viewer runs. For example, USB Storage\LS.pdf/#5 will display page 5 of the LS.pdf file at first.</p> <p>Manual setting: The name of the PDF file to be displayed is manually entered. Device setting: The value of the parameter length (byte unit) is read from the specified device to use as the PDF file name.</p>

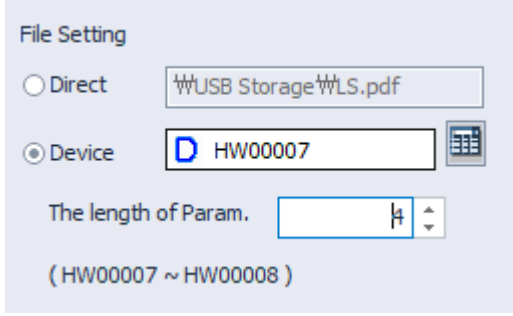
Function	Description
	
File Close	Closes the file displayed in the PDF file view object.
Zoom In	Zooms in on the file displayed in the PDF file view object.
Zoom Out	Zooms out of the file displayed in the PDF file view object.
Anticlockwise Rotation	Rotates the view of the file displayed in the PDF file view object 90° in a counterclockwise direction.
Clockwise Rotation	Rotates the view of the file displayed in the PDF file view object 90° in a clockwise direction.
Previous Page	Displays the previous page in the currently open file in the PDF file view object. If there is no previous page, the current page is displayed.
Next Page	Displays the next page in the currently open file in the PDF file view object. If there is no next page, the current page is displayed.
First Page	Displays the first page in the currently open file in the PDF file view object.
Last Page	Displays the last page in the currently open file in the PDF file view object.

– VNC Viewer

Function	Description
Zoon In	Zooms in on the viewer screen.
Zoom Out	Zoom out of the viewer screen.
Start	Begins a virtual network computing session.
Stop	Ends the current virtual network computing session.

– ETC

Function	Description
Change Runtime	Set to change the runtime language when the switch is activated.

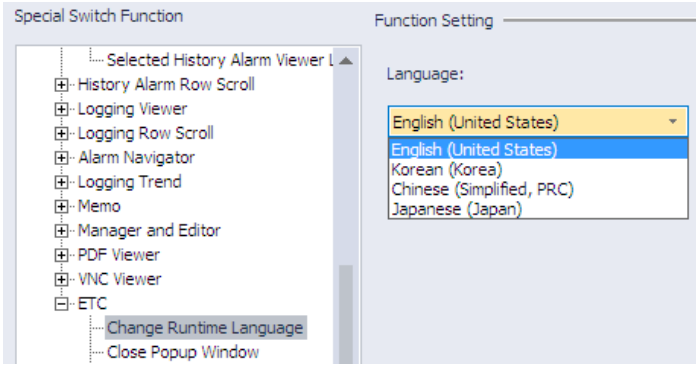
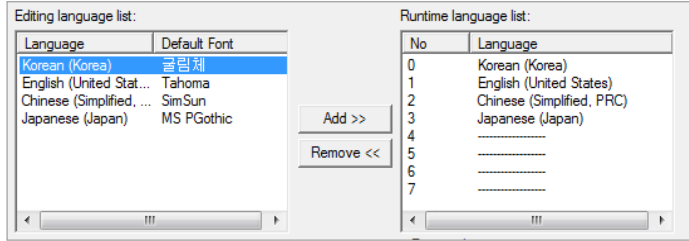
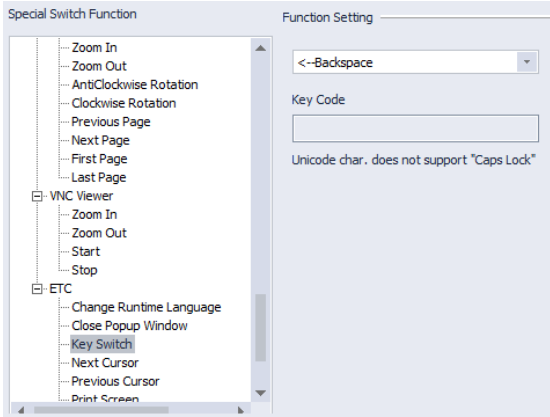
Function	Description
<p>Language</p>	<p>Select a language in the Function Setting field.</p>  <p>You can specify runtime languages in the project properties. Click [Common] ► [Project Property Setting] ► [Language] and edit the available runtime language.</p> 
<p>Close Window</p>	<p>Place it on the window screen and touch it during monitoring to close the window screen. It operates when placed on the window connected to the bit window object, the history alarm detail window, and the keypad window screen. It does not work on the window connected to the word window object.</p>
<p>Key Switch</p>	<p>Set to open an input window when the switch is activated. Select the function in the Function Setting field, and set a key code if necessary.</p>  <p>You can apply text, numbers, or special functions (clear, space, enter, caps lock, and more). When you select the special switch in the XGT Panel, the key code is entered into the numeric or text input device.</p> <p>If an ASCII character or Unicode character is selected, a user can input only one text value.</p>

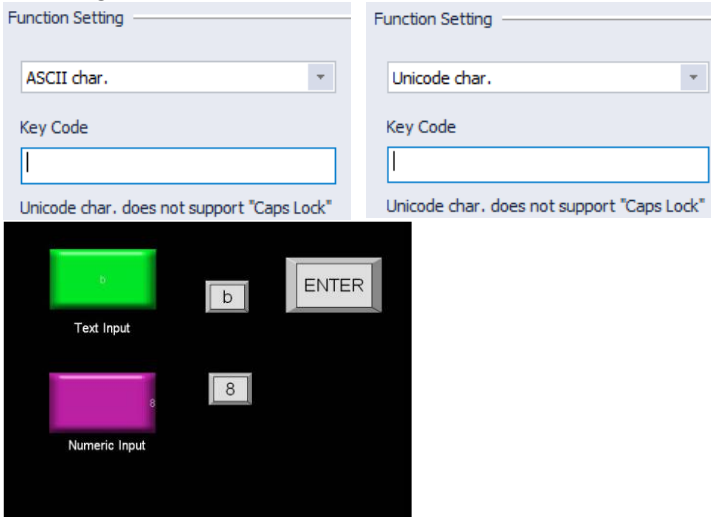
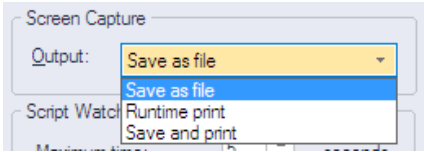
Function	Description						
	<p>To use uppercase characters, users can enter the text value by entering uppercase characters.</p>  <p>Note</p> <p>To enter uppercase characters:</p> <ul style="list-style-type: none"> • ASCII: You cannot input uppercase characters directly. To input uppercase characters, turn on the caps lock switch and the letter input switch (A= the caps lock switch + the “a” input switch). • UNICODE: Set the uppercase characters in advance. You need only one switch. 						
Next Cursor	Set to move the cursor in numeric or text input objects to the next or previous field.						
Previous Cursor							
Print Screen	<p>Set to print a screen capture of the XGT Panel when the switch is activated. The file can be printed to a file or to a printer, as specified in the project properties. To set the properties, click [Common] ► [Project Property Setting] ► [Auxiliary Settings] and set a print option from the Output drop-down list under Screen Capture:</p>  <table border="1" data-bbox="616 1760 1334 2024"> <thead> <tr> <th>Option</th> <th>Description</th> </tr> </thead> <tbody> <tr> <td>Save <input type="checkbox"/> as File</td> <td>Save the image as a Bitmap file. You can set the file path in [Common] ► [Project Property Setting] ► [Storage Setting] ► [Capture image].</td> </tr> <tr> <td>Runtime print</td> <td>Print a screenshot with a printer connected via USB.</td> </tr> </tbody> </table>	Option	Description	Save <input type="checkbox"/> as File	Save the image as a Bitmap file. You can set the file path in [Common] ► [Project Property Setting] ► [Storage Setting] ► [Capture image].	Runtime print	Print a screenshot with a printer connected via USB.
Option	Description						
Save <input type="checkbox"/> as File	Save the image as a Bitmap file. You can set the file path in [Common] ► [Project Property Setting] ► [Storage Setting] ► [Capture image].						
Runtime print	Print a screenshot with a printer connected via USB.						

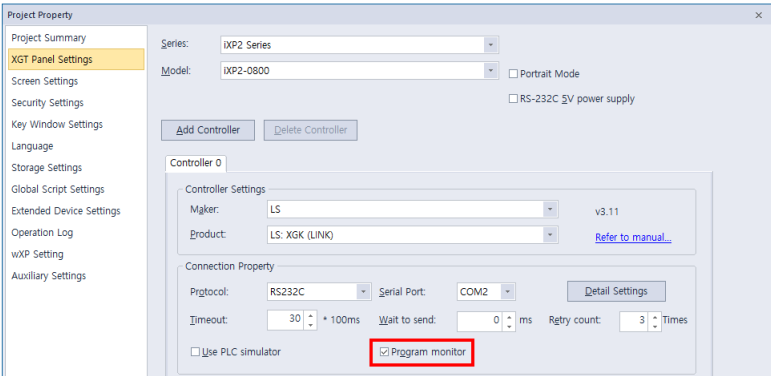
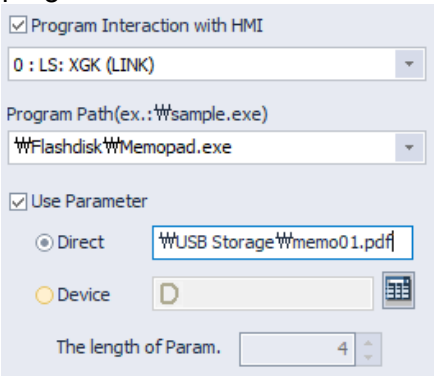
Function	Description
<p>Program Monitoring</p>	<p>Save and Print</p> <p>Save an image as a file and print it with a printer connected via USB. If a printer is not connected to the XGT Panel, a system alarm will occur. When the user connects the printer again and attempts to print, the system alarm will be restored. To set the system alarm, click [Common] ▶ [Project Property Setting] ▶ [Auxiliary Settings] and check the checkbox next to Alarm window pop-up.</p> 
	<p>Set to launch the program monitor when the switch is activated. To run the program monitor, use the XGT, XGI, or XGB series. Specify the program monitor settings in the project properties. Click [Common] ▶ [Project Property Setting] ▶ [XGT Panel Settings] ▶ [Program monitor].</p> 
<p>Run Other Application</p>	<p>This function runs an application program set in the program path. For example, the command, Memopad.exe runs the Memopad program from the “Flashdisk” folder using the following settings.</p>  <ul style="list-style-type: none"> • Program interaction with HMI: Select a controller to interact with when using program monitoring.

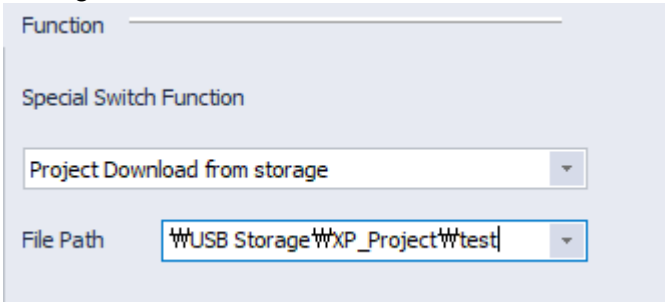
Function	Description				
	<ul style="list-style-type: none"> • Program Path: Set a path for the program file to execute. • Use parameter: Set the transfer factor to be used as the parameter of the program when an application program, set in the program path, is run. For example, if PDF Viewer is set as the external application program, as shown in the screenshot below, the pdf file, set as the parameter in the file path, is opened by the PDF viewer. Some application programs may not support spaces (ASCII code: Space) in the parameter values. 				
Runtime Exit	Set to quit program monitoring when the switch is activated.				
Safe Removal Switch	<p>The safe removal switch performs the same function as the safe hardware removal switch. Click the safe removal switch and the storage unit (SD) detaches when the current operation is completed.</p> <p>The special device address for the sensor that detects that the storage device has detached is contained in the following table.</p> <table border="1" data-bbox="576 927 1374 1014"> <thead> <tr> <th data-bbox="576 927 903 969">Storage Device</th> <th data-bbox="908 927 1374 969">Special Device Address</th> </tr> </thead> <tbody> <tr> <td data-bbox="576 976 903 1014">SD card</td> <td data-bbox="908 976 1374 1014">HS51.2</td> </tr> </tbody> </table> <p>This function is supported only by iXP70/80/90 models.</p>	Storage Device	Special Device Address	SD card	HS51.2
Storage Device	Special Device Address				
SD card	HS51.2				
Security mode lock	For a secured object, security is usually locked again after a certain period of time has elapsed from the time the security was disabled. This is a function to switch back to the security mode when the special switch is pressed before a certain time.				
XP-Remote	Set to enable remote monitoring of the XGT Panel. You can specify functions for obtaining and terminating authorization for remote monitoring.				
Update	<p>Download project from storage device: Updates the current XGT Panel with the project in the path set by the user. If set as below, update to the test project in the XP_Project folder of USB Storage.</p> 				

- **Display:** The display settings for special switch objects include the following.

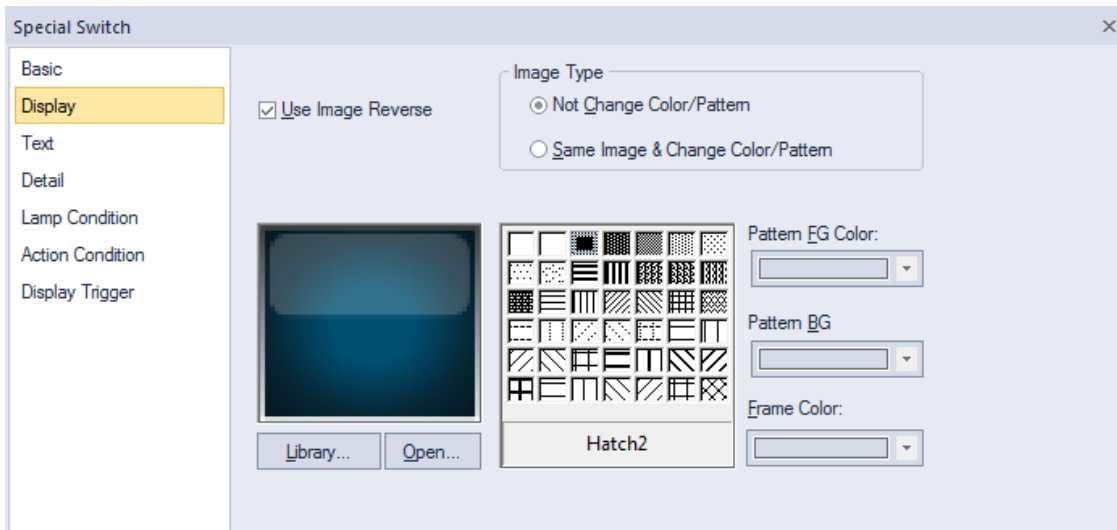

- **Transparent BG Image:** Check the checkbox to make the image background transparent. You cannot use a transparent background and the reverse image setting at the same time.
- **Use Image Reverse:** The switch image is reversed when you tap the object or a condition is met. If you set this option, you cannot use the **Transparent BG Image** option or the On/Off image. If you set the **Transparent BG Image** option, you cannot use this option.
- **On:** Click to configure options for the object in the “On” state.
- **Off:** Click to configure options for the object in the “Off” state.
- **Off->On Copy:** Copies all image properties in the Off state to On.
- **On->Off Copy:** Copies all image properties in On status to Off.
- **Image Type:** Set whether or not to change colors and patterns when switching between “On” and “Off” states. If you select the change color or pattern option, you must select a vector image for the object. To view characteristics of raster or vector images, refer to **<2.4.1 Managing Graphic Libraries>**.

Not Change Color/Pattern	Use the original image. You can apply the pattern or color to the image. Select the image to display for the “On” or “Off” states from raster, vector, or user registered images.
Same Image & Change Color/Pattern in On/Off	Select a vector image. You cannot select a raster image. Apply a pattern or color to the image.

- **Library:** Click to select an image from the library.
- **Open:** Click to browse images on your computer. When you select an image from your computer, it will be added to the image library automatically.
- **Pattern:** Click a pattern to apply to the image. This option is available only when you select the change color or pattern option in **Image Type**. Patterns are applied to specific parts of objects, but not to the frames. The frames are different for each image. Refer to the screenshots below.

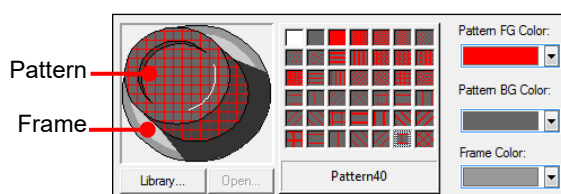

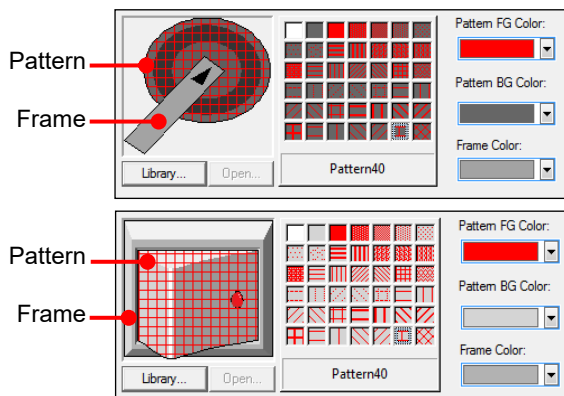

- **Pattern FG Color:** Select a color for the foreground pattern.
- **Pattern BG Color:** Select a color for the background pattern.
- **Frame Color:** Select a frame color.

- **Text:** The text settings for special switch objects are shown in the screenshot below.

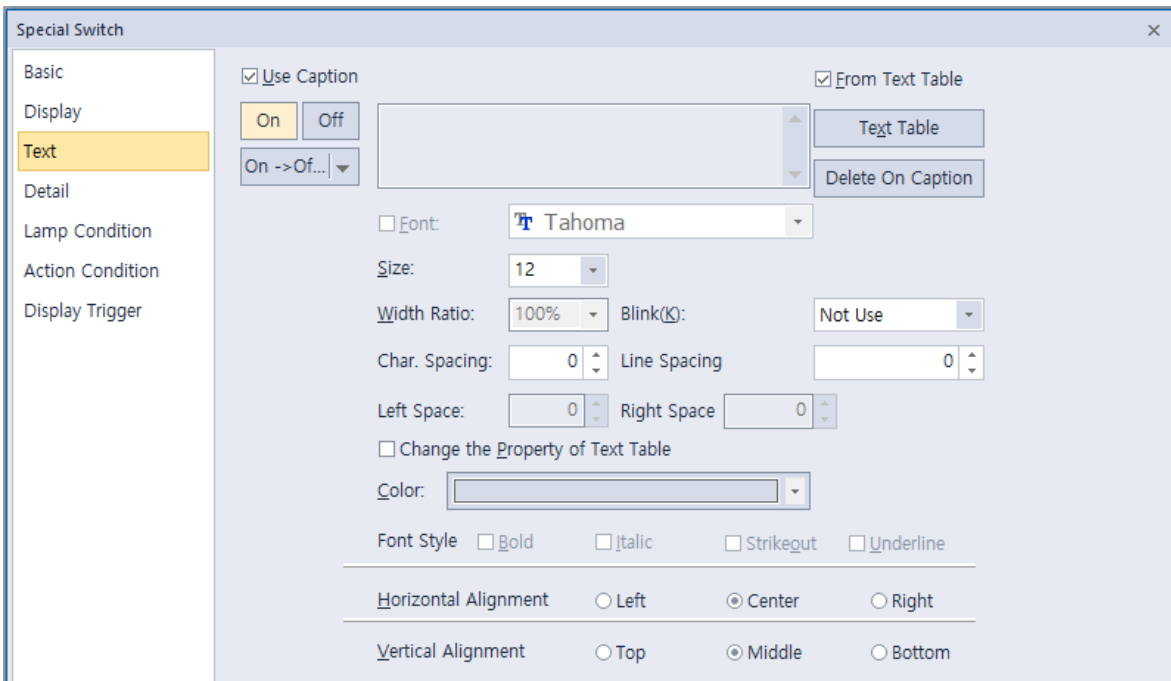

- **Use Caption:** Check the checkbox to use a text caption with the object. When you select this option, you can input text from a text table.
- **On:** Click to configure options for the object in the “On” state. You must input the text in a text table.
- **Off:** Click to configure options for the object in the “Off” state. You must input the text in a text table.
- **From Text Table:** Check the checkbox to add text from a text table. The Text Table option will be activated and the text input area will close. Add the required text to the text table before editing the object. You must select text for the “On” and “Off” states from the same text table.
- **Text Table:** Click to open the text table and select text. The color and font properties set in the text table will be imported with the text.

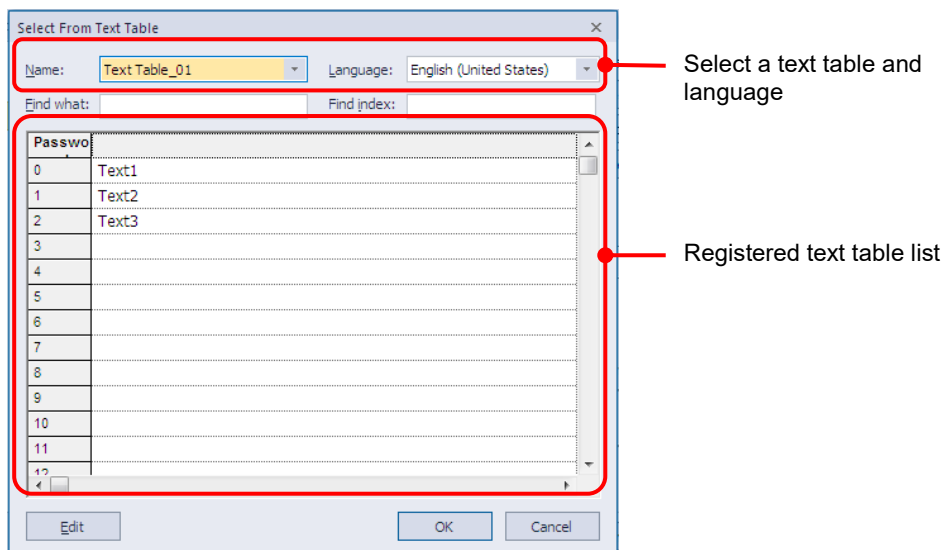

- **On <-> Off Copy:** Click to copy the text and formatting from the “On” state to the “Off” state or vice versa.
- **Copy Only Caption:** You can open the dropdown menu next to [On -> Off] to select [Copy Only Caption]. This feature allows you to copy only the currently selected text string to another state.

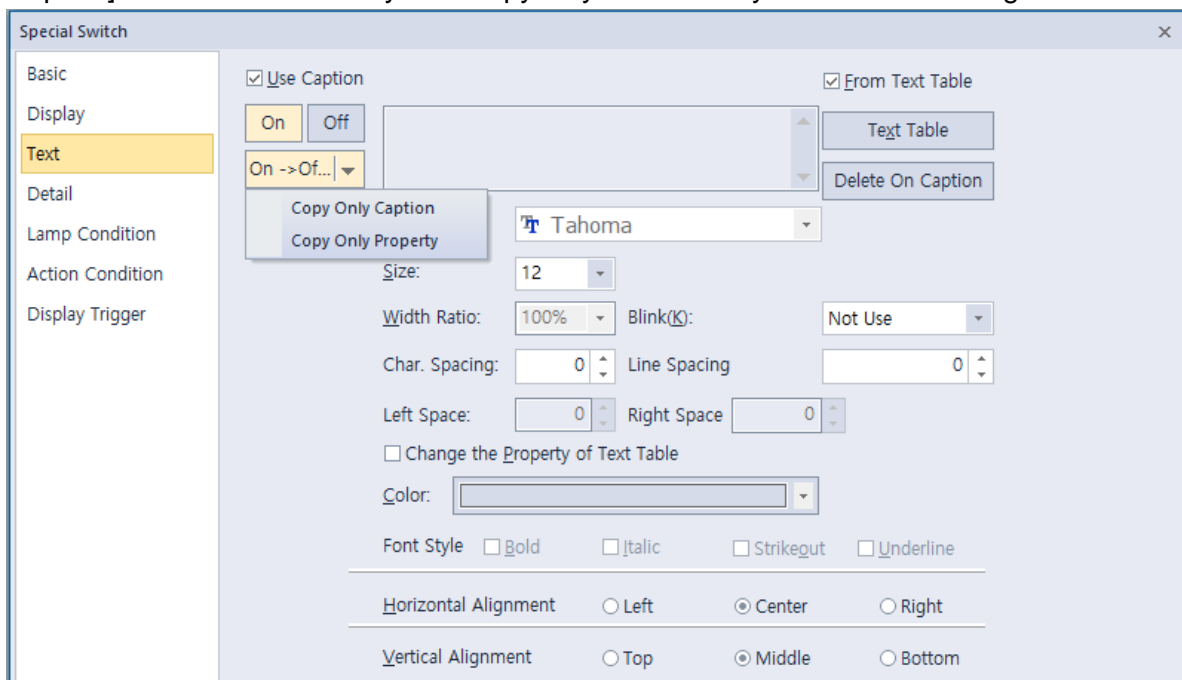

- **Copy Only Property:** You can open the dropdown menu next to [On -> Off] to select [Copy Only Property]. This feature allows you to copy all properties except the currently selected text string are copied to another state.
- **Delete On/Off Caption:** Click to clear text settings for the current state.
- **Font:** Select a font from the drop-down list.
- **Size:** Select a text size from the drop-down list or enter a value directly into the field.
- **Width Ratio:** Expand or condense the text by selecting a ratio from the drop-down list or entering a value directly into the field. You can set a ratio of 1%-600%.
- **Blink:** Set the blink speed for the caption.
XP30-BTE, XP30-TTE, XP40-TTE, and XP50-TTE are not supported.

Not use	The caption will not blink.
Slow	The caption will blink every three seconds.
Normal	The caption will blink every two seconds.
Fast	The caption will blink every second.

- **Space:** Set the space on the object. If you select Left align in Horizontal Alignment, you can set the left space, and if you select Right Align, you can set the right space.
- **Char. Spacing: Set text** intervals. If the value is a negative number, the spacing will decrease and if the value is a very small negative number, it can be overlaid or have the same effect as a positive number.
- **Line. Spacing: Set line** spacing. If the value is a negative number, the spacing will decrease, and if the value is a very small negative number, it can be overlaid of have the same effect as a positive number.
- **Change the Property of Text Table:** Click to copy different color and font properties to the text than those specified in the text table. This option is active only when you fetch text from the text table.
- **Color:** Select a font color.
- **Font Style:** Select a font style (bold, italic, strikeout, or underline). You can apply more than one option at a time.
- **Horizontal Alignment:** Set the horizontal alignment (left, center, or right).
- **Vertical Alignment:** Set the vertical alignment (top, middle, or bottom).

• **Detail:** The detail settings for special switch objects are shown in the screenshot below.

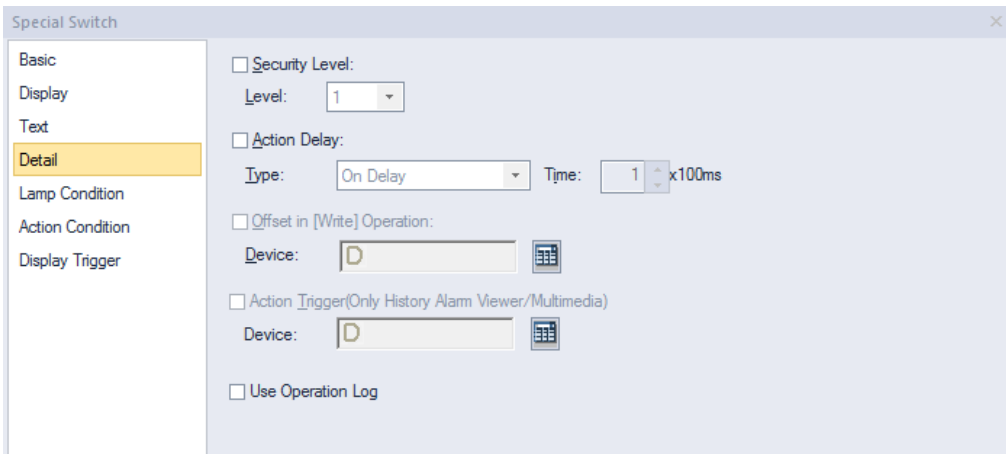

- **Security Level:** Set whether or not to require a password to use the object.
- **Level:** Set the security level for the object. The higher the security level, the shorter the authorization time when the password is entered. When the authorization time expires, the user must enter the password again to use the object.
- **Action Delay:** Set to delay the action triggered by the switch by a specified time.
- **Type:** Set the type of action delay.

On Delay	When the switch is activated, the action is performed after the delay time that you specify.
-----------------	--

Press Twice

When the switch is activated once, a dialog box is invoked to allow the user to verify the operation. When the switch is activated a second time, the action is performed after the delay time that you specify.

- **Time:** Set the length of time for the action delay.
- **Offset in [Write] Operation:** Set to use the Offset function. The special switch does not support this function.
- **Device:** Enter a device or tag address directly into the input field or click the keypad icon to the right to specify a device or tag address. When you click the keypad icon to open the Device window, you can also specify network settings, if necessary.
- **Action Trigger (Only for History Alarm Viewer/ Multimedia):** Set whether or not to use an action trigger with the history alarm viewer object and multimedia display. The Special Switch function is activated when the special switch is pressed on the XGT Panel or when the specified device is turned on.

Note

Where there are two or more “Play” switches for the same operating device when there are more than two multimedia objects on one screen (main screen/popup window/overlay window, etc.), it is not guaranteed that the video file will play at that point. Therefore, it is not recommended to use the same device for an operating device.

- **Device:** Enter a device or tag address directly into the input field or click the keypad icon to the right to specify a device or tag address. When you click the keypad icon to open the Device window, you can also specify network settings, if necessary.
- **Use Operation Log:** Set to allow the device to be monitored in an operation log. XP30-BTE, XP30-TTE, XP40-TTE, and XP50-TTE are not supported.

- **Lamp Condition:** The lamp condition settings for special switch objects are shown in the screenshot below.

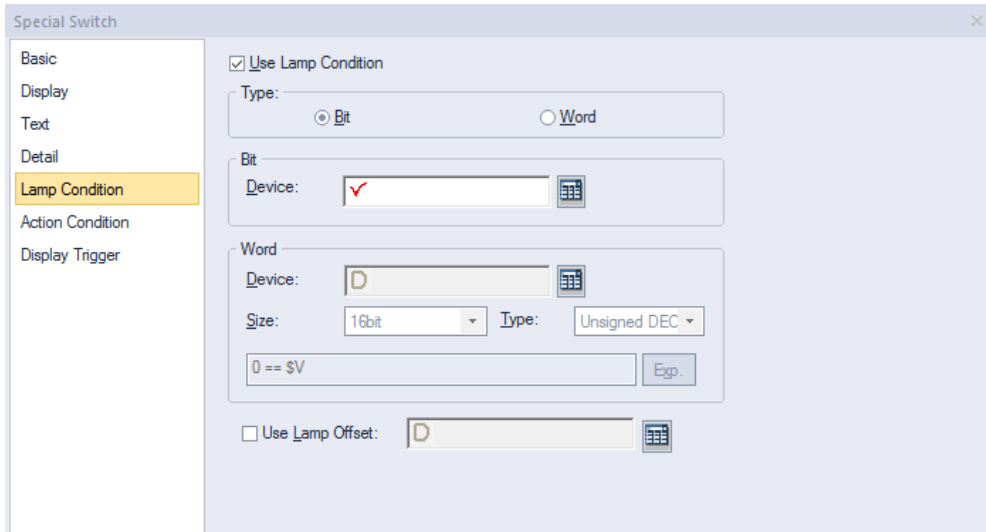

- **Use Lamp Condition:** If you want to control a lamp with a method other than simply turning it on when the switch is activated, you can select a different action.
- **Type:** Select a condition for lamp control.

Bit	When the device state is on, the lamp is on.
Word	When the condition is met, the lamp is on.

- **Bit:** If you selected the bit condition type, specify a bit device.

Device	Enter a device or tag address directly into the input field or click the keypad icon to the right to specify a device or tag address. When you click the keypad icon to open the Device window, you can also specify network settings, if necessary.
---------------	--

- **Word:** If you selected the word condition type, specify a word device.

Device	Enter a device or tag address directly into the input field or click the keypad icon to the right to specify a device or tag address. When you click the keypad icon to open the Device window, you can also specify network settings, if necessary.
Size	16-bit upper byte, 16-bit lower byte, 16-bit, or 32-bit.
Type	Signed decimal, unsigned decimal, or BCD, or float.
Exp.	Click to designate the expression as conditional.

- **Use Lamp Offset:** Click to set an offset for the lamp.

- **Action Condition:** The action condition settings for special switch objects are shown in the screenshot below.

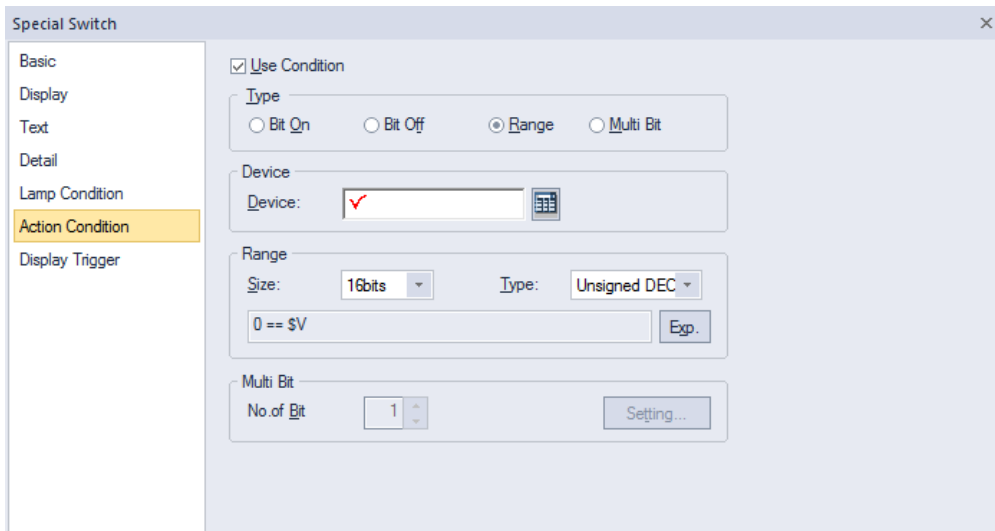

- **Use Condition:** Set whether or not to specify a condition for the action.
- **Type:** Set a type of condition to specify.

Bit On	The action is performed when the device is switched on.
Bit Off	The action is performed when the device is switched off.
Range	The action is performed when the value falls within the specified range.
Multi Bit	The action is performed when the logical operation result of multiple devices is met.

- **Device:** Enter a device or tag address directly into the input field or click the keypad icon to the right to specify a device or tag address. When you click the keypad icon to open the Device window, you can also specify network settings, if necessary.
- **Range:** If you select the range condition, specify the range.

Size	16-bit or 32-bit.
Type	Signed decimal, unsigned decimal, BCD, or float.
Exp.	Click to designate the expression as conditional.
- **Multi Bit:** If you select the multi bit condition, specify the number of bits and click [Setting] to specify the bit conditions.

- **Display Trigger:** The display trigger settings for special switch objects include the following.

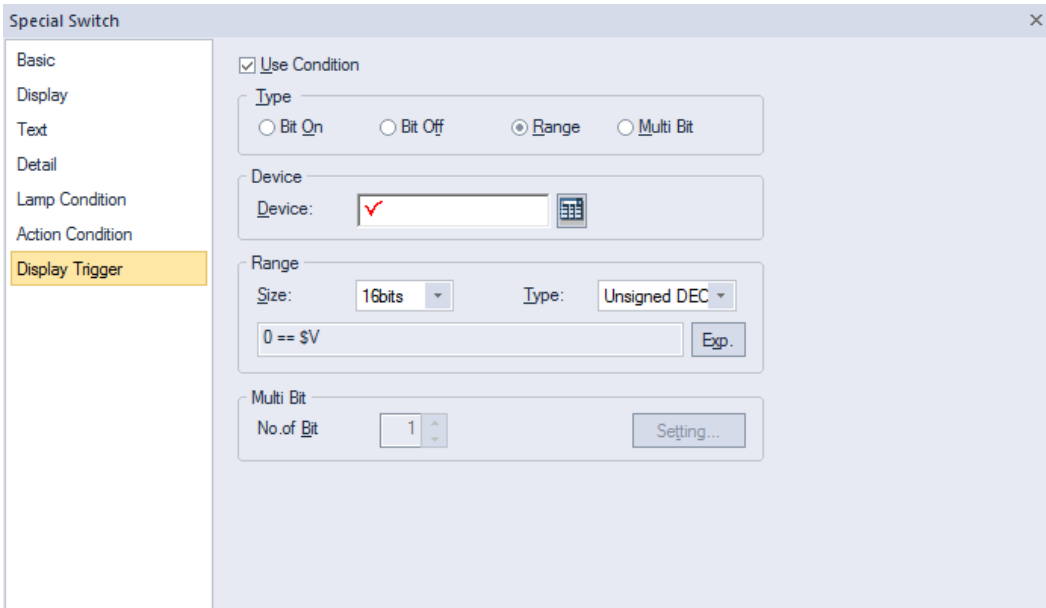

- **Use Condition:** Set whether or not to specify a condition for the display trigger.
- **Type:** Set a type of condition to specify.

Bit On	The object will display when the device is on.
Bit Off	The object will display when the device is off
Range	The object will display when the range condition of the device is satisfied.
Multi Bit	The object will display when the logical operation results of multiple device are satisfied.

- **Device:** Enter a device or tag address directly into the input field or click the keypad icon to the right to specify a device or tag address. When you click the keypad icon to open the Device window, you can also specify network settings, if necessary.
- **Range:** If you select the range condition, specify the range.

Size	16 bit or 32 bit.
Type	Signed decimal, unsigned decimal, BCD, or float.
Exp.	Click to designate the expression as conditional.

- **Multi Bit:** If you select the multi bit condition, specify the number of bits and click [Setting] to specify the bit conditions.

4.3.2.5 Multi Switch

A multi switch object is a switch that can operate a combination of functions of the bit switch, word switch, change screen switch and special switch. You can set the sequence of each operation and up to 20 functions can be carried out at a time. This section describes available settings for multi switch objects.

- **Basic:** The basic settings for multi switch objects are shown in the screenshot below.

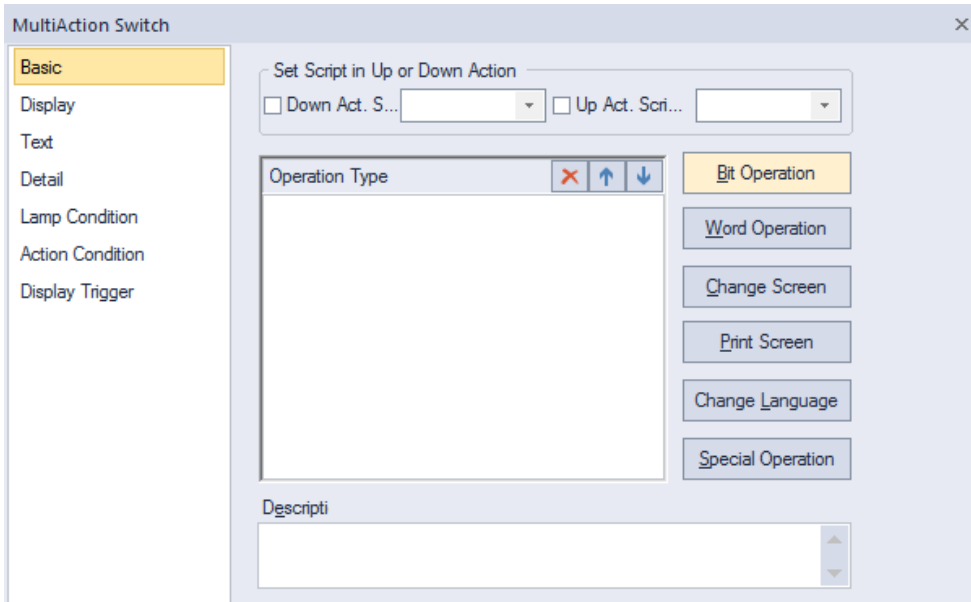

- **Set Script in Up or Down Action:** Set scripts for up or down states of the switch.

Down Act. Script	Select a script to execute when the switch is depressed.
Up Act. Script	Select a script to execute when the switch is released.

- **Operation Type:** Select and manage operations.

(Delete)	Click a condition and then click this icon to delete the condition.
(Up)	Click a condition and then click this icon to move it higher up the list.
(Down)	Click a condition and then click this icon to move it lower down the list.

- **Bit Operation:** Click to set a condition for a bit switch. For more information about bit switches, refer to [<4.3.2.1 Bit Switch>](#).
- **Word Operation:** Click to set a condition for a word switch. For more information about word switches, refer to [<4.3.2.2 Word Switch>](#).
- **Change Screen:** Click to set a condition for a screen change switch. For more information about screen change switches, refer to [<4.3.2.3 Change Screen Switch>](#)

Note

The change screen switch must be the last switch when using multiple switches. This switch will be moved to the end of the operation list automatically. This is to ensure that all the user operations on the current screen are performed before switching to another screen.

- **Print Screen:** Click to set a condition for a print screen switch. For more information about print screen switches, refer to **<4.3.2.4 Special Switch>**.
- **Change Language:** Click to set a condition for a change language switch. For more information about change language switches, refer to **<4.3.2.4 Special Switch>**.
- **Special Operation:** Click to set a condition for a special operation switch. For more information about special operation switches, refer to **<4.3.2.4 Special Switch>**.

Note

Language and screen switching operate independently, even though both are special switches.

- **Description:** Enter a description for the object.
- **Display:** The display settings for multi switch objects are shown in the screenshot below.

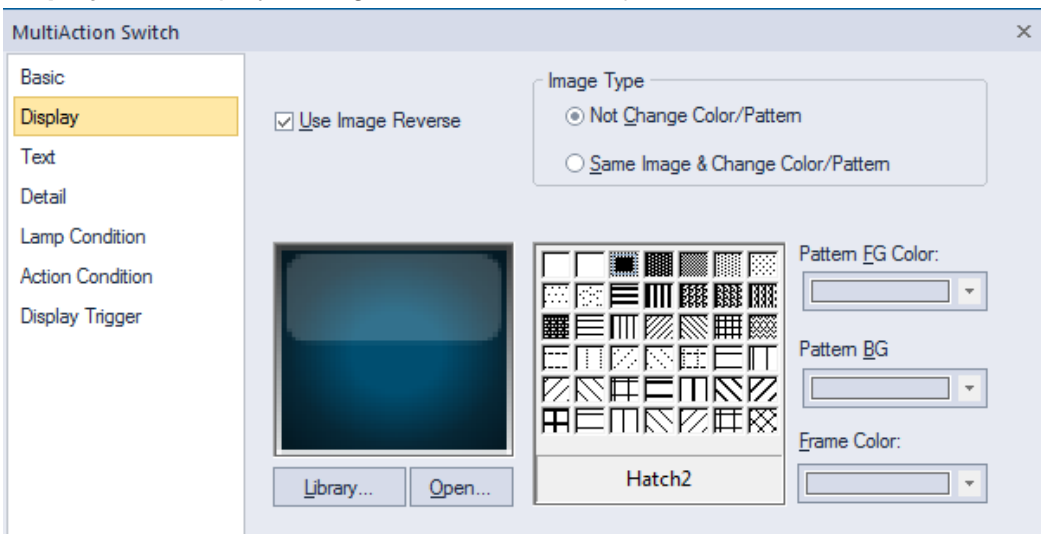

- **Transparent BG Image:** Check the checkbox to make the image background transparent. You cannot use a transparent background and the reverse image setting at the same time.
- **Use Image Reverse:** The switch image is reversed when you tap the object or a condition is met. If you set this option, you cannot use the **Transparent BG Image** option or the On/Off image. If you set the **Transparent BG Image** option, you cannot use this option.
- **On:** Click to configure options for the object in the “On” state.
- **Off:** Click to configure options for the object in the “Off” state.
- **Off->On Copy:** Copies all image properties in the Off state to On.
- **On->Off Copy:** Copies all image properties in On status to Off.
- **Image Type:** Set whether or not to change colors and patterns when switching between “On” and “Off” states. If you select the change color or pattern option, you must select a vector image for the object. To view characteristics of raster or vector images, refer to **<2.4.1 Managing Graphic Libraries>**.

Not Change Color/Pattern	Use the original image. You can apply the pattern or color to the image. Select the image to display for the “On” or “Off” states from raster, vector, or user registered images.
Same Image & Change Color/Pattern in On/Off	Select a vector image. You cannot select a raster image. Apply a pattern or color to the image.

- **Library:** Click to select an image from the library.
- **Open:** Click to browse images on your computer. When you select an image from your computer, it will be added to the image library automatically.
- **Pattern:** Click a pattern to apply to the image. This option is available only when you select the change color or pattern option in **Image Type**. Patterns are applied to specific parts of objects, but not to the frames. The frames are different for each image. Refer to the screenshots below.

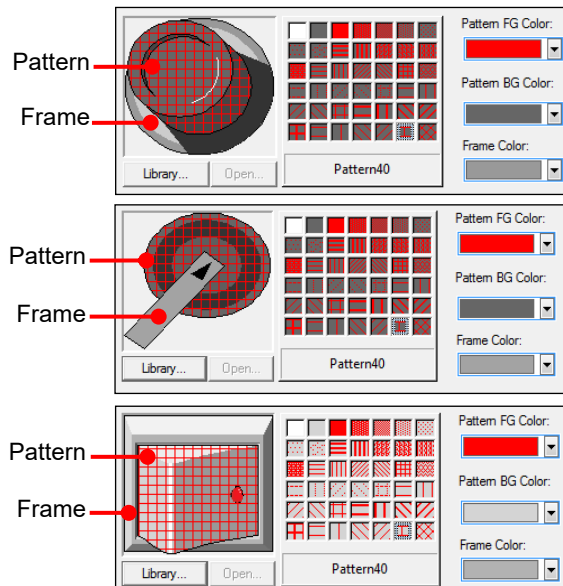

- **Pattern FG Color:** Set a color for the foreground pattern.
- **Pattern BG Color:** Set a color for the background pattern.
- **Frame Color:** Set a frame color.

- **Text:** The text settings for multi switch objects are shown in the screenshot below.

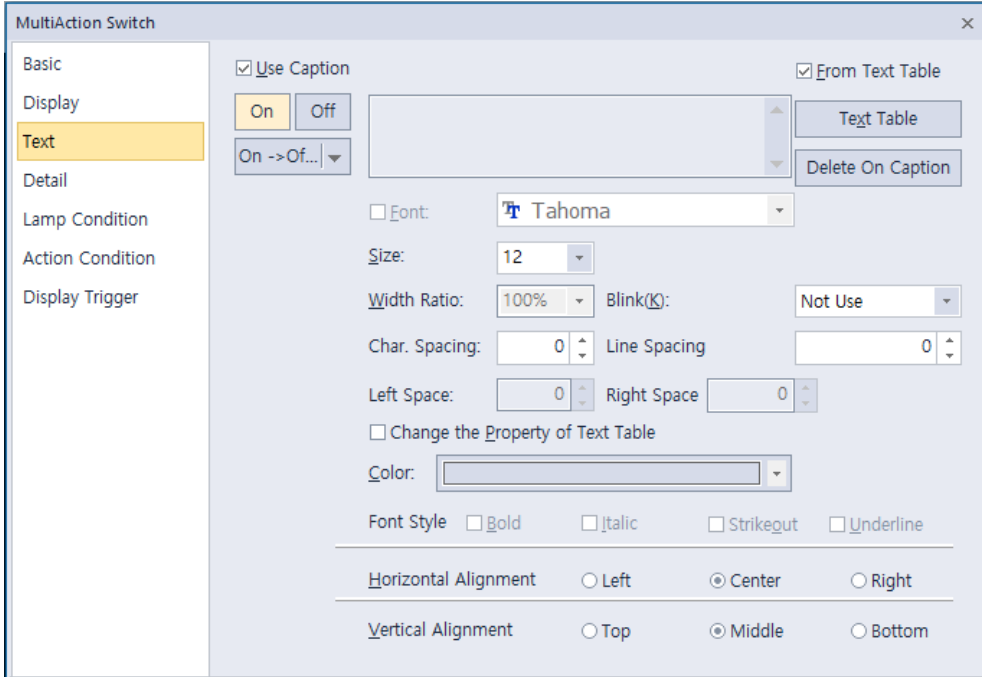

- **Use Caption:** Check the checkbox to use a text caption with the object. When you select this option, you can input text from a text table.
- **On:** Click to configure options for the object in the “On” state. You must input text from a text table.
- **Off:** Click to configure options for the object in the “Off” state. You must input text from a text table.
- **From Text Table:** Check the checkbox to add text from a text table. The Text Table option will be activated and the text input area will close. Add the required text to the text table before editing the object. You must select text for the “On” and “Off” states from the same text table.
- **Text Table:** Click to open the text table and select text. The color and font properties set in the text table will be imported with the text.

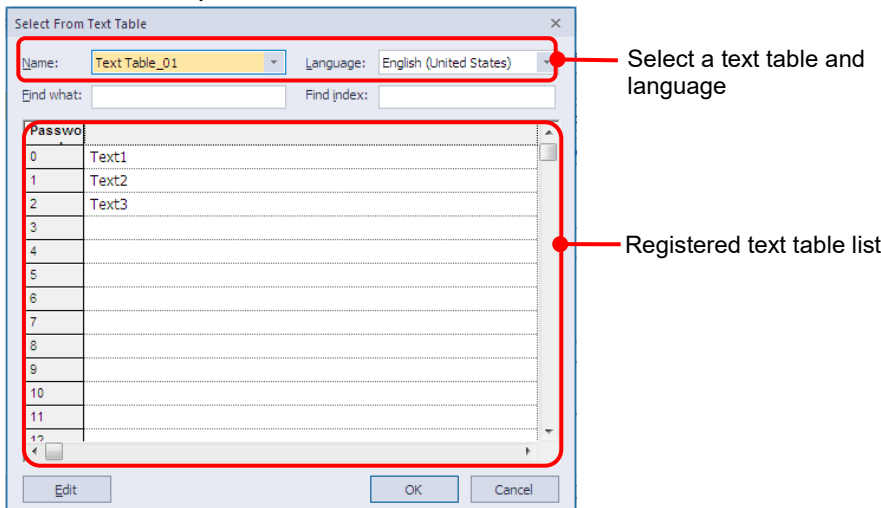

- **On <-> Off Copy:** Click to copy the text and formatting from the “On” state to the “Off” state or vice versa.
- **Copy Only Caption:** You can open the dropdown menu next to [Copy to other state] to select [Copy Only Caption]. This feature allows you to copy only the currently selected text string to another state.

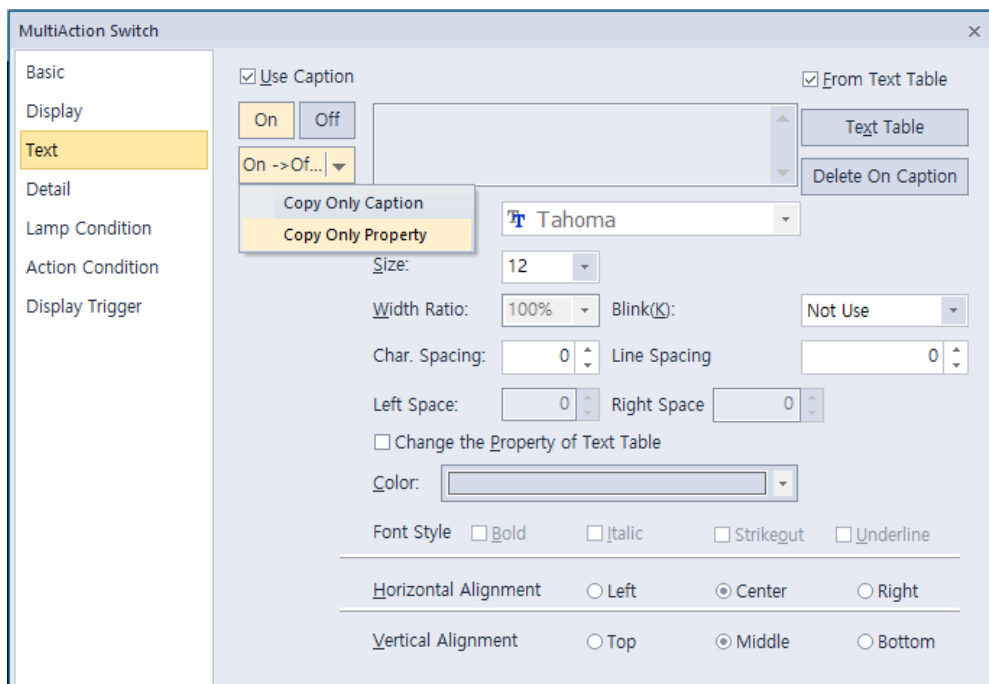

- **Copy Only Property:** You can open the dropdown menu next to [On -> Off] to select [Copy Only Property]. This feature allows you to copy all properties except the currently selected text string are copied to another state.
- **Delete On/Off Caption:** Click to clear text settings for the current state.
- **Font:** Select a font from the drop-down list.
- **Size:** Select a text size from the drop-down list or enter a value directly into the field.
- **Width Ratio:** Expand or condense the text by selecting a ratio from the drop-down list or entering a value directly into the field. You can set a ratio of 1%-600%.
- **Blink:** Set the blink speed for the caption.
XP30-BTE, XP30-TTE, XP40-TTE, and XP50-TTE are not supported.

Not use	The caption will not blink.
Slow	The caption will blink every three seconds.
Normal	The caption will blink every two seconds.
Fast	The caption will blink every second.

- **Space:** Set the space on the object. If you select Left align in Horizontal Alignment, you can set the left space, and if you select Right Align, you can set the right space.
- **Char. Spacing: Set text** intervals. If the value is a negative number, the spacing will decrease and if the value is a very small negative number, it can be overlaid or have the same effect as a positive number.
- **Line. Spacing: Set line** spacing. If the value is a negative number, the spacing will decrease, and if the value is a very small negative number, it can be overlaid of have the same effect as a positive number.
- **Change the Property of Text Table:** Click to apply different color and font properties to the text from those specified in the text table. This option is active only when you fetch text from the text table.
- **Color:** Select a font color.

- **Font Style:** Select a font style (bold, italic, strikethrough, or underline). You can apply more than one option at a time.
- **Horizontal Alignment:** Set the horizontal alignment (left, center, or right).
- **Vertical Alignment:** Set the vertical alignment (top, middle, or bottom).

• **Detail:** The detail settings for multi switch objects are shown in the screenshot below.

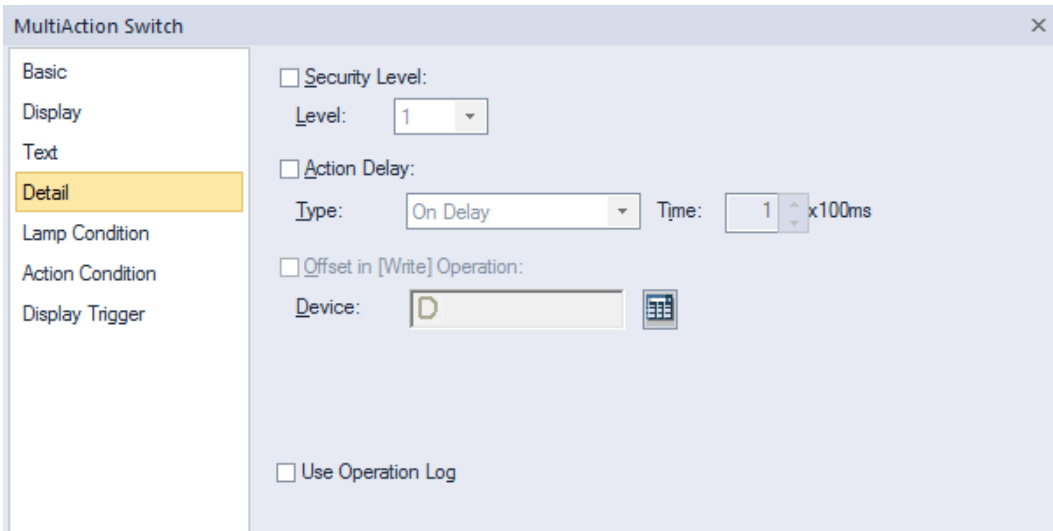

- **Security Level:** Set whether or not to require a password to use the object.
- **Level:** Set the security level for the object. The higher the security level, the shorter the authorization time when the password is entered. When the authorization time expires, the user must enter the password again to use the object.
- **Action Delay:** Set to delay the action triggered by the switch by a specified time.
- **Type:** Set the type of action delay.

On Delay	When the switch is activated, the action is performed after the delay time that you specify.
Press Twice	When the switch is activated once, a dialog box is invoked to allow the user to verify the operation. When the switch is activated a second time, the action is performed after the delay time that you specify.

- **Time:** Set the length of time for the action delay.
- **Offset in [Write] Operation:** Set to use the Offset function. The MultiAction Switch does not support this function.
- **Device:** Enter a device or tag address directly into the input field or click the keypad icon to the right to specify a device or tag address. When you click the keypad icon to open the Device window, you can also specify network settings, if necessary.
- **Use Operation Log:** Set to allow the device to be monitored in an operation log.

- **Lamp Condition:** The lamp condition settings for multi switch objects are shown in the screenshot below.

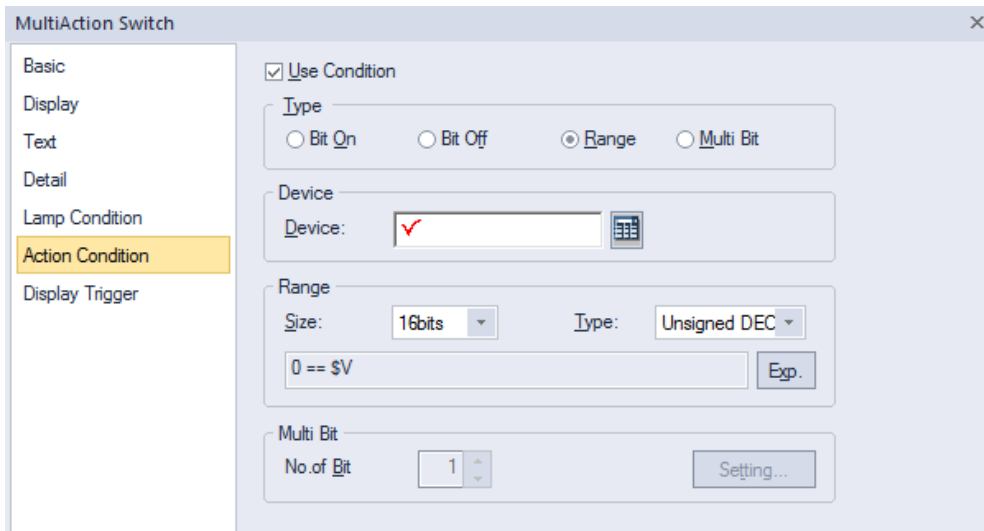

- **Use Condition:** If you want to control a lamp with a method other than simply turning it on when the switch is activated, you can select a different action.
- **Type:** Select a condition for lamp control.

Bit	When the device state is on, the lamp is on.
Word	When the condition is met, the lamp is on.

- **Bit:** If you selected the bit condition type, specify a bit device.

Device	Enter a device or tag address directly into the input field or click the keypad icon to the right to specify a device or tag address. When you click the keypad icon to open the Device window, you can also specify network settings, if necessary.
---------------	--

- **Word:** If you selected the word condition type, specify a word device.

Device	Enter a device or tag address directly into the input field or click the keypad icon to the right to specify a device or tag address. When you click the keypad icon to open the Device window, you can also specify network settings, if necessary.
Size	16 bit or 32 bit.
Type	Signed decimal, unsigned decimal, or BCD, or float.
Exp.	Click to designate the expression as conditional.

- **Use Lamp Offset:** Click to set an offset for the lamp.

- **Action Condition:** The action condition settings for multi switch objects are shown in the screenshot below.

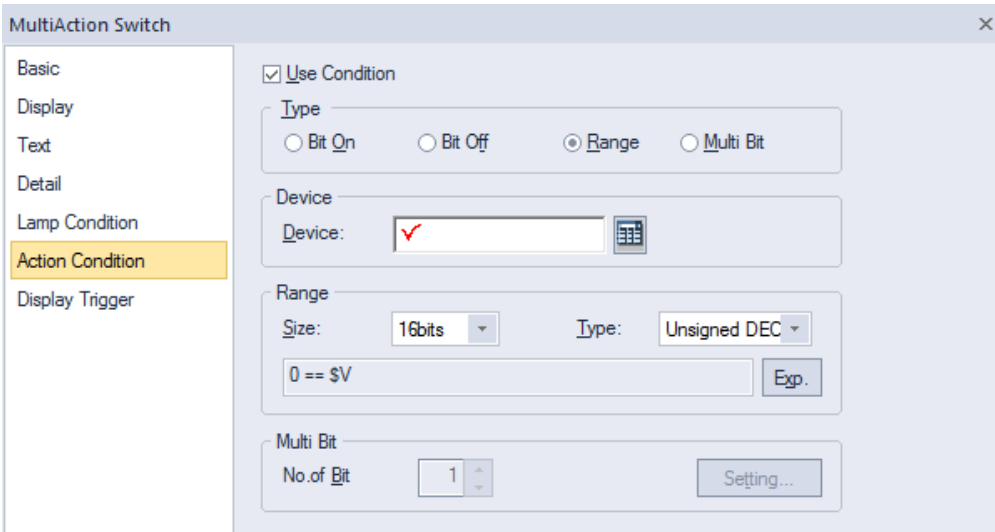

- **Use Condition:** Set whether or not to specify a condition for the action.
- **Type:** Set a type of condition to specify.

Bit On	The action is performed when the device is switched on.
Bit Off	The action is performed when the device is switched off.
Range	The action is performed when the value falls within the specified range.
Multi Bit	The action is performed when the logical operation result of multiple devices is met.

- **Device:** Enter a device or tag address directly into the input field or click the keypad icon to the right to specify a device or tag address. When you click the keypad icon to open the Device window, you can also specify network settings, if necessary.
- **Range:** If you select the range condition, specify the range.

Size	16 bit or 32 bit.
Type	Signed decimal, unsigned decimal, BCD, or float.
Exp.	Click to designate the expression as conditional.

- **Multi Bit:** If you select the multi bit condition, specify the number of bits and click [Setting] to specify the bit conditions.

- **Display Trigger:** The display trigger settings for multi switch objects include the following.

- **Use Condition:** Set whether or not to specify a condition for the display trigger.
- **Type:** Set a type of condition to specify.

Bit On	The object will display when the device is on.
Bit Off	The object will display when the device is off
Range	The object will display when the range condition of the device is satisfied.
Multi Bit	The object will display when the logical operation results of multiple device are satisfied.

- **Device:** Enter a device or tag address directly into the input field or click the keypad icon to the right to specify a device or tag address. When you click the keypad icon to open the Device window, you can also specify network settings, if necessary.
- **Range:** If you select the range condition, specify the range.

Size	16 bit or 32 bit.
Type	Signed decimal, unsigned decimal, BCD, or float
Exp.	Click to designate the expression as conditional.

- **Multi Bit:** If you select the multi bit condition, specify the number of bits and click [Setting] to specify the bit conditions.

4.3.3 Message Objects

You can use message objects to display messages based on specified conditions of bit or word devices. You must add the messages to a text table to invoke them with a message object.

Note

- If the message object is not connected with PLC device, only background image is displayed.
 - ✧ For details, refer to **<Appendix 5. Object Display Rule before Communication Connection>**.

4.3.3.1 Bit Message

This section describes available settings for bit message objects.

- **Basic:** The basic settings for bit message objects are shown in the screenshot below.

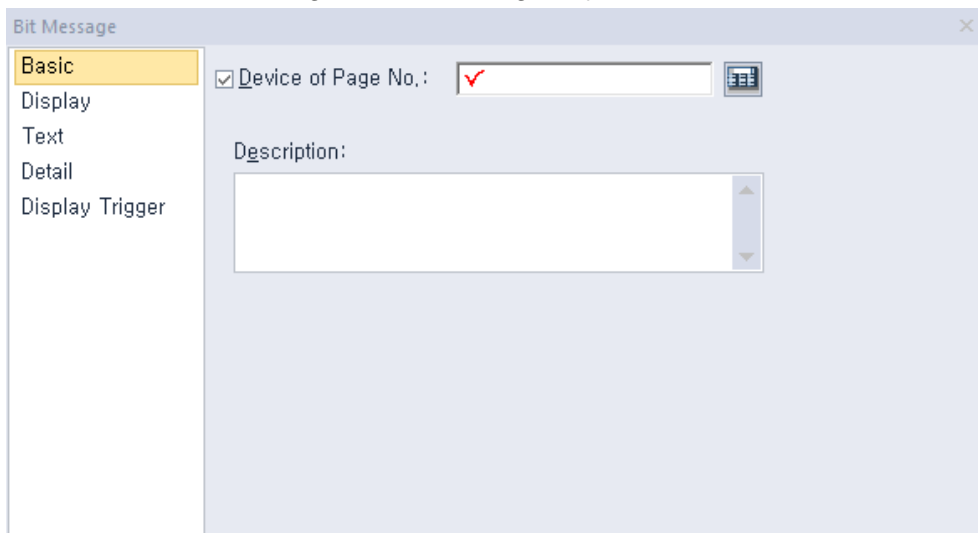

- **Device:** Enter a device or tag address directly into the input field or click the keypad icon to the right to specify a device or tag address. When you click the keypad icon to open the Device window you can also specify network settings, if necessary.
- **Description:** Enter a description for the object.

- **Display:** The display settings for bit message objects are shown in the screenshot below.

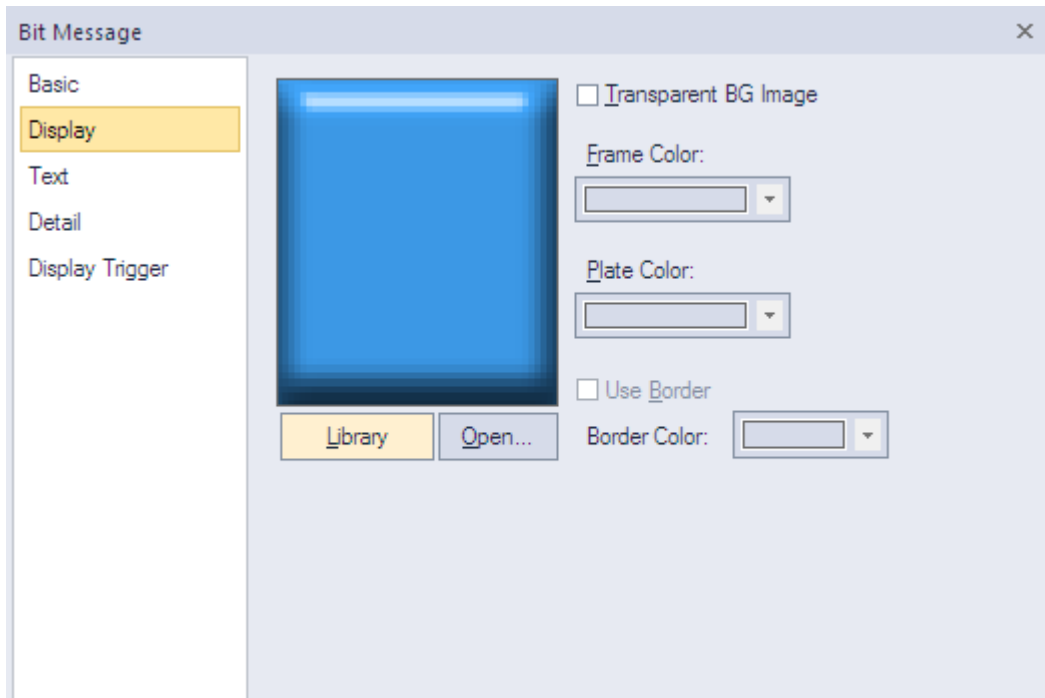

- **Library:** Click to select an image from the library.
- **Open:** Click to browse images on your computer. When you select an image from your computer, it will be added to the image library automatically.
- **Transparent BG Image:** Check the checkbox to make the image background transparent. You cannot use a transparent background and the reverse image setting at the same time.
- **Frame Color:** Select a frame color.
- **Plate Color:** Select a plate color.
- **Use Border:** Set whether or not to apply a border to the message area.
- **Border Color:** Select a border color.

- **Text:** The text settings for bit message objects are shown in the screenshot below.

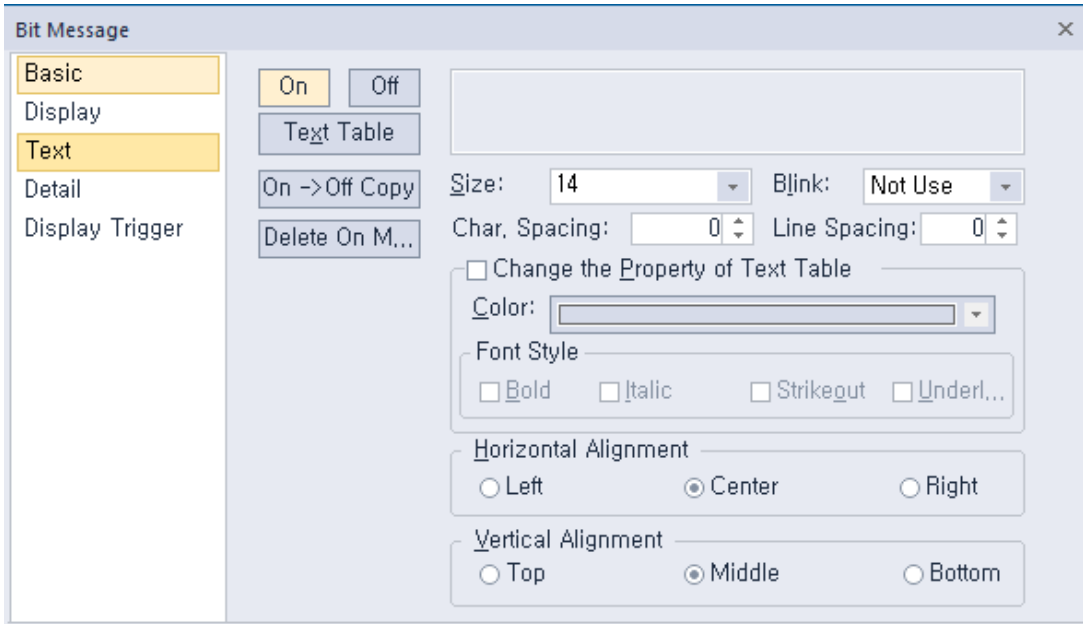

- **On:** Click to configure options for the object in the “On” state. You can input text only from a text table.
- **Off:** Click to configure options for the object in the “Off” state. You can input text only from a text table.
- **Text Table:** Click to open the text table and select text. The color and font properties set in the text table will be imported with the text.
- **On <-> Off Copy:** Click to copy the text and formatting from the “On” state to the “Off” state or vice versa.
- **Delete On/Off Msg.:** Click to delete the text for the selected state.
- **Size:** Select a text size from the drop-down list or enter a value directly into the field.
- **Blink:** Set a blink speed for the object:
XP30-BTE, XP30-TTE, XP40-TTE, and XP50-TTE are not supported.

Not use	The object will not blink.
Slow	The object will blink every three seconds.
Normal	The object will blink every two seconds.
Fast	The object will blink every second.

- **Char. Spacing:** Set text intervals. If the value is a negative number, the spacing will decrease and if the value is a very small negative number, it can be overlaid or have the same effect as a positive number.
- **Line Spacing:** Set line spacing. If the value is a negative number, the spacing will decrease, and if the value is a very small negative number, it can be overlaid of have the same effect as a positive number.
- **Change the Property of Text Table:** Click to apply different color and font properties to the text from those specified in the text table. This option is active only when you fetch text from the text table.

Color	Select a font color.
--------------	----------------------

Font Style

Select a font style (bold, italic, strikethrough, or underline). You can apply more than one option at a time.

- **Horizontal Alignment:** Set the horizontal alignment (left, center, or right).
- **Vertical Alignment:** Set the vertical alignment (top, middle, or bottom).

- **Detail:** The detail settings for bit message objects are shown in the screenshot below.

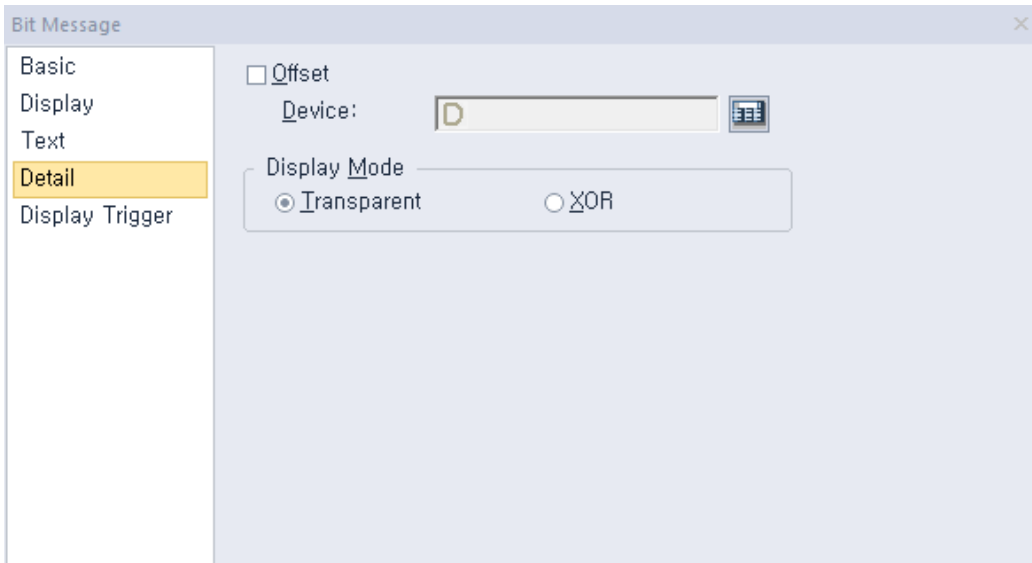

- **Offset:** Check the checkbox to use the Offset function. You can offset the device address based on the value of the offset device. For example, if the starting device address is P100, XP-Builder reads the value from the offset device and offsets the address by that value. If the offset value is 10, for example, then the referenced device address is P110.
- **Device:** Enter a device or tag address directly into the input field or click the keypad icon to the right to specify a device or tag address. When you click the keypad icon to open the Device window you can also specify network settings, if necessary.
- **Display Mode:** Set an option for the color of the message based on the background color.

Transparent	Display the message transparently, in contrast to the background image.
XOR	Display the message in a color that is easily distinguishable from the background image.

- **Display Trigger:** The display trigger settings for bit message objects are shown in the screenshot below.

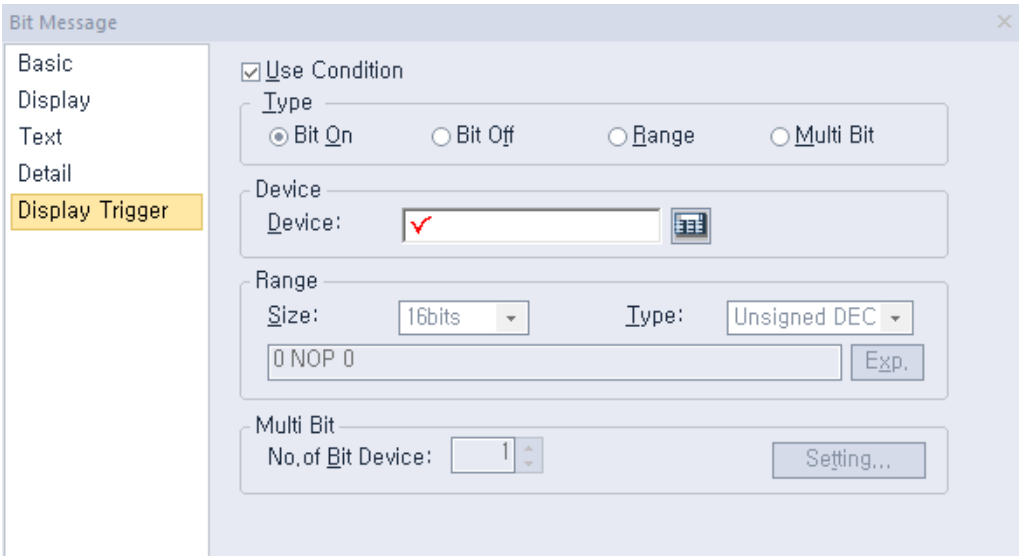

- **Use Condition:** Set whether or not to specify a condition for the action.
- **Type:** Set a type of condition to specify.

Bit On	The action is performed when the device is switched on.
Bit Off	The action is performed when the device is switched off.
Range	The action is performed when the value falls within the specified range.
Multi Bit	The action is performed when the logical operation result of multiple devices is met.

- **Device:** Enter a device or tag address directly into the input field or click the keypad icon to the right to specify a device or tag address. When you click the keypad icon to open the Device window, you can also specify network settings, if necessary.
- **Range:** If you select the range condition, specify the range.

Size	16 bit or 32 bit.
Type	Signed decimal, unsigned decimal, BCD, or float.
Exp.	Click to designate the expression as conditional.

- **Multi Bit:** If you select the multi bit condition, specify the number of bits and click [Setting] to specify the bit conditions.

4.3.3.2 Word Message

This section describes available settings for word message objects.

- **Basic:** The basic settings for word message objects are shown in the screenshot below.

The screenshot shows the 'Word Message' configuration window. The 'Basic' tab is active. The 'Message Device' field has a red checkmark and a keypad icon. The 'Size' is set to '16bits' and 'Type' is 'Unsigned DEC'. Under 'Message Num', 'Indirect' is selected. Under 'TextTable Num', 'Device' is selected with a keypad icon. The 'Number of' field is set to '1'. The 'Description' field is empty.

- **Message Device:** Enter a device or tag address directly into the input field or click the keypad icon to the right to specify a device or tag address. When you click the keypad icon to open the Device window you can also specify network settings, if necessary.
- **Size:** Select a data size (16 bit or 32 bit). Changing the data size for an existing object will delete the conditions specified in the case settings.
- **Type:** Select a data type (Signed decimal number, unsigned decimal number, or BCD).
- **Message Num:** Set the message type. Changing the message type for an existing object will delete the conditions specified in the case settings. Message number is the number for each row on the edit window of the text table.

Languages			
번호	영어(미국)	러시아어(러시아)	포르투갈어(포르투갈)
0	English	Russian	Portugal
1			
2	English	английский	Inglês
3	Russian	русский	Russo
4	Portugal	португальский	Portugues
5	Spanish	испанский	Espanhol
6	French		
7	German		
8	Italian		
9	Romanian		
10	Czech		
11	Polish		
12	Bulgarian	Болгарский	Búlgaro
13			
14			
15			
16			
17	Home	Основной	Casa
18	Alarms	Сигналы тревоги	Alarmes
19	Info	Информация	Info
20	Settings	Настройки	Configurações
21			
22	Open	Открыть	Carregar
23	Occurred	Наступили	Ocorreu
24	Message	Значение	Mensagem
25	Restoration	Восстановлены	Restauracion
26	Frequence	Повторение	Frequência
27	Unrestoration	Не восстановлены	Unrestoration

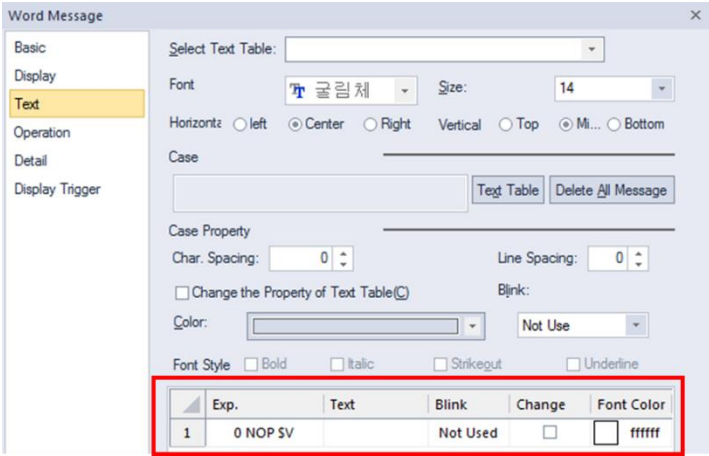
Indirect	A value is read from the referenced device to invoke the message from the table.
Case	<p>If the reference device meets the conditions specified in the case settings, the message is invoked. Set the conditional statement from the text tab.</p> 
Fixed	<p>Displays the message of selected number. If set to a 'Fixed', the [Offset] device cannot be used.</p>

Text table number: Sets the method for selecting the text table number. The text table number is the number in front of a text table, as shown below.

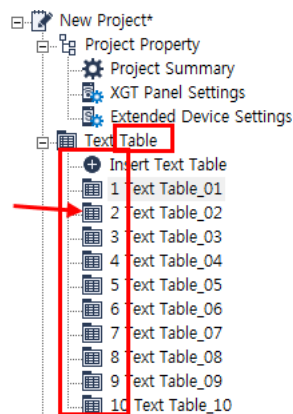

Fixed	Set the text table number to be displayed manually.
Device	Displays the text table number of the value of the set device. For example, if the value of the device is 7, use [7 Text Table_7].

Number of continuous display rows: Displays the messages of the number of continuous rows from the first message number. For example, it is shown as follows if the text table is like below, the value of the message device HW0000 is 3, and the number of continuous display of rows is 6.

No	English (United States)	Color	Italic	Underline	StrikeOut	Bold
0	자동운전시작		Off	Off	Off	Off
1	운전정지		Off	Off	Off	Off
2	PLC ALIVE(1초 주기)		Off	Off	Off	Off
3	A-UMAC ERROR ACK		Off	Off	Off	Off
4	A-PC처리중 ERROR ACK		Off	Off	Off	Off
5	A-VISION ERROR ACK		Off	Off	Off	Off
6	B-UMACERROR ACK		Off	Off	Off	Off
7	B-PC처리중 ERROR ACK		Off	Off	Off	Off
8	B-VISION ERROR ACK		Off	Off	Off	Off

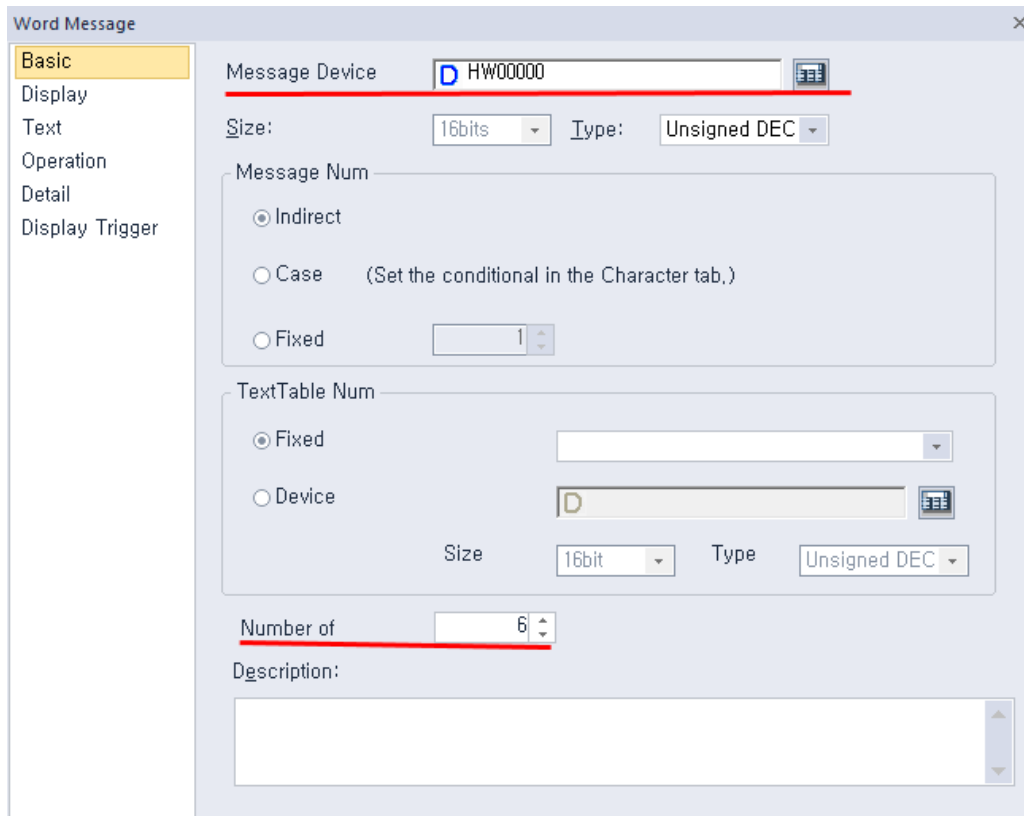

Set as above, display as below.

If displays continuous rows, the property of text table is based on first rows set value.

If the message type is set to **Case**, conditional expressions can be set in the case settings. If the message type is set to **Indirect**, conditional expressions cannot be set in the case settings.

If the size or type of data changes, all the conditional expressions that are set in the case settings when the data was created will be deleted.

If you change the message type from **Case** to **Indirect**, all the conditional expressions in the case settings will be deleted.

- **Description:** Enter a description for the object.

- **Display:** The display settings for word message objects are shown in the screenshot below.

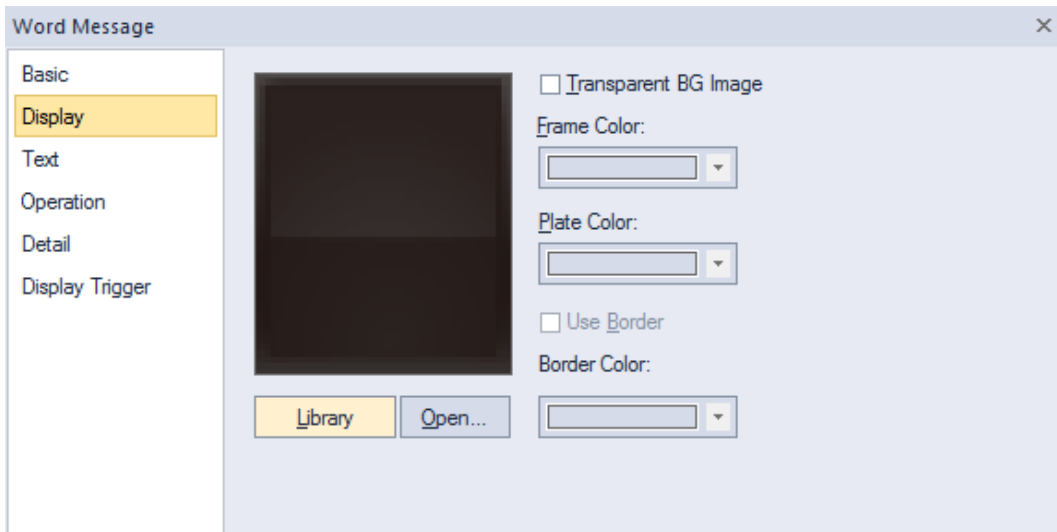

- **Library:** Click to select an image from the library.
- **Open:** Click to browse images on your computer. When you select an image from your computer, it will be added to the image library automatically.
- **Transparent BG Image:** Check the checkbox to make the image background transparent. You cannot use a transparent background and the reverse image setting at the same time.
- **Frame Color:** Select a frame color.
- **Plate Color:** Select a plate color.
- **Use Border:** Set whether or not to apply a border to the message area.
- **Border Color:** Select a border color.

- **Text:** The text settings for word message objects are shown in the screenshot below.

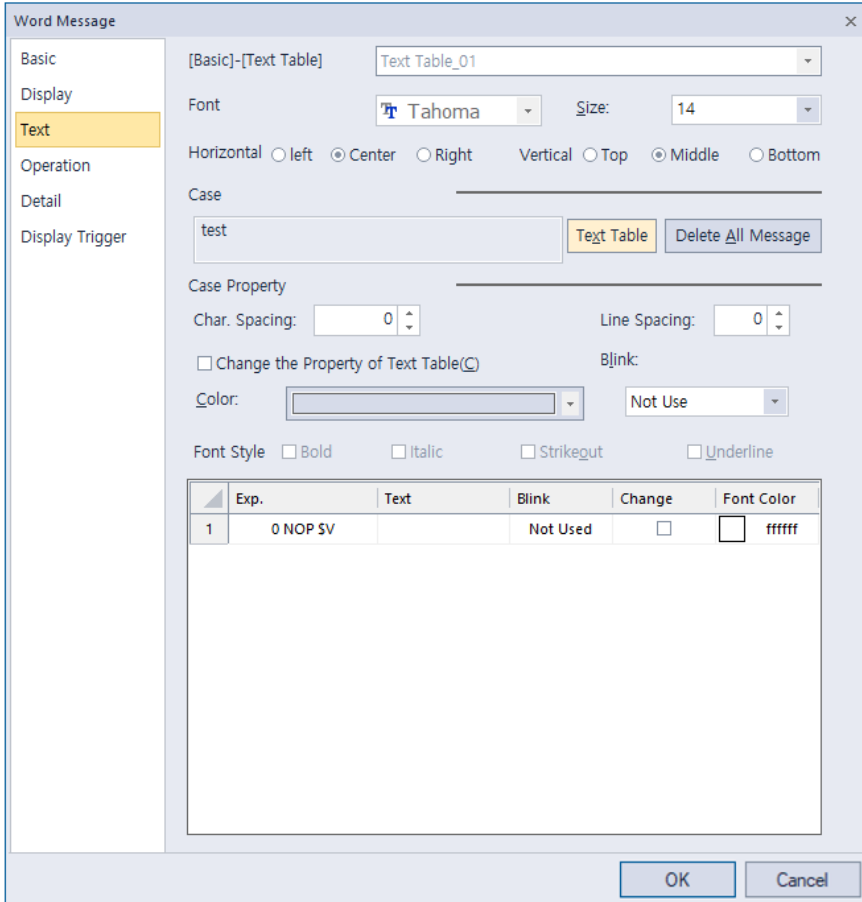

- **[Basic]-[Text Table]:** Displays the text table set in the Basic tab.
- **Font:** The font settings for a message cannot be set by the user. A message displayed in a word message object shares the default settings of a pre-created text table. Therefore, the font for the message corresponds with the font of the current editing language that is set in [COMMON] ► [Project Property Setting] ► [Language].
- **Size:** Select a text size from the drop-down list or enter a value directly into the field.
- **Horizontal Alignment:** Set the horizontal alignment (left, center, or right).
- **Vertical Alignment:** Set the vertical alignment (top, middle, or bottom).
- **Case:** Show the text set as default for the object when message num is set as Case. You can change it by selecting it from the text table.
- **Text Table:** Click to open the text table and select text. The color and font properties set in the text table will be selected with the text.
- **Delete All Message:** Delete any existing messages assigned to the object.
- **Case Property:** Set the properties of the text to be displayed in the default state.
- **Char. Spacing:** Set text intervals. If the value is a negative number, the spacing will decrease and if the value is a very small negative number, it can be overlaid or have the same effect as a positive number.
- **Line Spacing:** Set line spacing. If the value is a negative number, the spacing will decrease, and if the value is a very small negative number, it can be overlaid or have the same effect as a positive number.

Change the Property of Text Table: Click to apply different color and font properties to the text from those specified in the text table. This option is active only when you fetch text from the text table. This option is available only when the message type is set to **Case** in the basic settings. The text to be set here is displayed in the message object by default when all the conditions that are set in the case settings are not met. In the Indirect type where the text string number for a device is designated, the message will not be displayed in the message object when the text string number for the device does not exist. That is, text cannot be selected from a text table when the message type is **Indirect** and text can be selected from a text table when the message type is **Case**.

- **Color:** Select a font color.
- **Blink:** Select a blink speed for the object:
XP30-BTE, XP30-TTE, XP40-TTE, and XP50-TTE are not supported.

Not use	The object will not blink.
Slow	The object will blink every three seconds.
Normal	The object will blink every two seconds.
Fast	The object will blink every second.

- **Font Style:** Select a font style (bold, italic, strikeout, or underline). You can apply more than one option at a time.
- **Range:** Insert conditions when [Case] is selected in [Basic]-[Message Num].
Click the button to the right of the cell in the [Range] column to display a dialog box for inserting conditions.

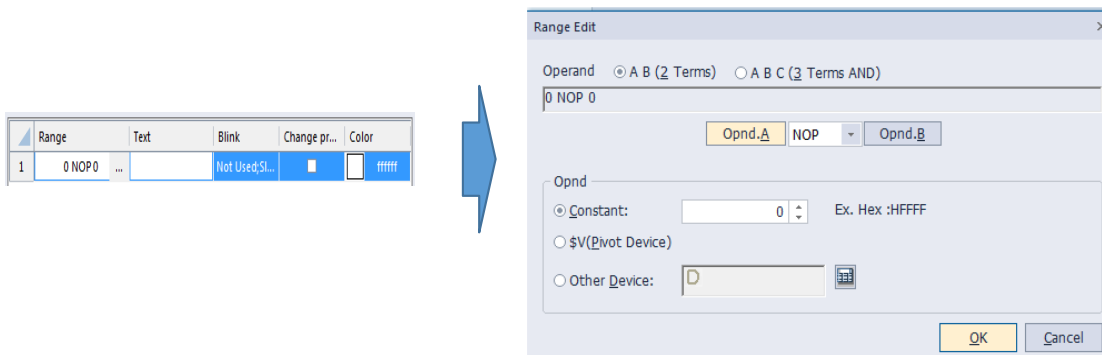

When character strings are selected, click the button to the right of the cell in the [Text] column to display a dialog box for inserting a text table. [Color] is displayed as set in [Text Table]. You can change [Color] by checking the [Change Property] checkbox.

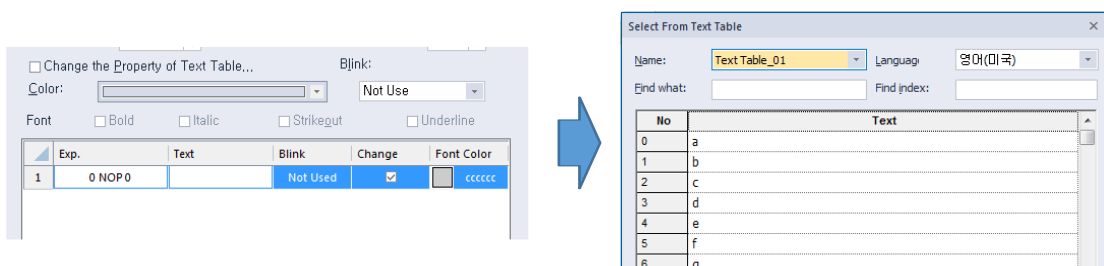

To copy and paste an item, select the row containing the item and press Ctrl+C, then press Ctrl+V to paste it into the desired row.

To remove an item, click the row or column to remove and press the Delete key. For vector images, the frame color column and the background color column are added.

Exp.	Text	Blink	Change	Font C...	Frame ...	BG Color
1	0 NOP 0	Slow	<input type="checkbox"/>	<input type="checkbox"/> fffff	<input type="checkbox"/> 000...	<input type="checkbox"/> fffff

To change the order of [Range], click and drag the row to where you want to relocate, and release the mouse button.

Range	Text	Blink	Change pr...	Color
1	1 == \$V	Not Used;Sl...	<input type="checkbox"/>	<input type="checkbox"/> ccccc
2	10 == \$V	Not Used;Sl...	<input type="checkbox"/>	<input type="checkbox"/> ccccc
3	20 == \$V	Not Used;Sl...	<input type="checkbox"/>	<input type="checkbox"/> ccccc
4	0 NOP 0	Not Used;Sl...	<input type="checkbox"/>	<input type="checkbox"/> fffff

For example, to move the third row to the second row, click and drag the third row to the second row and release the mouse button when the pointer is positioned between the rows as shown below.

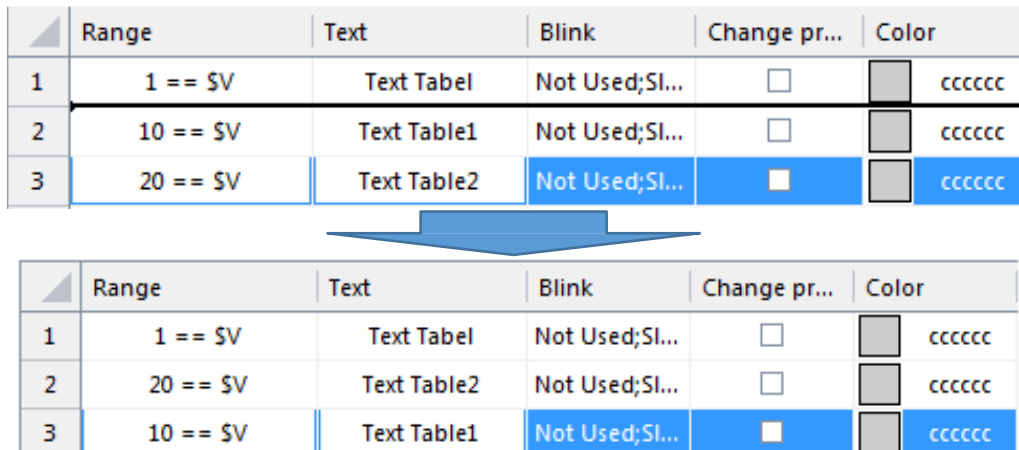

- **Operation:** The operation settings for word message objects are shown in the screenshot below.

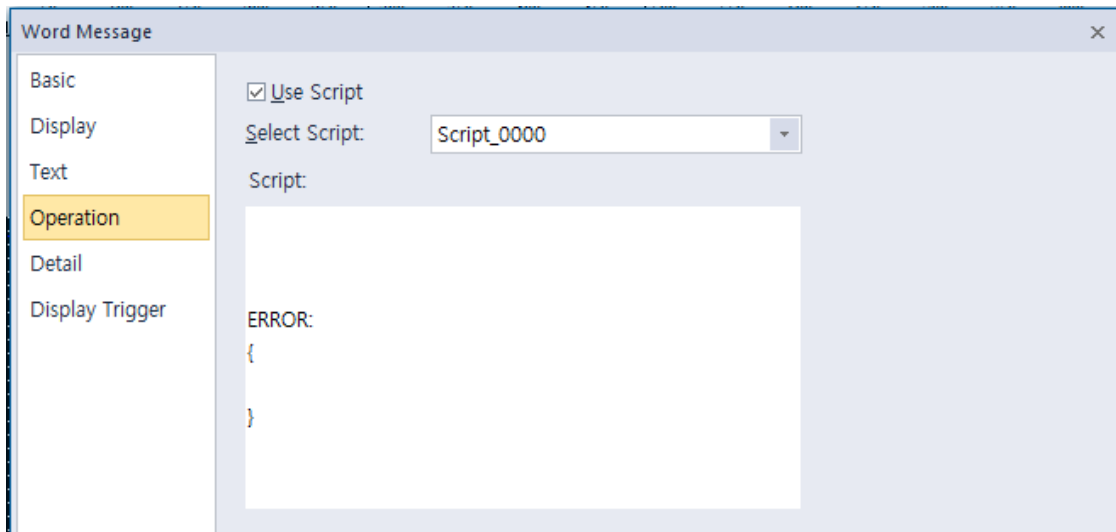

- **Use Script:** Check the checkbox to use a script with the object.
 - **Select Script:** Select a script from the drop-down list.
 - **Script:** When you select a script, it appears here. To modify a script, refer to [<4.2 Scripts>](#).
- **Detail:** The detail settings for word message objects are shown in the screenshot below.

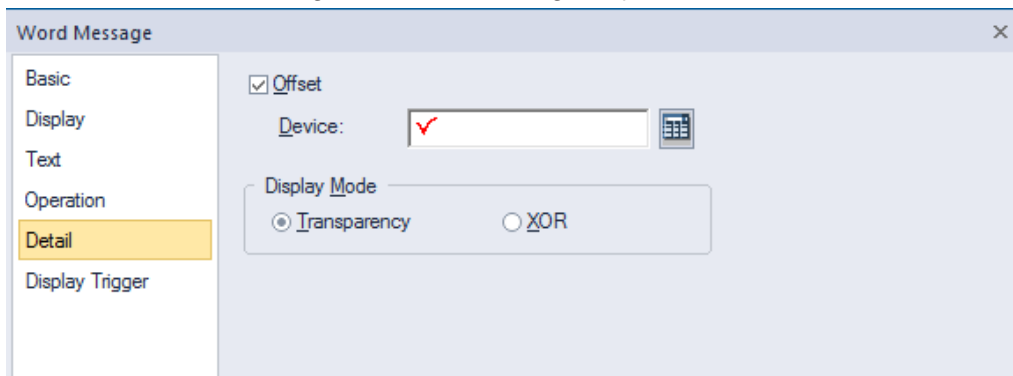

- **Offset:** Check the checkbox to use the Offset function. You can offset the device address based on the value of the offset device. For example, if the starting device address is P100, XP-Builder reads the value from the offset device and offsets the address by that value. If the offset value is 10, for example, then the referenced device address is P110. Offset cannot be set when [Basic]-[Message Number] selection method is [Fixed].
- **Device:** Enter a device or tag address directly into the input field or click the keypad icon to the right to specify a device or tag address. When you click the keypad icon to open the Device window you can also specify network settings, if necessary.
- **Display Mode:** Select an option for the color of the message based on the background color.

Transparent	Set the message to be transparent and contrast with the background image.
XOR	Display the message in a color that is easily distinguishable from the background image.

- **Display Trigger:** The display trigger settings for word message objects are shown in the screenshot below.

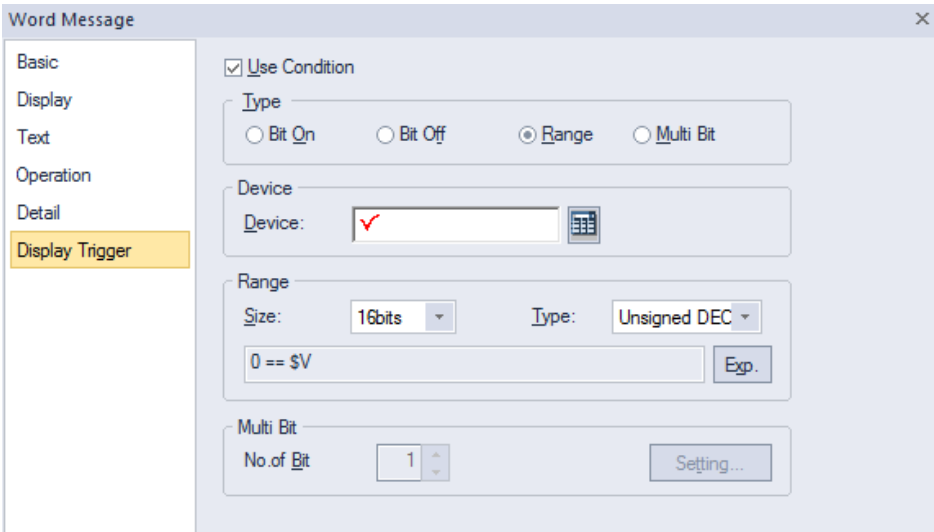

- **Use Condition:** Set whether or not to specify a condition for the action.
- **Type:** Set a type of condition to specify.

Bit On	The action is performed when the device is switched on.
Bit Off	The action is performed when the device is switched off.
Range	The action is performed when the value falls within the specified range.
Multi Bit	The action is performed when the logical operation result of multiple devices is met.

- **Device:** Enter a device or tag address directly into the input field or click the keypad icon to the right to specify a device or tag address. When you click the keypad icon to open the Device window, you can also specify network settings, if necessary.
- **Range:** If you select the range condition, specify the range.

Size	16 bit or 32 bit.
Type	Signed decimal, unsigned decimal, BCD, or float.
Exp.	Click to designate the expression as conditional.

- **Multi Bit:** If you select the multi bit condition, specify the number of bits and click [Setting] to specify the bit conditions.

4.3.4 Numeric/Text Objects

Numeric and text objects show values from devices or input values from keypads to devices. Four types of numeric/text objects are available and are described in the below table.

Type	Description
Numeric Input	Enters and displays the value in the word device connected to the PLC on the XGT Panel.
Numeric Display	Displays the word device data connected to the PLC in numbers on the XGT Panel.
Text Input	Writes the entered text in the word device in ASCII code.
Text Display	Displays the text recognizing the data saved in the word device as the ASCII code value.

Note

- If the numeric/text objects are not connected with PLC device, only background image is displayed.
 - ✘ For details, refer to **<Appendix 5. Object Display Rule before Communication Connection>**.

4.3.4.1 Numeric Input

You can use numeric input devices to enter values in word devices. This section describes available settings for numeric input objects.

- **Basic:** The basic settings for numeric input objects are shown in the screenshot below.

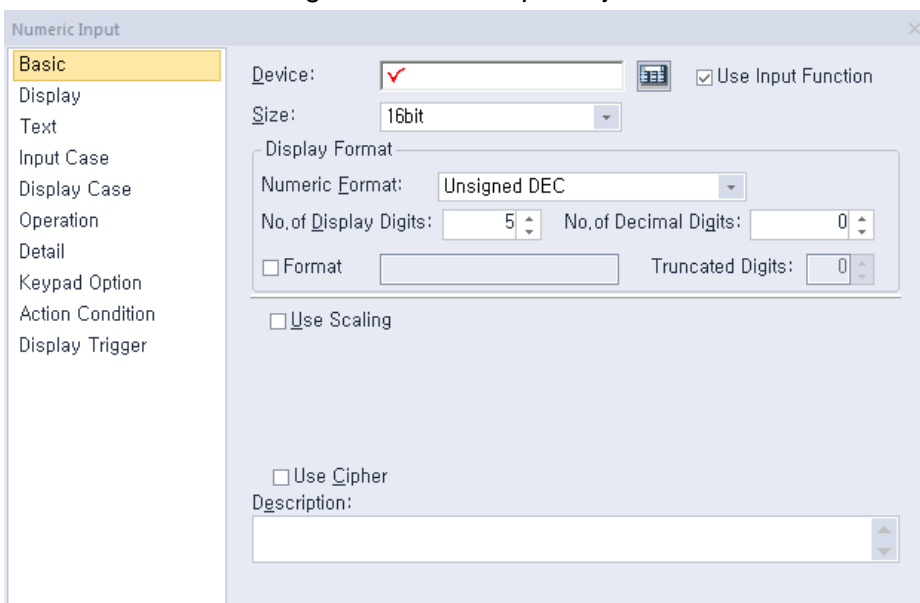

- **Device:** Enter a device or tag address directly into the input field or click the keypad icon to the right to specify a device or tag address. When you click the keypad icon to open the Device window you can also specify network settings, if necessary.
- **Use Input Function:** Uncheck this option to change the numeric input object to a numeric display object. Object property setting options automatically change to fit the object type. Refer to **<4.3.4.2 Numeric Display>** for detailed information.
- **Size:** Set a data size (16 bit upper byte, 16 bit lower type, 16 bit, or 32 bit). If you change the data size of an existing object, the input and display conditions will automatically change to match the new data size.
XP30-BTE, XP-30TTE, XP40-TTE, and the XP50-TTE do not support 16bit upper/lower byte.
- **Display Format:** Set the display format.

Numeric Format	<p>Set the number format.</p> <table border="1" style="width: 100%; border-collapse: collapse;"> <thead> <tr> <th style="width: 50%;">Format</th> <th style="width: 50%;">Example</th> </tr> </thead> <tbody> <tr> <td>Signed decimal</td> <td>-2184</td> </tr> <tr> <td>Unsigned decimal</td> <td>2184</td> </tr> <tr> <td>Octal</td> <td>4210</td> </tr> <tr> <td>Hexadecimal</td> <td>888</td> </tr> <tr> <td>Binary</td> <td>10010001000</td> </tr> <tr> <td>BCD</td> <td>888</td> </tr> <tr> <td>Float</td> <td>2184.0</td> </tr> </tbody> </table> <p>The Float format can be selected only when the data size is 32 bit.</p>	Format	Example	Signed decimal	-2184	Unsigned decimal	2184	Octal	4210	Hexadecimal	888	Binary	10010001000	BCD	888	Float	2184.0
Format	Example																
Signed decimal	-2184																
Unsigned decimal	2184																
Octal	4210																
Hexadecimal	888																
Binary	10010001000																
BCD	888																
Float	2184.0																
No. of Display Digits	<p>Set how many digits to display (up to 64). If the number of digits is less than the capacity of the device, empty spaces are filled with placeholders (" "). If the device value cannot be displayed in BCD format, it is expressed as "~".</p>																
No. of Decimal Digits	<p>Set how many places to put to the right of the decimal point when you select formats other than binary, octal, and hexadecimal.</p> <table border="1" style="width: 100%; border-collapse: collapse;"> <tr> <td style="background-color: #e0e0e0;">Fixed</td> <td>Enter the number of decimal digits directly.</td> </tr> <tr> <td style="background-color: #e0e0e0;">Device</td> <td>The number of decimal digits changes dynamically according to the device value.</td> </tr> </table>	Fixed	Enter the number of decimal digits directly.	Device	The number of decimal digits changes dynamically according to the device value.												
Fixed	Enter the number of decimal digits directly.																
Device	The number of decimal digits changes dynamically according to the device value.																
Format	<p>Set the display format of numbers and texts. User can specify the text format yourself or choose from the text table. You can enter text directly, but numbers are marked with *. The number of * is the number of numbers and is determined by the number of truncated digits.</p> <div style="border: 1px solid #ccc; padding: 5px; background-color: #f0f0f0;"> <input checked="" type="checkbox"/> Format 0 Truncated Digits: <input style="width: 50px;" type="text" value="2"/> <input style="width: 100px;" type="text"/> <input type="checkbox"/> From Text Table <input type="button" value="TextTable"/> </div> <table border="1" style="width: 100%; border-collapse: collapse;"> <tr> <td style="background-color: #e0e0e0;">Directly</td> <td>The text format is manually entered by the</td> </tr> </table>	Directly	The text format is manually entered by the														
Directly	The text format is manually entered by the																

	user.
From Text Table	Select the text format from the text table. In this case, you can change the text format according to the language switch.

Example)

Display Format

Numeric Unsigned DEC

No. of Display 5 No. of Decimal Digits: Device Const

Format 0

Truncated Digits: 1

cm From Text Table TextTable

In the case of setting as above, the result displayed on the XGT Panel differs depending on the device.

- If device value is 12345

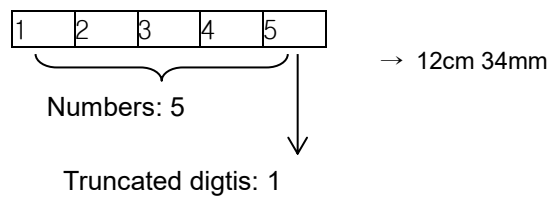

- If device value is 1234

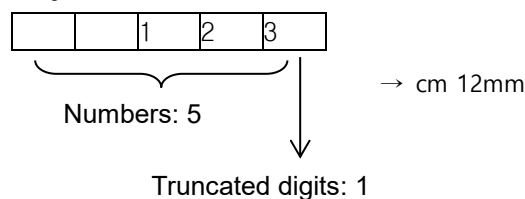



Note
 When the text format is specified in the text table, the text format (bold, strikethrough, etc.), color and font of the [Text Table] are not applied. In this case, each property set in the [Text] tab is applied.

Truncated Digits	Set a number of digits to truncate from the numerical value. Truncation occurs in order from the most significant bit (MSB) to the least significant bit (LSB).
-------------------------	---

- **Use Scaling:** When a user scales and inputs random values into an established PLC device address, this function can be applied. Actual PLC values and displayable values differ by data size and display type. If the value input by a user exceeds the maximum value, the maximum value is input into the device instead. If the value input by a user is lower than the minimum value, the minimum value is input into the device instead. If the input value is out of the input max/min value range of scaling, it is not entered.

Min Device Value	Input the minimum data value of PLC device to scale. Device: Able to set the minimum value as the device address. Constant: Able to set the minimum value as constant according to data size and numeric type.
-------------------------	--

Max Device Value	Input the maximum data value of PLC device to scale. Device: Able to set the maximum value as the device address. Constant: Able to set the maximum value as constant according to data size and numeric type.
-------------------------	--

Min. Input Value	Input the minimum data value to be displayed at scale. Device: Able to set the minimum value as the device address. Constant: Able to set the minimum value as constant according to data size and numeric type.
-------------------------	--

Max. Input Value	Input the maximum data value to be displayed at scale. Device: Able to set the maximum value as the device address. Constant: Able to set the maximum value as constant according to data size and numeric type.
-------------------------	--

Use Round Off	This option activates or deactivates rounding up to the scaled value.
----------------------	---

[Device value] → [Indicated value]

-10	-2
50	10 (decimal point to be always discarded)
53	10
86	17 (decimal point to be always discarded)
100	20
204	40 (decimal point to be always discarded)

If “Rounding up” is set, the values are rounded up as shown in the table below.

[Device value] → [Indicated value]

-10	-2
50	10 (decimal point to be rounded up)
53	11
86	17 (decimal point to be rounded up)
100	20
204	41 (decimal point to be rounded up)

In the below example, the maximum input value and the maximum device value are set to 1,000 and 100 respectively, while the actual input value is 2,000.

Use Scaling
 Use Round Off
 Device Range
 Device Min Dev. 0
 Constant: Max Dev. 100
 Input Range
 Device Min Out 0
 Constant: Max Out 1000

However, in the case of a number input device, after entering a value, when displaying it on an object, it outputs in the same way as a number output device. Therefore, the value may be displayed differently from the entered value. After entering the values as above, the object is displayed in the following way.

$$\{ (\text{Max Out} - \text{Min out}) / (\text{Max Dev.} - \text{Min Dev.}) \} * \text{Device}$$

$$\{ (1000 - 0) / (100 - 0) \} * 10 = 100$$

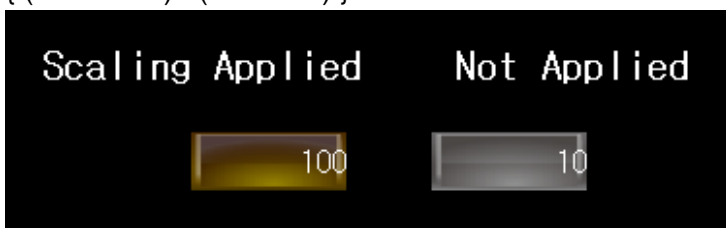

Any value above the maximum input value is recognized as the maximum value (1,000), so the device value becomes 100. Likewise, if you enter an input value under 0, the value is still recognized as 0 and the device value becomes 0.

Note

- The available device value range and displayable data value range differ by the size and type of the device, as shown in the below table.

Device Size	Device Type	Minimum	Maximum
16 bit upper type	Signed decimal	-128	127
	Unsigned decimal, binary, octal, hexadecimal	0	255
16 bit lower type	Signed decimal	-128	127
	Unsigned decimal, binary, octal, hexadecimal	0	255
16 bit	Signed decimal	-32768	32767
	Unsigned decimal	0	65535
	BCD	0	9999
32 bit	Signed decimal	-2147483648	2147483647
	Unsigned decimal	0	4294967295
	BCD	0	99999999

- When you input a number, the errors shown in the table below can occur.

Message	Condition	Solution
Can't Write Data	When the communication fails between the controller and the XGT Panel.	Check the cable connection or the power of the XGT Panel.
Exceeded The Maximum Value!	When you input a value that exceeds the device size or data limit.	Input an exact value. Refer to the available device value range.

- If the device size is changed, the existing input condition and display condition are deleted.
- If the communication with the controllers fails while inputting or reading the data, only the background image is displayed on the XGT Panel. The number is not displayed.
- If you want to enter a decimal place, press the period on the keypad and then enter the numbers.

- **Use Cipher:** Set to encode the numeric value that a user inputs. The input value will appear as “*” in the interface.
- **Description:** Enter a description for the object.

- **Display:** The display settings for numeric input objects include the following.

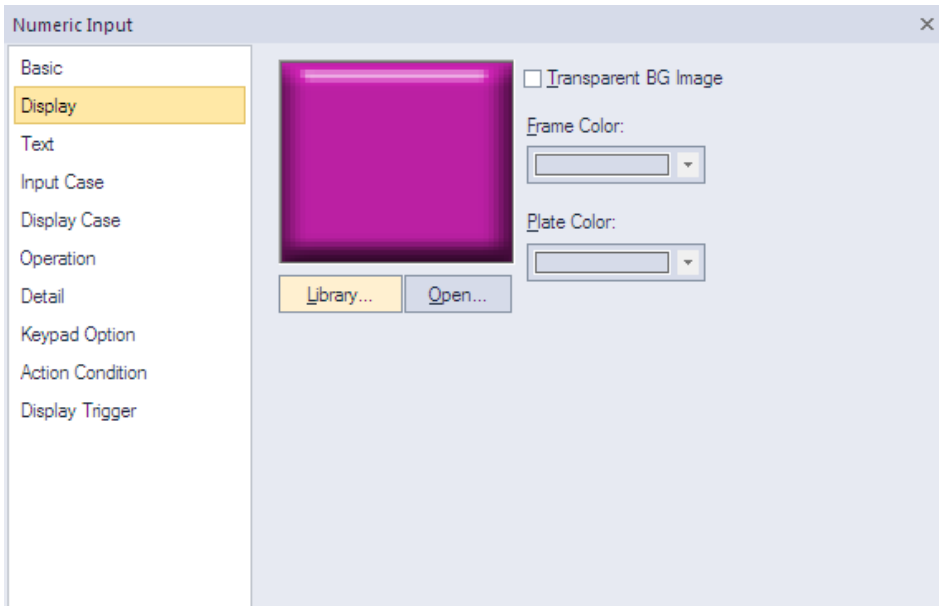

- **Library:** Click to select an image from the library.
- **Open:** Click to browse for images on your computer. When you select an image from your computer, it will be added to the image library automatically.
- **Transparent BG Image:** Click the checkbox to make the image background transparent. You cannot use a transparent background and the reverse image setting at the same time. You can use frame color and plate color only in case of vector image.

Frame Color	Set a frame color (only available with vector images).
Plate Color	Set a plate color (only available with vector images).

- **Text:** The text settings for numeric input objects include the following.

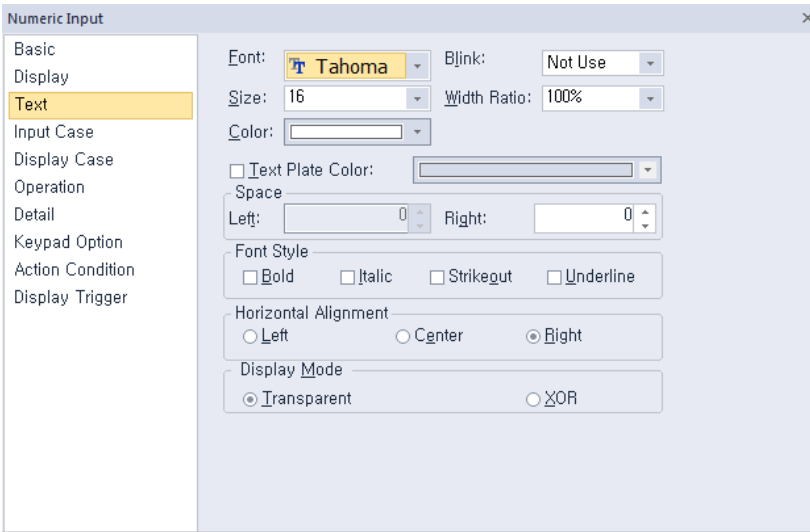

- **Font:** Select a font from the drop-down list.
- **Size:** Set a text size from the drop-down list or enter a value directly into the field.
- **Color:** Set a font color.
- **Blink:** Set a blink speed for the object:

Not use	The object will not blink.
Slow	The object will blink every three seconds.
Normal	The object will blink every two seconds.
Fast	The object will blink every second.

- **Width Ratio:** Expand or condense the text by selecting a ratio from the drop-down list or entering a value directly in to the field. You can set a rate of 1%-600%.
- **Text Plate Color:** Click to set the background color for figures.







- **Space:** Set the indent from the margin of the object. If you select left alignment, you can set the left indent. If you select right alignment, you can set the right indent.
- **Font Style:** Set a font style (bold, italic, strikeout, or underline). You can apply more than one option at a time.
- **Horizontal Alignment:** Set the horizontal alignment (Left, Center, or Right).
- **Display Mode:** Set to display the background color of figures in an XOR (exclusive Or) color or in transparent.

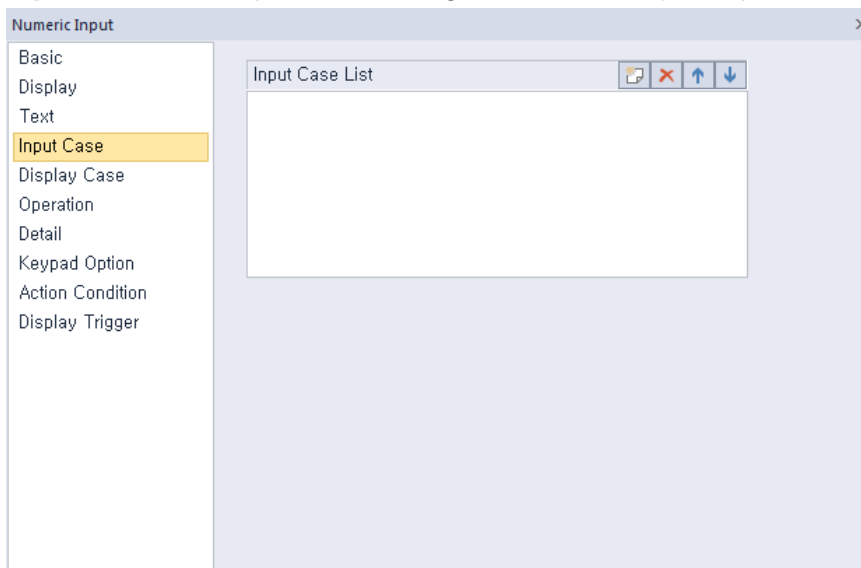

- **Input Case:** The input case settings for numeric input objects include the following.





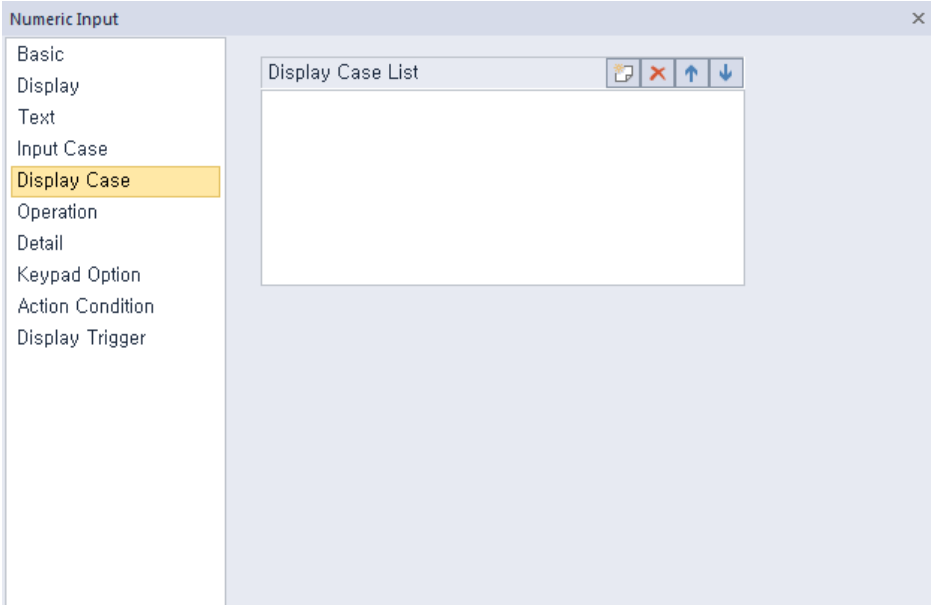

- **Input Case List:** Create, delete, or reorganize conditional expressions. You can create only one condition for numeric input.

 (Create)	Click to create a new range condition. You can create up to eight conditions. Clicking this button opens the Range Edit window, which allows you to create a condition. For more information, refer to <4.2.1.3 Understanding Constants and Data Types> .
 (Delete)	Click a condition and then click this icon to delete the condition.
 (Up)	Click a condition and then click this icon to move it higher up the list.
 (Down)	Click a condition and then click this icon to move it lower down the list.

- **Display Case:** The display case settings for numeric input objects include the following.



- **Display Case List:** Create, delete, or reorganize conditional expressions. If the device value meets multiple conditions, the display settings will be based on the first condition met.

 (Create)	Click to create a new range condition. You can create up to eight conditions. Clicking this button opens the Range Edit window, which allows you to create a condition. For more information, refer to <4.2.1.3 Understanding Constants and Data Types> .
 (Delete)	Click a condition and then click this icon to delete the condition.
 (Up)	Click a condition and then click this icon to move it higher up the list.
 (Down)	Click a condition and then click this icon to move it lower down the list.

<An example of an input condition or display condition>

\$V is a value of a device to monitor.

If an input condition is $\$V > 0$ and a display condition is as follows.

Setting	Condition	Background color	Text color	Blink
Condition 1	$200 \leq \$V < 300$	Blue	Yellow	Not use
Condition 2	$\$V > 1000$	Yellow	Black	Slow
General	Do not set.	Gray	Black	Not use

Changes of the number input on the XGT Panel according to the changes in the value of the device to monitor are as follow.

Status	Result
Device value = -200	Not supported

Status	Result
Device value = 199	
Device value = 250	
Device value = 1010	

Note

If a value of a device meets multiple conditions, it is displayed according to the settings of the first condition. In the example above, if the device value is 250, it will be displayed with the settings of the condition 1 although it meets both the condition 1 and the condition 2.

In the Range Edit window, you can adjust the settings for the plate color, text color, and blinking.

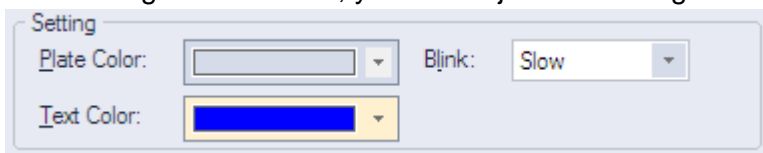

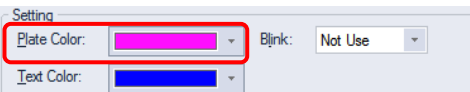
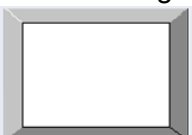
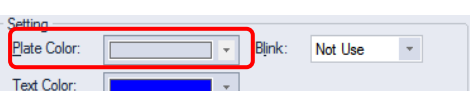
<p>Plate Color</p>	<p>Set the background color of an image selected in the Display settings. If a raster image is selected, this option is not available.</p> <div style="display: flex; flex-direction: column; align-items: center;"> <div style="display: flex; align-items: center; margin-bottom: 10px;">  <div style="margin-left: 20px;">  </div> </div> <p>A raster image is selected</p> <div style="display: flex; align-items: center;">  <div style="margin-left: 20px;">  </div> </div> <p>A vector image is selected</p> </div>
<p>Text Color</p>	<p>Set the color of a figure to be displayed in a numeric input object.</p>
<p>Blink</p>	<p>Set a blink speed for the object (Not use, Slow, Normal, fast).</p>

- **Operation:** The operation settings for numeric input objects include the following.

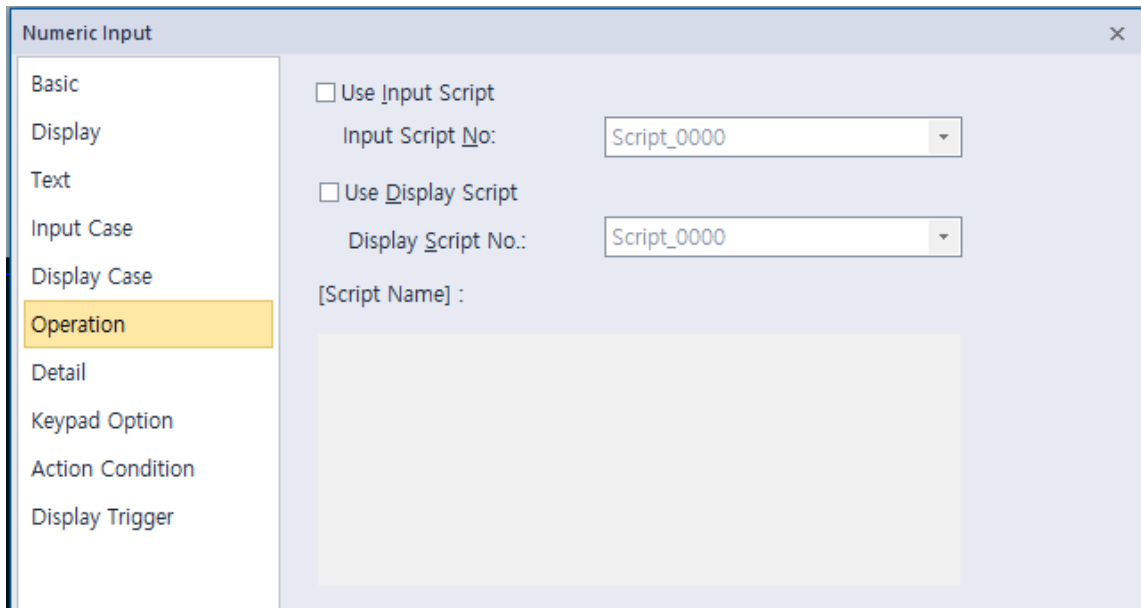

- **Use Input Script:** Set whether or not to use a script for numeric input.
- **Input Script No.:** Select a script for numeric input.
- **Use Display Script:** Set whether or not to use a script for numeric display.
- **Display Script No.:** Select a script for numeric display.
- **Input Script Name:** Expresses the most recent selected script contents.

Note

- Input Script Process:

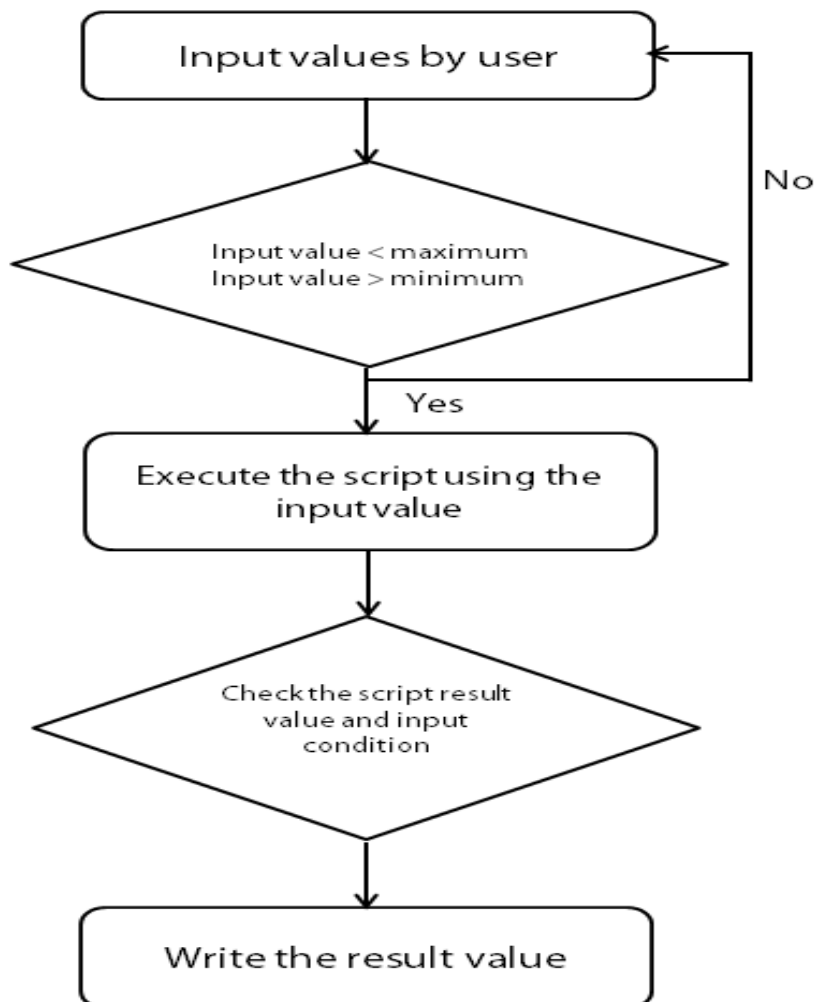

- Values entered by the user are always regarded as decimal numbers, so they are not converted.
- The maximum and minimum values differ according to the size and type of the device.
- When an action fails during script execution, the next action in the sequence is carried out.
- When an action fails during script execution and a temporary variable (\$ variable) is changed at the point of failure, the next step is carried out with the changed value.
- If a script result value does not meet the specified condition, the message "Invalid at Input Case" appears and the action fails.
- If communication fails while writing a value, the message "Can't Write Data" appears and the action fails.

- Output Script Process:

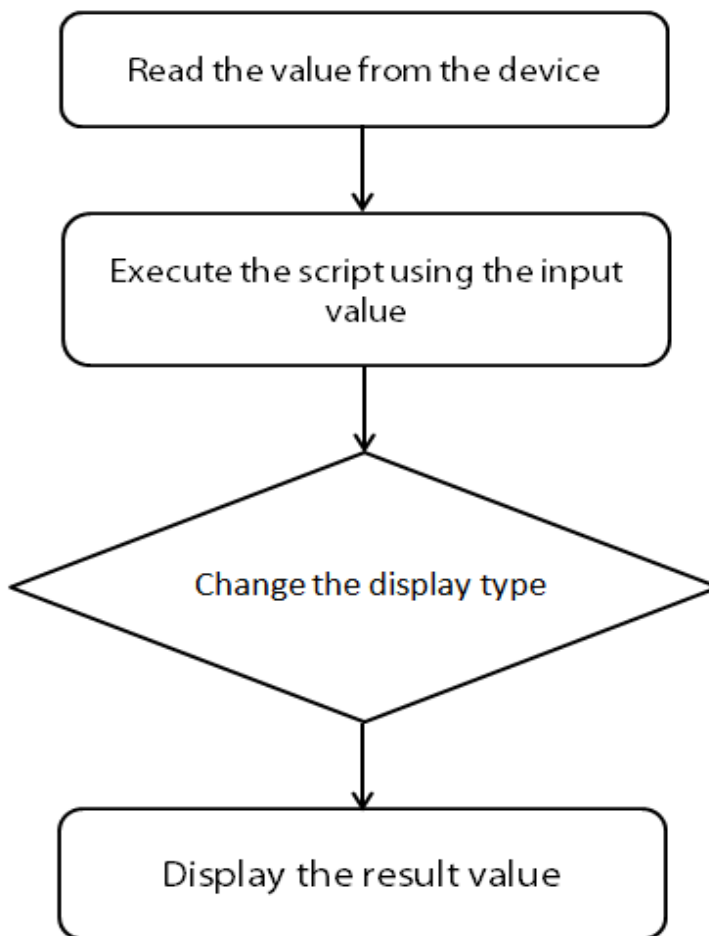

- If communication fails when a value is read from a device, the next action in a sequence is not performed.
- If an action fails during execution of the script, the next action in the sequence is carried out.
- When an action fails during script execution and a temporary variable (\$ variable) is changed at the point of failure, the next step is carried out with the changed value.
- If the device type does not match the BCD style, the type is replaced with a tilde (~).
- If the result value exceeds the number of figures you set, the extra numbers on the left are displayed are replaced with asterisks (*).
- If communication fails while writing a value, the message "Can't Write Data" appears and the action fails.

- **Detail:** The detail settings for numeric input objects include the following.

Numeric Input

Basic

Display

Text

Input Case

Display Case

Operation

Detail

Keypad Option

Action Condition

Display Trigger

Security Level: 0 Zero Fill

Offset Zero Display

Device(E): D

Read

Device(R): D

Write Check

Device(W): D

Write Device Off: 1 sec

Use Operation Log

- **Security Level:** Set the security level for the object. The higher the security level, the shorter the authorization time when the password is entered. When the authorization time expires, the user must enter the password again to use the object.
- **Zero Fill:** If you have selected right justification, select this option to insert zeroes (0) before the number.

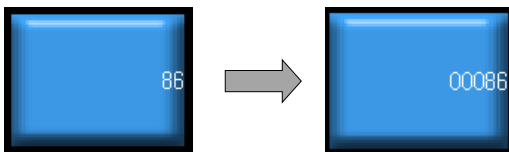

- **Zero Display:** Set whether or not to show zeroes. If you do not set this option, the object displays nothing when the device value is 0.
- **Offset:** Click the checkbox to use the offset function. You can offset the device address based on the value of the offset device. For example, if the starting device address is P100, XP-Builder reads the value from the offset device and offsets the address by that value. If the offset value is 10, for example, then the referenced device address is P110.

The offset function behaves differently if a read device is set. When a read device is set, the offset is only applied to the writing device. If a read device is not set, the offset is applied to both read and write devices.

Numeric Input

Basic

Display

Text

Input Case

Display Case

Operation

Detail

Keypad Option

Action Condition

Display Trigger

Security Level: 3 Zero Fill

Offset in [Write] Operation Zero Display

Device(E):

Read

Device(R): D HK0123

Write Check

Device(W): D

Write Device Off: 1 sec

Use Operation Log

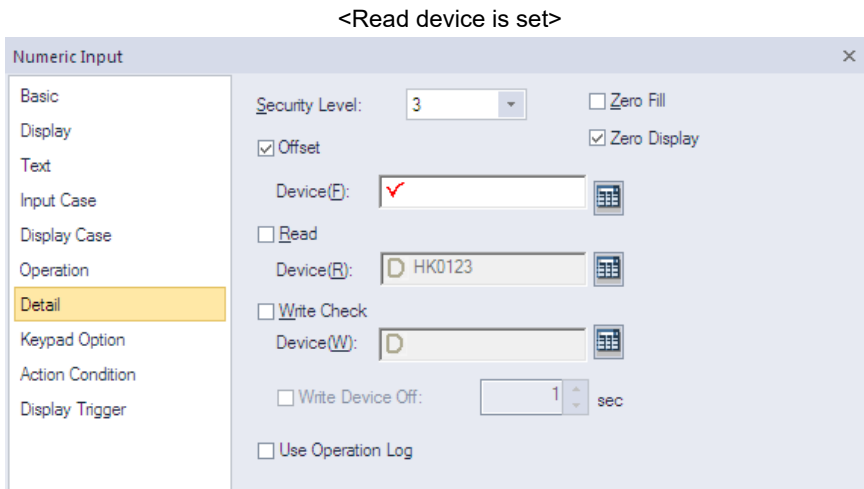

<Read device is not set>

- **Offset Device:** Enter a device or tag address directly into the input field or click the keypad icon to the right to specify a device or tag address. When you click the keypad icon to open the Device window, you can also specify network settings, if necessary.
- **Read Device:** Set whether or not to use a separate device for reading data. When you set the read device, even if it is same as the reference device in the Basic setting, the offset is only applied to the write device. If the read device is different from the reference device, the value is written to the write device during the input process. In contrast, when the input process is stopped, the value is read from the read device and the data is displayed.

For example, if the device value is as follows,

Type	Device address	Device value
Reference Device	D10	100
Read Device	D20	200

The result of writing 500 to the numeric input object is as follows.

Condition	Value from controller		Value displayed in XGT Panel
Read not set	D10	500	500
	D20	200	
Read set	D10	500	200
	D20	200	

The values in the controller are same, but the data displayed in the XGT Panel is different.

- **Write Check Device:** Set a device to verify the returned device value. Set this option when the bit device is ON after inputting the number.
- **Write Device Off:** Set when to turn off the write check device, if the data cannot be verified.
- **Use Operation Log:** Set to allow the device to be monitored in an operation log. XP30-BTE, XP30-TTE, XP40-TTE, XP50-TTE is not supported.

Clear Type	Set whether or not to clear input data automatically when switching to input mode.	
	Auto Clear OFF	Shows the previous data in input mode.
	Auto Clear On	Clears input data automatically when switching to input mode.

- **Keypad Settings:** Set the key window options for data input. If you don't use the key window, you can also set the key switches using the special switch object on the same screen.

Keypad Type	Set whether or not to use the Window Keypad Screen.
Use Keypad set in Input Object	Set whether or not to use the keypad specified in the key window settings. Enter the number of the key window or click [Browse] to locate the key window. If this option is not selected, the keypads set in [COMMON] ► [Project Property Setting] ► [Key Window Settings] will be used.
Use User Keypad Position	Set whether or not to specify a location for the key window. Set the coordinates for the X and Y axes. If you do not specify the location, the key window will appear at the upper left or upper right of the screen.

- **Use Auto Cursor:** Set whether or not to use the auto cursor function. When the user touches [Enter] while entering data in a key window, the cursor moves to the next input field automatically.

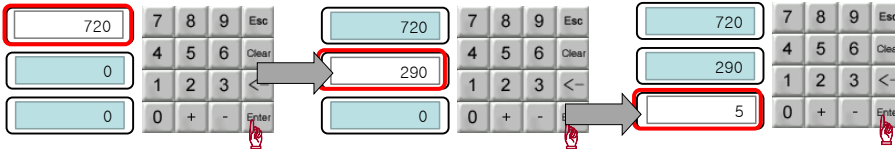

Input Order	Specify the sequence number of the window to control cursor movement.
Use Group	Specify the same sequence number of a group of windows to control cursor movement.

- **Use Interlock:** Set to prevent input when the interlock device meets the specified condition (device ON or OFF). The input cursor will skip the locked unit and move automatically to the next unit in the sequence.

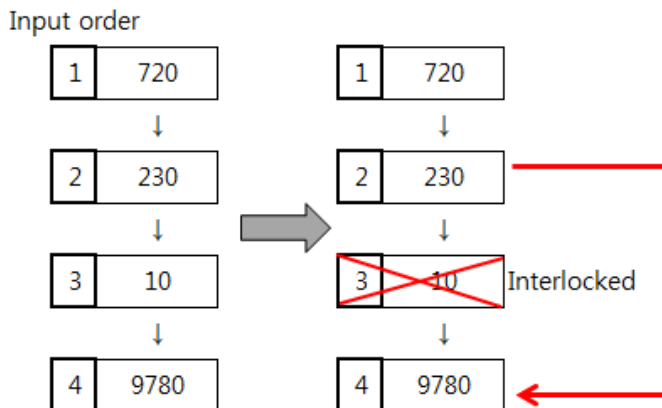

- **Action Condition:** The action condition settings for numeric input objects include the following.

- **Use Condition:** Set whether or not to specify a condition for the action.
- **Type:** Set a type of condition to specify.

Bit On	The action is performed when the device is switched on.
Bit Off	The action is performed when the device is switched off.
Range	The action is performed when the value falls within the specified range.
Multi Bit	The action is performed when the logical operation result of multiple devices is met.

- **Device:** Enter a device or tag address directly into the input field or click the keypad icon to the right to specify a device or tag address. When you click the keypad icon to open the Device window, you can also specify network settings, if necessary.
- **Range:** If you select the range condition, specify the range.

Size	16 bit or 32 bit.
Type	Signed decimal, unsigned decimal, BCD, or float
Exp.	Click to designate the expression as conditional.

- **Multi Bit:** If you select the multi bit condition, specify the number of bits and click [Setting] to specify the bit conditions.

- **Display Trigger:** The display trigger settings for numeric input objects include the following.

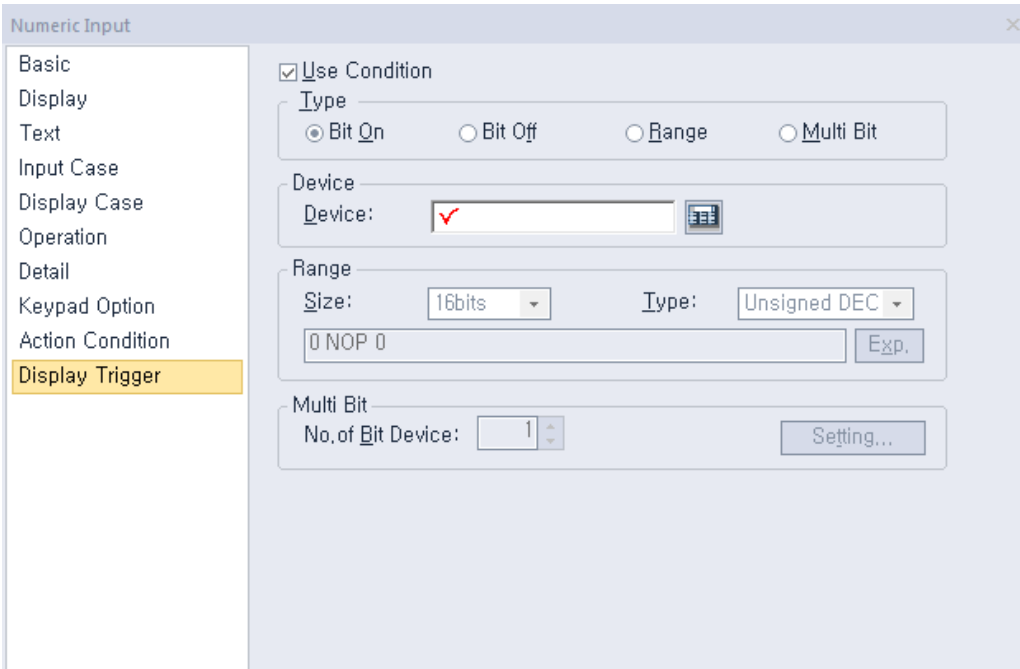

- **Use Condition:** Set whether or not to specify a condition for the action.
- **Type:** Set a type of condition to specify.

Bit On	The action is performed when the device is switched on.
Bit Off	The action is performed when the device is switched off.
Range	The action is performed when the value falls within the specified range.
Multi Bit	The action is performed when the logical operation result of multiple devices is met.

- **Device:** Enter a device or tag address directly into the input field or click the keypad icon to the right to specify a device or tag address. When you click the keypad icon to open the Device window, you can also specify network settings, if necessary.

- **Range:** If you select the range condition, specify the range.

Size	16 bit or 32 bit.
Type	Signed decimal, unsigned decimal, BCD, or Float
Exp.	Click to designate the expression as conditional.

- **Multi Bit:** If you select the multi bit condition, specify the number of bits and click [Setting] to specify the bit conditions.

4.3.4.2 Numeric Display

This section describes available settings for numeric display objects.

- **Basic:** The basic settings for numeric display objects include the following.

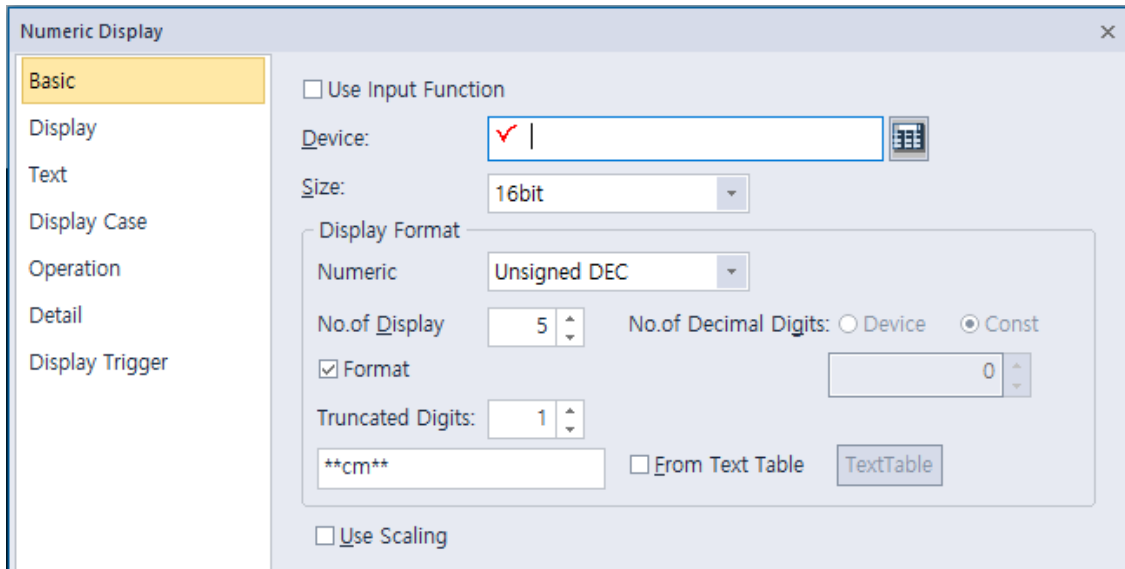

- **Device:** Enter a device or tag address directly into the input field or click the keypad icon to the right to specify a device or tag address. When you click the keypad icon to open the Device window you can also specify network settings, if necessary.
- **Use Input Function:** Check this option to change the numeric display object to a numeric input object. Object property setting options automatically change to fit the object type. Refer to **<4.3.4.1 Numeric Input>** for detailed information.
- **Size:** Set a data size (16 bit upper byte, 16 bit lower byte, 16 bit, or 32 bit). If you change the data size of an existing object, the input and display conditions will automatically change to match the new data size.
XP30-BTE, XP-30TTE, XP40-TTE, and the XP50-TTE do not support 16bit upper/lower byte.
- **Display Format:** Set the display format.

Numeric Format	Set the number format.	
	Format	Example
	Signed decimal	-2184
	Unsigned decimal	2184
	Octal	4210
	Hexadecimal	888
	Binary	10010001000
	BCD	888
	Float	2184.0

The Float format can be selected only when the data size is 32 bit.

No. of Display Digits	Set how many digits to display (up to 64). If the number of digits is less than the capacity of the device, empty spaces are filled with placeholders (“*”). If the device value cannot be displayed in BCD format, it is expressed as “~”.

<p>No. of Decimal Digits</p>	<p>Set how many places to put to the right of the decimal point when you select formats other than binary, octal, and hexadecimal numbers.</p> <table border="1" data-bbox="560 387 1342 533"> <tr> <td>Fixed</td> <td>Enter the number of decimal digits directly.</td> </tr> <tr> <td>Device</td> <td>The number of decimal digits changes dynamically according to the device value.</td> </tr> </table>	Fixed	Enter the number of decimal digits directly.	Device	The number of decimal digits changes dynamically according to the device value.						
Fixed	Enter the number of decimal digits directly.										
Device	The number of decimal digits changes dynamically according to the device value.										
<p>Format</p>	<p>Set the display format of numbers and texts. User can specify the text format yourself or choose from the text table. You can enter text directly, but numbers are marked with *. The number of * is the number of numbers and is determined by the number of truncated digits.</p> <div data-bbox="539 725 1378 893" style="border: 1px solid #ccc; padding: 5px; margin-bottom: 10px;"> <input checked="" type="checkbox"/> Format 0 Truncated Digits: <input style="width: 50px;" type="text" value="2"/> <input type="text"/> <input type="checkbox"/> From Text Table <input type="button" value="TextTable"/> </div> <table border="1" data-bbox="560 898 1342 1111"> <tr> <td>Directly</td> <td>The text format is manually entered by the user.</td> </tr> <tr> <td>From Text Table</td> <td>Select the text format from the text table. In this case, you can change the text format according to the language switch.</td> </tr> </table> <p>Example)</p> <div data-bbox="539 1149 1362 1447" style="border: 1px solid #ccc; padding: 5px; margin-bottom: 10px;"> Display Format Numeric: Unsigned DEC No. of Display: <input style="width: 50px;" type="text" value="5"/> No. of Decimal Digits: <input type="radio"/> Device <input checked="" type="radio"/> Const <input checked="" type="checkbox"/> Format 0 Truncated Digits: <input style="width: 50px;" type="text" value="1"/> <input type="text" value="**cm**"/> <input type="checkbox"/> From Text Table <input type="button" value="TextTable"/> </div> <p>In the case of setting as above, the result displayed on the XGT Panel differs depending on the device.</p> <ul style="list-style-type: none"> • If device value is 12345 <div data-bbox="555 1563 1114 1753" style="margin-left: 40px;"> <table border="1" style="border-collapse: collapse; text-align: center;"> <tr> <td style="width: 20px;">1</td> <td style="width: 20px;">2</td> <td style="width: 20px;">3</td> <td style="width: 20px;">4</td> <td style="width: 20px;">5</td> <td style="width: 20px;"></td> </tr> </table> <p style="margin-left: 40px;">Numbers: 5</p> <p style="margin-left: 40px;">Truncated digits: 1</p> <p style="margin-left: 100px;">→ 12cm 34mm</p> </div>	Directly	The text format is manually entered by the user.	From Text Table	Select the text format from the text table. In this case, you can change the text format according to the language switch.	1	2	3	4	5	
Directly	The text format is manually entered by the user.										
From Text Table	Select the text format from the text table. In this case, you can change the text format according to the language switch.										
1	2	3	4	5							



- If device value is 12345678

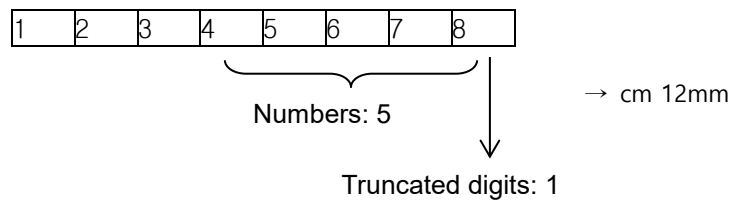

Basically, numbers are discarded from the back of the input device value, but if the text format is set and the number of device values is larger than the set number, the numbers are discarded from the front.

Note

When the text format is specified in the text table, the text format (bold, strikethrough, etc.), color and font of the [Text Table] are not applied. In this case, each property set in the [Text] tab is applied.

Truncated Digits

Set a number of digits to truncate from the numerical value. Truncation occurs in order from the most significant bit (MSB) to the least significant bit (LSB).

- **Use Scaling:** When a user scales and inputs random values to an established PLC device address, this function can be applied. Actual PLC values and displayable values differ by data size and display type. If the value input by a user exceeds the maximum value, the maximum value is input to the device instead. If the value input by a user is lower than the minimum value, the minimum value is input to the device instead.

Min Device Value	Input the minimum data value of PLC device to scale. Device: Able to set the minimum value as the device address. Constant: Able to set the minimum value as constant according to data size and numeric type.																								
Max Device Value	Input the maximum data value of PLC device to scale. Device: Able to set the maximum value as the device address. Constant: Able to set the maximum value as constant according to data size and numeric type.																								
Min. Input Value	Input the minimum data value to be displayed at scale. Device: Able to set the minimum value as the device address. Constant: Able to set the minimum value as constant according to data size and numeric type.																								
Max. Input Value	Input the maximum data value to be displayed at scale. Device: Able to set the maximum value as the device address. Constant: Able to set the maximum value as constant according to data size and numeric type.																								
Use Round Off	<p>This option activates or deactivates rounding up to the scaled value.</p> <p style="text-align: center;">[Device value] → [Indicated value]</p> <table border="1" style="margin-left: auto; margin-right: auto;"> <tr><td>-10</td><td>-2</td></tr> <tr><td>50</td><td>10 (decimal point to be always discarded)</td></tr> <tr><td>53</td><td>10</td></tr> <tr><td>86</td><td>17 (decimal point to be always discarded)</td></tr> <tr><td>100</td><td>20</td></tr> <tr><td>204</td><td>40 (decimal point to be always discarded)</td></tr> </table> <p>If "Rounding up" is set, the followings are successful.</p> <p style="text-align: center;">[Device value] → [Indicated value]</p> <table border="1" style="margin-left: auto; margin-right: auto;"> <tr><td>-10</td><td>-2</td></tr> <tr><td>50</td><td>10 (decimal point to be rounded up)</td></tr> <tr><td>53</td><td>11</td></tr> <tr><td>86</td><td>17 (decimal point to be rounded up)</td></tr> <tr><td>100</td><td>20</td></tr> <tr><td>204</td><td>41 (decimal point to be rounded up)</td></tr> </table>	-10	-2	50	10 (decimal point to be always discarded)	53	10	86	17 (decimal point to be always discarded)	100	20	204	40 (decimal point to be always discarded)	-10	-2	50	10 (decimal point to be rounded up)	53	11	86	17 (decimal point to be rounded up)	100	20	204	41 (decimal point to be rounded up)
-10	-2																								
50	10 (decimal point to be always discarded)																								
53	10																								
86	17 (decimal point to be always discarded)																								
100	20																								
204	40 (decimal point to be always discarded)																								
-10	-2																								
50	10 (decimal point to be rounded up)																								
53	11																								
86	17 (decimal point to be rounded up)																								
100	20																								
204	41 (decimal point to be rounded up)																								

For example, if the maximum display value is 1000, the minimum value is 0, the device maximum value is 100, and the minimum value is 0, and the actual device value is 100, it operates as follows.

$$\{ (\text{Max out} - \text{min out}) / (\text{max dev.} - \text{min dev.}) \} * \text{Device}$$

$$\{ (100 - 0) / (100 - 0) \} * 100 = 10$$

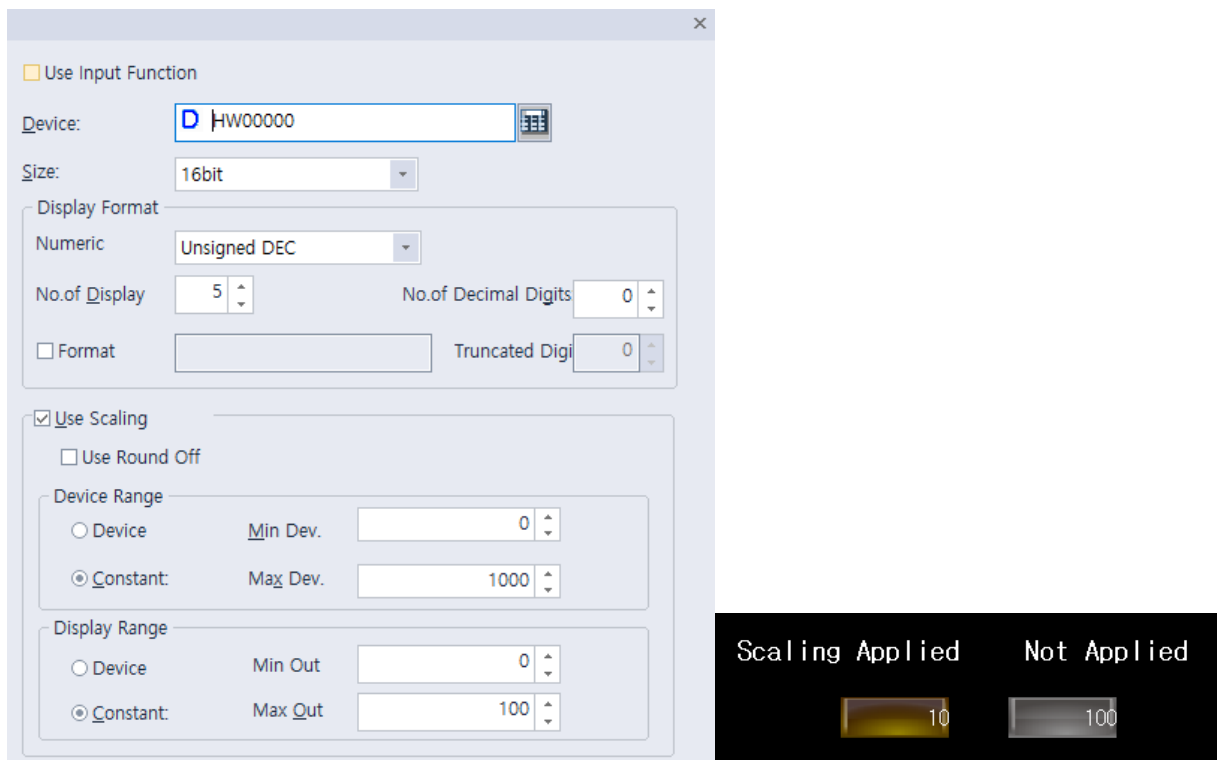

Note

- The available device value range and displayable data value range differ by size and type of the device, as described in the following table.

Device Size	Device Type	Minimum	Maximum
16 bit upper type	Signed decimal	-128	127
	Unsigned decimal, binary, octal, hexadecimal	0	255
16 bit lower type	Signed decimal	-128	127
	Unsigned decimal, binary, octal, hexadecimal	0	255
16bit	Signed decimal	-32768	32767
	Unsigned decimal	0	65535
	BCD	0	9999
32 bit	Signed decimal	-2147483648	2147483647
	Unsigned decimal	0	4294967295
	BCD	0	99999999

- When you input a number, the following errors can occur:

Message	Condition	Solution
---------	-----------	----------

Can't Write Data	When the communication fails between the controller and XGT Panel.	Check the cable connection or the power of XGT Panel.
Exceeded The Maximum Value!	When you input a value that exceeds the device size or data limit.	Input an exact value. Refer to the available device value range.

- If the device size is changed, the existing input condition and display condition are deleted.
- If the communication with the controllers fails while inputting or reading the data, only the background image is displayed on the XGT Panel. The number is not displayed.
- If you want to enter a decimal place, press the period on the keypad and then enter the numbers.

– **Description:** Enter a description for the object.

- **Display:** The display settings for numeric display objects include the following.

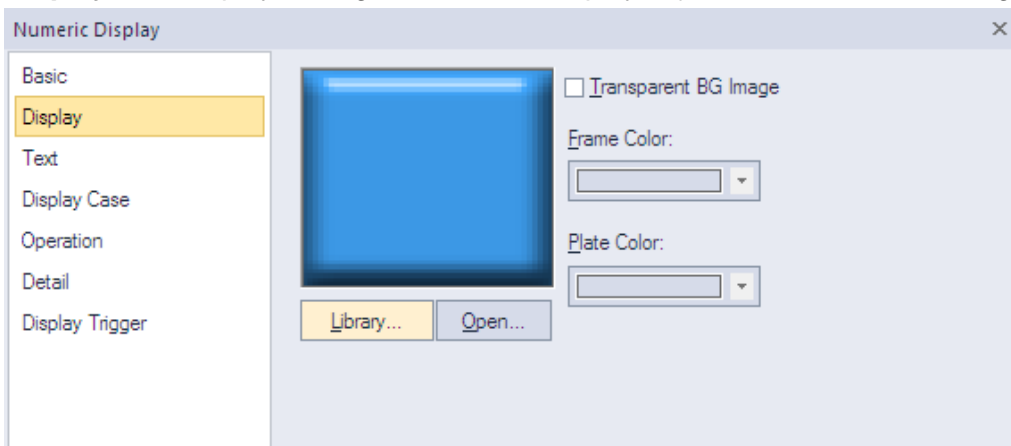

- **Library:** Click to select an image from the library.
- **Open:** Click to browse for images on your computer. When you select an image from your computer, it will be added to the image library automatically.
- **Transparent BG Image:** Click the checkbox to make the image background transparent.

Frame Color	Set a frame color (only available with vector images).
Plate Color	Set a plate color (only available with vector images).

- **Text:** The text settings for numeric display objects include the following.

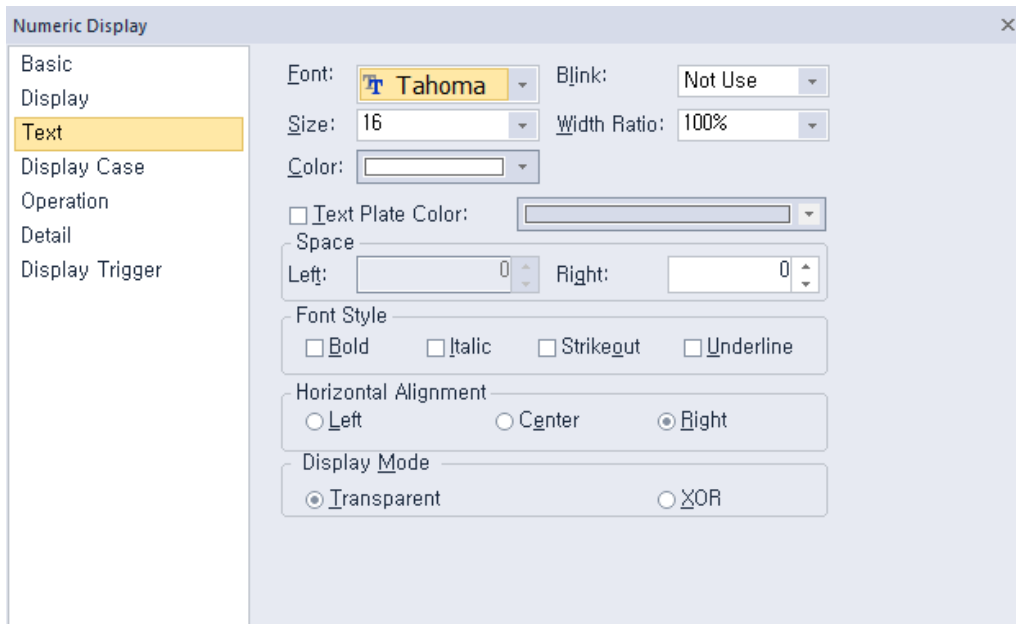

- **Font:** Select a font from the drop-down list.
- **Size:** Set a text size from the drop-down list or enter a value directly into the field.
- **Color:** Set a font color.
- **Blink:** Set a blink speed for the object:

Not use	The object will not blink.
Slow	The object will blink every three seconds.
Normal	The object will blink every two seconds.
Fast	The object will blink every second.

- **Width Ratio:** Expand or condense the text by selecting a ratio from the drop-down list or entering a value directly in to the field. You can set a rate of 1%-600%.
- **Text Plate Color:** Click to set the background color for figures.

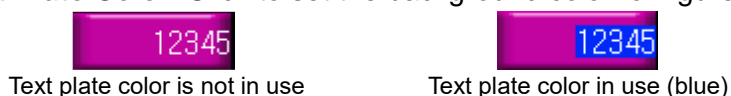



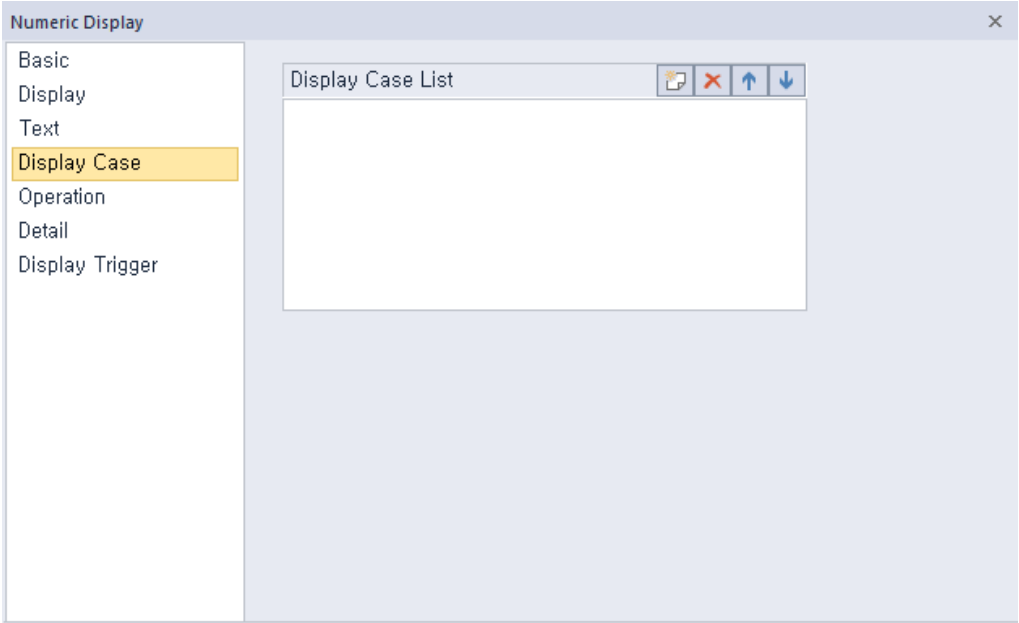

- **Space:** Set the indent from the margin of the object. If you select left alignment, you can set the left indent. If you select right alignment, you can set the right indent.
- **Font Style:** Set a font style (bold, italic, strikeout, or underline). You can apply more than one option at a time.
- **Horizontal Alignment:** Set the horizontal alignment (Left, Center, or Right).
- **Display Mode:** Set an option for the color of the message based on the background color.

Transparent	Display the message transparently, in contrast to the background image.
XOR	Display the message in a color that is easily distinguished from the background image.

- **Display Case:** The display case settings for numeric display objects include the following.



- **Display Case List:** Create, delete, or reorganize conditional expressions. If the device value meets multiple conditions, the display settings will be based on the first condition met.

 (Create)	Click to create a new range condition. You can create up to eight conditions. For more information, <4.2.1.3 Understanding Constants and Data Types>.
 (Delete)	Click a condition and then click this icon to delete the condition.
 (Up)	Click a condition and then click this icon to move it higher up the list.
 (Down)	Click a condition and then click this icon to move it lower down the list.

<An example of an input condition or display condition>



\$V is a value of a device to monitor.

If an input condition is $\$V > 0$ and a display condition is as follows.

Setting	Condition	Background color	Text color	Blink
Condition 1	$200 \leq \$V < 300$	Blue	Yellow	Not use
Condition 2	$\$V > 1000$	Yellow	Black	Slow
General	Do not set.	Gray	Black	Not use

Changes of the number input on the XGT Panel according to the changes in the value of the device to monitor are as follow.

Status	Result
Device value = -200	Not supported

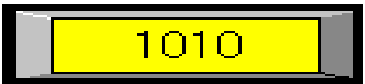
Status	Result
Device value = 199	
Device value = 250	
Device value = 1010	

Note

If a value of a device meets multiple conditions, it is displayed according to the settings of the first condition. In the example above, if the device value is 250, it will be displayed with the settings of the condition 1 although it meets both the condition 1 and the condition 2.

In the Range Edit window, you can adjust the settings for the plate color, text color, and blinking.

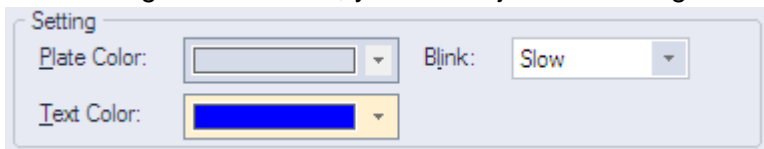

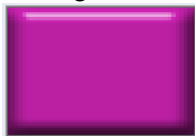
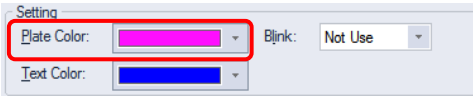
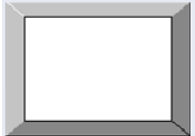
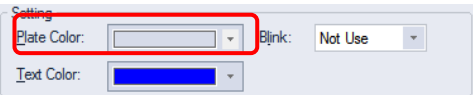
<p>Plate Color</p>	<p>Set the background color of an image selected in the Display settings. If a raster image is selected, this option is not available.</p> <div data-bbox="504 1151 699 1317">  <p>Library... Open...</p> </div> <div data-bbox="719 1223 1193 1317">  </div> <p>A raster image is selected</p> <div data-bbox="504 1361 699 1527">  <p>Library... Open...</p> </div> <div data-bbox="719 1433 1193 1527">  </div> <p>A vector image is selected</p>
<p>Text Color</p>	<p>Set the color of a figure to be displayed in a numeric input object.</p>
<p>Blink</p>	<p>Set a blink speed for the object (Not use, Slow, Normal, Fast).</p>

- **Operation:** The operation settings for numeric display objects include the following.



- **Use Script:** Click the checkbox to use a script with the object.
- **Select Script:** Select a script from the drop-down list.
- **Script:** When you select a script, it appears here. To modify a script, refer to <4.2 >.

- **Detail:** The detail settings for numeric display objects include the following.

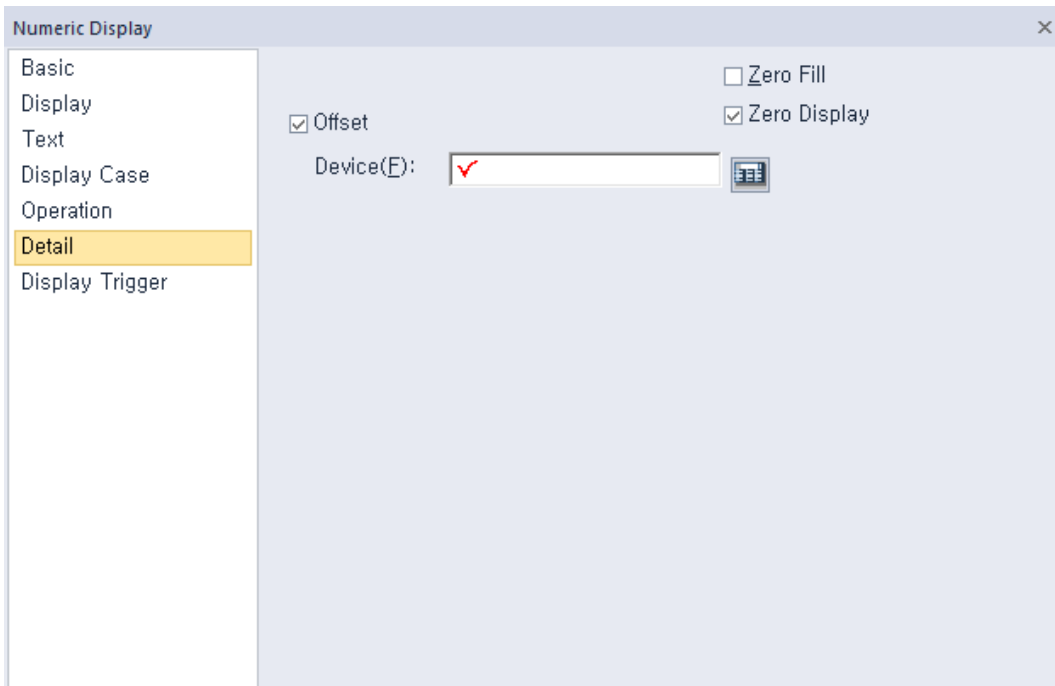

- **Offset:** Click the checkbox to use the offset function. You can offset the device address based on the value of the offset device. For example, if the starting device address is P100, XP-Builder reads the value from the offset device and offsets the address by that value. If the offset value is 10, for example, then the referenced device address is P110.
- **Device:** Enter a device or tag address directly into the input field or click the keypad icon to the right to specify a device or tag address. When you click the keypad icon to open the Device window you can also specify network settings, if necessary.
- **Zero Fill:** If you have selected right justification, select this option to insert zeroes (0) before the number.

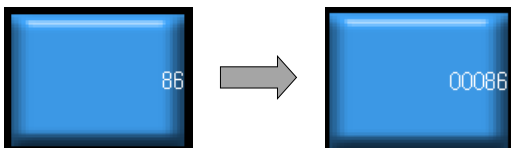

- **Zero Display:** Set whether or not to show zeroes. If you do not set this option, the object displays nothing when the device value is 0.

- **Display Trigger:** The display trigger settings for numeric display objects include the following.

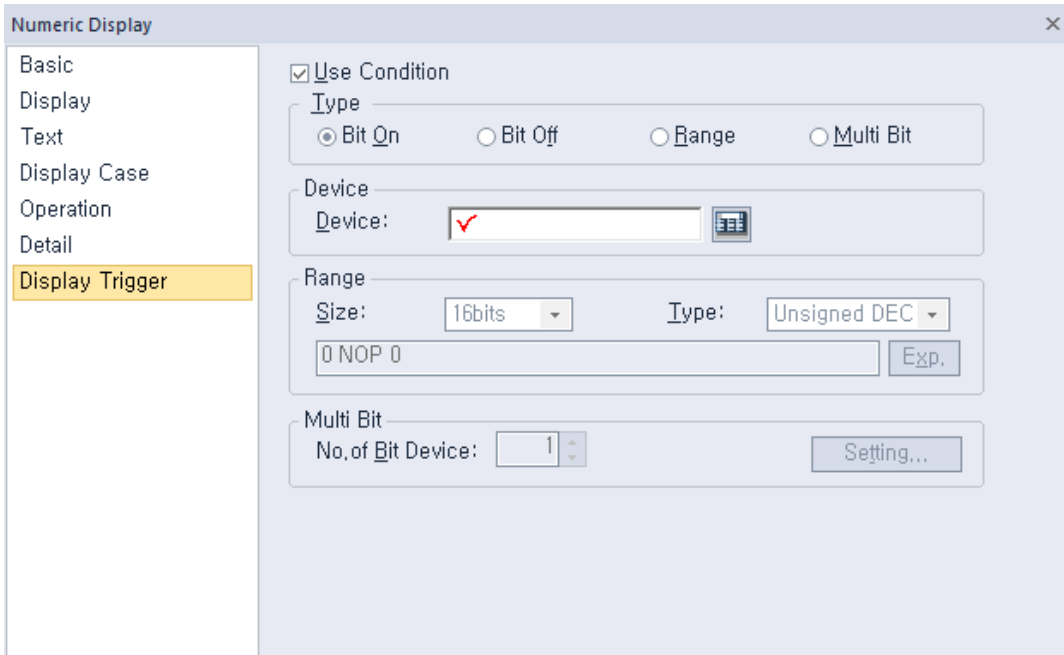

- **Use Condition:** Set whether or not to specify a condition for the action.
- **Type:** Set a type of condition to specify.

Bit On	The action is performed when the device is switched on.
Bit Off	The action is performed when the device is switched off.
Range	The action is performed when the value falls within the specified range.
Multi Bit	The action is performed when the logical operation result of multiple devices is met.

- **Device:** Enter a device or tag address directly into the input field or click the keypad icon to the right to specify a device or tag address. When you click the keypad icon to open the Device window, you can also specify network settings, if necessary.
- **Range:** If you select the range condition, specify the range.

Size	16 bit or 32 bit.
Type	Signed decimal, unsigned decimal, BCD, or float.
Exp.	Click to designate the expression as conditional.

- **Multi Bit:** If you select the multi bit condition, specify the number of bits and click [Setting] to specify the bit conditions.

4.3.4.3 Text Input

You can write the entered texts in the word device in ASCII code. This section describes available settings for text input objects.

- **Basic:** The basic settings for text input objects include the following.

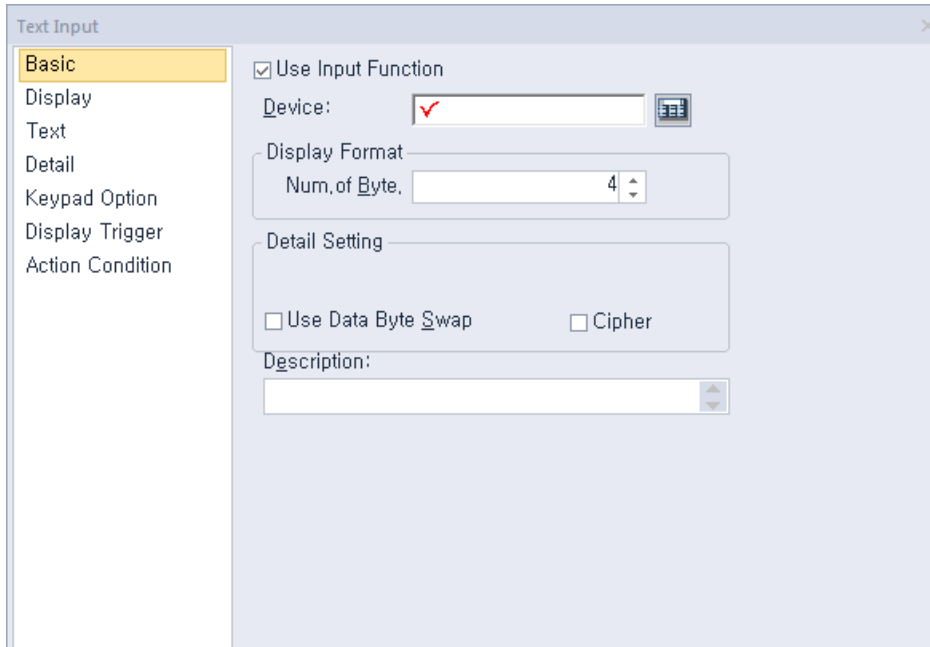

- **Use Input Function:** Uncheck this option to change the text input object to a text display object. Object property setting options automatically change to fit the object type. Refer to **<4.3.4.4 Text Display>** for detailed information.

- **Device:** Enter a device or tag address directly into the input field or click the keypad icon to the right to specify a device or tag address. When you click the keypad

- **Display Format:** Set the display format.

No. of BYTE	Set the number of characters to display (2 to 64).
-------------	--

- **Use Data Byte Swap:** Set to change output data into word form. For example, if ABCD is input, BADC is output in the device.

- **Use Cipher:** Set to encode the numeric value that a user inputs. The input value will appear as “*” in the interface.

- **Description:** Enter a description for the object.

Note

- Spaces are counted in the number of bytes allowed for text input.
- 16 bit word devices allow entry of double-byte characters.
- The starting address of the specified reference device is the memory location for text input. The amount of text that can be input is the same as the volume of the memory location.
- An odd number of characters can be input and the remaining areas will be filled with 0. For example, if the number of characters is set to 4 and only 3 characters are input, the remaining area in the memory will be filled with 0.

- **Display:** The display settings for text input objects include the following.

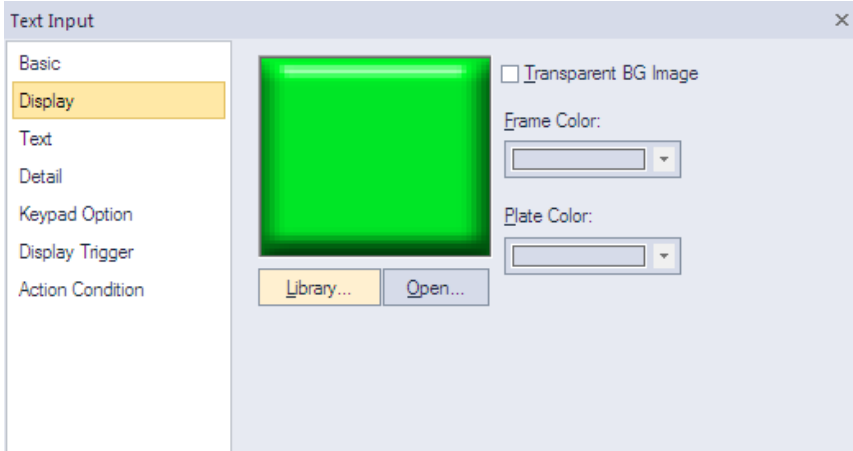

- **Library:** Click to select an image from the library.
- **Open:** Click to browse for images on your computer. When you select an image from your computer, it will be added to the image library automatically.
- **Transparent BG Image:** Click the checkbox to make the image background transparent.

Frame Color	Set a frame color (only available with vector images).
Plate Color	Set a plate color (only available with vector images).

- **Text:** The text settings for text input objects include the following.

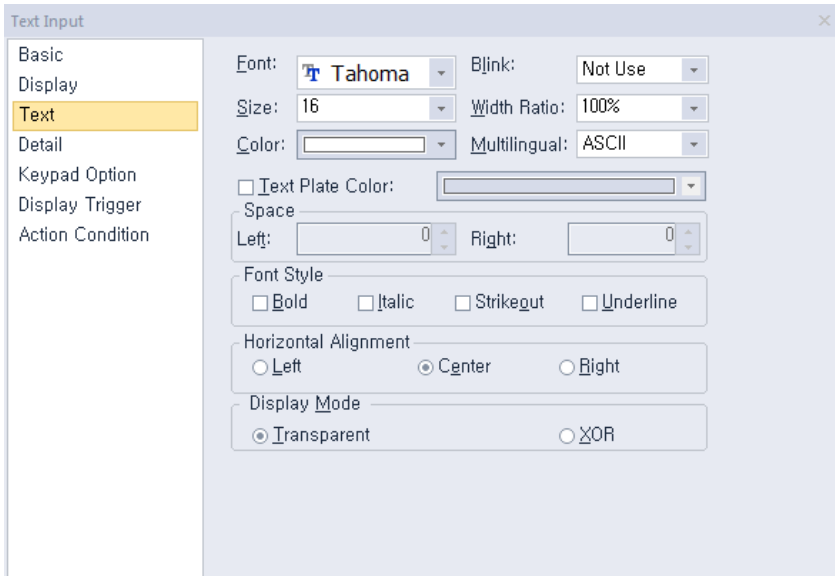

- **Font:** Select a font from the drop-down list.
- **Size:** Set a text size from the drop-down list or enter a value directly into the field.
- **Color:** Set a font color.
- **Blink:** Set a blink speed for the object:

Not use	The object will not blink.
Slow	The object will blink every three seconds.

Normal	The object will blink every two seconds.
Fast	The object will blink every second.

- **Width Ratio:** Expand or condense the text by selecting a ratio from the drop-down list or entering a value directly in to the field. You can set a rate of 1%-600%.
- **Text Plate Color:** Click to set the background color for figures.



- **Multilingual:** Set the display text type. You can display text to ASCII or Korean.
- **Space:** Set the indent from the margin of the object. If you select left alignment, you can set the left indent. If you select right alignment, you can set the right indent.
- **Font Style:** Set a font style (bold, italic, strikeout, or underline). You can apply more than one option at a time.
- **Horizontal Alignment:** Set the horizontal alignment (Left, Center, or Right).
- **Display Mode:** Set an option for the color of the message based on the background color.

Transparent	Display the message transparently, in contrast to the background image.
XOR	Display the message in a color that is easily distinguished from the background image.

- **Detail:** The detail settings for text input objects include the following.

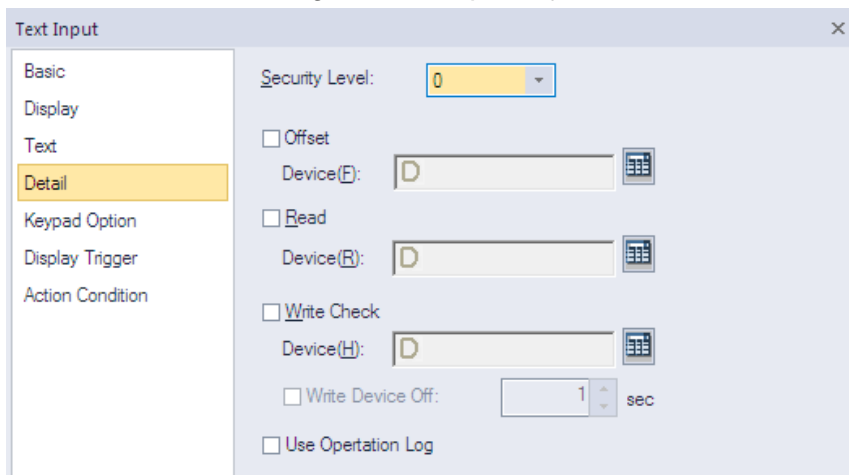

- **Security Level:** Set the security level for the object. The higher the security level, the shorter the authorization time when the password is entered. When the authorization time expires, the user must enter the password again to use the object.
- **Offset:** Click the checkbox to use the offset function. You can offset the device address based on the value of the offset device. For example, if the starting device address is P100, XP-Builder reads the value from the offset device and offsets the address by that value. If the offset value is 10, for example, then the referenced device address is P110.
The offset function behaves differently if a read device is set. When a read device is set, the offset is only applied to the writing device. If a read device is not set, the offset is applied to both read and write devices.

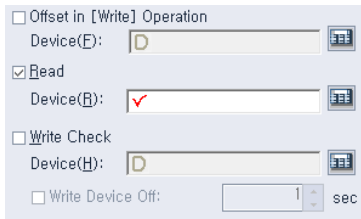

<Read device set>

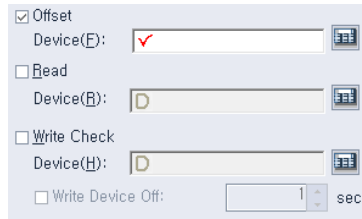

<Read device not set>

- **Offset Device:** Enter a device or tag address directly into the input field or click the keypad icon to the right to specify a device or tag address. When you click the keypad icon to open the Device window, you can also specify network settings, if necessary.
- **Read Device:** Set whether or not to use a separate device for reading data. When you set the read device, even if it is same as the reference device in the Basic setting, the offset is only applied to the write device. If the read device is different from the reference device, the value is written to the write device during the input process. In contrast, when the input process is stopped, the value is read from the read device and the data is displayed.

For example, if the device value is as follows:

Type	Device address	Device value
Reference Device	D10	0 (0x00)
Reading Device	D20	CD (0x4443)

The result of writing AB(0x4241) to the numeric input object is as follows:

Condition	Value from controller		Value displayed in XGT Panel
Read not set	D10	AB(0x4241)	AB(0x4241)
	D20	CD(0x4443)	
Read set	D10	AB(0x4241)	CD(0x4443)
	D20	CD(0x4443)	

The values in the controller are same, but the data displayed in the XGT Panel is different.

- **Write Check Device:** Set a device to verify the returned device value. Set this option when the bit device is On after inputting the number.
- **Write Device Off:** Set when to turn off the write check device, if the data cannot be verified.
- **Use Log:** Set to allow the device to be monitored in an operation log.
XP30-BTE, XP30-TTE, XP40-TTE, XP50-TTE is not supported.

- **Keypad Option:** The keypad options settings for text input objects include the following.

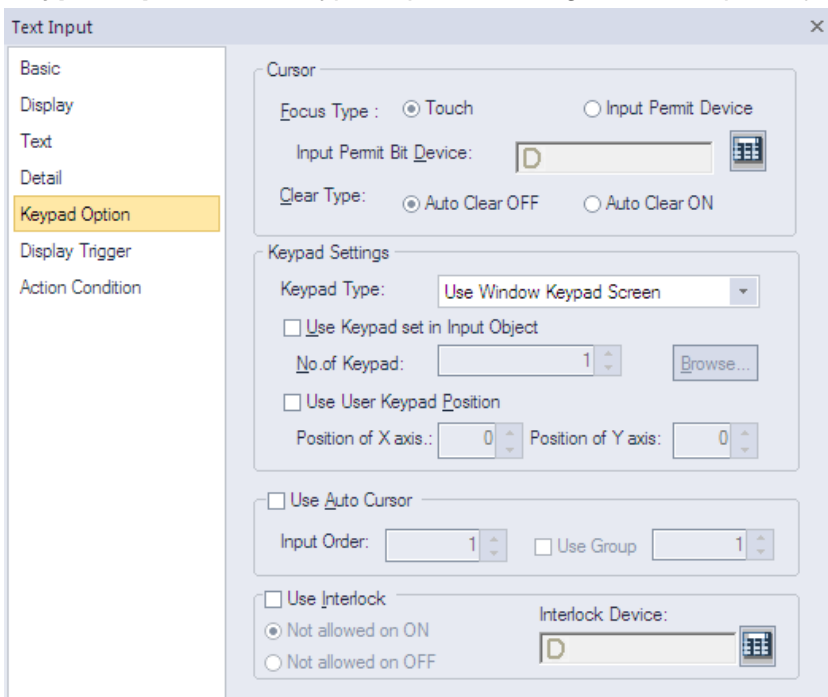

- **Cursor:** Set the movement type for using the automatic cursor.

<About cursor movement>

If the focus type is set to **Touch**, input objects for continuous inputs can be grouped together. Continuous inputs are performed in each group.

If there is an interlocked object with an input order, the input cursor will skip the locked unit and move automatically to the next unit in the sequence.

If you press a cursor moving special switch while on input, current input will be canceled and the data will return to the status before input. And the previous or next input object will be ready for input.

Focus Type

Set a method for moving the cursor. If you select **Touch**, the user must touch the input field to move the cursor. The flow for the **Touch** method is as follows:

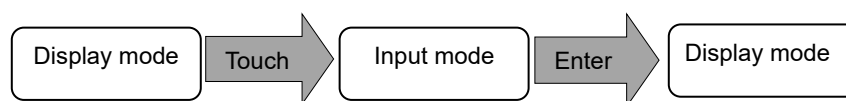

If you select **Input Permit Device**, the cursor moves only when the **Input Permit Bit Device** is on.

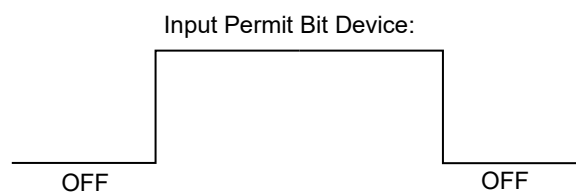

Input Permit Bit Device

Set the input permit bit device when Input Permit Device is selected.

Clear Type	Set whether or not to clear input data automatically when switching to input mode. <ul style="list-style-type: none"> • Auto Clear OFF: Shows the previous data in input mode. • Auto Clear On: Clears input data automatically when switching to input mode.
-------------------	---

- **Keypad Settings:** Set the key window options for data input. If you don't use the key window, you can also set the key switches using the special switch object.

Keypad Type	Set whether or not to use the Window Keypad Screen.
Use Keypad set in Input Object	Set whether or not to use the keypad specified in the key window settings. Enter the number of the key window or click [Browse] to locate the key window.
Use User Keypad Position	Set whether or not to specify a location for the key window. Set the coordinates for the X and Y axes. If you do not specify the location, the key window will appear at the upper left or upper right of the screen.

- **Use Auto Cursor:** Set whether or not to use the auto cursor function. When the user touches [Enter] while entering data in a key window, the cursor moves to the next input field automatically.

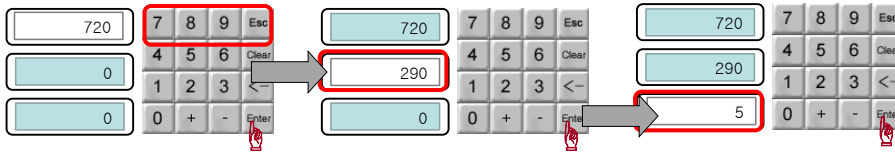

Input Order	Specify the sequence number of the window to control cursor movement.
Use Group	Specify the same sequence number of a group of windows to control cursor movement.

- **Use Interlock:** Set to prevent input when the interlock device meets the specified condition (device ON or OFF). The input cursor will skip the locked unit and move automatically to the next unit in the sequence.

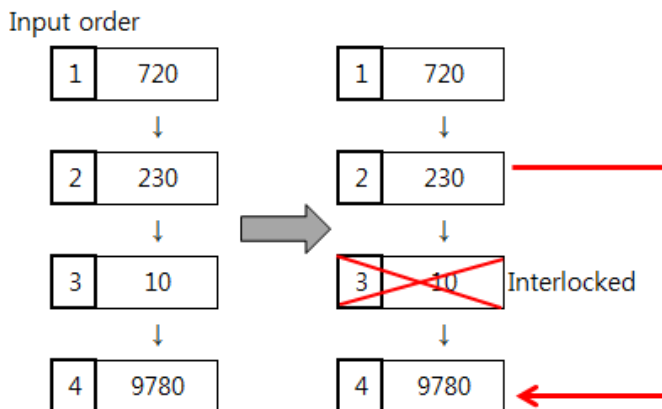

- **Display Trigger:** The display trigger settings for text input objects include the following.

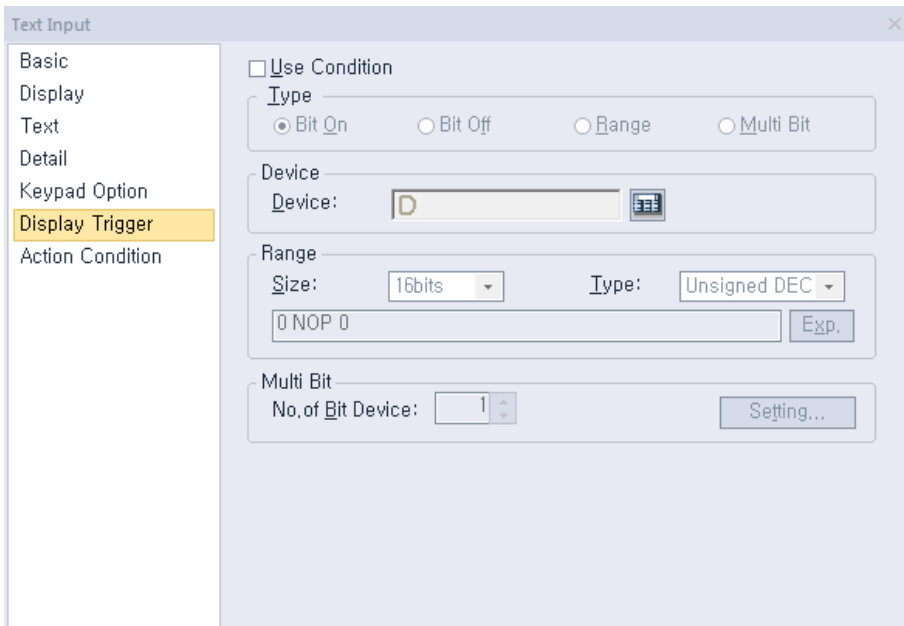

- **Use Condition:** Set whether or not to specify a condition for the action.
- **Type:** Set a type of condition to specify.

Bit On	The action is performed when the device is switched on.
Bit Off	The action is performed when the device is switched off.
Range	The action is performed when the value falls within the specified range.
Multi Bit	The action is performed when the logical operation result of multiple devices is met.

- **Device:** Enter a device or tag address directly into the input field or click the keypad icon to the right to specify a device or tag address. When you click the keypad icon to open the Device window, you can also specify network settings, if necessary.
- **Range:** If you select the range condition, specify the range.

Size	16 bit or 32 bit.
Type	Signed decimal, unsigned decimal, BCD, or float.
Exp.	Click to designate the expression as conditional.

- **Multi Bit:** If you select the multi bit condition, specify the number of bits and click [Setting] to specify the bit conditions.

- **Action Condition:** The action condition settings for text input objects include the following.

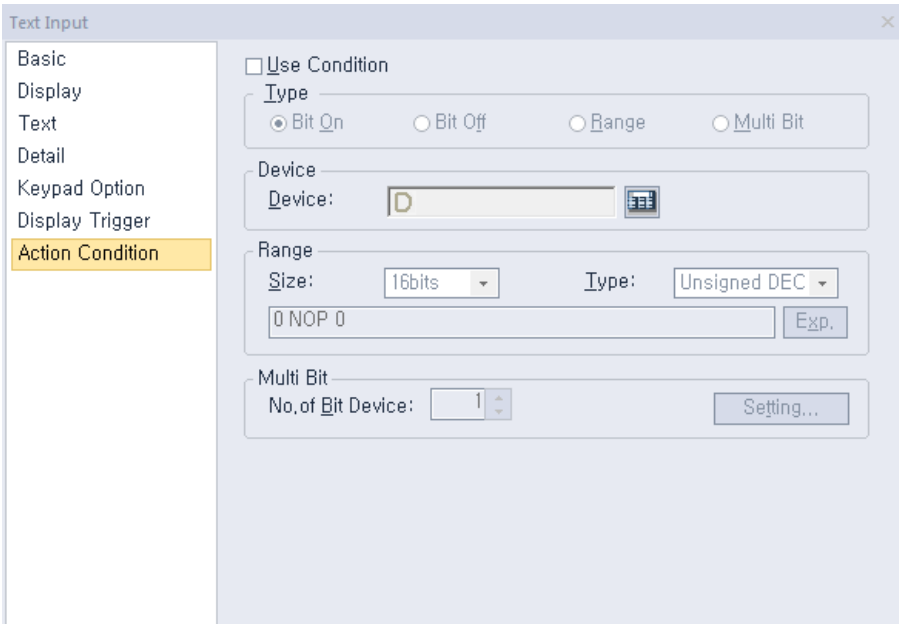

- **Use Condition:** Set whether or not to specify a condition for the action.
- **Type:** Set a type of condition to specify.

Bit On	The action is performed when the device is switched on.
Bit Off	The action is performed when the device is switched off.
Range	The action is performed when the value falls within the specified range.
Multi Bit	The action is performed when the logical operation result of multiple devices is met.

- **Device:** Enter a device or tag address directly into the input field or click the keypad icon to the right to specify a device or tag address. When you click the keypad icon to open the Device window, you can also specify network settings, if necessary.
- **Range:** If you select the range condition, specify the range.

Size	16 bit or 32 bit.
Type	Signed decimal, unsigned decimal, BCD, or float.
Exp.	Click to designate the expression as conditional.

- **Multi Bit:** If you select the multi bit condition, specify the number of bits and click [Setting] to specify the bit conditions.

4.3.4.4 Text Display

You can display text from a word device that is saved in ASCII code. For example, you can display four letters with the M00 device as the reference device, as shown here:

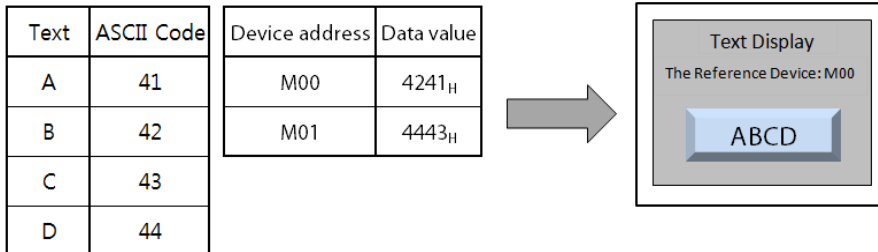

The data is read by word unit, with the low byte of the device value read first and the high byte read next:

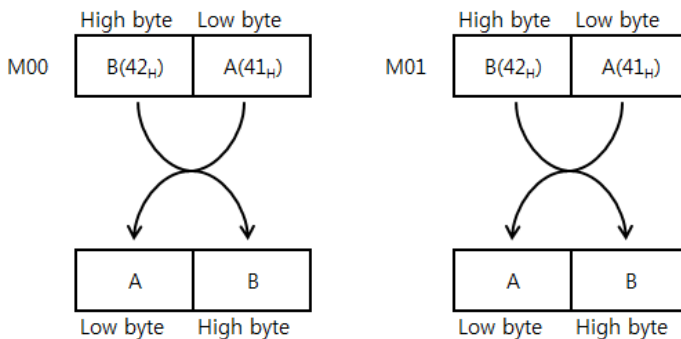

When you input the four-letter ASCII code, the value is displayed in the four bytes of the reading range from the device address.

This section describes available settings for text display objects.

- **Basic:** The basic settings for text display objects include the following.

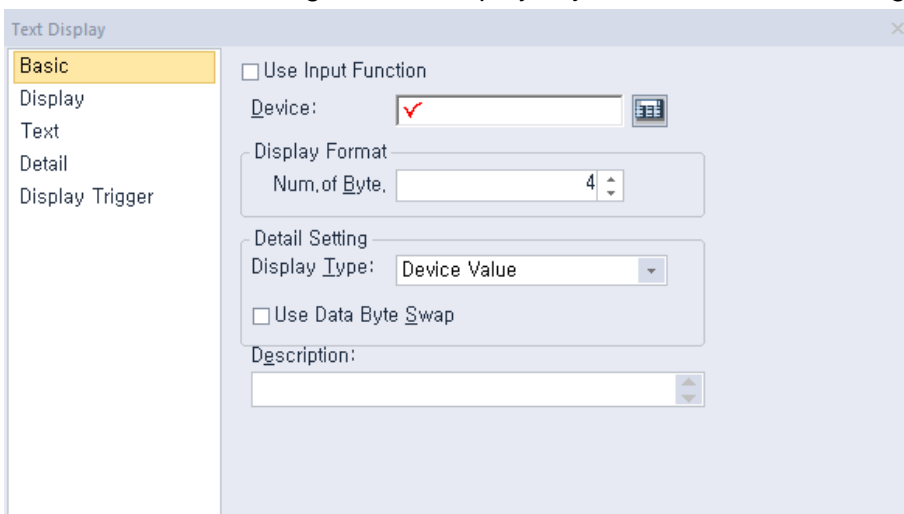

- **Use Input Function:** Check this option to change the text display object to a text input object. Object property setting options automatically change to fit the object type. Refer to <4.3.4.3 Text Input > for detailed information.

- **Device:** Enter a device or tag address directly into the input field or click the keypad icon to the right to specify a device or tag address. When you click the keypad icon to open the Device window you can also specify network settings, if necessary.
- **Display Format:** Set the display format.

Num. of Byte	Set the byte number of characters to display (2 to 64).
---------------------	---

- **Use Data Byte Swap:** Set to change output data into word form.
- **Display Type:** Set the display type.

Device Value	Use the value from the device address set in the Basic settings.
---------------------	--

Input Value	Display the value entered with the keypad on the current screen. If you set this option, you cannot use the Device , Display Format , and Use Data Byte Swap options.
--------------------	--

Input Max. Value	Display the maximum value in the text display according to the data type of the numeric input object currently inputting a value. If you set this option, you cannot use the Device , Display Format , and Use Data Byte Swap options. If the scaling feature or input condition is set in the numeric input object where the current value is being input, the maximum value of the intersection range of the input range restricted by the two features is displayed.
-------------------------	---

Input Min. Value	Display the minimum value in the text display according to the data type of the numeric input object currently inputting a value. If you set this option, you cannot use the Device , Display Format , and Use Data Byte Swap options. The range of the maximum and minimum input values differ by device size and the shape of the object generated by the pop-up keypad. Furthermore, if the input condition is set, the maximum and minimum values also differ, depending on the ranges of the input condition. If the scaling feature or input condition is set in the numeric input object where the current value is being input, the minimum value of the intersection range of the input range restricted by the two features is displayed.
-------------------------	--

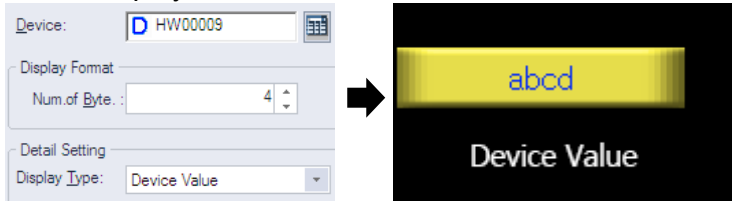
Bit Device Address	<p>Display the device address no the device value. If the settings are as follows, the value saved in the HW9 device will be displayed.</p>  <p>If Bit Device Address is selected, the address of the device is displayed as follows.</p>
---------------------------	---

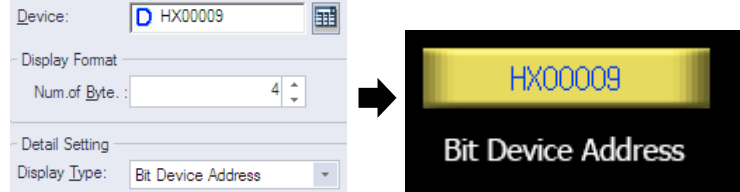
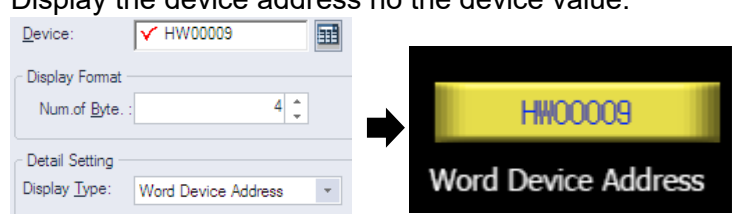
	 <p>XP30-BTE, XP30-TTE, XP40-TTE, XP50-TTE is not supported.</p>
<p>Word Device Address</p>	<p>Display the device address no the device value.</p>  <p>If you select Internal Device Skip on Device Address show in [COMMON] ▶ [Project Property Setting] ▶ [Language], an internal device address will not be displayed in a text display object in that Bit Device Address or Word Device Address is selected.</p> <p><input type="checkbox"/> Resize font when it use Text Table if the width of rectangle is greater than the text width <input checked="" type="checkbox"/> Internal Device Skip on Device Address show</p> <p>XP30-BTE, XP30-TTE, XP40-TTE, XP50-TTE is not supported.</p>

- **Description:** Enter a description for the object.

Note

- Spaces are counted in the number of bytes allowed for text input.
- 16 bit word devices allow entry of double-byte characters.
- The starting address of the specified reference device is the memory location for text input. The amount of text that can be input is the same as the volume of the memory location.

- **Display:** The display settings for text display objects include the following.

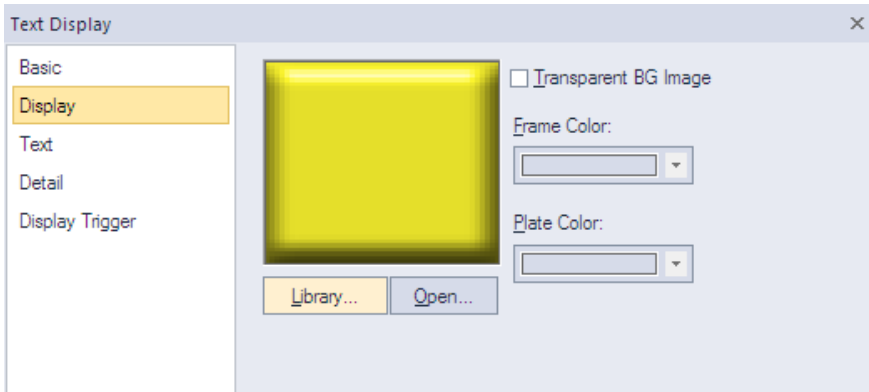

- **Library:** Click to select an image from the library.
- **Open:** Click to browse for images on your computer. When you select an image from your computer, it will be added to the image library automatically.
- **Transparent BG Image:** Click the checkbox to make the image background transparent. You cannot use a transparent background and the reverse image setting at the same time.

Frame Color	Set a frame color (only available with vector images).
Plate Color	Set a plate color (only available with vector images).

- **Text:** The text settings for text display objects include the following.

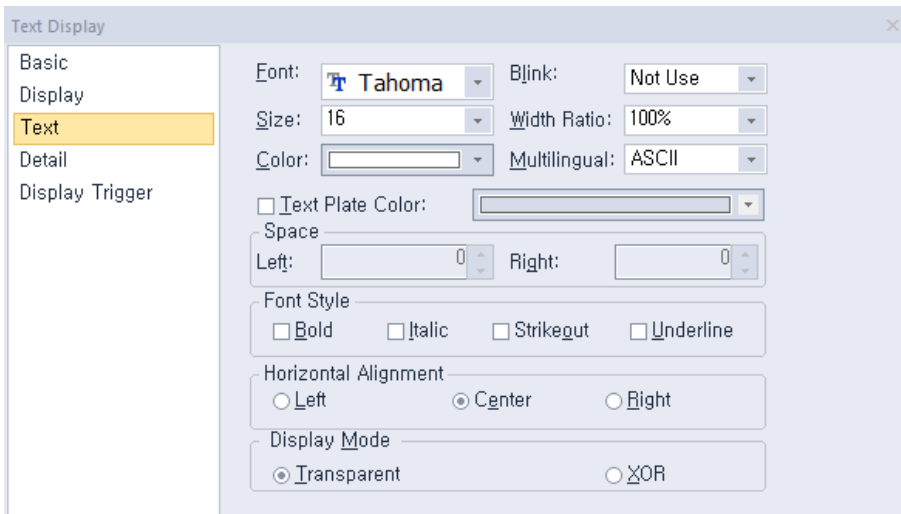

- **Font:** Select a font from the drop-down list.
- **Size:** Set a text size from the drop-down list or enter a value directly into the field.
- **Color:** Set a font color.
- **Blink:** Set a blink speed for the object:

Not use	The object will not blink.
Slow	The object will blink every three seconds.
Normal	The object will blink every two seconds.
Fast	The object will blink every second.

- **Width Ratio:** Expand or condense the text by selecting a ratio from the drop-down list or entering a value directly in to the field. You can set a rate of 1%-600%.
- **Multilingual:** Set an option for a second language (ASCII). If you select a language other than English, you cannot change the font. Fonts for other languages are displayed as set in the Language option of the Project Property settings. Refer to **<2.2.2.6 Changing Languages>** for more information.
- **Text Plate Color:** Click to set the background color of the figures at XGT Panel.
- **Space:** Set the indent from the margin of the object. If you select left alignment, you can set the left indent. If you select right alignment, you can set the right indent.
- **Font Style:** Set a font style (bold, italic, strikethrough, or underline). You can apply more than one option at a time.
- **Horizontal Alignment:** Set the horizontal alignment (Left, Center, or Right).
- **Display Mode:** Set an option for the color of the message based on the background color.

Transparent	Display the message transparently, in contrast to the background image.
XOR	Display the message in a color that is easily distinguished from the background image.

- **Detail:** The detail settings for text display objects include the following.

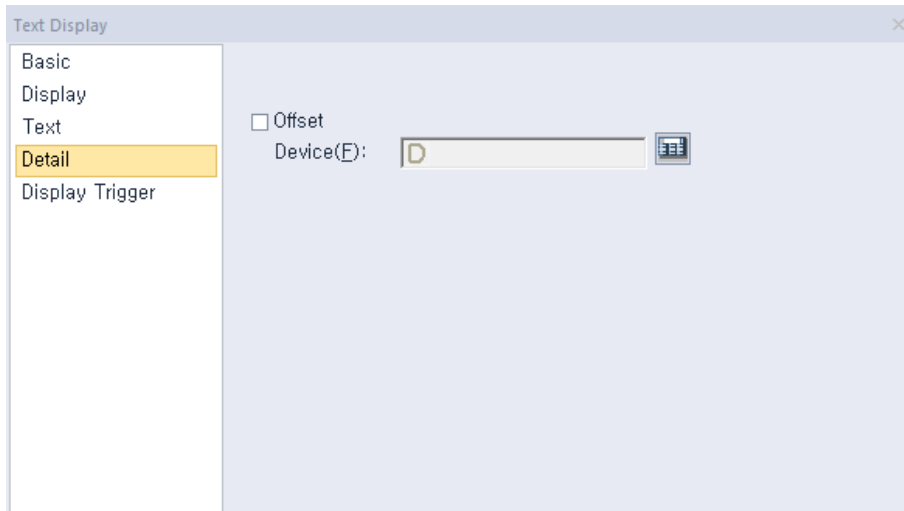

- **Offset:** Click the checkbox to use the offset function. You can offset the device address based on the value of the offset device. For example, if the starting device address is P100, XP-Builder reads the value from the offset device and offsets the address by that value. If the offset value is 10, for example, then the referenced device address is P110.
 - **Device:** Enter a device or tag address directly into the input field or click the keypad icon to the right to specify a device or tag address. When you click the keypad icon to open the Device window you can also specify network settings, if necessary.
- **Display Trigger:** The display trigger settings for text display objects include the following.

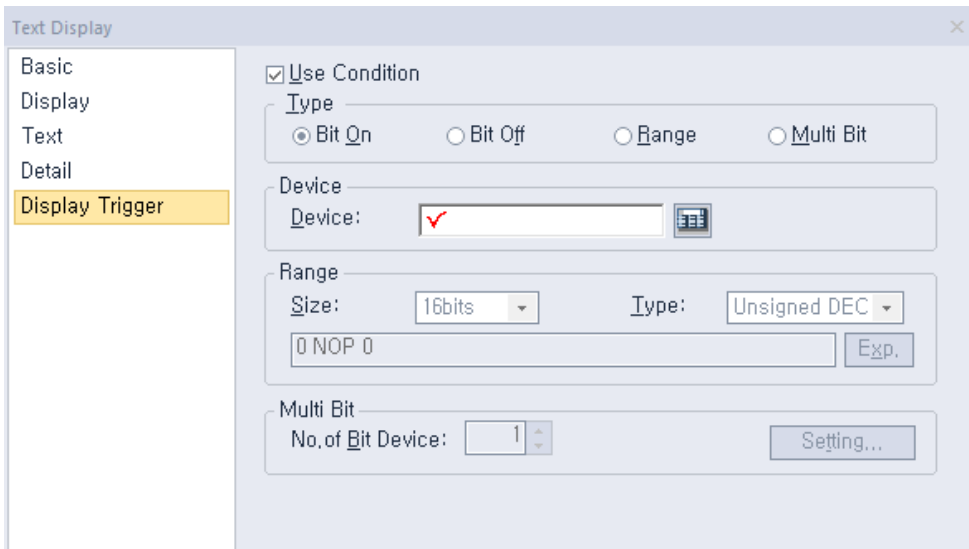

- **Use Condition:** Set whether or not to specify a condition for the action.
- **Type:** Set a type of condition to specify.

Bit On	The action is performed when the device is switched on.
Bit Off	The action is performed when the device is switched off.
Range	The action is performed when the value falls within the specified range.
Multi Bit	The action is performed when the logical operation result of multiple devices is met.

- **Device:** Enter a device or tag address directly into the input field or click the keypad icon to the right to specify a device or tag address. When you click the keypad icon to open the Device window, you can also specify network settings, if necessary.
- **Range:** If you select the range condition, specify the range.

Size	16 bit or 32 bit.
Type	Signed decimal, unsigned decimal, BCD, or float.
Exp.	Click to designate the expression as conditional.

- **Multi Bit:** If you select the multi bit condition, specify the number of bits and click [Setting] to specify the bit conditions.

4.3.5 Window Objects

Window objects allow you to invoke windows based on the conditions of the device.

4.3.5.1 Bit Window

This section describes available settings for bit window objects.

- **Basic:** The basic settings for bit window objects include the following.

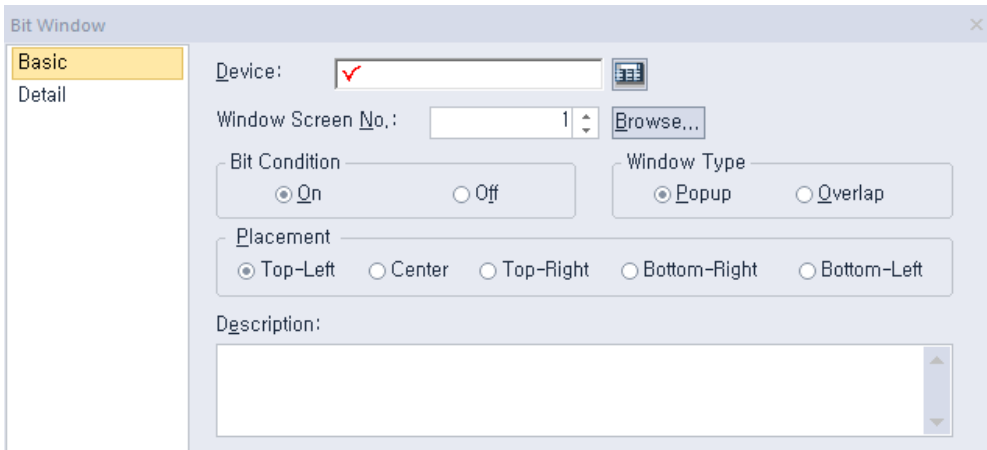

- **Device:** Enter a device or tag address directly into the input field or click the keypad icon to the right to specify a device or tag address. When you click the keypad icon to open the Device window you can also specify network settings, if necessary.
- **Window Screen No.:** Set the window number to invoke or click [Browse] to locate the window.
- **Bit Condition:** Set the bit condition for invoking the window (on or off).
- **Window Type:** Set the type of window to invoke.

Popup	Set to open a new window on top of the existing window.
Overlap	Set to overlay a new window in an area where no figures or objects exist on the Base screen, so that the Base screen can still be seen.

- **Placement:** Set the location where the new window will appear on the screen (top-left, center, top-right, bottom-right, or bottom-left). For example, if you set the location to “Top-Left”, the window will appear aligned to the upper-left corner of the object.

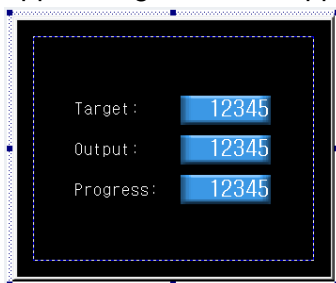

<Window>

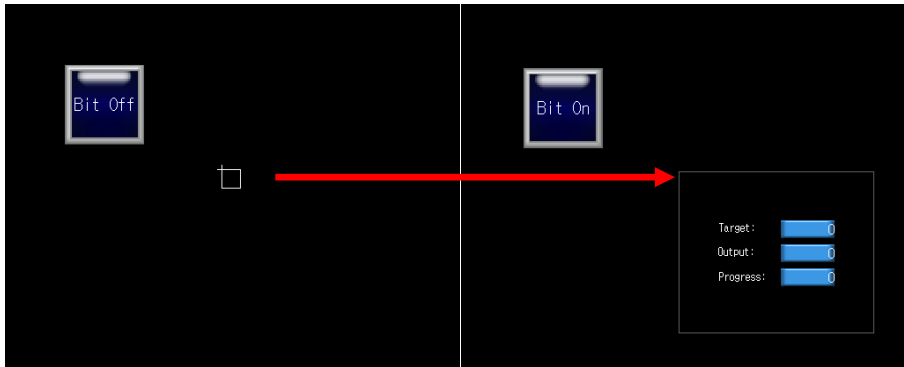

<Example of a "Top-Left" placement>

Below are the descriptions for the placement options.

Placement	Description
Top-Left	Align the upper left corners of the window and the object.
Center	Align the centers of the window and the object.
Top-Right	Align the upper right corners of the window and the object.
Bottom-Right	Align the lower right corners of the window and the object.
Bottom-Left	Align the lower left corners of the window and the object.

Note

- If the input window area exceeds the borders of the Base screen, it is not displayed in the XGT Panel. In this case, the project download will not start. If the window object area partially extends beyond the right or bottom of the Base screen, only the portion of the object that is inside the borders will be displayed.

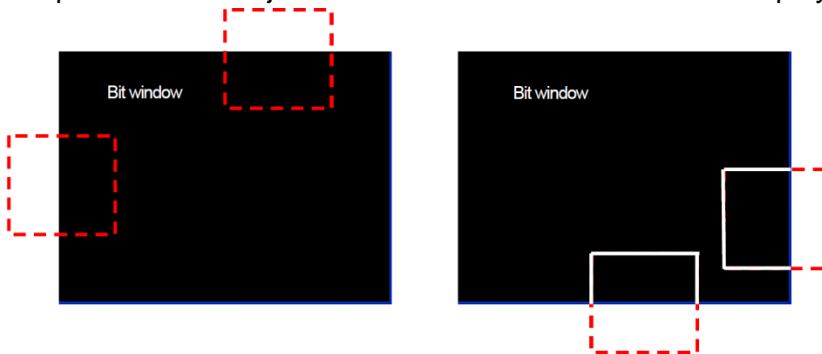

- There are two ways to close the bit window when the condition is met.
 1. Reverse the reference device status.
 2. For a pop-up window, click the close button. The device status is converted automatically. If the windows overlap, the close button is not displayed.
- The placement points for Window and Part objects are listed in the table below.

Object	Placement Point
Window Object	The start point of the edited Window screen
Part Object	The start point where the parts are drawn in the edited Part screen.

- **Description:** Enter a description of the object.

- **Detail:** The detail settings for bit window objects are shown in the screenshot below.

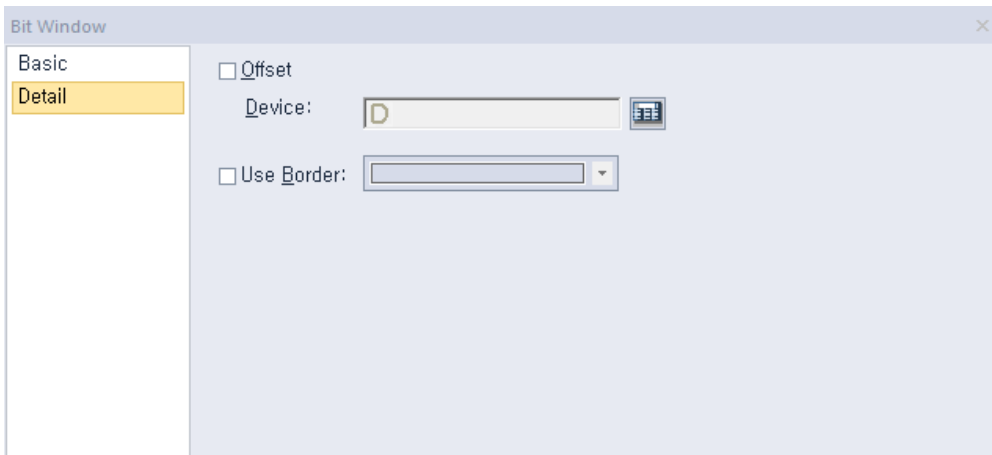

- **Offset:** Check the checkbox to use the Offset function. You can offset the device address based on the value of the offset device. For example, if the starting device address is P100, XP-Builder reads the value from the offset device and offsets the address by that value. If the offset value is 10, for example, then the referenced device address is P110.
- **Device:** Enter a device or tag address directly into the input field or click the keypad icon to the right to specify a device or tag address. When you click the keypad icon to open the Device window you can also specify network settings, if necessary.
- **Use Border:** Set the border color of a window object in XP-Builder. If the border color is not set, a window object will be displayed in the color you set in [TOOL] ► [Option] ► [Edit Option] ► [Default Line Color of Figure/Object].

The border is not displayed on the XGT Panel screen. It is displayed only in XP builder.



4.3.5.2 Word Window

This section describes available settings for word window objects.

- **Basic:** The basic settings for word window objects are shown in the screenshot below.

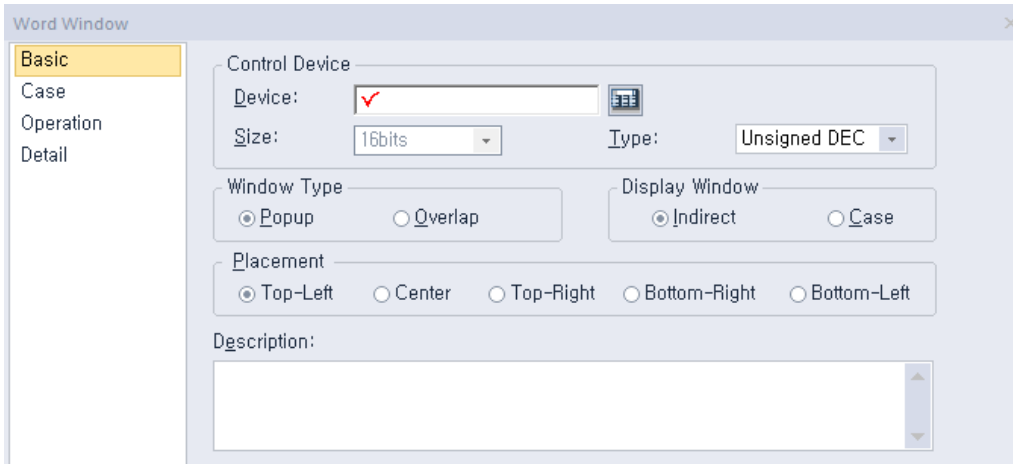

– **Control Device:**

Device	Enter a device or tag address directly into the input field or click the keypad icon to the right to specify a device or tag address. When you click the keypad icon to open the Device window you can also specify network settings, if necessary.
Size	Set the data size for the object (16 or 32 bit). If Display Part Screen is set to “Indirect”, the size is fixed to 16 bit and cannot be changed.
Type	Set the data type for the object (signed decimal, Unsigned decimal, or BCD).

– **Window Type:** Set the type of window to invoke.

Popup	Set to open a new window on top of the existing window.
Overlap	Set to overlay a new window in an area where no figures or objects exist on the Base screen, so that the Base screen can still be seen.

– **Display Window:** Set the method for invoking the window.

Indirect	Invoke the window based on the device value.
Case	Invoke the window when the condition is met. Conditional expressions can be created only when Case is selected.

- **Placement:** Set the location where the new window will appear on the screen (top-left, center, top-right, bottom-right, or bottom-left). For example, if you set the location to “Top-Left”, the window will appear aligned to the upper-left corner of the object.

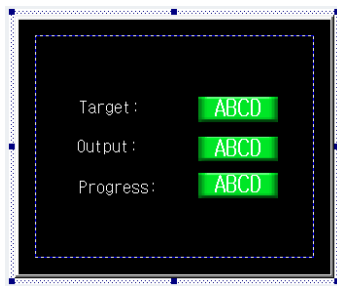

<Window>

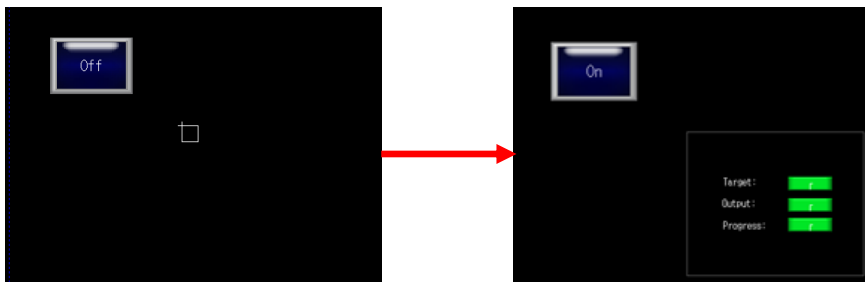

<Example of a "Top-Left" placement>

Below are the descriptions for the placement options.

Placement	Description
Top-Left	Align the upper left corners of the window and the object.
Center	Align the centers of the window and the object.
Top-Right	Align the upper right corners of the window and the object.
Bottom-Right	Align the lower right corners of the window and the object.
Bottom-Left	Align the lower left corners of the window and the object.

Note

- If the data size or type are changed, the input and display condition are deleted.
- If the Display Window setting changes to Indirect, the input and display condition are deleted.
- If the input window area exceeds the borders of the Base screen, it is not displayed in the XGT Panel. In this case, the project download will not start. If the window object area partially extends beyond the right or bottom of the Base screen, the portion of the object that is inside the borders will be displayed.

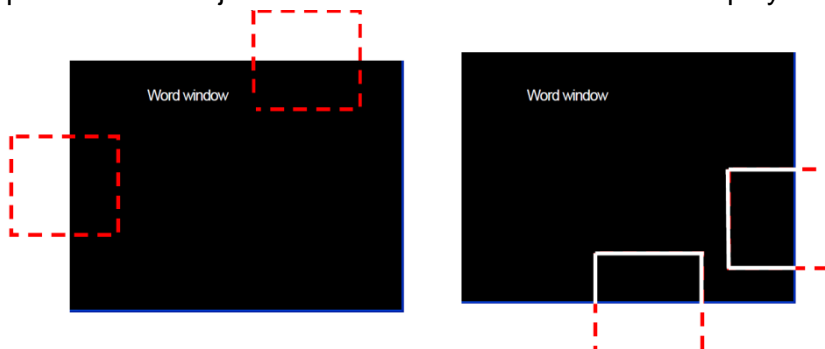

- The Word Window object is always displayed on the basic screen and you cannot

close the window, as there is no close button. The Word Window object can be allocated two or more states, so it cannot be determined how the reference device state should change even if the present Window screen is closed.

- The placement points for the Window and Part objects are listed in the table below.

Object	Placement Point
Window Object	The start point of the edited Window screen.
Part Object	The start point where the parts are drawn in the edited Part screen.

- **Description:** Enter a description for the object.

- **Case:** The case settings for word window objects are shown in the screenshot below.

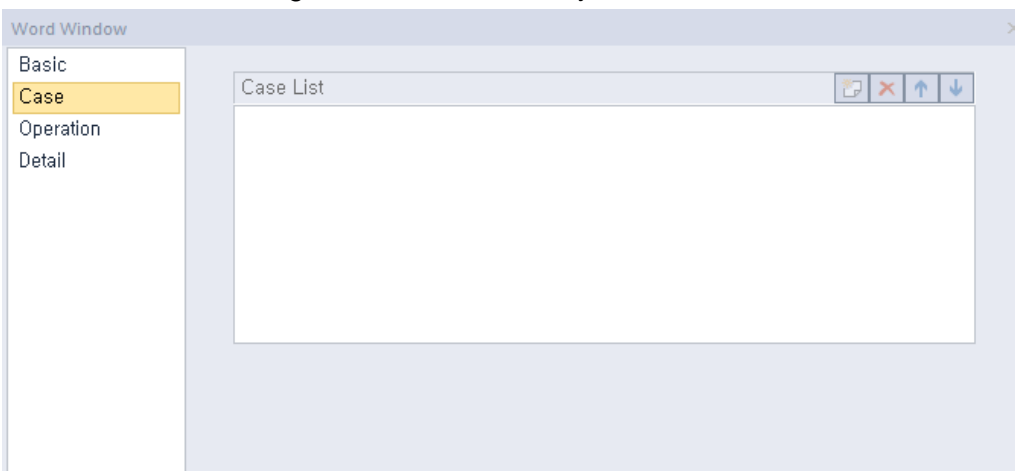

- **Case List:** Create, delete, or reorganize conditional expressions:

	(Create)	Click to create a new range condition. You can create up to eight conditions. Clicking this icon opens the Range Edit window, which allows you to create a condition. For more information, refer to <4.2.1.3 Understanding Constants and Data Types> .
	(Delete)	Click a condition and then click this icon to delete the condition.
	(Up)	Click a condition and then click this icon to move it higher up the list.
	(Down)	Click a condition and then click this icon to move it lower down the list.

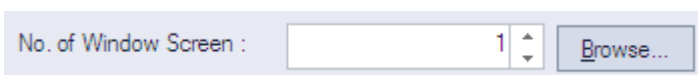

A number can be set for a window screen that pops up or overlaps when a condition is met. You can directly set the number or browser for a window screen. If you click the Browser button, all the window screens created will be displayed in thumbnails as shown below. Select a window screen to set the number.

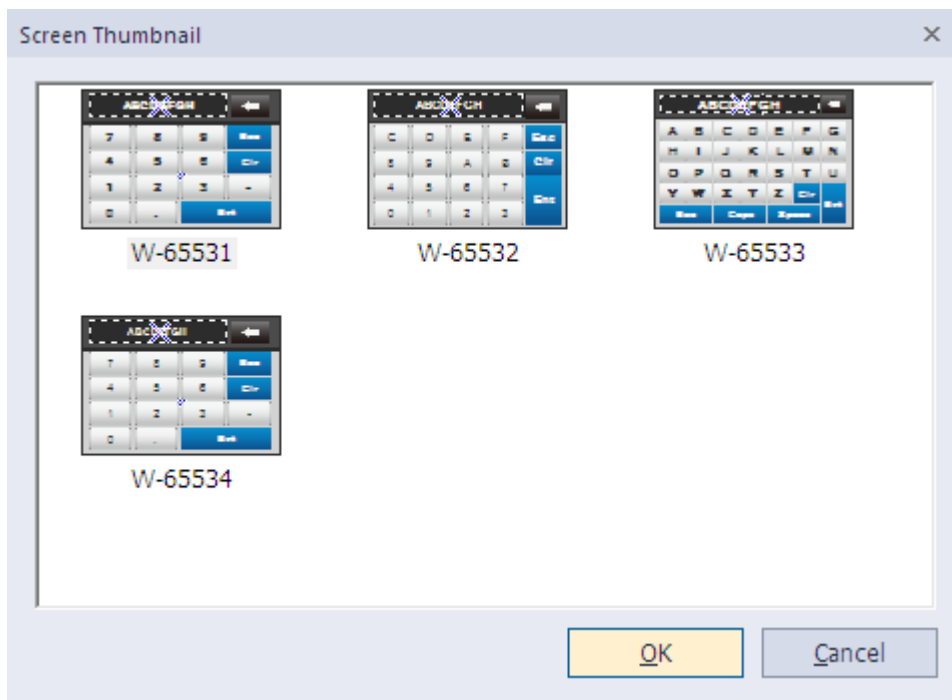

- **Operation:** The operation settings for word window objects are shown in the screenshot below.

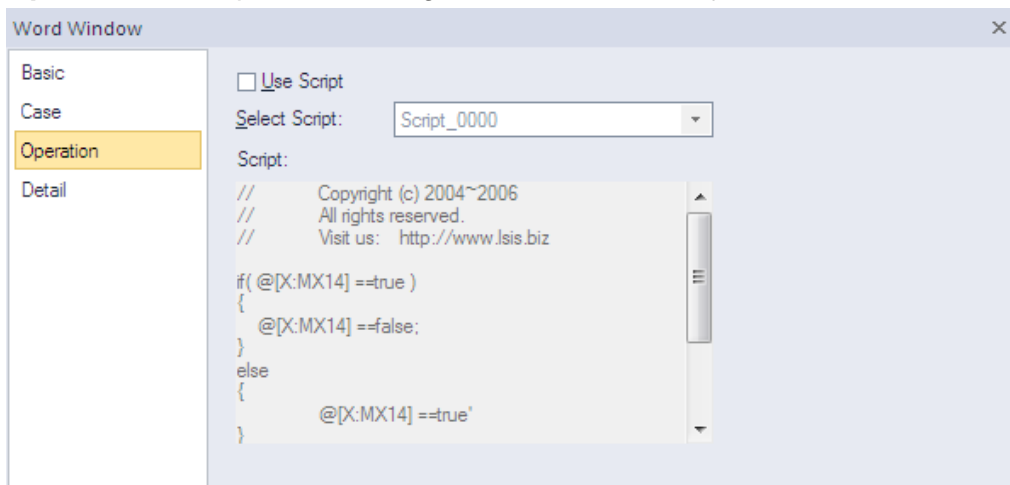

- **Use Script:** Check the checkbox to use a script with the object.
- **Select Script:** Select a script from the drop-down list.
- **Script:** When you select a script, it appears here. To modify a script, refer to <4.2 >

- **Detail:** The detail settings for word window objects are shown in the screenshot below.

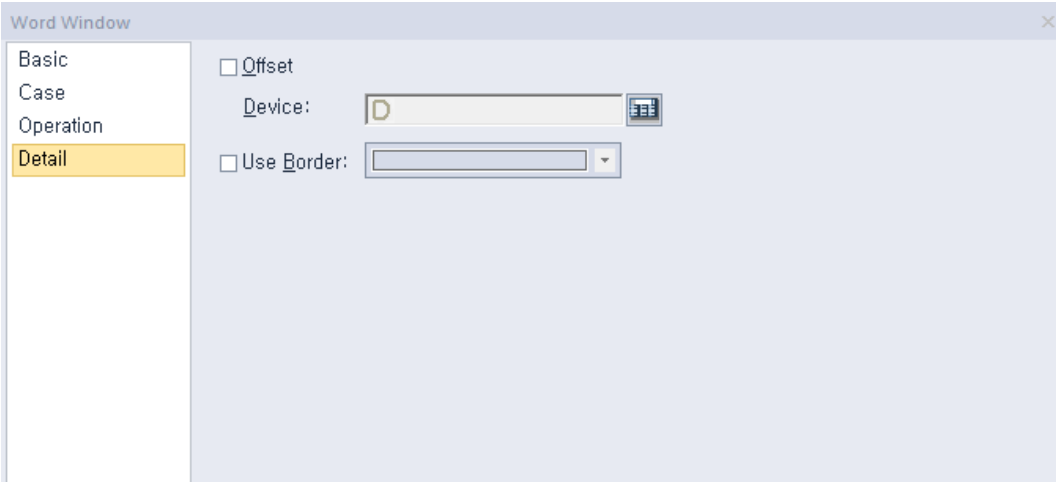

- **Offset:** Check the checkbox to use the offset function. You can offset the device address based on the value of the offset device. For example, if the starting device address is P100, XP-Builder reads the value from the offset device and offsets the address by that value. If the offset value is 10, for example, then the referenced device address is P110.
The Offset function behaves differently if a read device is set. When a read device is set, the offset is only applied to the writing device. If a read device is not set, the offset is applied to both read and write devices.
- **Device:** Enter a device or tag address directly into the input field or click the keypad icon to the right to specify a device or tag address. When you click the keypad icon to open the Device window you can also specify network settings, if necessary.
- **Use Border:** Set the border color of a window object on XP-Builder. If the border color is not set, a window object will be displayed in the color you set in [TOOL] ► [Option] ► [Edit Option] ► [Default Line Color of Figure/Object]. This function is only for the XGT Panel and does not affect editing.

<Examples>



4.3.6 Part Objects

You can use part objects to invoke parts based on the device condition. There are four movement types of the part objects: Fixed, XY, Line, and Route.

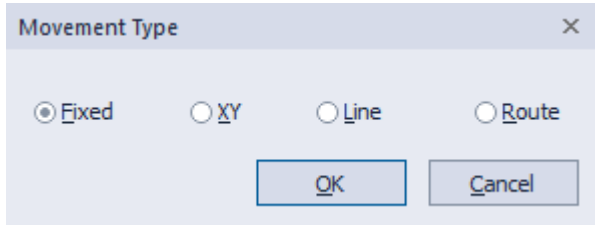

- **Fixed:** Display the part according to the registered location condition in XP-Builder.
- **XY:** Display the part on the dot registered as the device value. The XY coordinates are set based on the device value regardless of the current XY coordinates of that object.

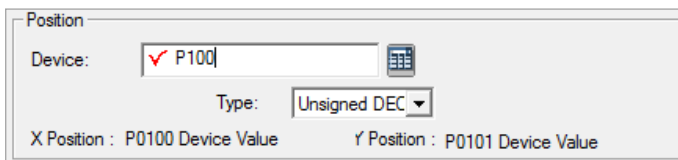

In this case, the X location value is the same as the device address (P100) and the Y location value is the device address plus 1 (P101). In the below example, the device value is shown in the table.

Device	(1)	(2)	(3)
X coordinate (P100)	20	130	180
Y coordinate (P101)	80	200	18

The bit object movement for the above example is shown below.

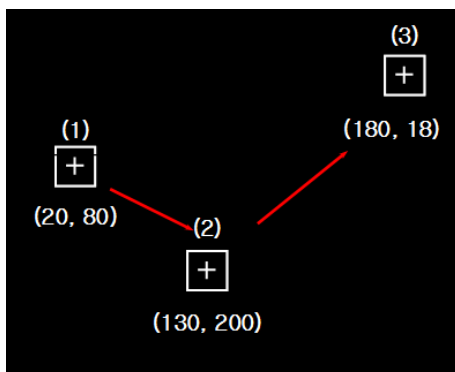

- **Line:** Display the movement of the object through the straight line. Set the minimum value as the starting point, and the maximum value as the ending point.

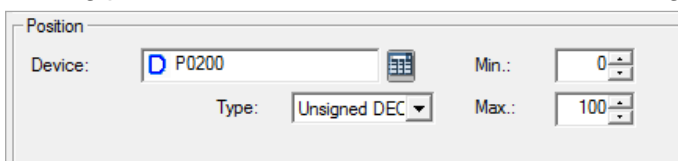

In this case, the X and Y location are relative based on the maximum and minimum value. The X location value is the same as the device address (P100) and the Y location value is the device address plus 1 (P101).

If the XY device value is as below:

Device	(1)	(2)	(3)
Device Value	0	50	100

Then the bit object movement is as below:

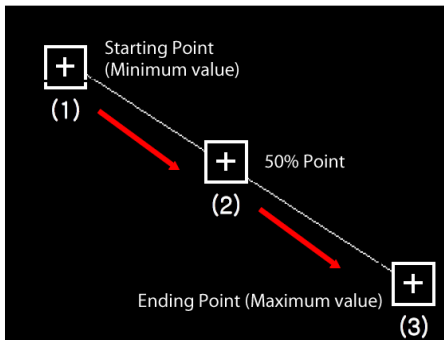

A starting point has a dot, whereas an ending point does not.

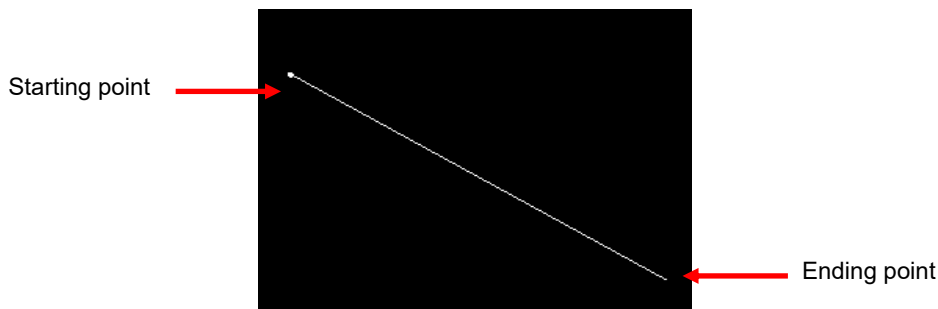

- **Route:** Display the movement of the object according to the point you set in advance. You can set the point to display the part.

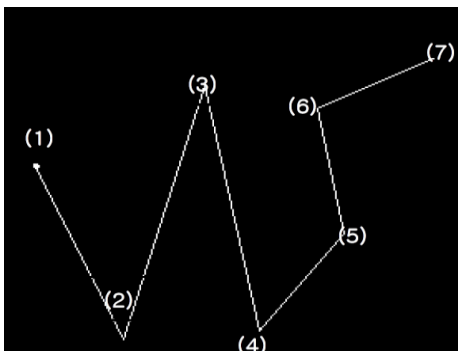

If the location device value is 6, the part moves along path (6). If the location device value is 1 and 4, it moves along paths (1) and (4) respectively.

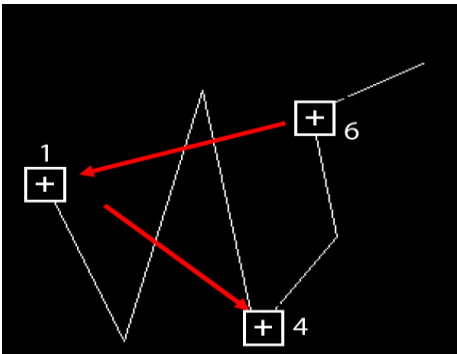

4.3.6.1 Bit Part

This section describes available settings for bit part objects.

- **Basic:** The basic settings for bit part objects are shown in the screenshot below.

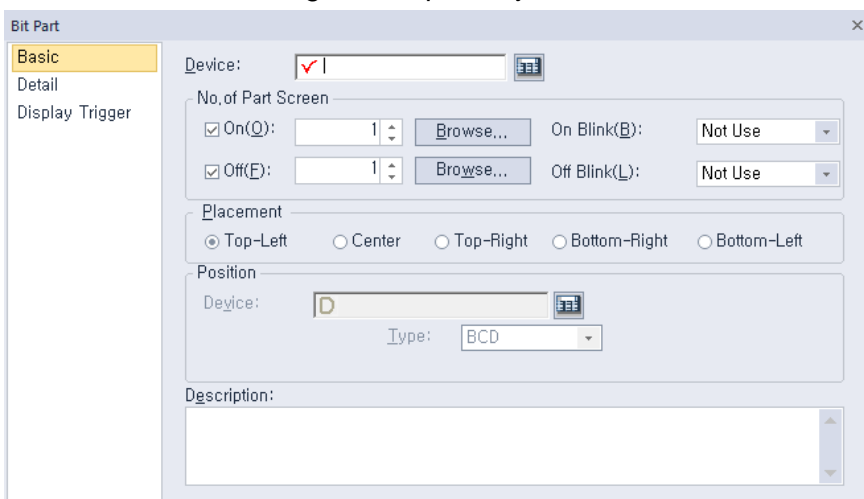

- **Device:** Enter a device or tag address directly into the input field or click the keypad icon to the right to specify a device or tag address. When you click the keypad icon to open the Device window you can also specify network settings, if necessary.
- **No. of Part Screen:** Set the parts to invoke.

On	Set the part to invoke when the device is set to “On”.
Off	Set the part to invoke when the device is set to “Off”.
On Blink	Set the part to blink when the device is set to “On” (not use, slow, normal, and fast).
Off Blink	Set the part to blink when the device is set to “Off” (not use, slow, normal, and fast).

- **Placement:** Set the location where the new part will appear on the screen (top-left, center, top-right, bottom-right, or bottom-left). For example, if you set the location to “Top-Left”, the part will appear in the upper-left corner of the object.

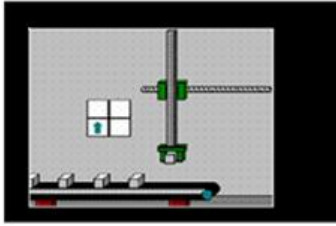

<Part>

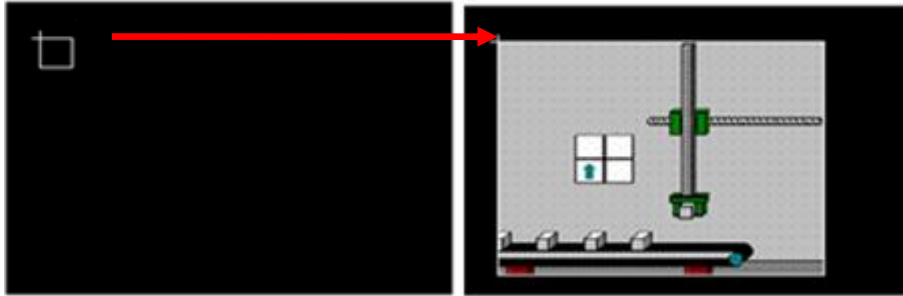

<Example of a "Top-Left" placement>

Type	Description
Top-Left	Align the upper-left corner of the part with the upper-left corner of the object.
Center	Center the part over the object.
Top-Right	Align the upper-right corner of the part with the upper-right corner of the object.
Bottom-Right	Align the lower-right corner of the part with the lower-right corner of the object.
Bottom-Left	Align the lower-left corner of the part with the lower-left corner of the object.

Note

- If an area of the part extends beyond the borders of the Base screen, only the area inside the window borders will be displayed.

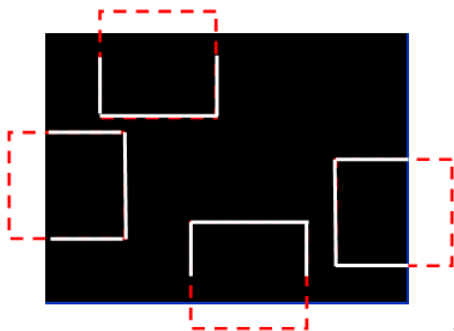

- The placement points for Window and Part objects are as follows:

Object	Placement Point
Window Object	The start point of the edited Window screen.
Part Object	The start point where the parts are drawn in the

edited Part screen.

- **Position:** Set a device to control values for the relative location of the part for XY, Line, and Route paths. The size of the path position device is fixed at 16 bit. The maximum and minimum values restrict the path of a part, based on the device value (only for line paths).
 - **Description:** Enter a description of the object.
- **Detail:** The detail settings for text bit part objects are shown in the below screenshot.

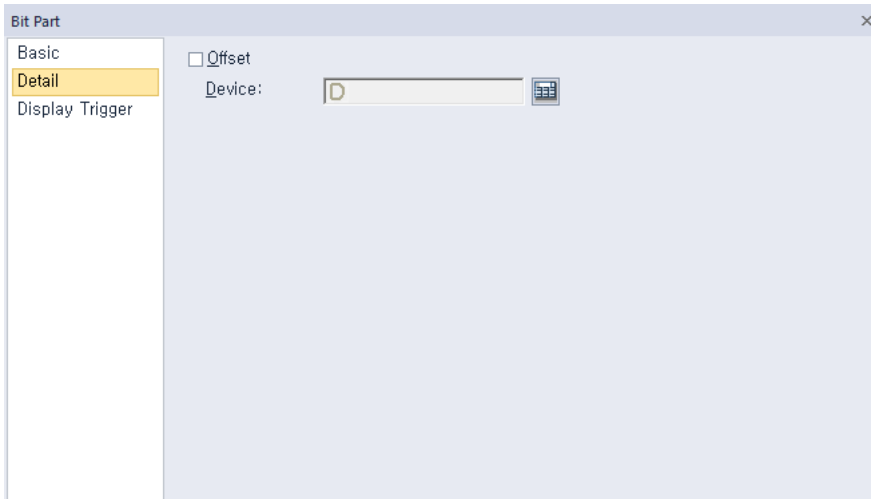

- **Offset:** Check the checkbox to use the Offset function. You can offset the device address based on the value of the offset device. For example, if the starting device address is P100, XP-Builder reads the value from the offset device and offsets the address by that value. If the offset value is 10, for example, then the referenced device address is P110.
- **Device:** Enter a device or tag address directly into the input field or click the keypad icon to the right to specify a device or tag address. When you click the keypad icon to open the Device window you can also specify network settings, if necessary.

- **Display Trigger:** The display trigger settings for bit part objects are shown in the below screenshot.

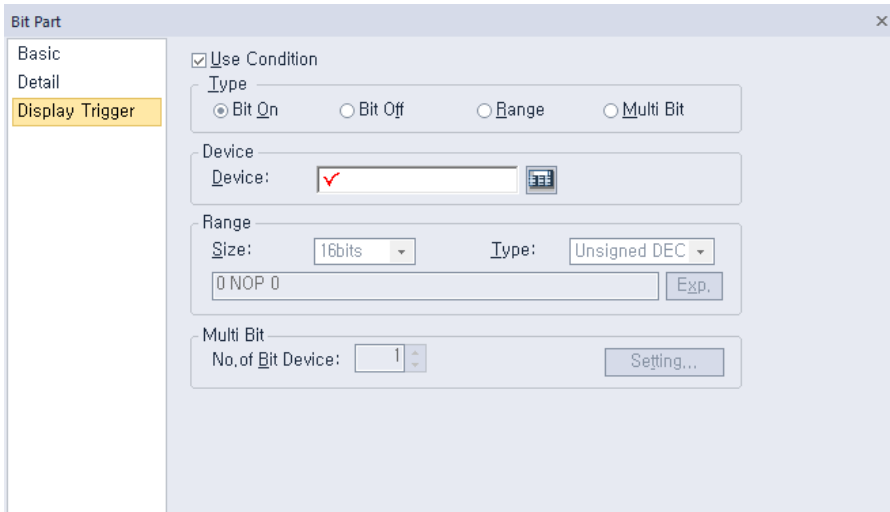

- **Use Condition:** Set whether or not to specify a condition for the action.
- **Type:** Set a type of condition to specify.

Bit On	The action is performed when the device is switched on.
Bit Off	The action is performed when the device is switched off.
Range	The action is performed when the value falls within the specified range.
Multi Bit	The action is performed when the logical operation result of multiple devices is met.

- **Device:** Enter a device or tag address directly into the input field or click the keypad icon to the right to specify a device or tag address. When you click the keypad icon to open the Device window, you can also specify network settings, if necessary.
- **Range:** If you select the range condition, specify the range.

Size	16 bit or 32 bit.
Type	Signed decimal, unsigned decimal, BCD, or float.
Exp.	Click to designate the expression as conditional.

- **Multi Bit:** If you select the multi bit condition, specify the number of bits and click [Setting] to specify the bit conditions.

4.3.6.2 Word Part

This section describes available settings for word part objects.

- **Basic:** The basic settings for word part objects are shown in the below screenshot.

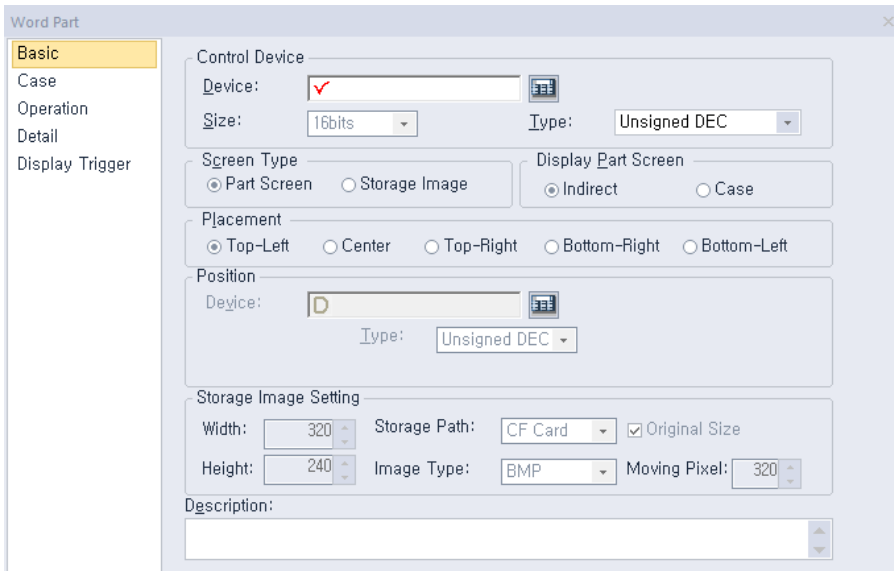

– **Control Device:**

Device	Enter a device or tag address directly into the input field or click the keypad icon to the right to specify a device or tag address. When you click the keypad icon to open the Device window you can also specify network settings, if necessary.
Size	Set the data size for the object (16 or 32 bit). If Display Part Screen is set to “Indirect”, the size is fixed to 16 bit and cannot be changed.
Type	Set the data type for the object (Signed decimal, unsigned decimal, BCD, or float).

– **Screen Type:** Set the type of part to invoke.

Part Screen	Set to invoke a part.
Storage Image	Set to invoke an image from a storage location, such as a CF card or USB device. Images can only be invoked from a folder titled “XP_User Image.” Image filenames must be formatted with the prefix, img, followed by a five digit number, for example, “ImgXXXXX.bmp” or “ImgXXXXX.jpg.” If the filename is such as “Img00000.bmp” or “img00000.jpg,” then the device value is “0,” and the image will not be invoked.

– **Display Part Screen:** Set the method for invoking the window.

Indirect	Invoke the window based on the device value. It is either the window number or the image file name that the device value invokes. For example, if the device value is “1” and the screen type is set to Part Screen, Part Screen 1 will be invoked. If the screen type is set to Storage Image, the file “img00001.bmp” will be invoked.
-----------------	--

Case Invoke the window when the condition is met.

- **Placement:** Set the location where the new part will appear on the screen (top-left, center, top-right, bottom-right, or bottom-left). For example, if you set the location to “Top-Left”, the part will appear in the upper-left corner of the object.

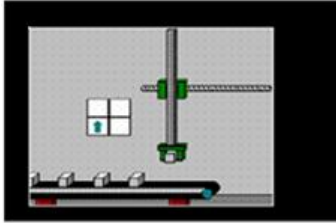

<Part>

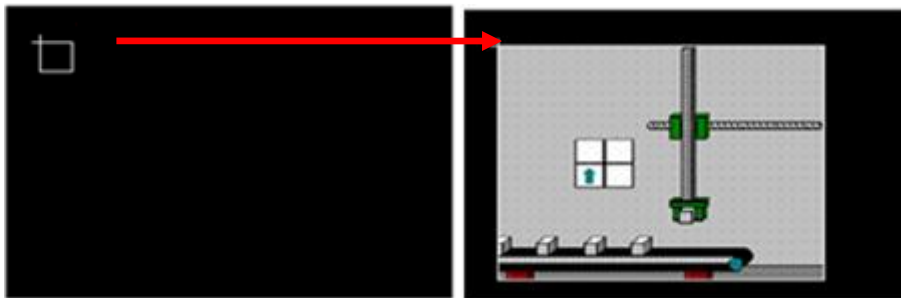

<Example of a “Top-Left” placement>

Type	Description
Top-Left	Align the upper-left corner of the part with the upper-left corner of the object.
Center	Center the part over the object.
Top-Right	Align the upper-right corner of the part with the upper-right corner of the object.
Bottom-Right	Align the lower-right corner of the part with the lower-right corner of the object.
Bottom-Left	Align the lower-left corner of the part with the lower-left corner of the object.

Note

- If the data size or type is changed, the input and display conditions are deleted.
- If the Display Part Screen setting changes to Indirect, the input and display conditions are deleted.
- If an area of the part extends beyond the borders of the Base screen, only the area inside the borders will be displayed.

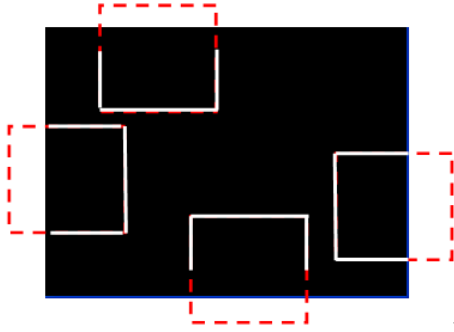



- The placement points for the Window and Part objects are as follows:

Object	Placement Point
Window Object	The start point of the edited Window screen.
Part Object	The start point where the parts are drawn in the edited Part screen.

- When the Screen Type setting is Storage Image and the Display Part Screen setting is Indirect, the image from the storage device that corresponds to the current control device is displayed.

- **Position:** Set a device to control values for the relative location of the part for XY, Line, and Route paths. The size of the path position device is fixed at 16 bit. The maximum and minimum values restrict the path of a part based on the device value (only for line paths).
- **Storage Image Setting:** Set options for using images from a storage location.

Width	Set the width of the image when you import an image from the storage device. The image size is reduced or expanded to fit the width you set. When you set the Original size option, you can view as much of the original image as fits within the width you set.
Height	Set the height of the image when you import an image from the storage device. The image size is reduced or expanded to fit the height you set. When you set the Original size option, you can view as much of the original image as fits within the height you set.
Storage Path	Select the storage location for the image.
Original size	Set to show the image in its original size. If the image size is larger than the Base screen, only as much of the image as fits within the Base screen will be displayed, as shown below.

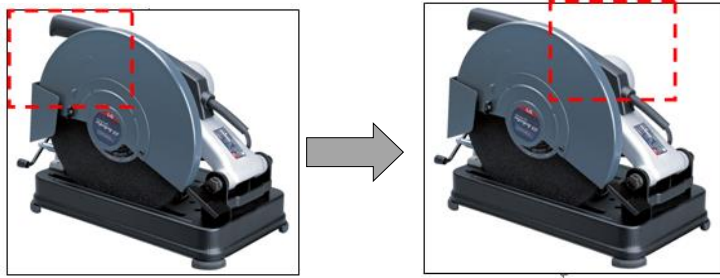

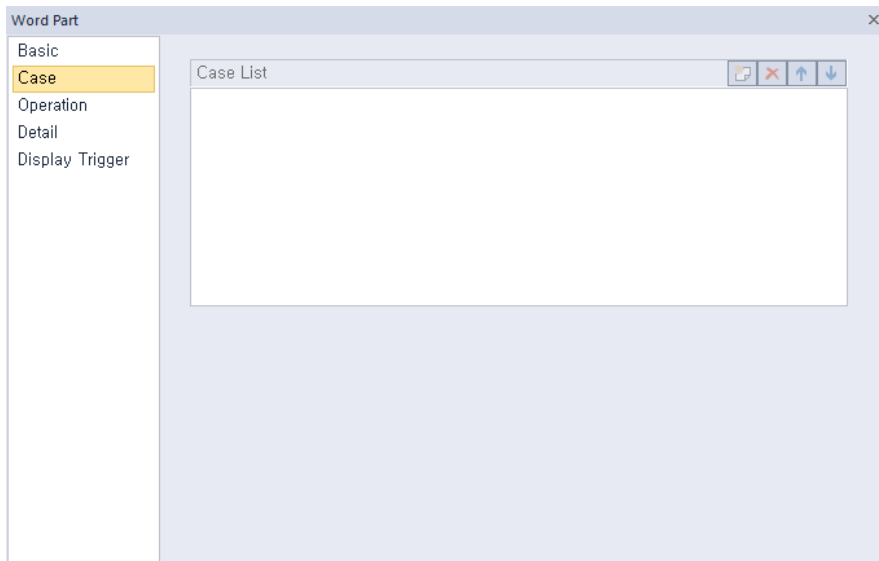

	<div style="display: flex; justify-content: space-around; align-items: center;"> <div style="text-align: center;">  <p><Original Image></p> </div> <div style="text-align: center;">  <p><Maintain the original size></p> </div> </div> <p>If you do not set this option, the image will be reduced to the width and height you set. When you set the width and height to 640x480, the image is shown as follows:</p> <div style="text-align: center;">  </div>
<p>Image Type</p>	<p>Select the image type (BMP or JPG).</p>
<p>Moving Pixel</p>	<p>When an image is too large to be shown on the screen in its entirety, set the number of pixels to scroll when the user scrolls up, down, left, or right to see another part of the image. Use this option when you set the Original Size option.</p> <div style="text-align: center;">  </div>

- **Description:** Enter a description of the object.

- **Case:** The case settings for word part objects are shown in the screenshot below.



- **Case List:** Create, delete, or reorganize conditional expressions:

 (Create)	Click to create a new range condition. You can create up to eight conditions. Clicking this icon opens the Range Edit window, which allows you to create a condition. For more information, refer to <4.2.1.3 Understanding Constants and Data Types> .
 (Delete)	Click a condition and then click this icon to delete the condition.
 (Up)	Click a condition and then click this icon to move it higher up the list.
 (Down)	Click a condition and then click this icon to move it lower down the list.



A number can be set for a part screen that pops up or overlaps when a condition is met. You can directly set the number or browser for a part screen. If you click the Browser button, all the part screens created will be displayed in thumbnails as shown below. Select a part screen to set the number.

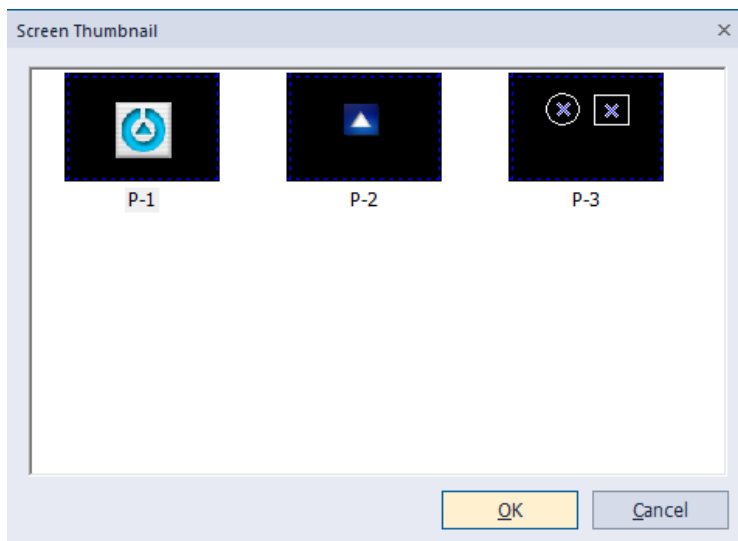

Note

Browser button is not provided if the Screen type is set to Storage Image in Basic property window.

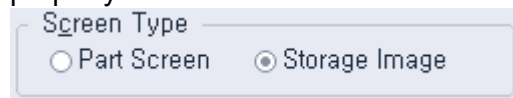

- **Operation:** The operation settings for word part objects are shown in the below screenshot.

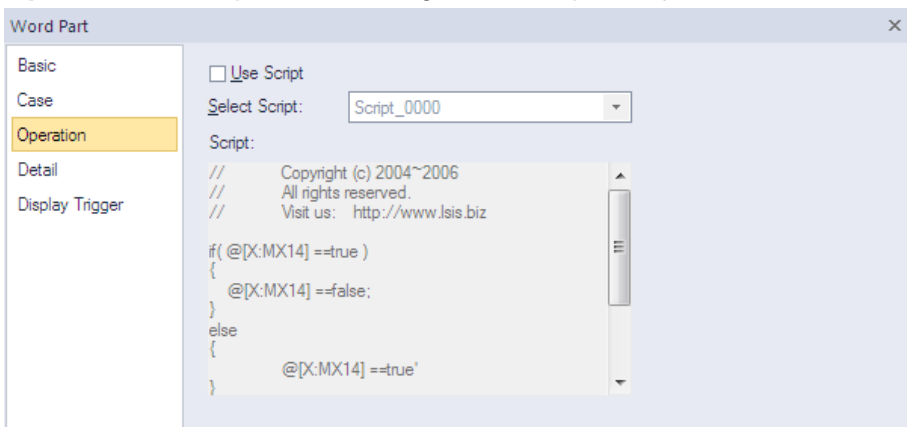

- **Use Script:** Check the checkbox to use a script with the object.
- **Select Script:** Select a script from the drop-down list.
- **Script:** When you select a script, it appears here. To modify a script, refer to <4.2 >.

- **Detail:** The detail settings for word part objects are shown in the below screenshot.

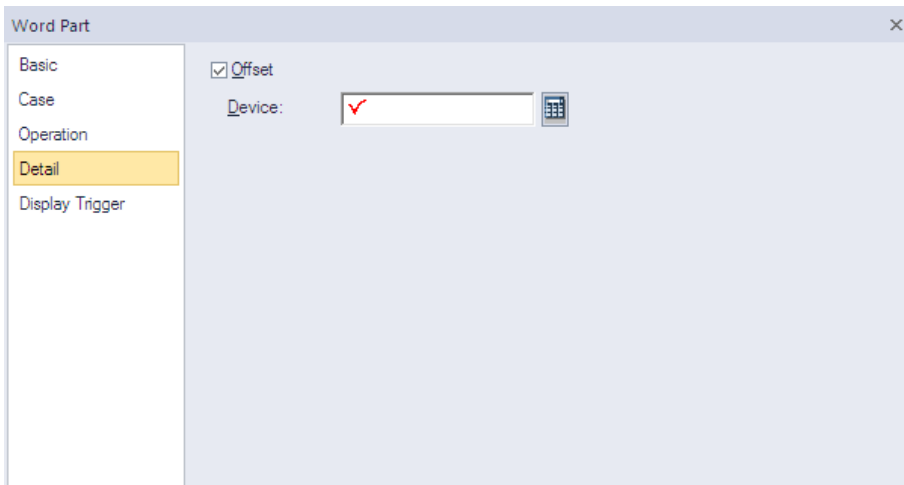

- **Offset:** Check the checkbox to use the Offset function. You can offset the device address based on the value of the offset device. For example, if the starting device address is P100, XP-Builder reads the value from the offset device and offsets the address by that value. If the offset value is 10, for example, then the referenced device address is P110.
- **Device:** Enter a device or tag address directly into the input field or click the keypad icon to the right to specify a device or tag address. When you click the keypad icon to open the Device window you can also specify network settings, if necessary.

- **Display Trigger:** The display trigger settings for word part objects are shown in the below screenshot.

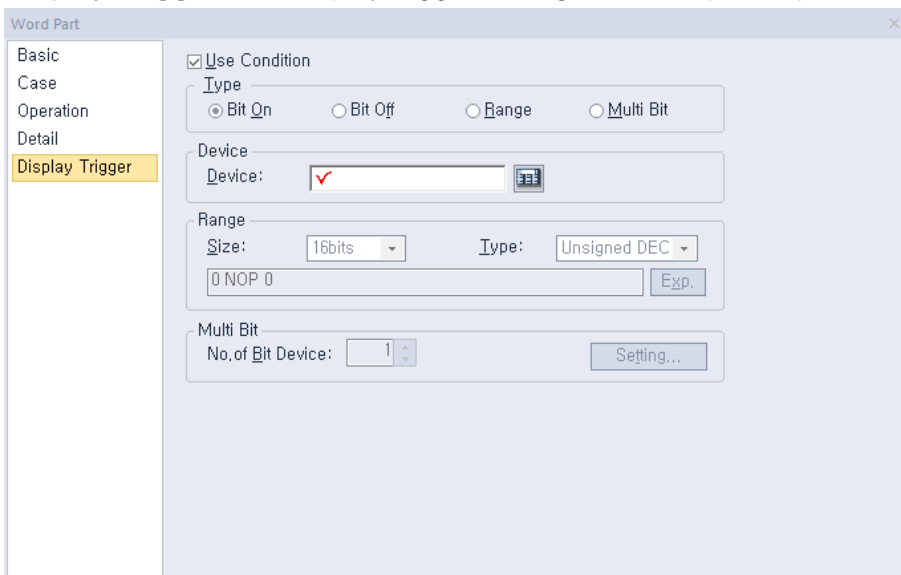

- **Use Condition:** Set whether or not to specify a condition for the action.
- **Type:** Set a type of condition to specify.

Bit On	The action is performed when the device is switched on.
Bit Off	The action is performed when the device is switched off.
Range	The action is performed when the value falls within the specified range.

Multi Bit	The action is performed when the logical operation result of multiple devices is met.
------------------	---

- **Device:** Enter a device or tag address directly into the input field or click the keypad icon to the right to specify a device or tag address. When you click the keypad icon to open the Device window, you can also specify network settings, if necessary.
- **Range:** If you select the range condition, specify the range.

Size	16 bit or 32 bit.
Type	Signed decimal, unsigned decimal, BCD, or float.
Exp.	Click to designate the expression as conditional.

- **Multi Bit:** If you select the multi bit condition, specify the number of bits and click [Setting] to specify the bit conditions.

4.3.7 Animation Object

Animation objects allow you to display moving images (GIFs) based on the device conditions.

- **Animation:** The animation settings for animation objects are shown in the below screenshot.

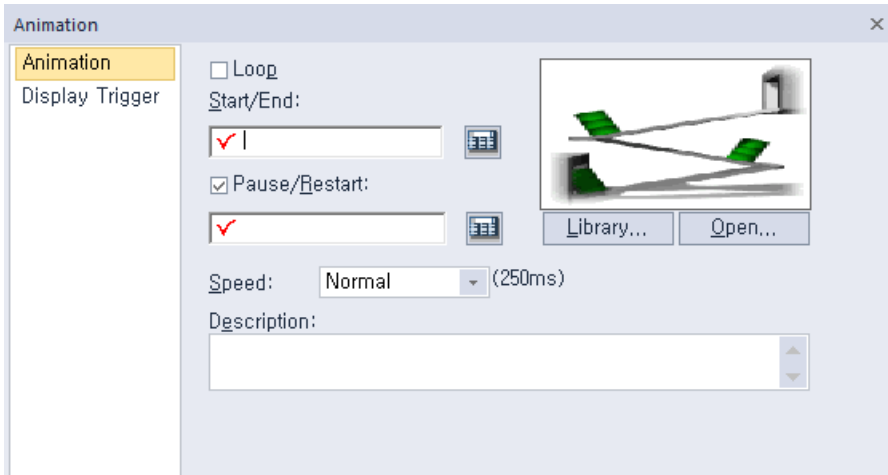

- **Loop:** Set whether or not to repeat the animation. If you set this option, you cannot set the Start/End or Pause/Restart devices.
- **Start/End:** Set a bit device to start and end the animation.
- **Pause/Restart:** Set a device to pause or resume the animation halfway.
- **Library:** Click to select an animation from the user or system graphic libraries.
- **Open:** Click to select a GIF file from your computer.
- **Speed:** Set the speed of the animation.

Slow	400 ms
Normal	250 ms
Fast	100 ms

- **Description:** Enter a description of the relevant object.

Note

Depending on the operation speed and the image size, animation objects can overload the system and affect the overall performance.

In projects other than WXP, animated gifs "The original image cannot exceed 256 pixels in width and length, and the number of frames cannot exceed 16. Check the above constraints when registering with the library or checking for data errors.

If the animation object is not connected to PLC device when setting Start / End, Pause / Restart device, it displays the image of stop status.

※ For details, refer to <Appendix 5. Object Display Rule before Communication Connection>.

- **Display Trigger:** The display trigger settings for animation objects are shown in the below screenshot.

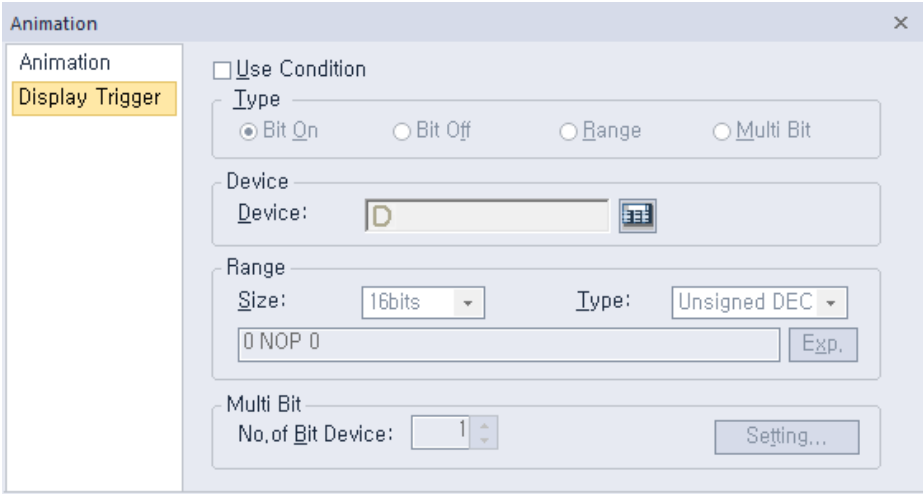

- **Use Action Condition:** Set whether or not to specify a condition for the action.
- **Type:** Set a type of condition to specify.

Bit On	The action is performed when the device is switched on.
Bit Off	The action is performed when the device is switched off.
Range	The action is performed when the value falls within the specified range.
Multi Bit	The action is performed when the logical operation result of multiple devices is met.

- **Device:** Enter a device or tag address directly into the input field or click the keypad icon to the right to specify a device or tag address. When you click the keypad icon to open the Device window, you can also specify network settings, if necessary.
- **Range:** If you select the range condition, specify the range.

Size	16 bit or 32 bit.
Type	Signed decimal, unsigned decimal, BCD, or float.
Exp.	Click to designate the expression as conditional.

- **Multi Bit:** If you select the multi bit condition, specify the number of bits and click [Setting] to specify the bit conditions.

4.3.8 Graph Objects

You can use graph objects to express various device values. Eight types of graphs are available, including bar, pie, meter, closed, trend, logging trend, logging scatter, and real-time scatter graphs.

Note

- If the graph object is not connected to a PLC device, only graph background and scale are displayed.
 - ✘ For details, refer to <Appendix 5. Object Display Rule before Communication Connection>.

4.3.8.1 Bar Graph

The following sections describe options available for bar graphs.

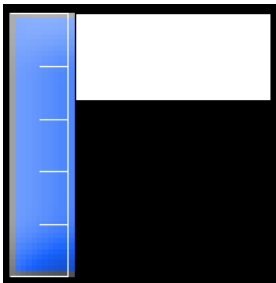

- **Basic:** The basic settings for bar graph objects are shown in the below screenshot.

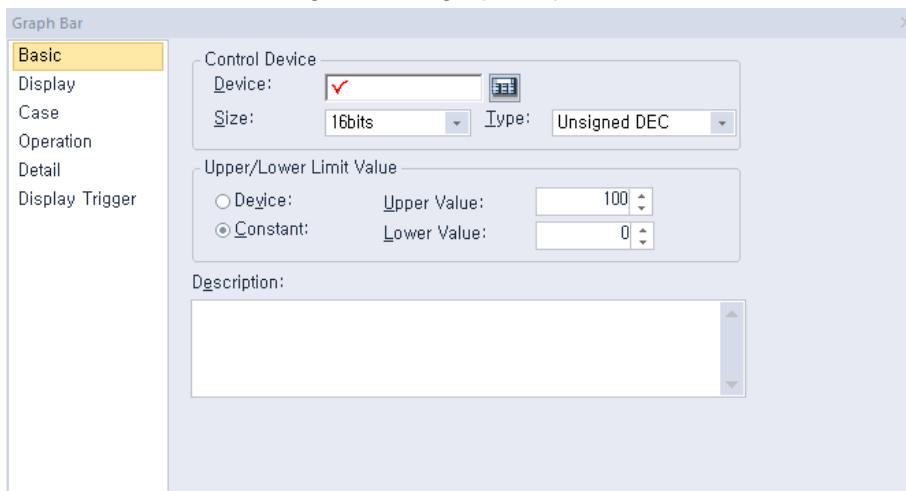

- **Control Device:** Specify the following options for the control device.

Device	Enter a device or tag address directly into the input field or click the keypad icon to the right to specify a device or tag address. When you click the keypad icon to open the Device window, you can also specify network settings, if necessary.
Size	Set the data size of the device (16 bit or 32 bit). If you change the data size of an existing object, the conditional statement will be deleted.
Type	Set the data form at the device (signed decimal, unsigned decimal, BCD, or float). If you change the data type of an existing object, the

conditional statement will be deleted.

- **Upper/Lower Limit Value:** Set the maximum and minimum values of the data to display. The maximum and minimum values must be within the range supported by the device type. Otherwise, only the minimum or maximum value supported by the device will be displayed.

Device	Set the specified device value as the maximum and minimum value.
Constant	Set the specified fixed value as the maximum and minimum value.

Note

Refer to the following table for the minimum and maximum constant values based on the device size:

Device size	Device type	Minimum	Maximum
16bit	Signed decimal	-32768	32767
16bit	Unsigned decimal	0	65535
16bit	BCD	0	9999
32bit	Signed decimal	-2147483648	2147483647
32 bit	Unsigned decimal	0	4294967295
32 bit	BCD	0	99999999

- **Description:** Enter a description of the relevant object.

- **Display:** The display settings for bar graph objects are shown in the below screenshot.

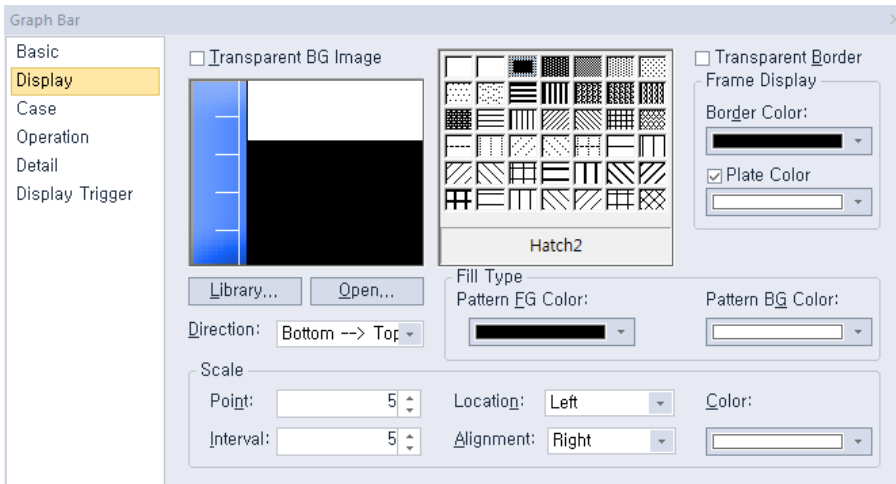

- **Transparent BG Image:** Set whether or not to make the background of the graph transparent.
- **Library:** Click to select a background image for the graph from an image library.
- **Open:** Click to search for a background image for the graph on your computer.
- **Direction:** Set the direction of the graph (top > bottom, bottom > top, left > right, or right > left).
- **Hatch:** Set a pattern for the ranges in the graph.
- **Transparent Border:** Set whether or not to use a transparent border for the graph.
- **Frame Display:** Specify the following options for the frame.

Border Color	Select a border color.
---------------------	------------------------

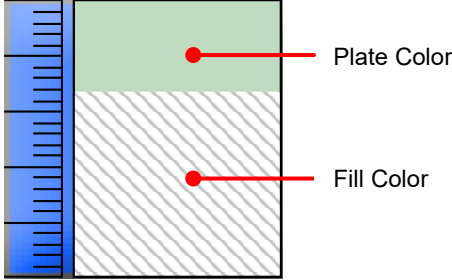
Plate Color	<p>Select the background for areas not filled by value ranges.</p> 
--------------------	---

- **Fill Type:** Specify the following options for the fill.

Pattern FG Color	Select a foreground color for the pattern.
Pattern BG Color	Select a background color for the pattern.



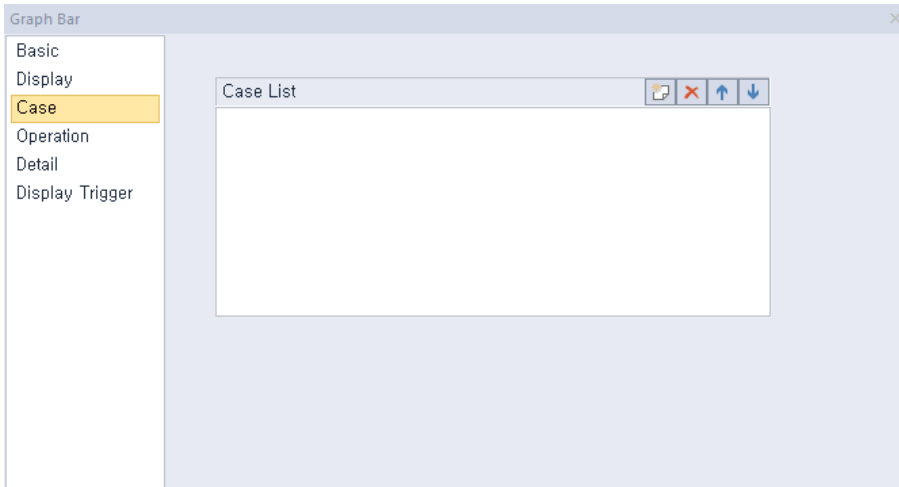

- **Scale:** Specify the following options for the scale.

Point	Set the number of points in the scale. The number can be set from 0 to 255. Every fifth point is displayed longer than other points and the size of the points differ by graph. If the number of points is 0, other options cannot be set.
Interval	Set the space between points on the graph (0 to 10).
Location	Set the location of the scale in the graph.
Alignment	Set the alignment of points in the scale. If the location of the scale is to the left or right, the alignment can be set as left or right. If the location of the scale is at the top or bottom, the alignment can be set as top or bottom.
Color	Set the color of the scales.

- **Case:** The case settings for bar graph object are shown in the below screenshot.



- **Case List:** Create, delete, or reorganize conditional expressions.

 (Create)	Click to create a new range condition. You can create up to eight conditions. Clicking this icon opens the Range Edit window, which allows you to create a condition. For more information, refer to <4.2.1.3 Understanding Constants and Data Types> .
 (Delete)	Click a condition and then click this icon to delete the condition.
 (Up)	Click a condition and then click this icon to move it higher up the list.
 (Down)	Click a condition and then click this icon to move it lower down the list.

When you create a range condition, you can also set the fill type of the graph.

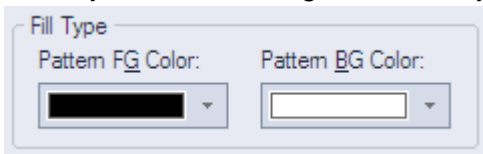

Pattern FG Color	Set the foreground color of the graph to display when the condition is met.
Pattern BG Color	Set the background color of the graph to display when the condition is met.

- **Operation:** The operation settings for bar graph objects are shown in the screenshot below.

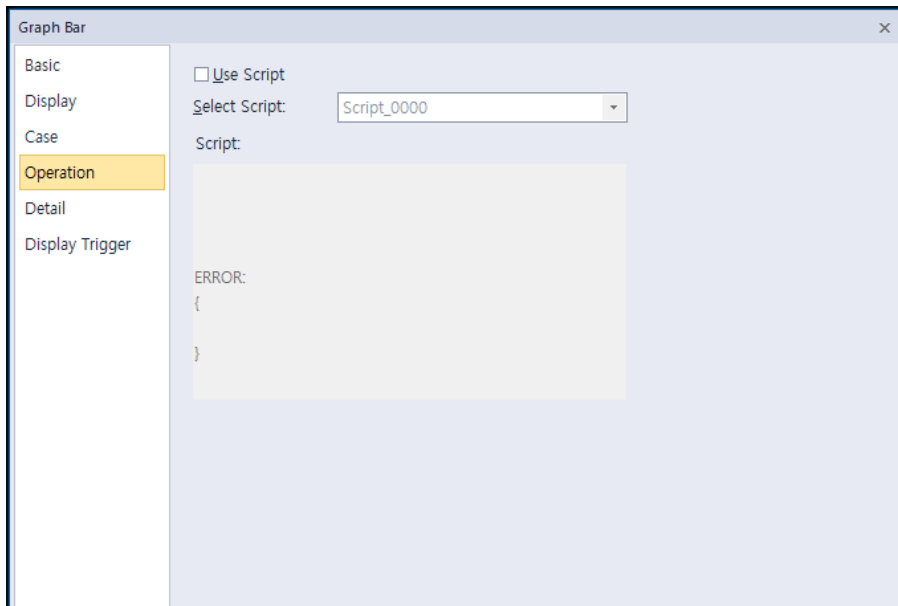

- **Use Script:** Check the checkbox to use a script with the object.
 - **Select Script:** Select a script from the drop-down list.
 - **Script:** When you select a script, it appears here. To modify a script, refer <4.2 >
- **Detail:** The detail settings for bar graph objects are shown in the below screenshot.

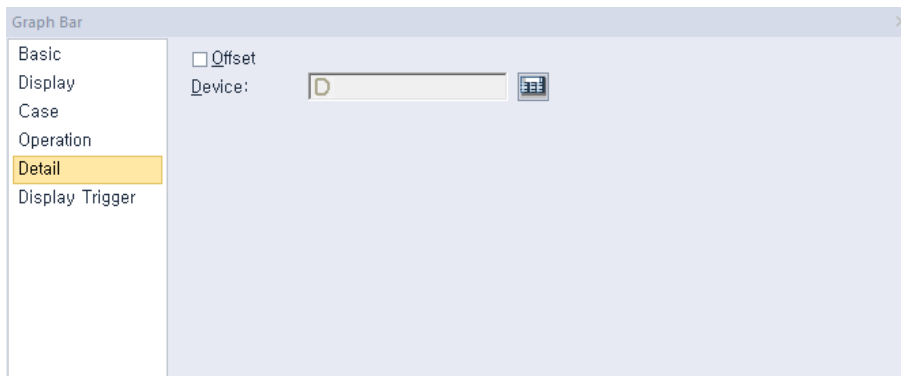

- **Offset:** Check the checkbox to use the Offset function. You can offset the device address based on the value of the offset device. For example, if the starting device address is P100, XP-Builder reads the value from the offset device and offsets the address by that value. If the offset value is 10, for example, then the referenced device address is P110.
- **Device:** Enter a device or tag address directly into the input field or click the keypad icon to the right to specify a device or tag address. When you click the keypad icon to open the Device window, you can also specify network settings, if necessary.

- **Display Trigger:** The display trigger settings for bar graph objects are shown in the below screenshot.

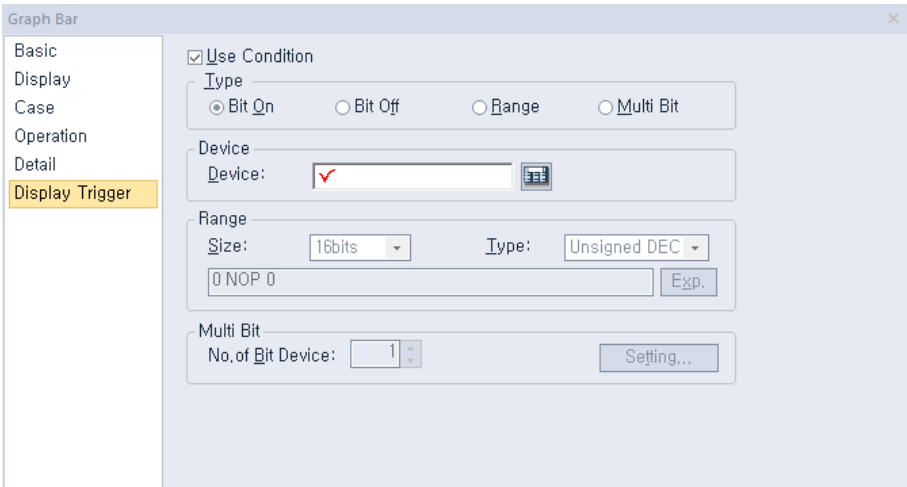

- **Use Condition:** Set whether or not to specify a condition for the action.
- **Type:** Set a type of condition to specify.

Bit On	The action is performed when the device is switched on.
Bit Off	The action is performed when the device is switched off.
Range	The action is performed when the value falls within the specified range.
Multi Bit	The action is performed when the logical operation result of multiple devices is met.

- **Device:** Enter a device or tag address directly into the input field or click the keypad icon to the right to specify a device or tag address. When you click the keypad icon to open the Device window, you can also specify network settings, if necessary.
- **Range:** If you select the range condition, specify the range.

Size	16 bit or 32 bit.
Type	Signed decimal, unsigned decimal, BCD, or float.
Exp.	Click to designate the expression as conditional.

- **Multi Bit:** If you select the multi bit condition, specify the number of bits and click [Setting] to specify the bit conditions.

4.3.8.2 Pie Graph

The following sections describe the available options for pie graph objects.

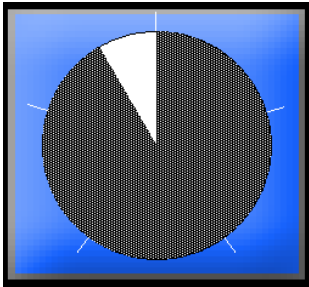

- **Basic:** The basic settings for pie graph objects are shown in the below screenshot.

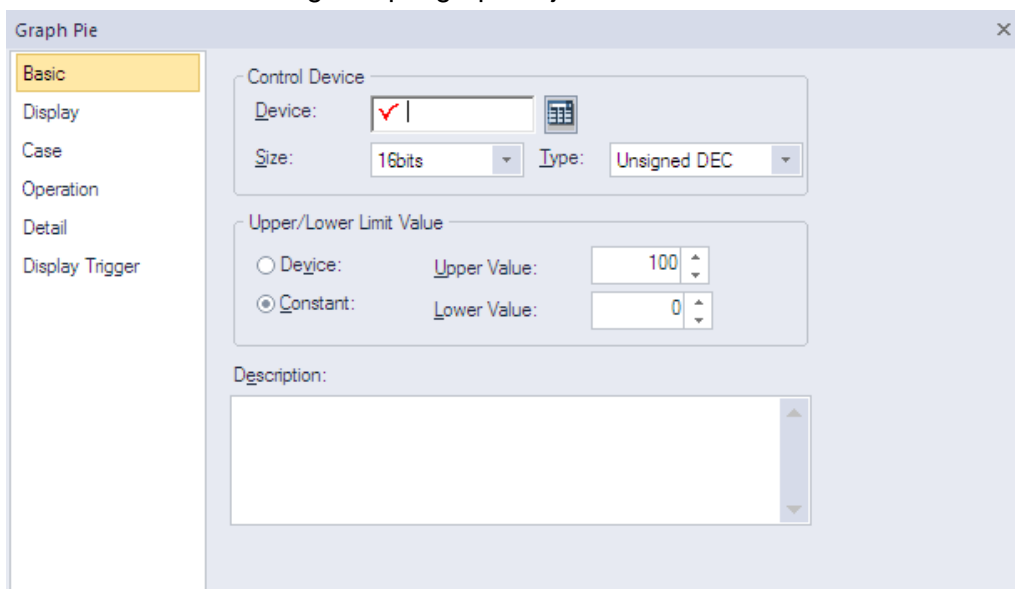

- **Control Device:** Specify the following options for the control device.

Device	Enter a device or tag address directly into the input field or click the keypad icon to the right to specify a device or tag address. When you click the keypad icon to open the Device window, you can also specify network settings, if necessary.
Size	Set the data size of the device (16 bit or 32 bit). If you change the data size of an existing object, the conditional statement will be deleted.
Type	Set the data form at the device (signed decimal, unsigned decimal, BCD, or float). If you change the data type of an existing object, the conditional statement will be deleted.

- **Upper/Lower Limit Value:** Set the maximum and minimum values of the data to display. The maximum and minimum values must be within the range supported by the device type. Otherwise, only the minimum or maximum value supported by the device will be displayed.

Device	Set the specified device value as the maximum and minimum value.
Constant	Set the specified fixed value as the maximum and minimum value.

Note

Refer to the following table for the minimum and maximum constant values based on the device size:

Device size	Device type	Minimum	Maximum
16bit	Signed decimal	-32768	32767
16bit	Unsigned decimal	0	65535
16bit	BCD	0	9999
32bit	Signed decimal	-2147483648	2147483647
32 bit	Unsigned decimal	0	4294967295
32 bit	BCD	0	99999999

- If the number of channels is 2 or more, the device of each channel is set as a continuous device based on the input device.
 - Example) Input device: HW00000, if the size is 16bit, set the second channel device to HW00001
 - Example) Input device: HW00000, if the size is 32bit, set the second channel device to HW00002
- If the number of channels is 2 or more, only the positive number greater than 0 can be entered for device input.

– **Description:** Enter a description of the relevant object.

- **Display:** The display settings for pie graph objects are shown in the below screenshot.

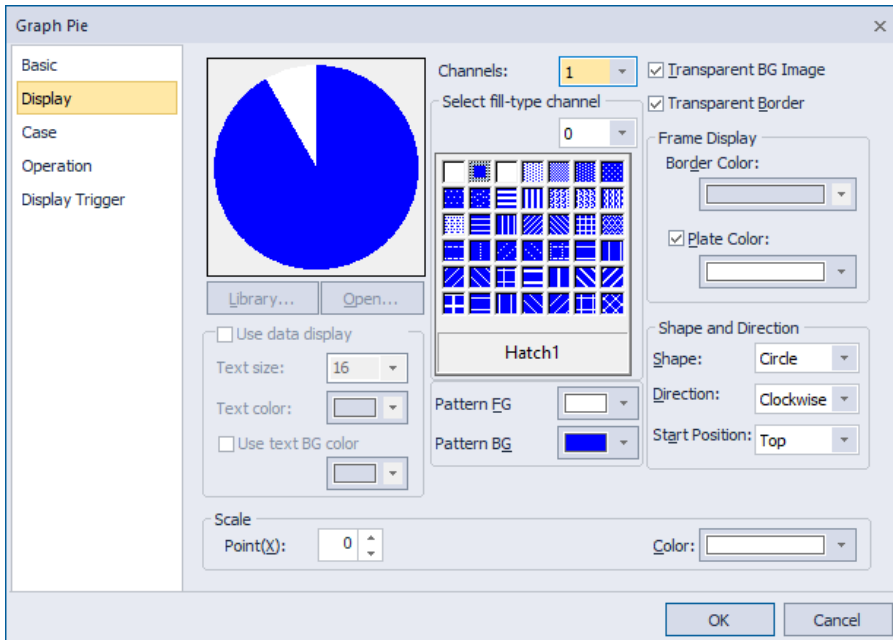

- **Channels:** Input the number of items to display on pie graph.
- **Library:** Click to select a background image for the graph from an image library.
- **Open:** Click to search for a background image for the graph on your computer.
- **Hatch:** Set a pattern for the ranges in the graph.
- **Transparent BG Image:** Set whether or not to make the background of the graph transparent.

- **Transparent Border:** Set whether or not to use a transparent border for the graph.
- **Frame Display:** Specify the following options for the frame.

Border Color	Select a border color.
Plate Color	Select the background for areas not filled by value ranges.

- **Fill Type:** Specify the following options for the fill.

Pattern FG Color	Set a foreground color for the pattern.
Pattern BG Color	Set a background color for the pattern.

- **Shape and Direction:** Specify the following options for the shape and direction.

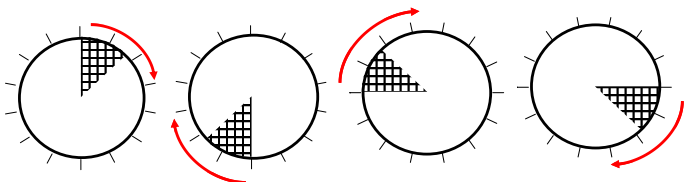
Shape	Set the shape of the pie chart (circle, top-half circle, bottom-half circle, left-half circle, right-half circle, top-fan, bottom-fan, left-fan, right-fan, and 3/4 fan).
Direction	Set the direction for filling the pie graph (clockwise or counter-clockwise).
Start Position	When using a circle shape, set the start position of the pointer. If the direction is clockwise, the start position is as follows. 

- **Scale:** Specify the following options for the scale.

Point	Set the number of points in the scale.
Color	Set the color of the scales.

Setting when the number of channels is 2 or more:

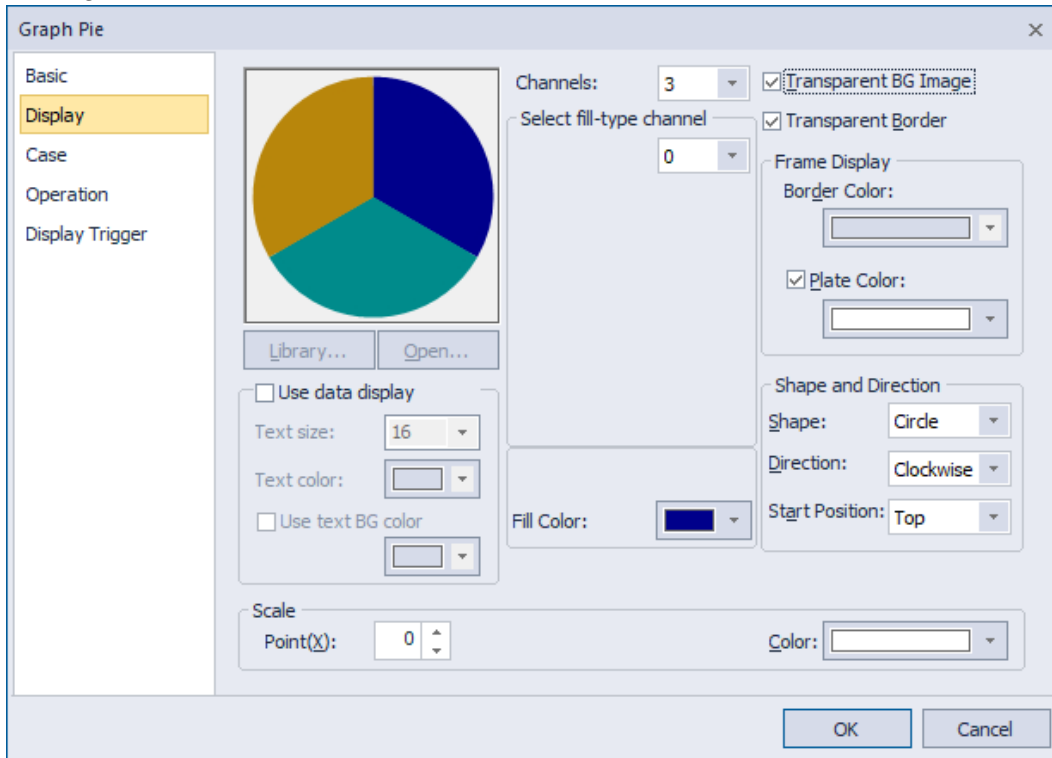

- **Select fill-type channel:** Enter the channel number to set the fill color, or select the channel number from the drop-down list.
- **Use Data display:** Displays the ratio of the value of each channel to the value of all channels is %.



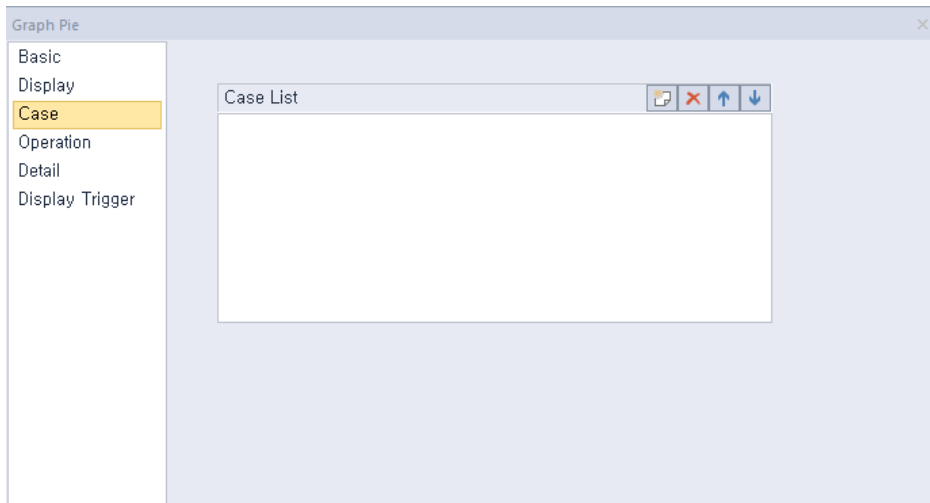

Text size	Set the size of the displayed text.
Text color	Set the color of the displayed text.
Use text BG color	Set the background color of the displayed text.

- **Fill Color:** Set the fill color of pie portion of each channel.

- **Case:** The case settings for pie graph objects are shown in the below screenshot.



- **Case List:** Create, delete, or reorganize conditional expressions.

 (Create)	Click to create a new range condition. You can create up to eight conditions. Clicking this icon opens the Range Edit window, which allows you to create a condition. For more information, refer to <4.2.1.3 Understanding Constants and Data Types> .
 (Delete)	Click a condition and then click this icon to delete the condition.
 (Up)	Click a condition and then click this icon to move it higher up the list.
 (Down)	Click a condition and then click this icon to move it lower down the list.

When you create a range condition, you can also set the fill type of the graph.

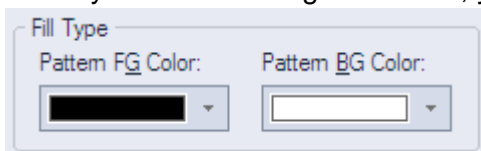

Pattern FG Color	Set the foreground color of the graph to display when the condition is met.
Pattern BG Color	Set the background color of the graph to display when the condition is met.

- **Operation:** The operation settings for pie graph objects are shown in the below screenshot.

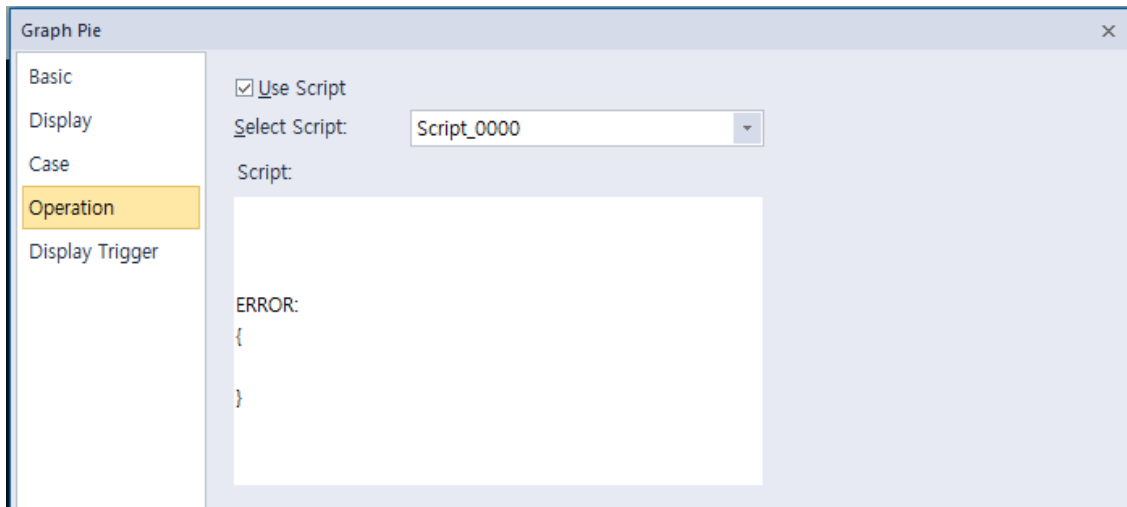

- **Use Script:** Check the checkbox to use a script with the object.
 - **Select Script:** Select a script from the drop-down list.
 - **Script:** When you select a script, it appears here. To modify a script, refer to [<4.2 Scripts>](#).
- **Detail:** The detail settings for pie graph objects are shown in the below screenshot.

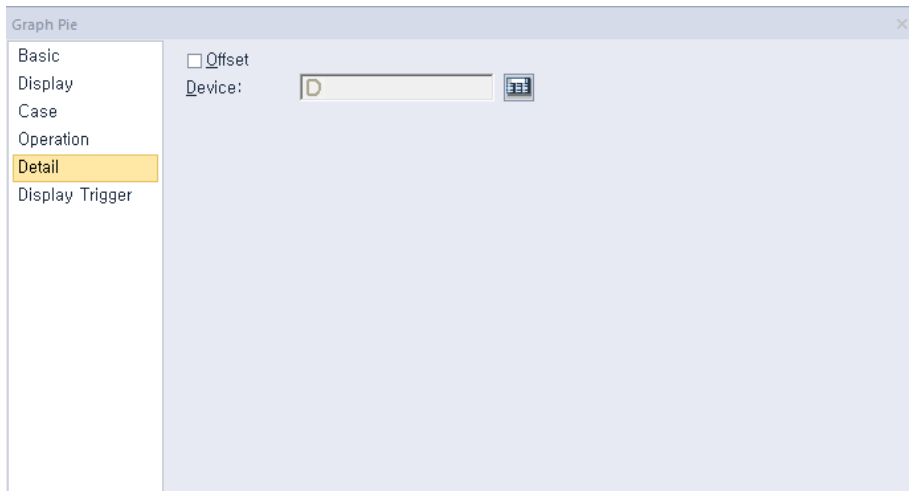

- **Offset:** Check the checkbox to use the Offset function. You can offset the device address based on the value of the offset device. For example, if the starting device address is P100, XP-Builder reads the value from the offset device and offsets the address by that value. If the offset value is 10, for example, then the referenced device address is P110.
- **Device:** Enter a device or tag address directly into the input field or click the keypad icon to the right to specify a device or tag address. When you click the keypad icon to open the Device window, you can also specify network settings, if necessary.

- **Display Trigger:** The display trigger settings for pie graph objects are shown in the below screenshot.

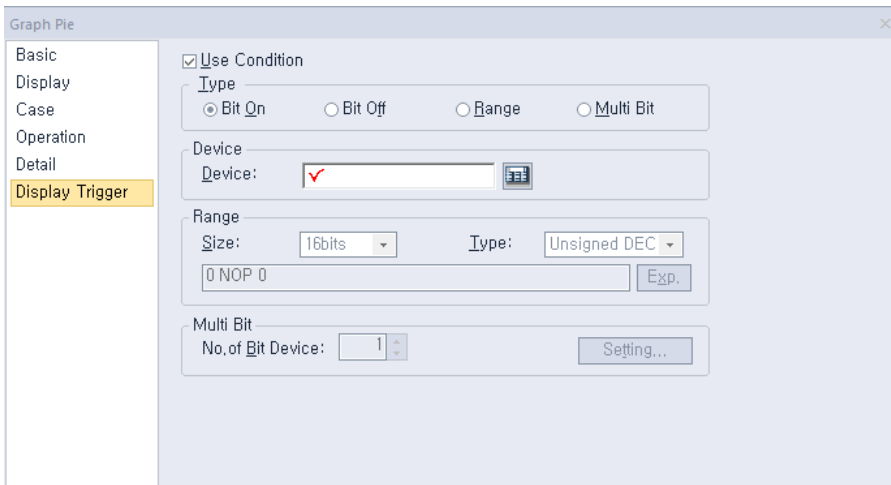

- **Use Condition:** Set whether or not to specify a condition for the action.
- **Type:** Set a type of condition to specify.

Bit On	The action is performed when the device is switched on.
Bit Off	The action is performed when the device is switched off.
Range	The action is performed when the value falls within the specified range.
Multi Bit	The action is performed when the logical operation result of multiple devices is met.

- **Device:** Enter a device or tag address directly into the input field or click the keypad icon to the right to specify a device or tag address. When you click the keypad icon to open the Device window, you can also specify network settings, if necessary.
- **Range:** If you select the range condition, specify the range.

Size	16 bit or 32 bit.
Type	Signed decimal, unsigned decimal, BCD, or float.
Exp.	Click to designate the expression as conditional.

- **Multi Bit:** If you select the multi bit condition, specify the number of bits and click [Setting] to specify the bit conditions.

4.3.8.3 Meter Graph

The following sections describe available options for meter graphs.

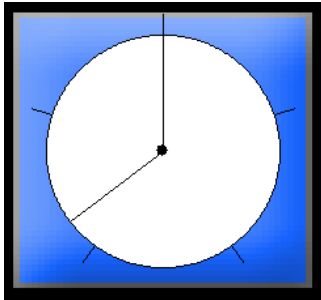

- **Basic:** The basic settings for meter graph objects are shown in the below screenshot.

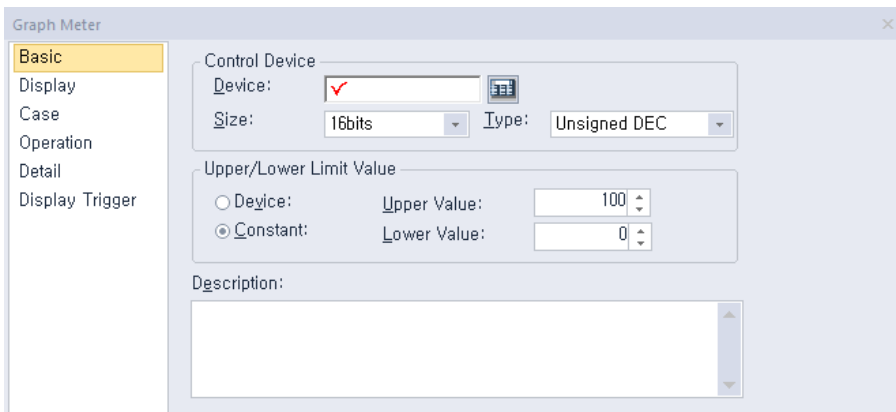

- **Control Device:** Specify the following options for the control device.

Device	Enter a device or tag address directly into the input field or click the keypad icon to the right to specify a device or tag address. When you click the keypad icon to open the Device window, you can also specify network settings, if necessary.
Size	Set the data size of the device (16 bit or 32 bit). If you change the data size of an existing object, the conditional statement will be deleted.
Type	Set the data form at the device (signed decimal, unsigned decimal, BCD, or float). If you change the data type of an existing object, the conditional statement will be deleted.

- **Upper/Lower Limit Value:** Set the maximum and minimum values of the data to display. The maximum and minimum values must be within the range supported by the device type. Otherwise, only the minimum or maximum value supported by the device will be displayed.

Device	Set the specified device value as the maximum and minimum value.
Constant	Set the specified fixed value as the maximum and minimum value.

Note

Refer to the following table for the minimum and maximum constant values based on the device size:

Device size	Device type	Minimum	Maximum
16bit	Signed decimal	-32768	32767
16bit	Unsigned decimal	0	65535
16bit	BCD	0	9999
32bit	Signed decimal	-2147483648	2147483647
32 bit	Unsigned decimal	0	4294967295
32 bit	BCD	0	99999999

- **Description:** Enter a description of the relevant object.
- **Display:** The display settings for meter graph objects are shown in the below screenshot.

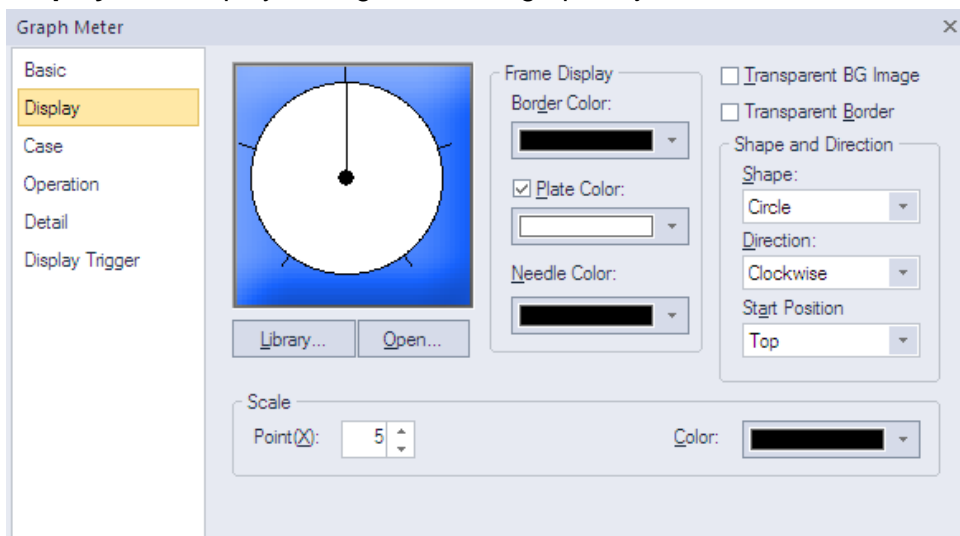

- **Library:** Click to select a background image for the graph from an image library.
- **Open:** Click to search for a background image for the graph on your computer.
- **Frame Display:** Specify the following options for the frame.

Border Color	Select a border color.
Plate Color	Select the background for areas not filled by value ranges.
Needle Color	Select the pointer color.

- **Transparent BG Image:** Set whether or not to make the background of the graph transparent.
- **Transparent Border:** Set whether or not to use a transparent border.
- **Shape and Direction:** Specify the following options for the shape and direction:

Shape	Set the shape of the graph.
Direction	Set the direction for filling the graph.
Start Position	When using a circle shape, set the starting position of the pointer. When using a circle shape, set the starting position of the pointer. If the direction is clockwise, the start position is as follows.

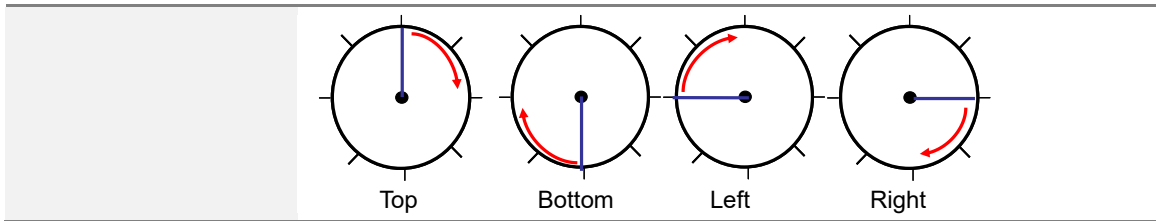



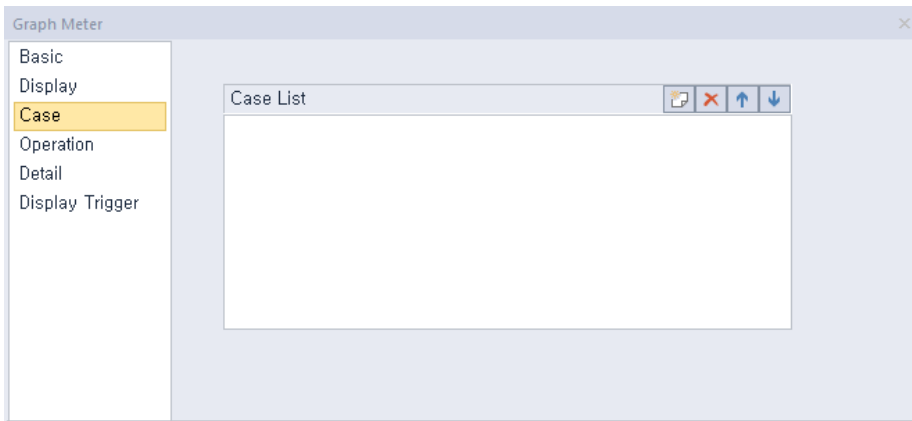

- **Scale:** Specify the following options for the scale.

Point	Set the number of points in the scale.
Color	Set the color of the scales.

- **Case:** The case settings for meter graph objects are shown in the below screenshot.



- **Case List:** Create, delete, or reorganize conditional expressions.

 (Create)	Click to create a new range condition. You can create up to eight conditions. Clicking this icon opens the Range Edit window, which allows you to create a condition. For more information, refer to <4.2.1.3 Understanding Constants and Data Types> .
 (Delete)	Click a condition and then click this icon to delete the condition.
 (Up)	Click a condition and then click this icon to move it higher up the list.
 (Down)	Click a condition and then click this icon to move it lower down the list.

When you create a range condition, you can also set the needle color of the graph to display when the condition is met.

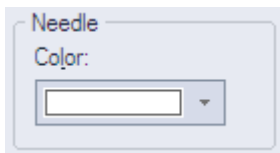

- **Operation:** The operation settings for meter graph objects are shown in the below screenshot.

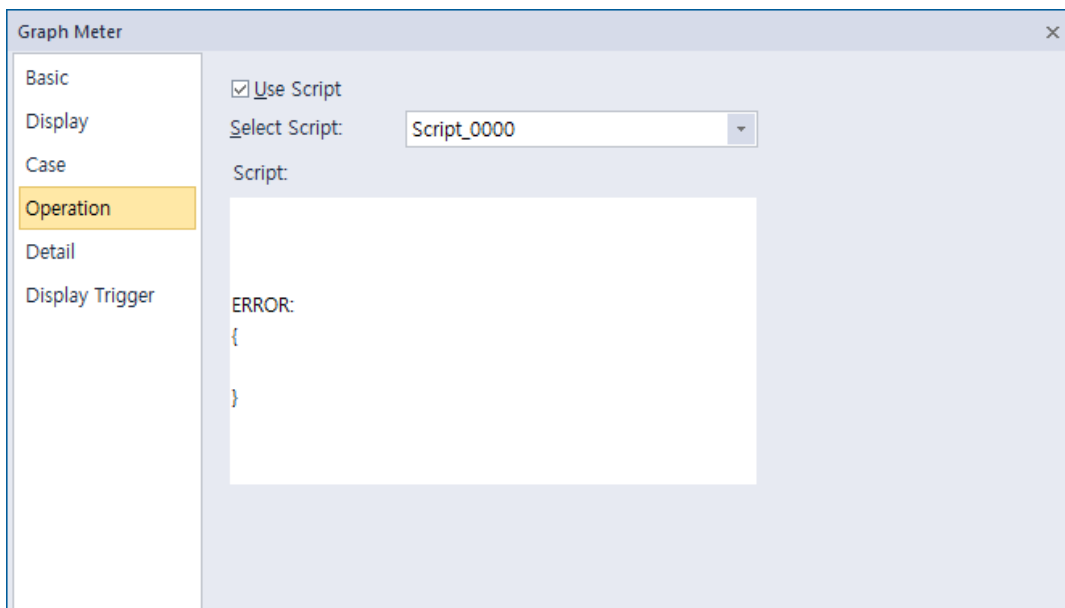

- **Use Script:** Check the checkbox to use a script with the object.
- **Select Script:** Select a script from the drop-down list.
- **Script:** When you select a script, it appears here. To modify a script, refer to <4.2 >.

- **Detail:** The detail settings for meter graph objects are shown in the below screenshot.

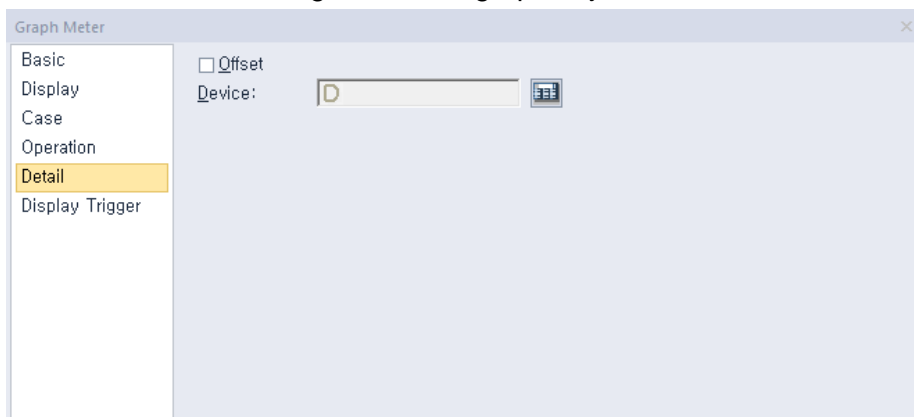

- **Offset:** Check the checkbox to use the Offset function. You can offset the device address based on the value of the offset device. For example, if the starting device address is P100, XP-Builder reads the value from the offset device and offsets the address by that value. If the offset value is 10, for example, then the referenced device address is P110.
- **Device:** Enter a device or tag address directly into the input field or click the keypad icon to the right to specify a device or tag address. When you click the keypad icon to open the Device window, you can also specify network settings, if necessary.

- **Display Trigger:** The display trigger settings for the meter graph object include the following.

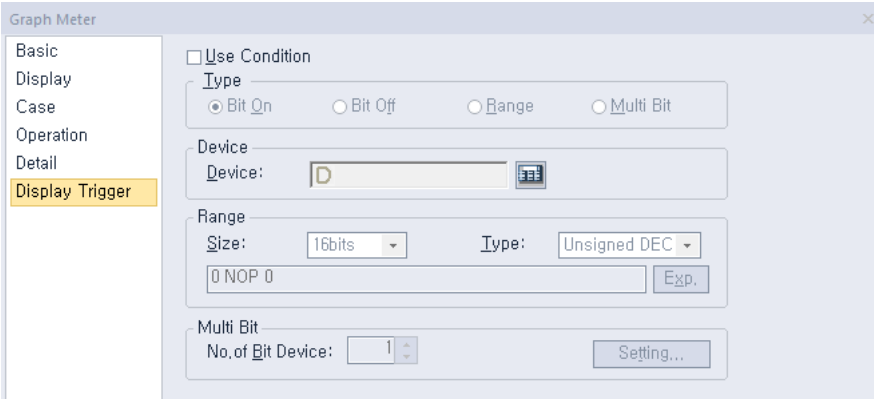

- **Use Condition:** Set whether or not to specify a condition for the action.
- **Type:** Set a type of condition to specify.

Bit On	The action is performed when the device is switched on.
Bit Off	The action is performed when the device is switched off.
Range	The action is performed when the value falls within the specified range.
Multi Bit	The action is performed when the logical operation result of multiple devices is met.

- **Device:** Enter a device or tag address directly into the input field or click the keypad icon to the right to specify a device or tag address. When you click the keypad icon to open the Device window, you can also specify network settings, if necessary.
- **Range:** If you select the range condition, specify the range.

Size	16 bit or 32 bit.
Type	Signed decimal, unsigned decimal, BCD, or float.
Exp.	Click to designate the expression as conditional.

- **Multi Bit:** If you select the multi bit condition, specify the number of bits and click [Setting] to specify the bit conditions.

4.3.8.4 Closed Graph

The following sections describe the options available for closed graph objects.

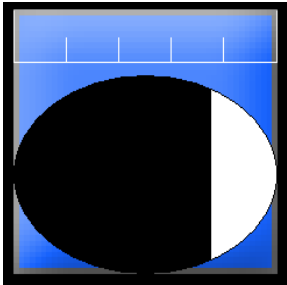

- **Basic:** The basic settings for closed graph objects include the following.

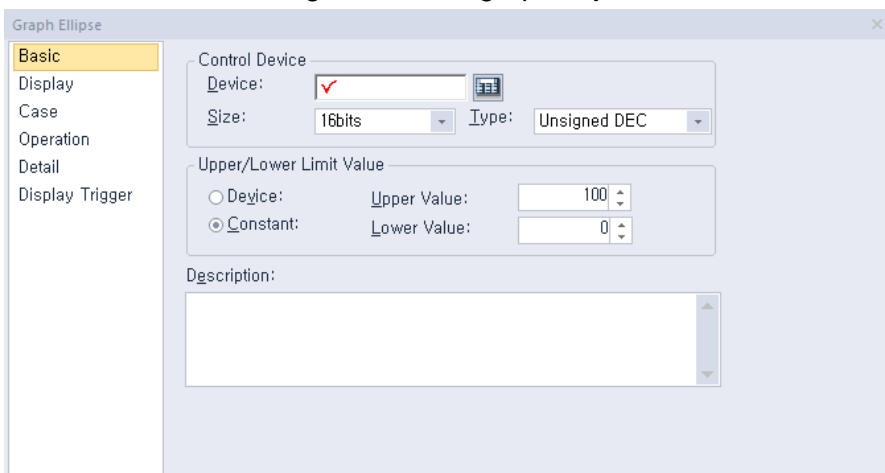

- **Control Device:** Specify the following options for the control device.

Device	Enter a device or tag address directly into the input field or click the keypad icon to the right to specify a device or tag address. When you click the keypad icon to open the Device window, you can also specify network settings, if necessary.
Size	Set the data size of the device (16 bit or 32 bit). If you change the data size of an existing object, the conditional statement will be deleted.
Type	Set the data form of the device (signed decimal, unsigned decimal, BCD, or float). If you change the data type of an existing object, the conditional statement will be deleted.

- **Upper/Lower Limit Value:** Set the maximum and minimum values of the data to display. The maximum and minimum values must be within the range supported by the device type. Otherwise, only the minimum or maximum value supported by the device will be displayed.

Device	Set the specified device value as the maximum and minimum value.
Constant	Set the specified fixed value as the maximum and minimum value.

Note

Refer to the following table for the minimum and maximum constant values based on the device size:

Device size	Device type	Minimum	Maximum
16bit	Signed decimal	-32768	32767
16bit	Unsigned decimal	0	65535
16bit	BCD	0	9999
32bit	Signed decimal	-2147483648	2147483647
32 bit	Unsigned decimal	0	4294967295
32 bit	BCD	0	99999999

- **Description:** Enter description in the relevant object.

- **Display:** The display settings for closed graph objects include the following.

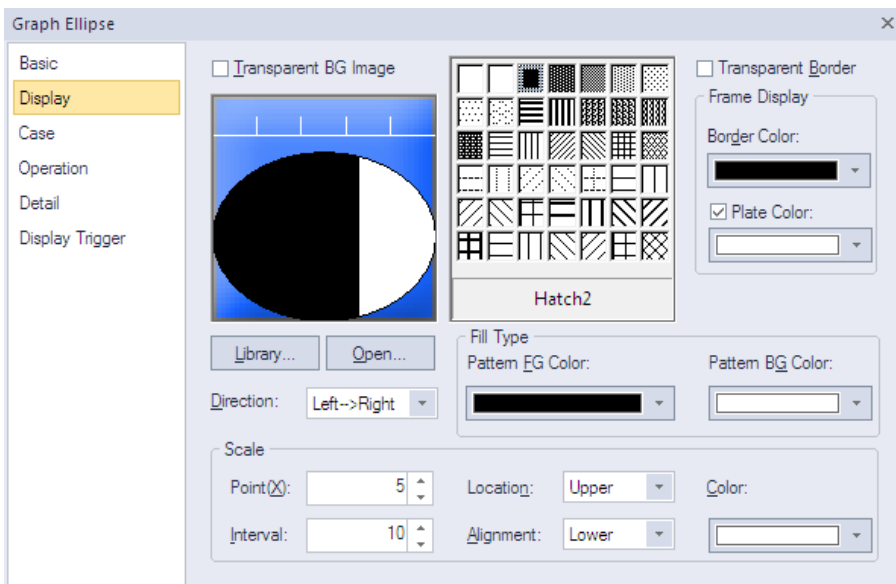

- **Transparent BG Image:** Set whether or not to make the background of the graph transparent.
- **Library:** Click to select a background image for the graph from a library.
- **Open:** Click to locate background image for the graph on your computer.
- **Direction:** Set the direction for filling the graph (Top > Bottom, Bottom > Top, Left > Right, or Right > Left).
- **Hatch:** Select the pattern for the filled areas of the graph.
- **Transparent Border:** Set whether or not to use a transparent border.
- **Frame Display:** Specify the following options for the frame.

Border Color	Set a border color.
Plate Color	Set the background for areas not filled by value ranges.

- **Fill Type:** Specify the following options for the fill.

Pattern FG Color	Set the foreground color for the pattern.
Pattern BG Color	Set the background color for the pattern.



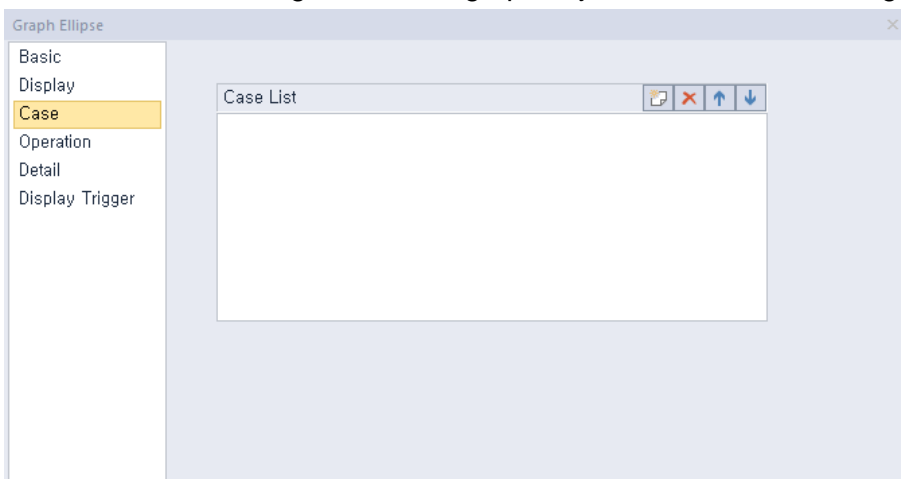

- **Scale:** Specify the following options for the scale.

Point	Set the number of points in the scale. The number can be set from 0 to 255. Every fifth point is displayed longer than other points and the size of the points differ by graph. If the number of points is 0, other options cannot be set.
Interval	Set the space between points on the graph (0 to 10).
Location	Set the location of the scale in the graph.
Alignment	Set the alignment of points in the scale. If the location of the scale is left or right, the alignment can be set in left or right. If the location of the scale is top or bottom, the alignment can be set in top or bottom.
Color	Set the color of the scales.

- **Case:** The case settings for closed graph object include the following.



- **Case List:** Create, delete, or reorganize conditional expressions:

 (Create)	Click to create a new range condition. You can create up to eight conditions. Clicking this button opens the Range Edit window, which allows you to create a condition. For more information, refer to <4.2.1.3 Understanding Constants and Data Types> .
 (Delete)	Click a condition and then click this icon to delete the condition.
 (Up)	Click a condition and then click this icon to move it higher up the list.
 (Down)	Click a condition and then click this icon to move it lower down the list.

When you create a range condition, you can also set the fill type of the graph.

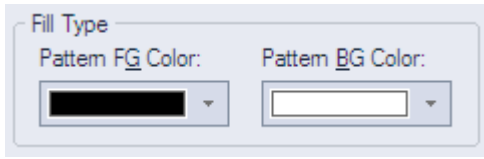

Pattern FG Color	Set the foreground color of the graph to display when the condition is met.
Pattern BG Color	Set the background color of the graph to display when the condition is met.

- **Operation:** The operation settings for closed graph object include the following.

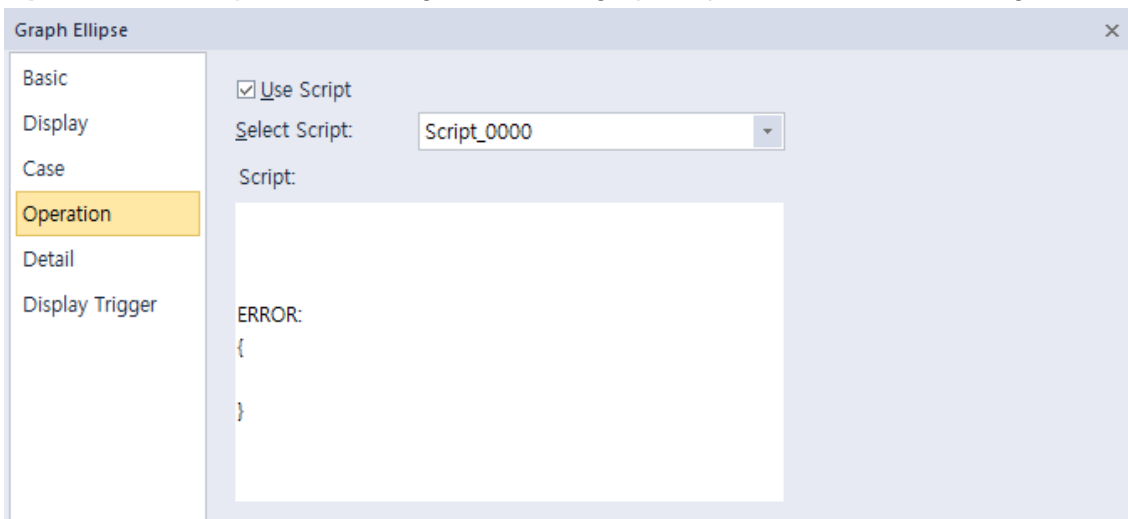

- **Use Script:** Click the checkbox to use a script with the object.
- **Select Script:** Select a script from the drop-down list.
- **Script:** When you select a script, it appears here. To modify a script, refer to refer to **<4.2 Scripts>**.

- **Detail:** The detail settings for closed graph object include the following.

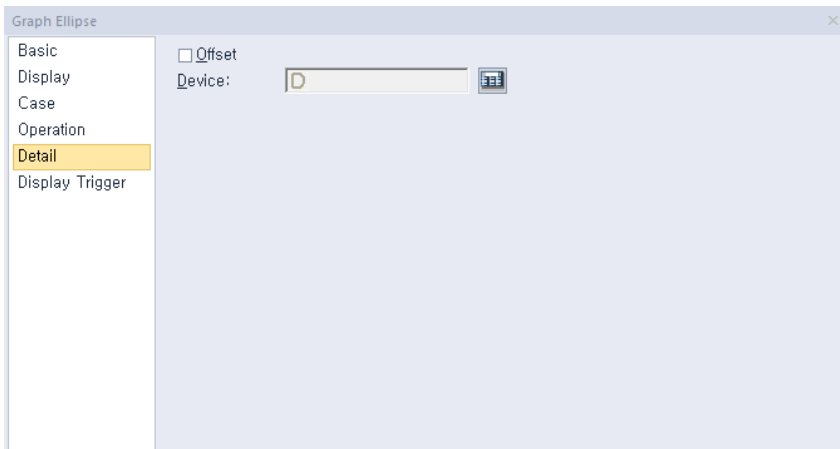

- **Offset:** Click the checkbox to use the offset function. You can offset the device address based on the value of the offset device. For example, if the starting device address is P100, XP-Builder reads the value from the offset device and offsets the address by that value. If the offset value is 10, for example, then the referenced device address is P110.
- **Device:** Enter a device or tag address directly into the input field or click the keypad icon to the right to specify a device or tag address. When you click the keypad icon to open the Device window, you can also specify network settings, if necessary.

- **Display Trigger:** The display trigger settings for the closed graph object include the following.

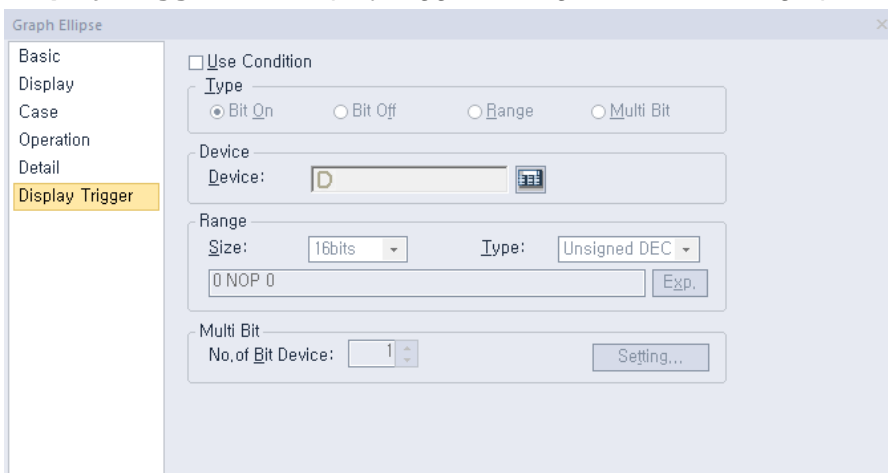

- **Use Condition:** Set whether or not to specify a condition for the action.
- **Type:** Set a type of condition to specify.

Bit On	The action is performed when the device is switched on.
Bit Off	The action is performed when the device is switched off.
Range	The action is performed when the value falls within the specified range.
Multi Bit	The action is performed when the logical operation result of multiple devices is met.

- **Device:** Enter a device or tag address directly into the input field or click the keypad icon to the right to specify a device or tag address. When you click the keypad icon to open the Device window, you can also specify network settings, if necessary.
- **Range:** If you select the range condition, specify the range.

Size	16 bit or 32 bit.
Type	Signed decimal, unsigned decimal, BCD, or float.
Exp.	Click to designate the expression as conditional.

- **Multi Bit:** If you select the multi bit condition, specify the number of bits and click [Setting] to specify the bit conditions.

4.3.8.5 Trend Graph

The following sections describe available options for trend graphs.

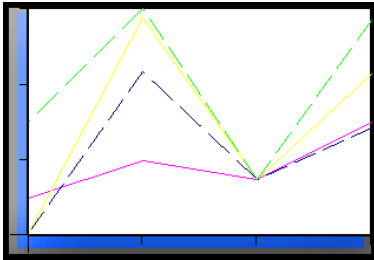

Note

- Only the data points on the X axis (time axis) that are collected most recently according to the current time will be displayed on the screen. That is, the previous values of the current time (acquisition interval X the number of points on the X axis) will be displayed.

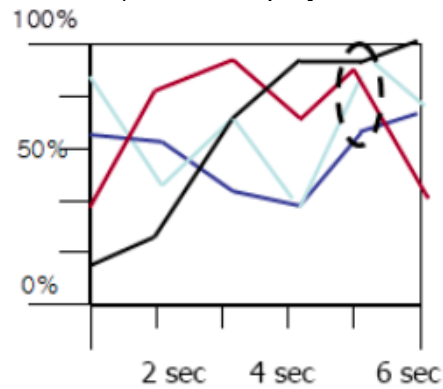
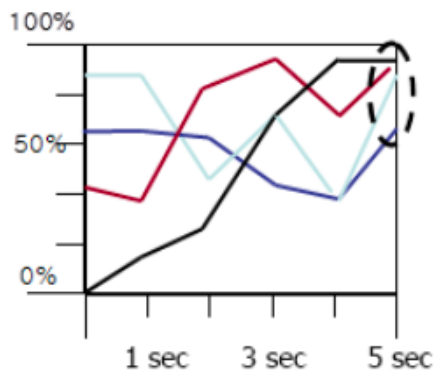

- When the screen shifts, communication may stop and resume. If a communication delay occurs, graphs may not appear correctly. If communication fails for a short time because of environmental factors such as noise, graphs may not appear correctly.

- **Basic:** The basic settings for the trend graph object include the following.

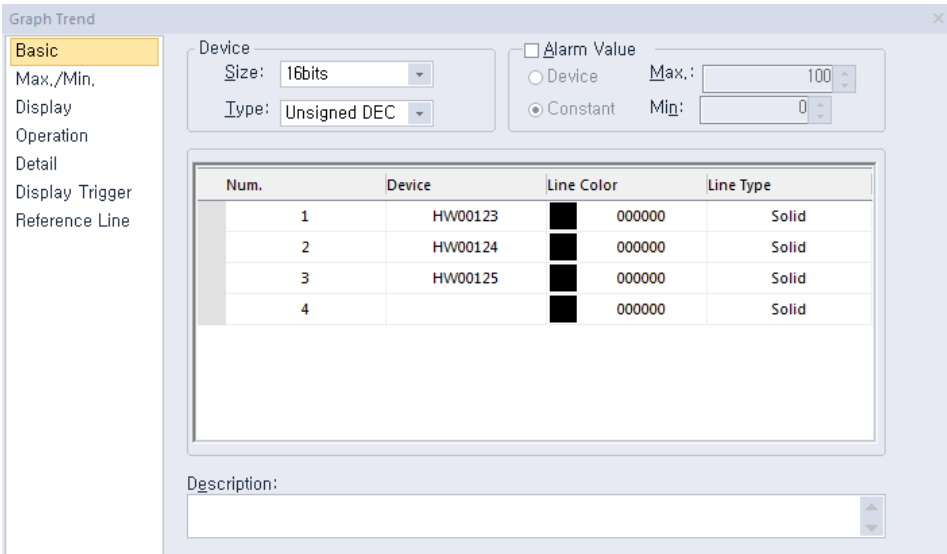

- **Device:** Specify the following options for the device.

Size	Set the data size of the device (16 bit or 32 bit).
Type	Set the data form of the device (signed decimal, unsigned decimal, BCD, or float).

Note

The data size, data form, maximum alarm value, minimum alarm value, maximum data value, minimum data value are equally applied to all the devices.



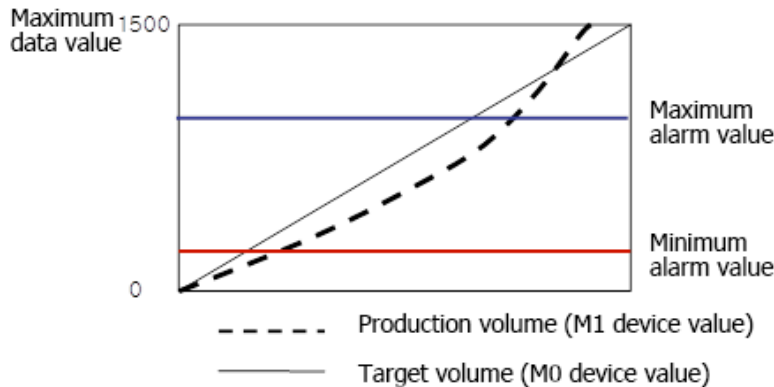

- **Alarm Value:** Set whether or not to trigger an alarm if the data value exceeds the maximum or minimum limits.

Device	Set the specified device value as the alarm limit.
Constant	Set the specified fixed value as the alarm limit.





As you see in the example below that compares the production volume and the target volume, the maximum alarm value and the minimum alarm value are displayed in straight lines.



- **Device:** Click to specify a device to be referenced by the object or enter the device address. When you specify a device, a new device input row will be created automatically, where you can specify more devices to be referenced (up to 8).

Num.	Device	Line Color	Line Type
1	HW00000	 000000	Solid
2	HW00002	 000000	Solid
3	HW00100	 000000	Solid
4		 000000	Solid

To remove a device, click the row number and press delete on the keypad.

Num.	Device	Line Color	Line Type
1	HW00000	 000000	Solid
2	HW00002	 000000	Solid
3	HW00100	 000000	Solid
4		 000000	Solid

- **Line Color:** Set the line color for the graph.
- **Line Type:** Set the line type (dash or solid).
- **Line Thickness:** Sets the line thickness.

Solid line	1 through 10 can be set.
dotted line	Only 1 is available.

- **Max/Min:** The Max/Min settings for the trend graph object include the following.

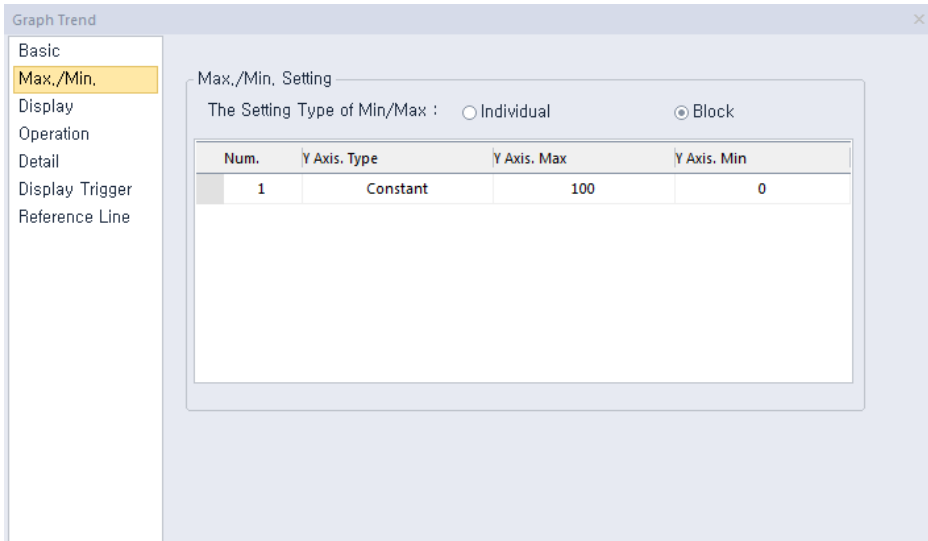

- **Max/Min Setting:** This option specifies the maximum and minimum values for the data to display. The maximum and minimum values are set by selecting with a device or by entering the constant values. In the graph below, the minimum value is set at 0 and the maximum value is set at 150 within a range of 0-150. If a device to be monitored has a value outside the maximum or minimum values, it is displayed as the maximum or minimum value on the graph.

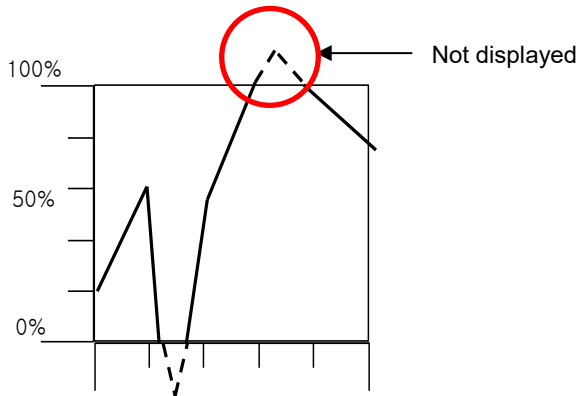

Individual

If the maximum and minimum values are set to [Individual], they are applied respectively based on the device address listed in [Basic]. If the devices P0000, P0001, and P0002 are registered in [Basic] as shown in the screenshot below, the maximum and minimum values are specified:

Num.	Device	Line Color	Line Type
1	P0000	000000	Solid
2	P0001	#0000	Solid
3	P0002	0000ff	Solid
4		000000	Solid

[Default Settings]

The Setting Type of Min/Max : Individual Block

Num.	Y Axis, Type	Y Axis, Max	Y Axis, Min
1	Constant	150	0
2	Constant	200	100
3	Constant	250	50

[Maximum/Minimum Value Settings]

When the maximum and minimum values are specified separately as shown above, both values for the first device, P0000, are set to 0 and 150 on the graph. The maximum and minimum values for the second device, P0001, are set to 100 and 200 on the graph. The maximum and minimum values for the third device, P0002, are set to 50 and 250 on the graph.

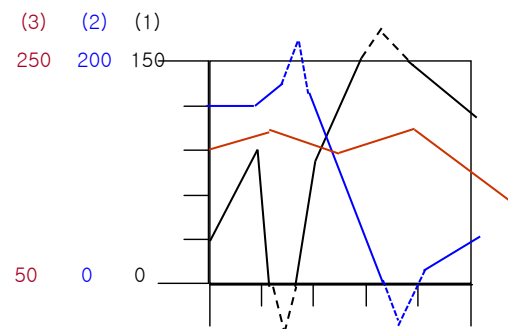
**Note**

If **The Setting Type of Min/Max** is set to [Individual], **Reference Line** menu option is not displayed.

Block

If the maximum and minimum values are set to [Block], all indices that are set in [Basic] will have the same values. Therefore, indices 1, 2, and 3 will all have the same maximum and minimum values in the example above. Only one maximum and minimum value each can be entered for whole setting configurations.

The reference line can be set only when the maximum and minimum values are specified.

- **Display:** The display settings for the trend graph object include the following.

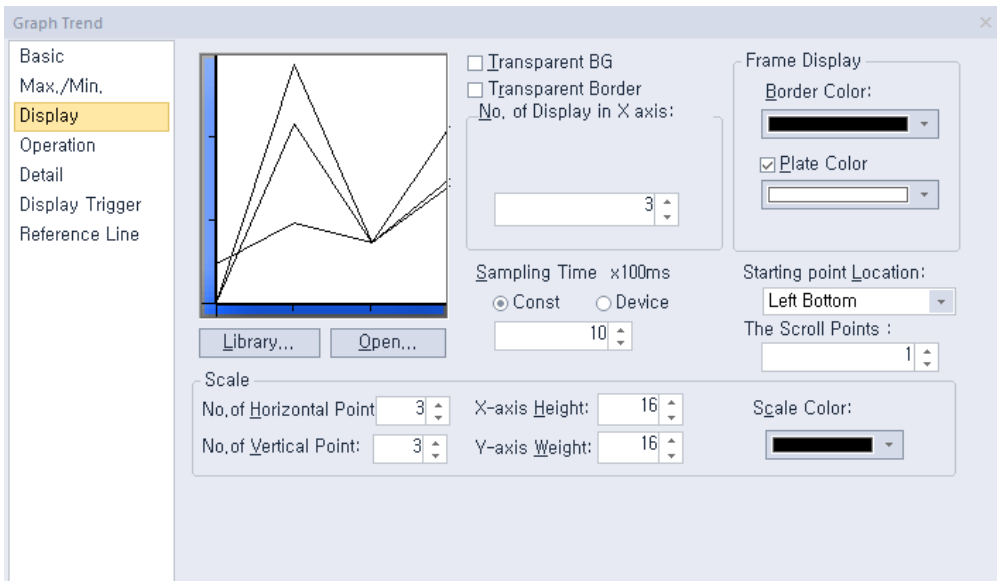

- **Library:** Click to select a background image for the graph from a library.
- **Open:** Click to locate background image for the graph on your computer.
- **Transparent BG:** Set whether or not to make the background of the graph transparent.
- **Transparent Border:** Set whether or not to use a transparent border.
- **No. of Display in X axis:** Set the number of data points to be displayed on the graph (more than 3).

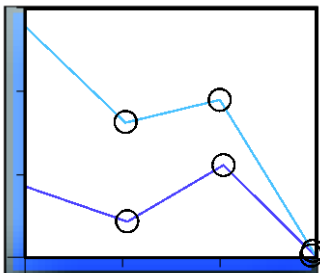

- **Frame Display:** Specify the following options for the frame.

Border Color	Set a border color.
Plate Color	Set the background for areas not filled by value ranges.

- **Sampling Time x100ms:** Set the cycle for collecting the data, in milliseconds

Constant	For a constant, the cycle can be set between 1 and 6,000.
Device	For a device, the cycle is set from a device value. However, if a device value is 0, the cycle is changed to 100 ms forcefully.

- **Starting Point Location:** Set a starting point for the scales (left bottom or right bottom).

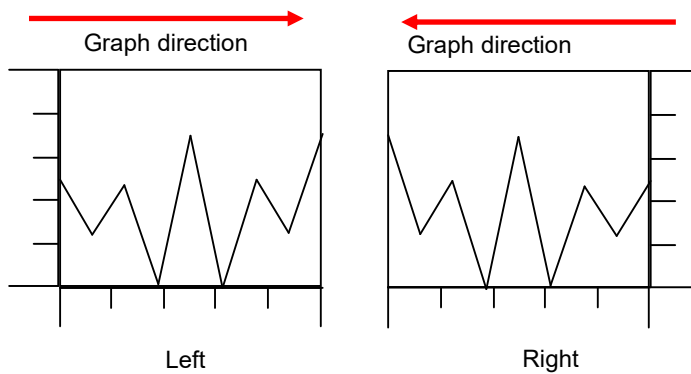

- **The Scroll Points:** Set the speed that the graph will scroll across the screen, by setting the number of points that the graph will scroll each time. The higher the number, the faster the graph will scroll. Previous data are deleted by the number of points that you set and the new data are displayed in the direction of the graph.
- **Scale:** Specify the following options for the scale.

No. of Horizontal Point	Set the number of points on the X axis.
No. of Vertical Point	Set the number of points on the Y axis.
X-axis Height	Set the height of the X axis scale.
Y-axis Width	Set the width of the Y axis scale.
Scale Color	Set the color of the scales.

- **Operation:** The operation settings for trend graph object include the following.

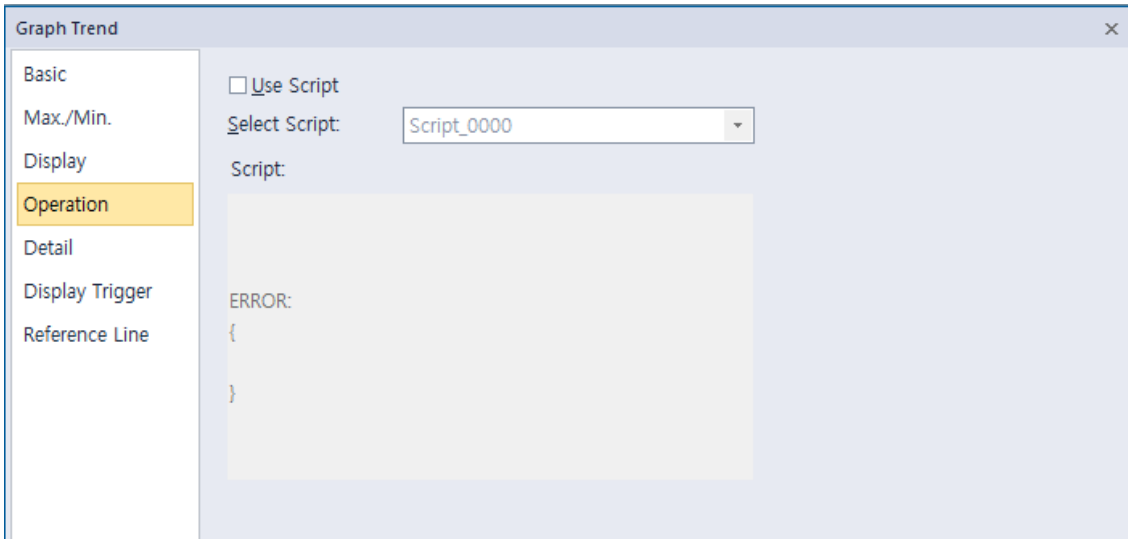

- **Use Script:** Click the checkbox to use a script with the object.

Select Script	Select a script from the drop-down list.
Script	When you select a script, it appears here. To modify a script, refer to <4.2 Scripts> .

- **Detail:** The detail settings for trend graph object include the following.

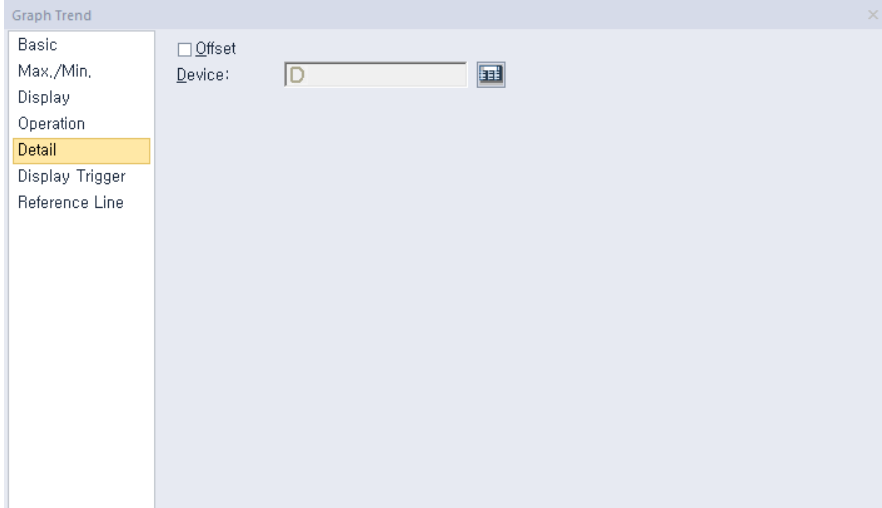

- **Offset:** Click the checkbox to use the offset function. You can offset the device address based on the value of the offset device. For example, if the starting device address is P100, XP-Builder reads the value from the offset device and offsets the address by that value. If the offset value is 10, for example, then the referenced device address is P110.
- **Device:** Enter a device or tag address directly into the input field or click the keypad icon to the right to specify a device or tag address. When you click the keypad icon to open the Device window, you can also specify network settings, if necessary.

- **Display Trigger:** The display trigger settings for the trend graph object include the following.

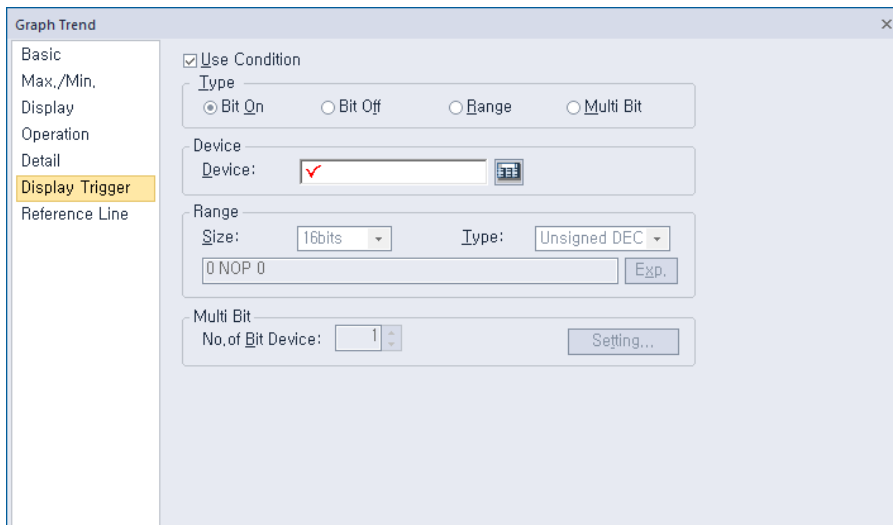

- **Use Condition:** Set whether or not to specify a condition for the action.
- **Type:** Set a type of condition to specify.

Bit On	The action is performed when the device is switched on.
Bit Off	The action is performed when the device is switched off.
Range	The action is performed when the value falls within the specified range.
Multi Bit	The action is performed when the logical operation result of multiple devices is met.

- **Device:** Enter a device or tag address directly into the input field or click the keypad icon to the right to specify a device or tag address. When you click the keypad icon to open the Device window, you can also specify network settings, if necessary.
- **Range:** If you select the range condition, specify the range.

Size	16 bit or 32 bit.
Type	Signed decimal, unsigned decimal, BCD, or float.
Exp.	Click to designate the expression as conditional.

- **Multi Bit:** If you select the multi bit condition, specify the number of bits and click [Setting] to specify the bit conditions.

- **Reference Line:** The reference settings for the trend graph object include the following.

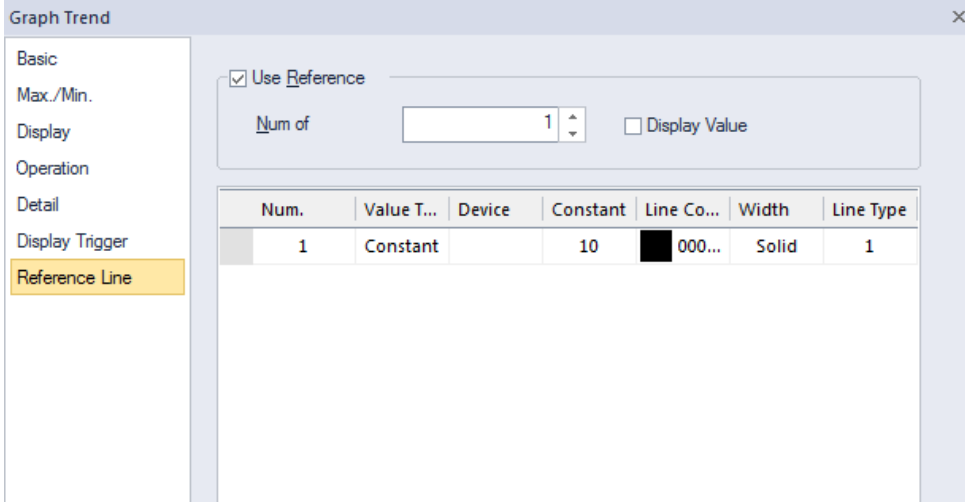

Note

In the **Max/Min** setting window, if **The Setting Type of Min/Max** is set to [Individual], **Reference Line** menu option is not displayed.

- **Use Reference:** Click the checkbox to use a reference line for the graph. A reference line refers to a line displaying the location of a specific value set by the user other than the maximum or minimum value.

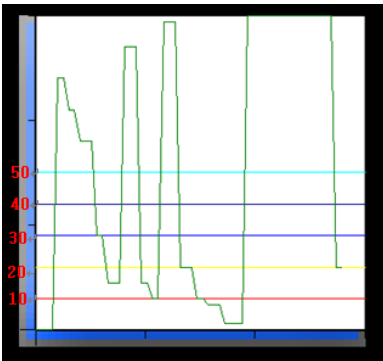

A reference line can be set as a fixed value or device value and it can be set only when the maximum and minimum values are set to [Block].

Num of Reference	Set the number of reference lines. When you enter the number of lines and move to the properties table of the reference lines, the corresponding number rows will be created to allow you adjust the properties. 1 to 8 reference lines can be created.
Reference Properties	You can set the properties only when Use Reference is checked. If the Value Type is set to Constant, you cannot enter a device. If the Value Type is set to Device, you cannot enter a fixed value. The number column is a reference line number. It cannot be edited and its location cannot be changed. If the line type of a reference line is set to Dash, the thickness can only be set to 1.

Display Value

Select this option to display reference line values in a text. The text color is the same as the color of the reference line, and the text size is adjusted based on the size of the trend graph.

4.3.8.6 Logging Trend Graph

The following sections describe available options for logging trend graph objects.

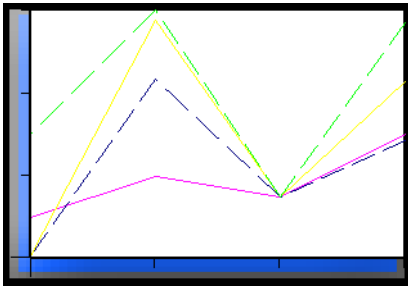
**Note**

- Only the data points on the X axis (time axis) that are collected most recently according to the current time will be displayed on the screen.

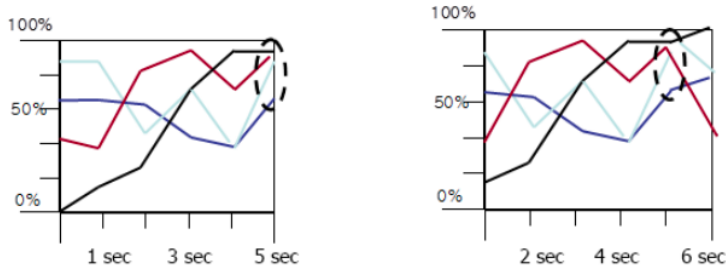

- When the logging is in progress, communication may stop for a short time because of environmental factors such as noise and the logging fails. The data of such time are not normal and are not displayed on the logging trend graph. Therefore, the graph appears intermittently.

- **Basic:** The basic settings for the logging trend graph object include the following.

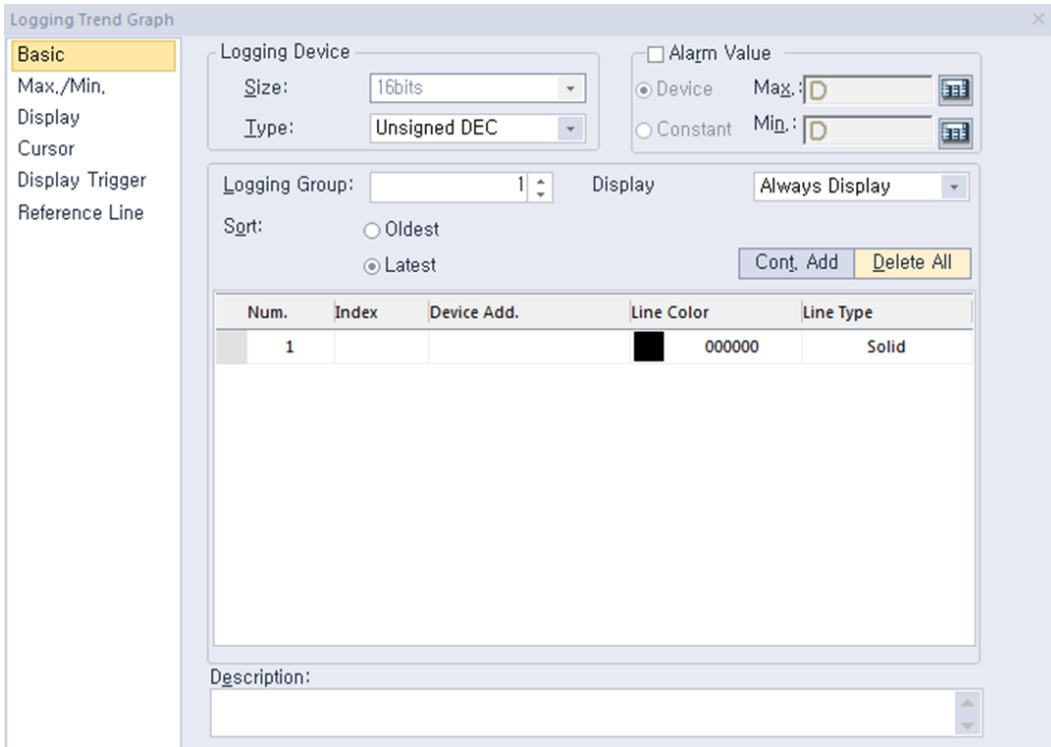

- **Logging Device:** Specify the following options for the logging device.

Size	Set the data size of the device (16 bit or 32 bit). You can change the data size only in the Logging data from the project pane.
Type	Set the data form of the device (signed decimal, unsigned decimal, BCD, or float).

- **Alarm Value:** Set whether or not to trigger an alarm if the data value exceeds the maximum or minimum limits.

Device	Set the specified device value as the alarm limit.
Constant	Set the specified fixed value as the alarm limit.

As you see in the example below that compares the production volume and the target volume, the maximum alarm value and the minimum alarm value are displayed in straight lines.

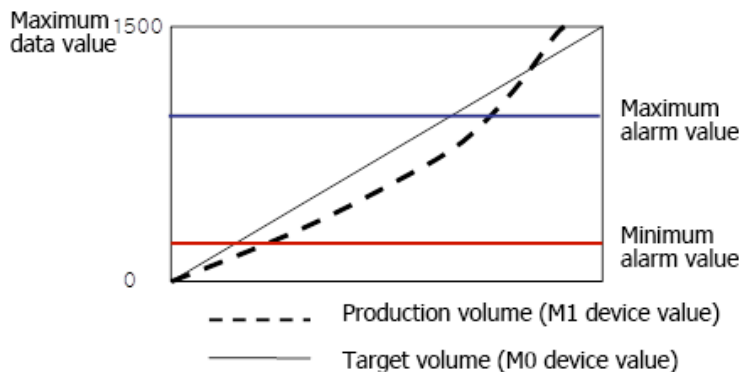

- **Logging Group:** Set the number of the logging group, which is set in the Logging.

No	Condition	Repeat Count	Repeat Period	Device	Device Count
1	Bit Device P00100 Rising Edge	100	0D 00:00:10	P0100	1
2	Every hour at 39m	1	0D 00:00:10		1
3	Once at 2013Y 4M 8D 00:39	30	0D 00:00:10		1

- **Display:** Set the condition for displaying the graph.

Always Display	Set to display always.
Display when Bit On/Off	Set to display only specific index based on the device value. For example, if the conditional device is set to P0100 and four indices are set as shown in the screenshot below,

Num.	Index	Device Add.	Line Color	Line Type
1	1	P0100	0000ff	Dash
2	3	P0102	ff00ff	Solid
3	5	P0104	00ffff	Dash
4	6	P0105	ffff00	Solid

The following graphs are displayed based on the status of the four contiguous bit devices starting from P0100.

P0100	P0102	P0104	P0105
ON	OFF	OFF	OFF
ON	ON	ON	OFF
OFF	OFF	ON	ON



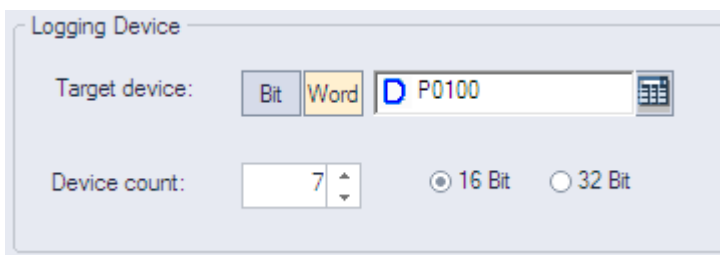

- **Sort:** Set a sort option (oldest first or latest first).
- **Cont. Add:** Click to enter a starting index and range. Up to 20 items can be entered.
- **Delete All:** Click to delete all input data at once.
- **Index:** Shows the index number of the device. An index number increases by 1 starting from 1 of logging device as the device address increases.

As you see in the example below, when 32 devices from P0100 are edited to be logged, the indices numbers of the four devices, P0001, P0005, P0010, and P0018, from the 32 devices are as follow.







Device address	Logging index
P0001 (logging device)	1
P0002	2
...	...
P0005	5
...	...
P0010	10
...	...
P0018	18



To add a new item, enter the index number for the item on the index column. When a new item is added, a blank index column is created on the next row to add a next item. Up to 20 items can be added.

Num.	Index	Device Add.	Line Color	Line Type
1	20	P0019	 c0c0c0	Solid
2	10	P0009	 ff0000	Solid
3	3	P0002	 000080	Solid
4			 000000	Solid

To remove an item, click the row number and press delete on the keypad.

Num.	Index	Device Add.	Line Color	Line Type
1	20	P0019	 c0c0c0	Solid
2	10	P0009	 ff0000	Solid
3	3	P0002	 000080	Solid
4			 000000	Solid



Num.	Index	Device Add.	Line Color	Line Type
1	20	P0019	 c0c0c0	Solid
2	3	P0002	 000080	Solid
3			 000000	Solid

- **Device Add.:** Shows the starting address for the logging group and logging index. The device address cannot be input and is displayed according to the logging index.
- **Line Color:** Set the line color for the graph.
- **Line Type:** Set the line type (dash or solid).
- **Line Thickness:** Sets the line thickness.

Solid line	1 through 10 can be set.
-------------------	--------------------------

dotted line Only 1 is available.

- **Description:** Enter a description for the object.

• **Max/Min:** The Max/Min settings for the trend graph object include the following.

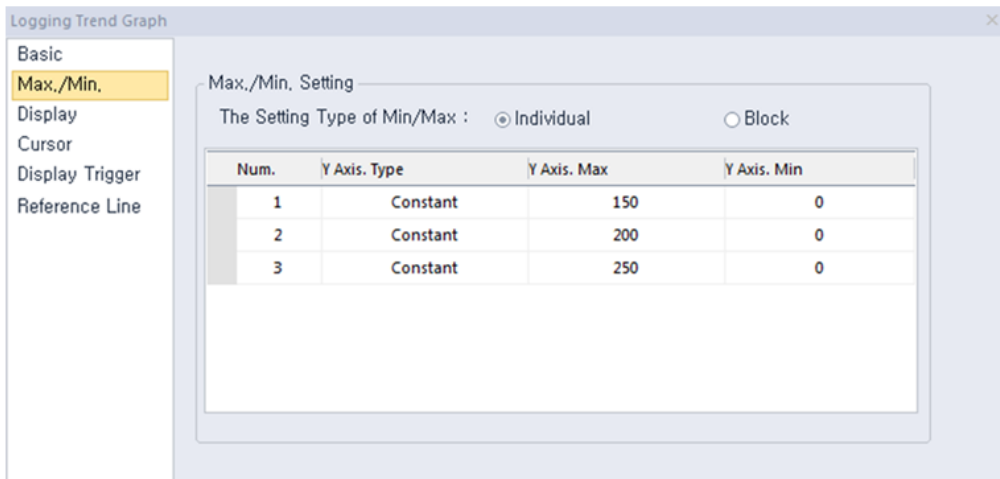

- **Max/Min Setting:** This option specifies the maximum and minimum values for the data to display. The maximum and minimum values are set by selecting with a device or by entering the constant values. In the graph below, the minimum value is set at 0 and the maximum value is set at 150 within a range of 0-150. If a device to be monitored has a value outside the maximum or minimum values, it is displayed as the maximum or minimum value on the graph.

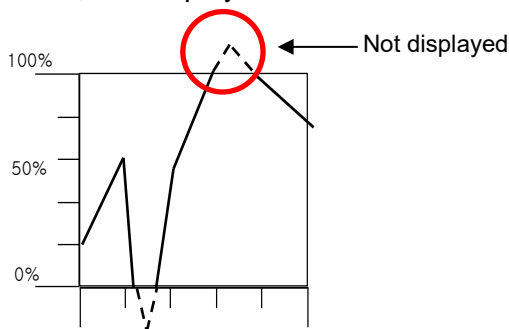

Individual

If the maximum and minimum values are set to [Individual], they are applied respectively based on the device address listed in [Basic]. If the devices P0000, P0001, and P0002 are registered in [Basic] as shown in the screenshot below, the maximum and minimum values are specified:

Num.	Device	Line Color	Line Type
1	P0000	000000	Solid
2	P0001	#0000	Solid
3	P0002	0000ff	Solid
4		000000	Solid

[Default Settings]

The Setting Type of Min/Max : Individual Block

Num.	Y Axis, Type	Y Axis, Max	Y Axis, Min
1	Constant	150	0
2	Constant	200	100
3	Constant	250	50

[Maximum/Minimum Value Settings]

When the maximum and minimum values are specified separately as shown above, both values for the first device, P0000, are set to 0 and 150 on the graph. The maximum and minimum values for the second device, P0001, are set to 100 and 200 on the graph. The maximum and minimum values for the third device, P0002, are set to 50 and 250 on the graph.

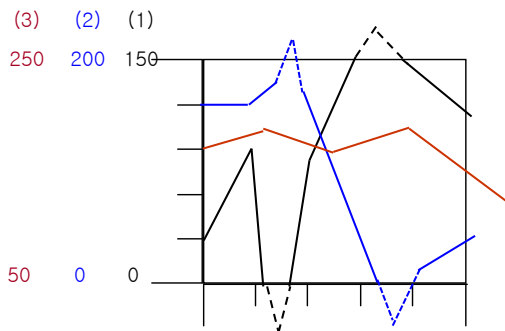

Note

If The Setting Type of Min/Max is set to [Individual], Reference Line menu option is not displayed.

Block

If the maximum minimum values are set to [Block], all indices that are set in [Default] will have the same values. Therefore, indices 1, 2, and 3 will all have the same maximum and minimum values in the example above. Only one maximum and minimum value each can be entered for whole setting configurations. The reference line can be set only when the maximum and minimum values are specified.

- **Display:** The display settings for the logging trend graph object include the following.

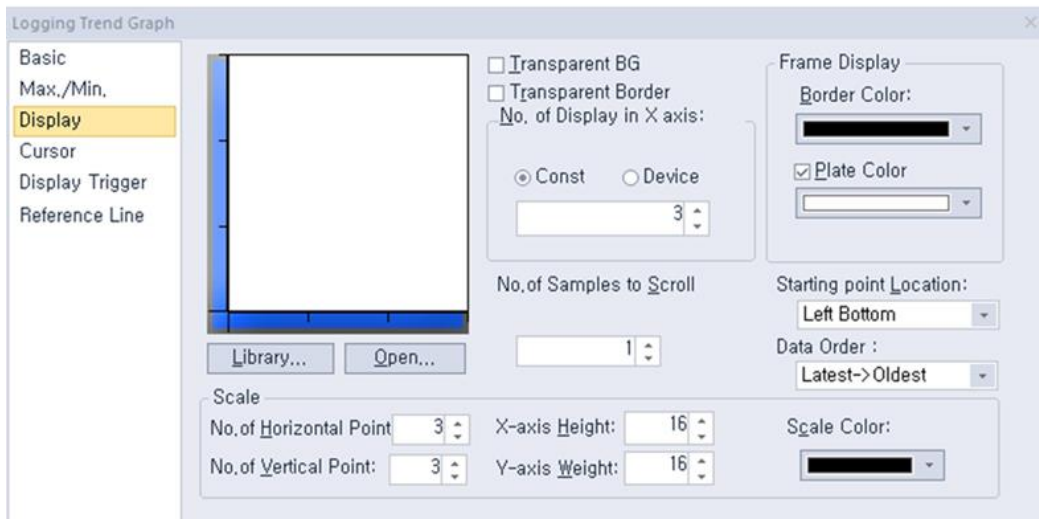

- **Library:** Click to select a background image for the graph from a library.
- **Open:** Click to locate background image for the graph on your computer.
- **Transparent BG:** Set whether or not to make the background of the graph transparent.
- **Transparent Border:** Set whether or not to use a transparent border.
- **No. of Display in X axis:** Set the number of data points to be displayed on the graph (3 to 120).

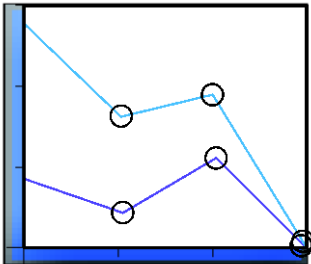

Device	Set the specified device value as the X axis point.
---------------	---

Constant	Set the specified fixed value as the X axis point.
-----------------	--

- **Frame Display:** Specify the following options for the frame.

Border Color	Set a border color.
---------------------	---------------------

Plate Color	Set the background for areas not filled by value ranges.
--------------------	--

- **No. of Samples to Scroll:** A user can refer to the data of his intended position with the special switch; Previous Data/Next Data View. However, in the below two cases (The latest data tracking mode/the oldest data tracking mode), a window is automatically updated and it displays the data since the present time. Through this option, you can set how many data units will be applied to transfer a screen.

The latest data tracking mode	When you edit and download logging trend graph after setting Preferred View Mode as the latest data tracking mode, logging trend is set as the latest data tracking mode and it updates a screen every time logging is performed newly and then, it tracks and shows the latest logging data.
--------------------------------------	---

The oldest data	The logging type linked to logging trend graph is set as
------------------------	--

tracking mode	circular buffer, the data displayed at the current screen will be removed someday with continuous logging process. Then, the equipment updates a screen automatically and displays the oldest data.
----------------------	---

- **Starting Point Location:** Set a starting point for the scales (Left Bottom, Right Bottom, Left Top, or Right Top).
- **Data Order:** Specify the following options for the data order, for example:

Time	Data
8: 10	10
8: 20	20
8: 30	30
8: 40	40
8: 50	50

Latest -> Oldest

Show data in order from most recent to oldest. The starting point is on the left:

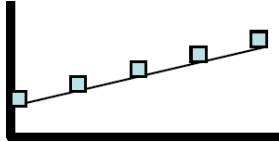

The Starting Point Location is on the right:

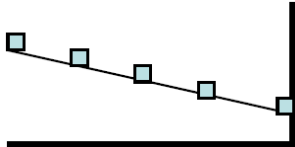

Oldest -> Latest

Show data in order from oldest to most recent. The Starting Point Location is on the left:

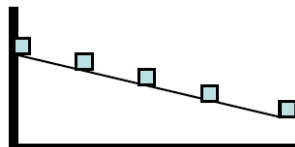

The Starting Point Location is on the right:

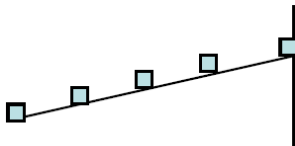

- **Scale:** Specify the following options for the scale.

No. of Horizontal Point	Set the number of points on the X axis.
No. of Vertical Point	Set the number of points on the Y axis.
X-axis Height	Set the height of the X axis scale.

Y-axis Width	Set the width of the Y axis scale.
Scale Color	Set the color of the scales.

- **Cursor:** The cursor settings for logging trend graph object include the following.

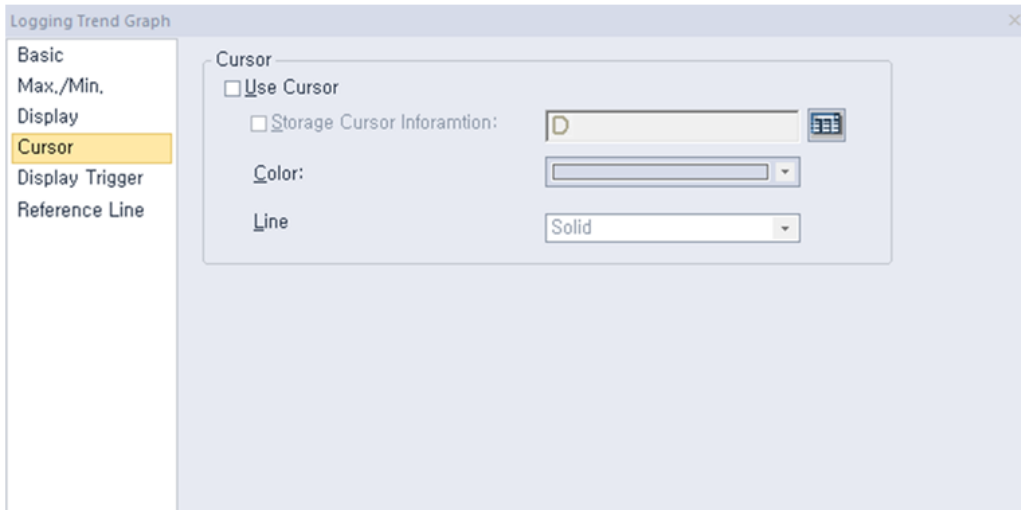

- **Cursor:** Specify the following options for the cursor.

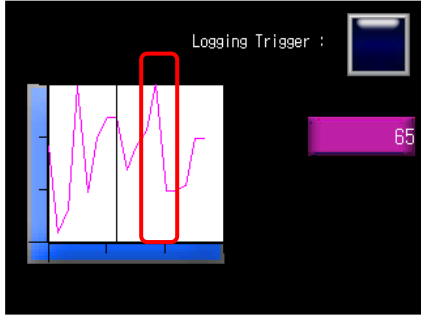
<p>Use Cursor</p>	<p>Set whether or not to display the cursor on the XGT screen, as illustrated below.</p> 
<p>Storage Cursor Information</p>	<p>Set whether or not to save cursor data (logging time of the current cursor position and related values). Cursor data is saved at device and the size of the device is always 32 bit. The cursor information is saved as follows, based on the device set:</p> <p style="text-align: right;"><Logging device size: 16bit></p>

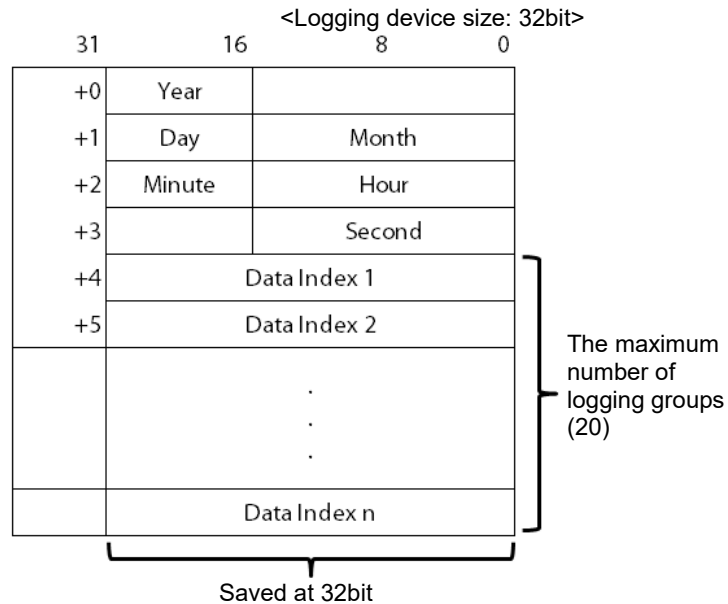
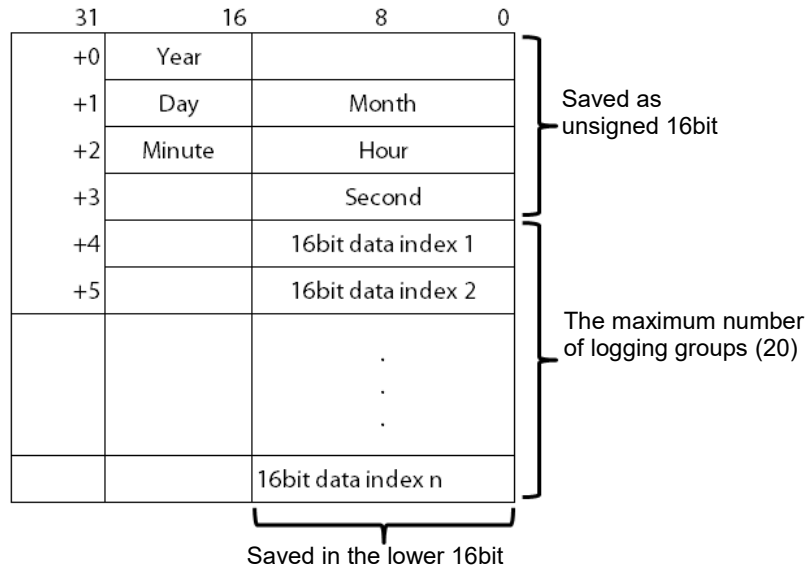

The cursor information is saved in the specified device whenever the data from the current location of the cursor is changed or the cursor is moved.

Color	Set a color for the cursor.
Line	Set a line type for the cursor (solid or dash).

- Note**
- To show or hide the cursor, click the Logging Trend Graph area.
 - The location of the cursor is at the center of the current data.

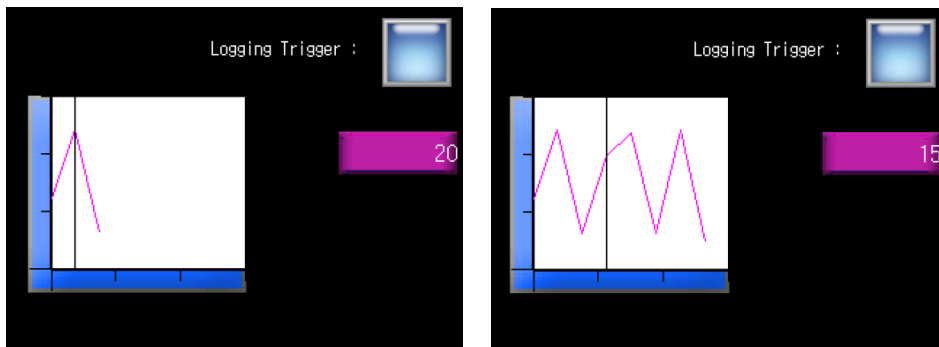

< The current data value: 3>

< The current data value: 8>

- If the data to be displayed is deleted, because the area is deleted in the cursor display mode, the cursor will also disappear. When the logging is restarted, the cursor will reappear.
- The cursor cannot be moved. To move the cursor, use the Next Log Trend Data or Previous Log Trend Data option from the Special Switch object.
- If there is no data before or after the current data, the cursor is moved to the previous or next data.

- **Display Trigger:** The display trigger settings for the logging trend graph object include the following.

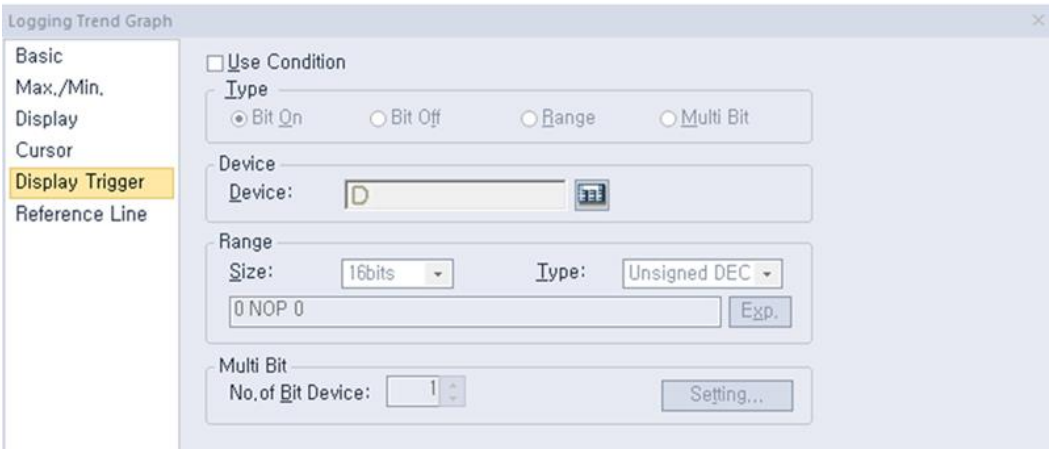

- **Use Condition:** Set whether or not to specify a condition for the action.
- **Type:** Set a type of condition to specify.

Bit On	The action is performed when the device is switched on.
Bit Off	The action is performed when the device is switched off.
Range	The action is performed when the value falls within the specified range.
Multi Bit	The action is performed when the logical operation result of multiple devices is met.

- **Device:** Enter a device or tag address directly into the input field or click the keypad icon to the right to specify a device or tag address. When you click the keypad icon to open the Device window, you can also specify network settings, if necessary.
- **Range:** If you select the range condition, specify the range.

Size	16 bit or 32 bit.
Type	Signed decimal, unsigned decimal, BCD, or float.
Exp.	Click to designate the expression as conditional.

- **Multi Bit:** If you select the multi bit condition, specify the number of bits and click [Setting] to specify the bit conditions.

- **Reference Line:** The reference line settings for the logging trend graph object include the following.

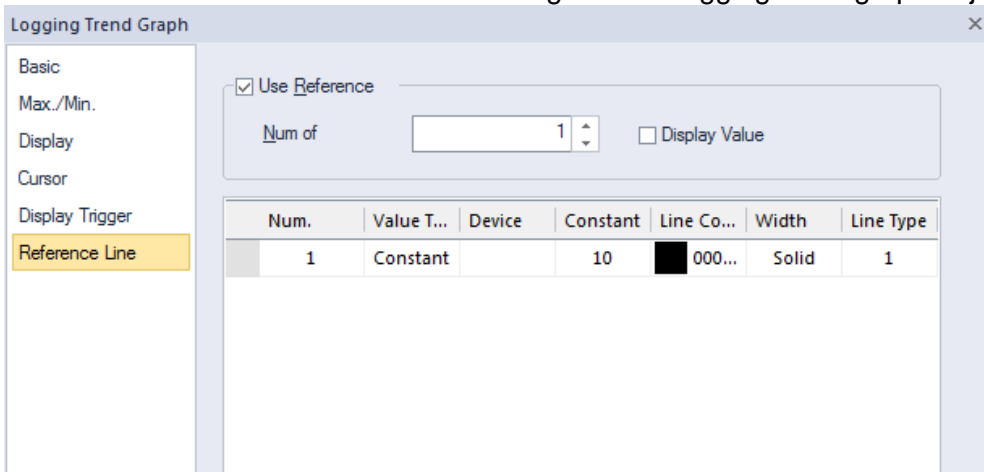

Note

In the **Max/Min** setting window, if **The Setting Type of Min/Max** is set to [Individual], **Reference Line** menu option is not displayed.

- **Use Reference:** Click the checkbox to use a reference line for the graph. A reference line refers to a line displaying the location of a specific value set by the user other than the maximum or minimum value.

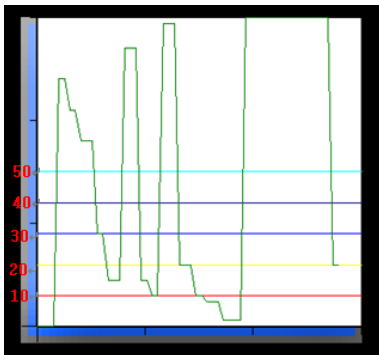

A reference line can be set as a fixed value or device value and it can be set only when the maximum and minimum values are set to [Block].

Num of Reference

Set the number of reference lines. When you enter the number of lines and move to the properties table of the reference lines, the corresponding number rows will be created to allow you adjust the properties. 1 to 8 reference lines can be created.

Reference Properties

You can set the properties only when Use Reference is checked. If the Value Type is set to Constant, you cannot enter a device. If the Value Type is set to Device, you cannot enter a fixed value. The number column is a reference line number. It cannot be edited and its location cannot be changed. If the line type of a reference line is set to Dash, the thickness can only be set to 1.

Display Value	Select this option to display reference line values in a text. The text color is the same as the color of the reference line, and the text size is adjusted based on the size of the logging trend graph.
----------------------	---

4.3.8.7 Scatter Graph – Logging Scatter

The following sections describe available options for logging scatter graph objects. When the **Scatter Graph Type** window appears, select **Logging Scatter** and click **OK**.

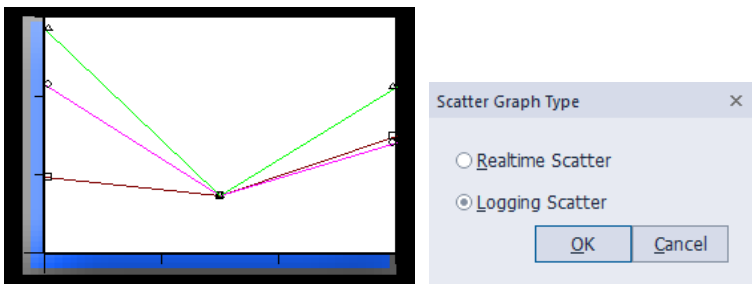

- **Basic:** The basic settings for the logging scatter graph objects include the following.

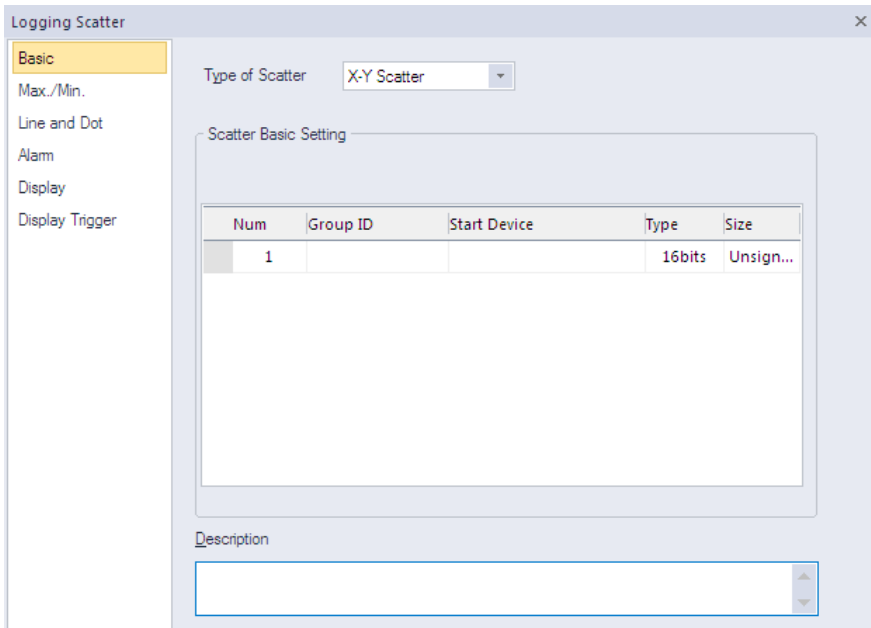

- **Type of Scatter:** Set the type of scatter chart.

Y Scatter	Shows device addresses, including the logging start device, in order along the X-axis. The data displays in a loop, so you do not need to designate the minimum or maximum value.
------------------	---

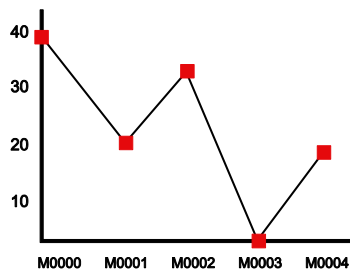
**X-Y Scatter**

For two continuous device addresses from starting device, shows the previous device value along the X-axis and the next device value along the Y-axis and displays dot or value where the two coordinates intersect. You must designate a minimum and maximum value for the axes.

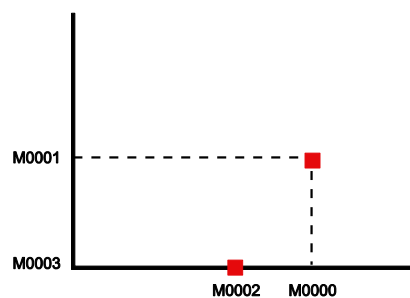

- **Scatter Basic Setting:** Specify the following options for the scatter chart.

Group ID	The logging group No. to be displayed can be established among 1~32. You can fix the logging group number from Logging in the Project pane. To add a new item to logging scatter chart, input logging group number to logging group window and press the Enter key. If a new item is added, the screen for logging group number is added to the next row and you can also add another item up to 20. To delete the item, select the number of item and press the Delete key.
Start Device	It displays a starting device that is applicable to input logging group number. Register the start device from the Logging in the Project pane. Each control device data is initialized as 0 after completing each operation.
Type	It sets the data type of device.
Size	It displays the size of device to be logged. The value established at logging of common data is applied to the size of logging device and you cannot set it up.

- **Description:** Enter a description for the object.

- **Max./Min.:** The maximum and minimum value settings for the logging scatter graph object include the following.

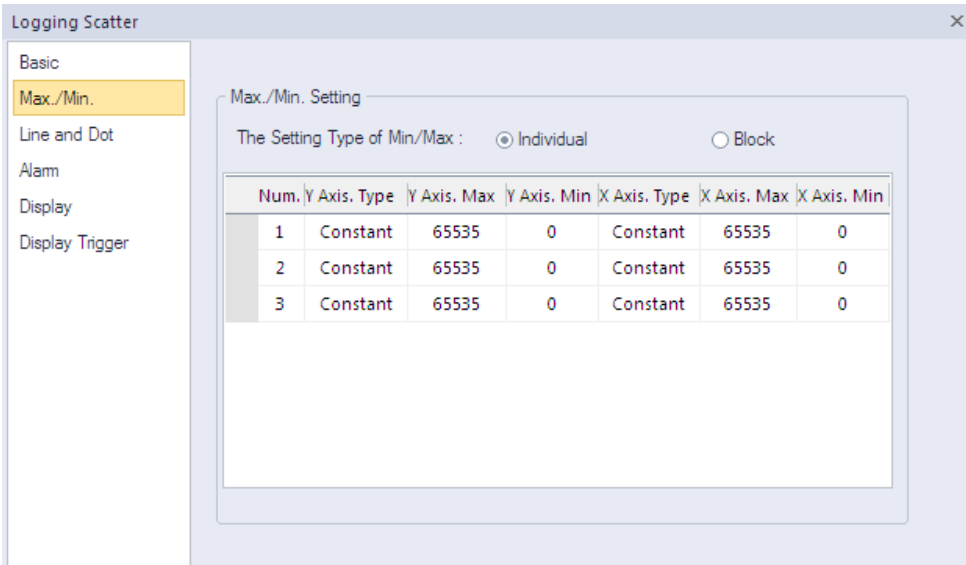

- **Max./Min. Setting:** Specify the following options for the maximum/minimum setting.

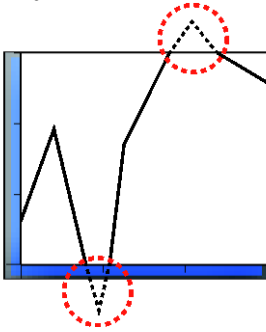
<p>Y Axis Type / X Axis Type</p>	<p>You can set the minimum and maximum value as many as the items of logging distribution charts added at Basic Settings. Namely, you cannot add or delete the items on the minimum and maximum value. The type of the minimum and maximum value can be established as Constant or Device.</p>
<p>Y Axis. Max / Y Axis. Min</p>	<p>You can set the minimum and maximum values of data to be displayed on the Y-axis. You can use a device value or a constant. If the device value exceeds the minimum or maximum, it is displayed as the minimum or maximum value of the graph.</p> 
<p>X Axis. Max / X Axis. Min</p>	<p>You can set the minimum and maximum values of data to be displayed on the X-axis. You can use a device value or a constant. If the device value exceeds the minimum or maximum value, it is displayed as the minimum or maximum value of the graph. The X-axis displays the device values in order, so you do not need to designate a minimum or maximum value.</p>

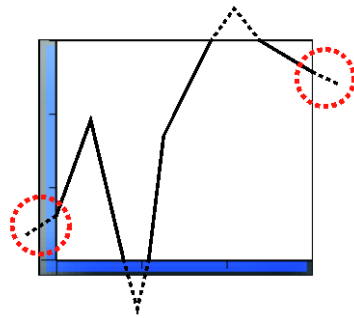

Note

If The **Setting Type of Min/Max** is set to [Individual], **Reference Line** menu option is not displayed.

- **Line and Dot:** The line and dot settings for the logging scatter graph object include the following.

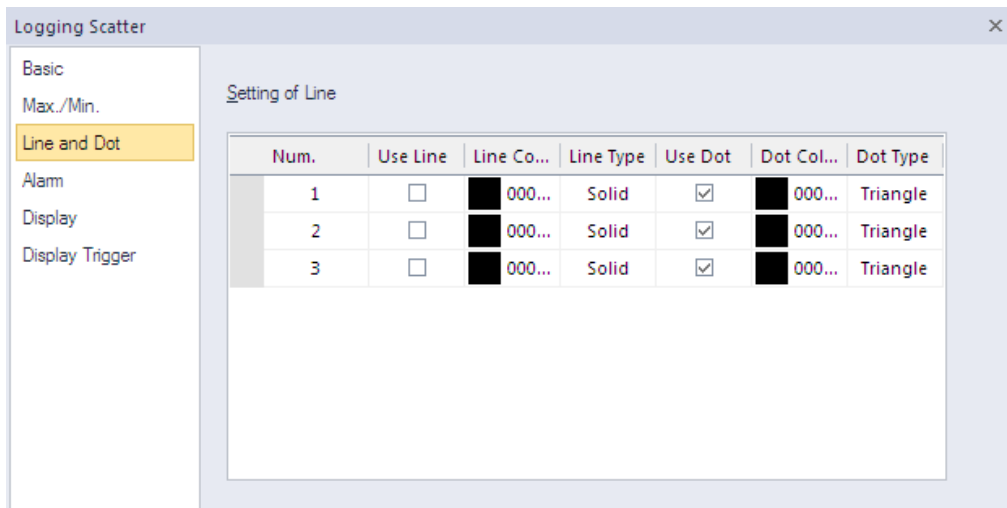

- **Setting of Line:** Specify the following options for the line.

Use Line	Set to use a line to display the data.
Line Color	Set the color of the line.
Line Type	Set the type of the line (solid or dash).
Use Dot	Set to use dots for displaying the data.
Dot Color	Set the color of the dots.
Dot Type	Set the type of the dots.

- **Alarm:** The alarm settings for the logging scatter graph object include the following.

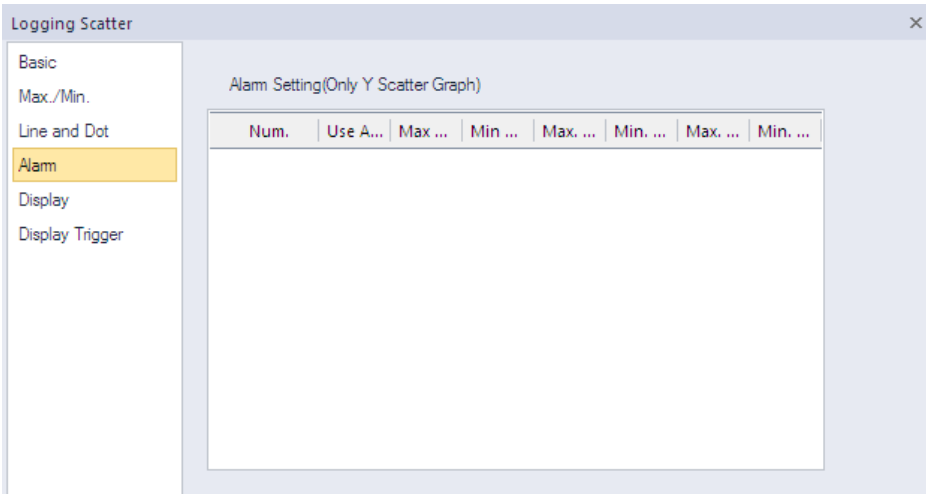

- **Alarm Setting (Only Y Scatter Graph):** Specify the following options for the alarm.

Use Alarm	Set whether to use a value or not. It is only available for the Y Scatter graph.
Max Value / Min Value	It establishes a warning upper bound and warning lower bound for a logging trend graph. If the device value is more than the warning upper bound, it is not shown as the established line or dot color but displayed as the upper bound line or dot color. However, if the device value is less than the lower bound, it is displayed as the established lower bound line or dot color.
Max Line / Min Line	You can set the color of a line to be applied when it is more or less than the warning upper bound of a logging distribution graph. If the device value exceeds the warning upper bound, it is displayed as upper bound line color. However, if it is less than the warning upper bound, it is displayed as the lower bound line color.
Max. Dot / Min. Dot	You can set the color of a dot to be applied when it is more or less than the warning upper bound of a logging distribution graph. If the device value exceeds the warning upper bound, it is displayed as the upper bound dot color. However, if it is less than the warning upper bound, it is displayed as the lower bound dot color.

- **Display:** The display settings for the logging scatter graph objects are shown in the below screenshot.

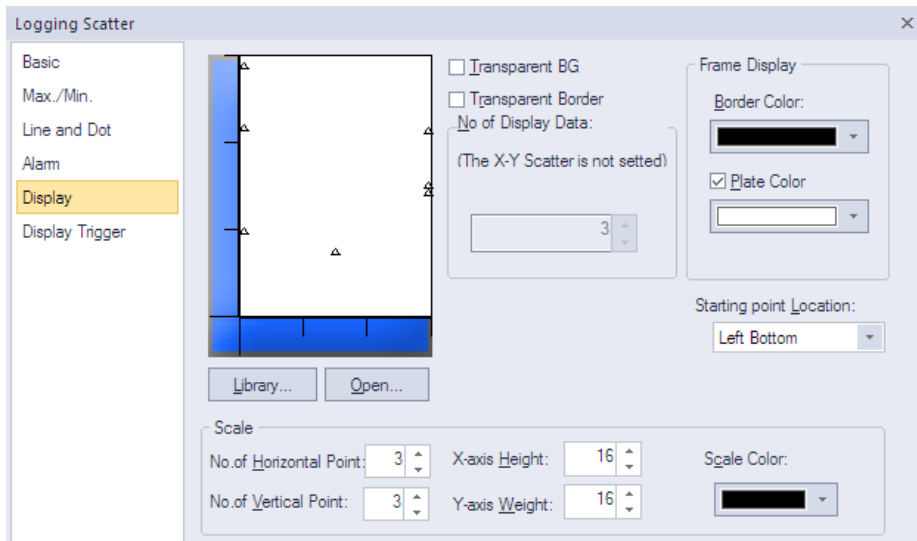

- **Library:** Click to select a background image for the graph from an image library.
- **Open:** Click to search for a background image for the graph on your computer.
- **Transparent BG:** Set whether or not to make the background of the graph transparent.
- **Transparent Border:** Set whether or not to use a transparent border.
- **No. of Display Data:** It fixes the number of dots to be displayed on a screen.
X-Y Scatter indicates a dot as two device values.
Y Scatter indicates each device value with a dot.
- **Frame Display:** Specify the following options for the frame.

Border Color	Select a border color.
Plate Color	Select the background for areas not filled by value ranges.

- **Starting Point Location:** Set a starting point for the scales (left bottom or right bottom).
- **Scale:** Specify the following options for the scale.

No. of Horizontal Point	Set the number of points on the X axis.
No. of Vertical Point	Set the number of points on the Y axis.
X-axis Height	Set the height of the X axis scale.
Y-axis Width	Set the width of the Y axis scale.
Scale Color	Set the color of the scales.

Note

- The logging scatter graph is to mainly show how data are distributed and once data are displayed on the screen, they will not be deleted. The logging type linked to logging scatter graph is set as circular buffer, the data displayed at the current screen will be removed someday with continuous logging process. In this case, the dots and lines corresponding to the deleted data will not be deleted.
- The dots and lines distributed on the screen are initialized when the logging area is deleted. That is, you can use the logging area deleting device to initialize the scatter screen.
- If you use multiple logging groups by connecting them, a short delay may occur in displaying data of each group. Each logging group operates independently with its own execution condition, monitoring device, and monitoring area. Therefore, a time difference occurs between collected data when executing even if execution conditions of multiple logging groups are met at the same time. Also, a short time delay occurs between displayed data by each group on the data distribution.
- The logging function communicates with priority on the device connected to the previous object when acquiring data. Therefore, lots of logging groups and shorter acquisition cycles highly affect the overall communication speed. It is recommended to use the logging function when necessary.

- **Display Trigger:** The display trigger settings for logging scatter objects are shown in the below screenshot.

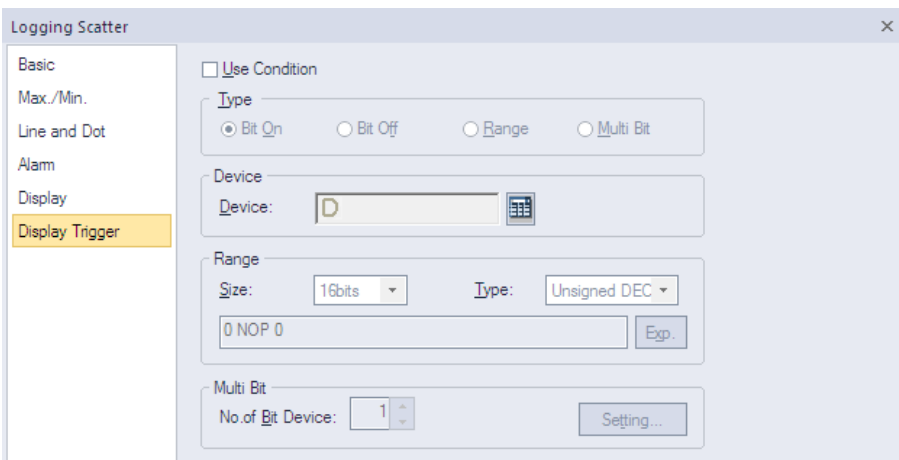

- **Use Condition:** Set whether or not to specify a condition for the action.
- **Type:** Set a type of condition to specify.

Bit On	The action is performed when the device is switched on.
Bit Off	The action is performed when the device is switched off.
Range	The action is performed when the value falls within the specified range.
Multi Bit	The action is performed when the logical operation result of multiple devices is met.

- **Device:** Enter a device or tag address directly into the input field or click the keypad icon to the right to specify a device or tag address. When you click the keypad icon to open the Device window, you can also specify network settings, if necessary.
- **Range:** If you select the range condition, specify the range.

Size	16 bit or 32 bit.
Type	Signed decimal, unsigned decimal, BCD, or float.
Exp.	Click to designate the expression as conditional.

- **Multi Bit:** If you select the multi bit condition, specify the number of bits and click [Setting] to specify the bit conditions.

- **Reference Line:** The reference line settings for the logging trend graph object include the following.

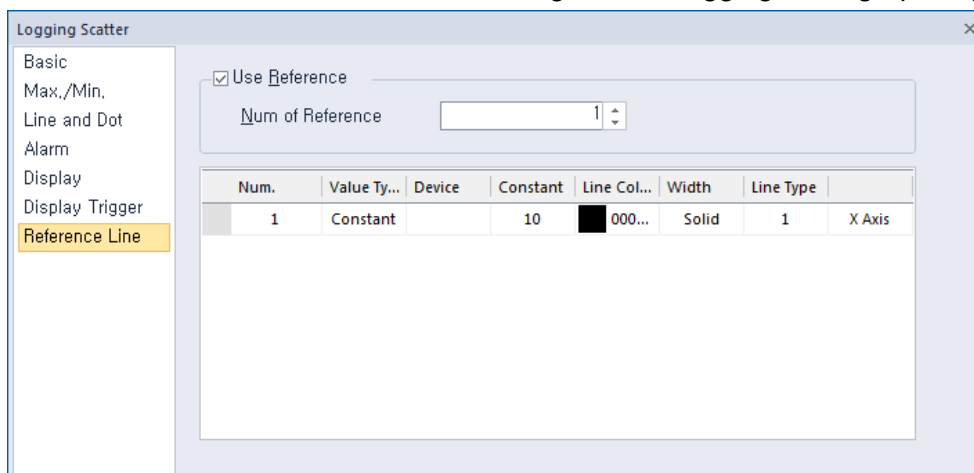

Note

In the **Max/Min** setting window, if **The Setting Type of Min/Max** is set to [Individual], **Reference Line** menu option is not displayed.

- **Use Reference:** Click the checkbox to use a reference line for the graph. A reference line refers to a line displaying the location of a specific value set by the user other than the maximum or minimum value.

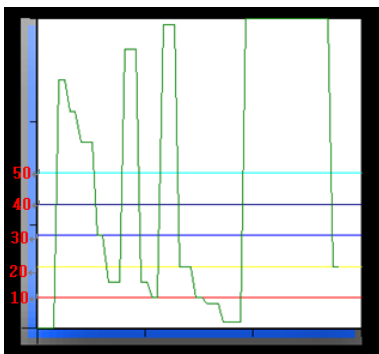

A reference line can be set as a fixed value or device value and it can be set only when the maximum and minimum values are set to [Block].

Num of Reference	Set the number of reference lines. When you enter the number of lines and move to the properties table of the reference lines, the corresponding number rows will be
-------------------------	--

	created to allow you adjust the properties. 1 to 8 reference lines can be created.
Reference Properties	You can set the properties only when Use Reference is checked. If the Value Type is set to Constant, you cannot enter a device. If the Value Type is set to Device, you cannot enter a fixed value. The number column is a reference line number. It cannot be edited and its location cannot be changed. If the line type of a reference line is set to Dash, the thickness can only be set to 1.

4.3.8.8 Scatter Graph - Realtime Scatter

The following sections describe available options for realtime scatter objects.

When the **Scatter Graph Type** window appears, select **Realtime Scatter** and click **OK**.

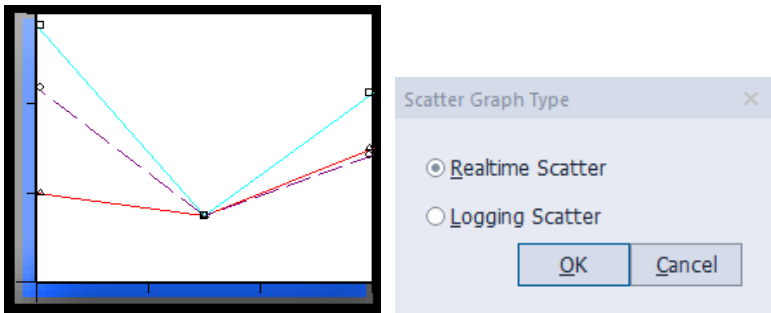

- **Basic:** The basic settings for the realtime scatter graph object include the following.

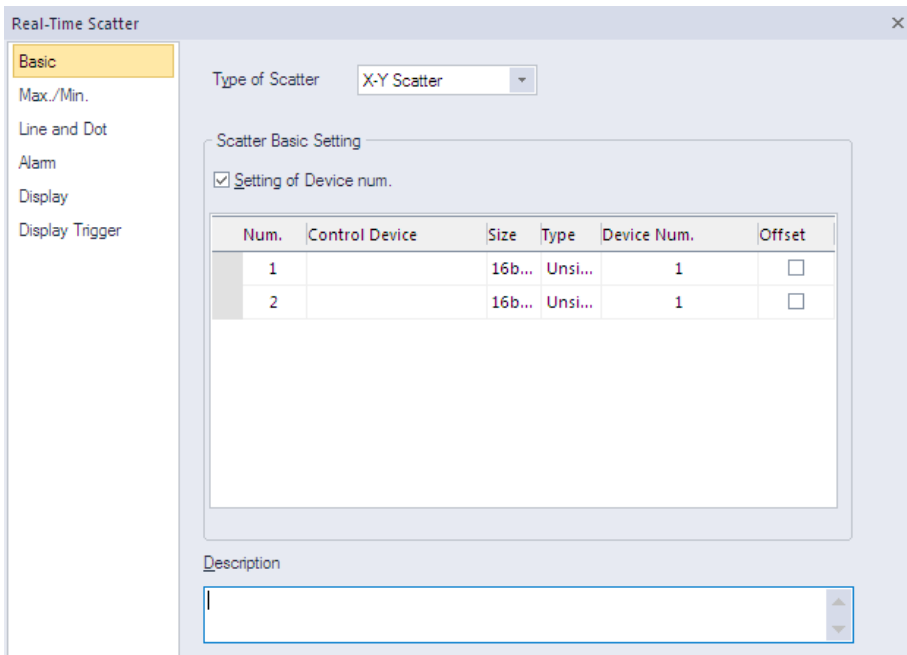

- **Type of Scatter:** Set the type of scatter chart.

Y Scatter

Shows device addresses, including the logging start device, in order along the X-axis. The data displays in a loop, so you do not need to designate the minimum or maximum value.

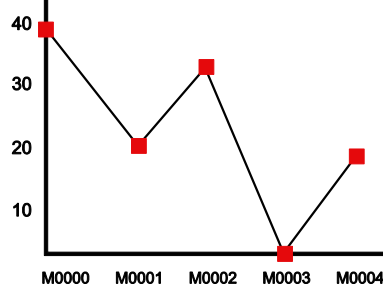

X-Y Scatter

For two continuous device addresses from starting device, shows the previous device value along the X-axis and the next device value along the Y-axis and displays dot or value where the two coordinates intersect. You must designate a minimum and maximum value for the axes.

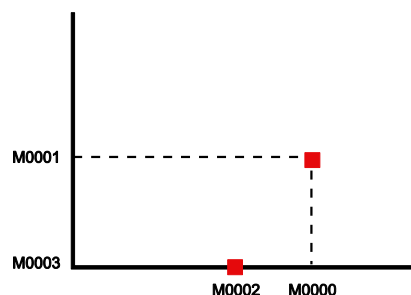

- **Scatter Basic Setting:** Specify the following options for the scatter.

<p>Setting of Device num.</p>	<p>Set the number of devices to be monitored (1 to 1,000). You can specify device numbers individually or designate a control device to specify device addresses. The example below shows when you specify a device number individually.</p> <table border="1" data-bbox="459 454 1225 667"> <thead> <tr> <th>Num.</th> <th>Control Device</th> <th>Size</th> <th>Type</th> <th>Device Num.</th> <th>Offset</th> </tr> </thead> <tbody> <tr> <td>1</td> <td>P0000</td> <td>16bits</td> <td>Unsi...</td> <td>100</td> <td><input type="checkbox"/></td> </tr> <tr> <td>2</td> <td>P0003</td> <td>16bits</td> <td>Unsi...</td> <td>80</td> <td><input type="checkbox"/></td> </tr> <tr> <td>3</td> <td>P0005</td> <td>16bits</td> <td>Unsi...</td> <td>50</td> <td><input type="checkbox"/></td> </tr> <tr> <td>4</td> <td></td> <td>16bits</td> <td>Unsi...</td> <td>1</td> <td><input type="checkbox"/></td> </tr> </tbody> </table> <p>When you do not specify a device number, the device address, control device +1, is set as the device number.</p> <table border="1" data-bbox="459 734 1236 947"> <thead> <tr> <th>Num.</th> <th>Control Device</th> <th>Size</th> <th>Type</th> <th>Device Num.</th> <th>Offset</th> </tr> </thead> <tbody> <tr> <td>1</td> <td>P0000</td> <td>16bits</td> <td>Unsi...</td> <td>Control Device+1</td> <td><input type="checkbox"/></td> </tr> <tr> <td>2</td> <td>P0003</td> <td>16bits</td> <td>Unsi...</td> <td>Control Device+1</td> <td><input type="checkbox"/></td> </tr> <tr> <td>3</td> <td>P0005</td> <td>16bits</td> <td>Unsi...</td> <td>Control Device+1</td> <td><input type="checkbox"/></td> </tr> <tr> <td>4</td> <td></td> <td>16bits</td> <td>Unsi...</td> <td>Control Device+1</td> <td><input type="checkbox"/></td> </tr> </tbody> </table>	Num.	Control Device	Size	Type	Device Num.	Offset	1	P0000	16bits	Unsi...	100	<input type="checkbox"/>	2	P0003	16bits	Unsi...	80	<input type="checkbox"/>	3	P0005	16bits	Unsi...	50	<input type="checkbox"/>	4		16bits	Unsi...	1	<input type="checkbox"/>	Num.	Control Device	Size	Type	Device Num.	Offset	1	P0000	16bits	Unsi...	Control Device+1	<input type="checkbox"/>	2	P0003	16bits	Unsi...	Control Device+1	<input type="checkbox"/>	3	P0005	16bits	Unsi...	Control Device+1	<input type="checkbox"/>	4		16bits	Unsi...	Control Device+1	<input type="checkbox"/>
Num.	Control Device	Size	Type	Device Num.	Offset																																																								
1	P0000	16bits	Unsi...	100	<input type="checkbox"/>																																																								
2	P0003	16bits	Unsi...	80	<input type="checkbox"/>																																																								
3	P0005	16bits	Unsi...	50	<input type="checkbox"/>																																																								
4		16bits	Unsi...	1	<input type="checkbox"/>																																																								
Num.	Control Device	Size	Type	Device Num.	Offset																																																								
1	P0000	16bits	Unsi...	Control Device+1	<input type="checkbox"/>																																																								
2	P0003	16bits	Unsi...	Control Device+1	<input type="checkbox"/>																																																								
3	P0005	16bits	Unsi...	Control Device+1	<input type="checkbox"/>																																																								
4		16bits	Unsi...	Control Device+1	<input type="checkbox"/>																																																								
<p>Control Device</p>	<p>If the first bit of word control device is On, it displays the number of continuous devices from a starting device at a graph. If the second bit is On, it removes the current graph area. Each control device data is initialized into 0 after completing each operation. If a new item is added, the blank control device window is created to next row and you can add another item up to 8.</p>																																																												
<p>Size</p>	<p>Set the data size of the object.</p>																																																												
<p>Type</p>	<p>Set the data type of the object.</p>																																																												
<p>Device Num.</p>	<p>Set the device number.</p>																																																												
<p>Offset</p>	<p>Set whether to use the offset.</p> <ul style="list-style-type: none"> - In case of not using offset <div data-bbox="459 1440 1289 1680" style="border: 1px solid gray; padding: 5px;"> <p>Scatter Basic Setting</p> <p><input checked="" type="checkbox"/> Setting of Device num.</p> <table border="1"> <thead> <tr> <th>Num.</th> <th>Control Device</th> <th>Size</th> <th>Type</th> <th>Device Num.</th> <th>Offset</th> </tr> </thead> <tbody> <tr> <td>1</td> <td>HW00000</td> <td>16bits</td> <td>Unsig...</td> <td>10</td> <td><input type="checkbox"/></td> </tr> <tr> <td>2</td> <td></td> <td>16bits</td> <td>Unsig...</td> <td>1</td> <td><input type="checkbox"/></td> </tr> </tbody> </table> </div> <table border="1" data-bbox="523 1686 1289 2007"> <thead> <tr> <th colspan="3">In case of not using offset</th> </tr> <tr> <th>Address</th> <th>Description</th> <th>Display</th> </tr> </thead> <tbody> <tr> <td>HW00000</td> <td>Control Device</td> <td>-</td> </tr> <tr> <td>HW00001</td> <td>Reserved</td> <td>-</td> </tr> <tr> <td>HW00002</td> <td>Start Device</td> <td>Display</td> </tr> <tr> <td>-</td> <td>...(10)</td> <td>Display</td> </tr> </tbody> </table>	Num.	Control Device	Size	Type	Device Num.	Offset	1	HW00000	16bits	Unsig...	10	<input type="checkbox"/>	2		16bits	Unsig...	1	<input type="checkbox"/>	In case of not using offset			Address	Description	Display	HW00000	Control Device	-	HW00001	Reserved	-	HW00002	Start Device	Display	-	...(10)	Display																								
Num.	Control Device	Size	Type	Device Num.	Offset																																																								
1	HW00000	16bits	Unsig...	10	<input type="checkbox"/>																																																								
2		16bits	Unsig...	1	<input type="checkbox"/>																																																								
In case of not using offset																																																													
Address	Description	Display																																																											
HW00000	Control Device	-																																																											
HW00001	Reserved	-																																																											
HW00002	Start Device	Display																																																											
-	...(10)	Display																																																											

HW00011	Device number of start device	Display
---------	-------------------------------	---------

- In case of using offset

Scatter Basic Setting

Setting of Device num.

Num.	Control Device	Size	Type	Device Num.	Offset
▶ 1	HW00000	16bits	Unsig...	10	<input checked="" type="checkbox"/>
2		16bits	Unsig...	1	<input type="checkbox"/>

When using offset, the device (HW00002) is used as the offset device as shown below. If the value of HW00002 is 5, 10 consecutively from HW00007 separated by 5words from HW00002 are displayed.

In case of using offset		
Address	Description	Display
HW00000	Control Device	-
HW00001	Reserved	-
HW00002	Used as the offset value (if value is 5)	Not display
-	...(Start from the offset distance)	-
HW00007	Start Device	Display

- Remarks

If the size is 32bit, it is calculated as much as DWORD.

Scatter Basic Setting

Setting of Device num.

Num.	Control Device	Size	Type	Device Num.	Offset
1	HW00000	32bits	Unsig...	10	<input checked="" type="checkbox"/>

In case of not using offset		
Address	Description	Display
HW00000	Control Device	-
HW00001~HW00002	Reserved	-
HW00003	Start Device	Display
-	...(10)	Display
HW00022	Device number of start device	Display

Description Enter a description for the object.

- **Max./Min.:** The maximum and minimum value settings for the realtime scatter graph object include the following.

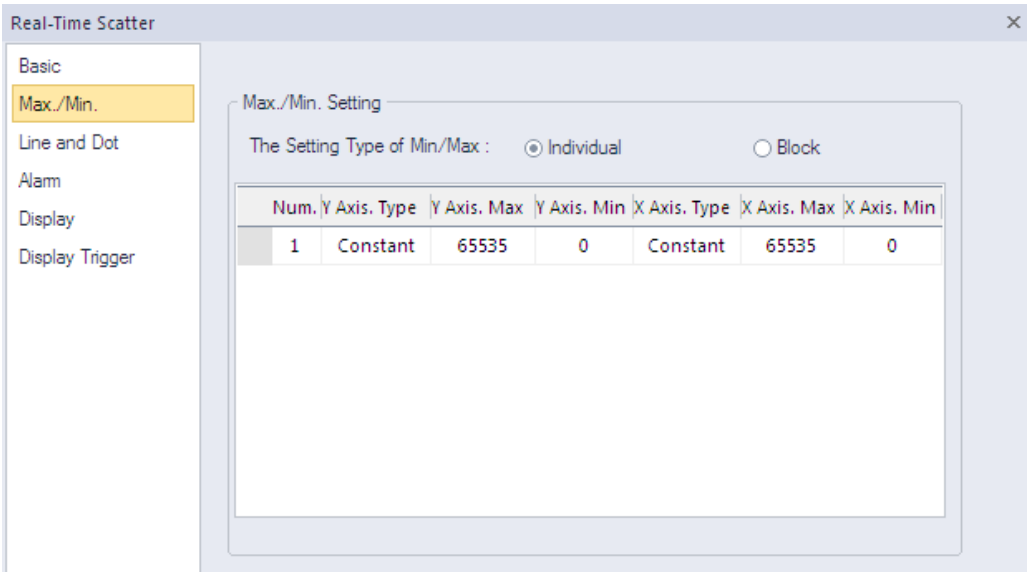

- **Max./Min. Setting:** Specify the following options for the maximum/minimum setting.

Y Axis Type / X Axis Type	You can set the minimum and maximum value as many as the items of logging distribution charts added at Basic Settings. Namely, you cannot add or delete the items on the minimum and maximum value. The type of the minimum and maximum value can be established as Constant or Device.
Y Axis. Max / Y Axis. Min	You can set the minimum and maximum values of data to be displayed on the Y-axis. You can use a device value or a constant. If the device value exceeds the minimum or maximum, it is displayed as the minimum or maximum value of the graph.
	You can set the minimum and maximum values of data to be displayed on the X-axis. You can use a device value or a constant. If the device value exceeds the minimum or maximum value, it is displayed as the minimum or maximum value of the graph. The X-axis displays the device values in order, so you do not need to designate a minimum or maximum value.

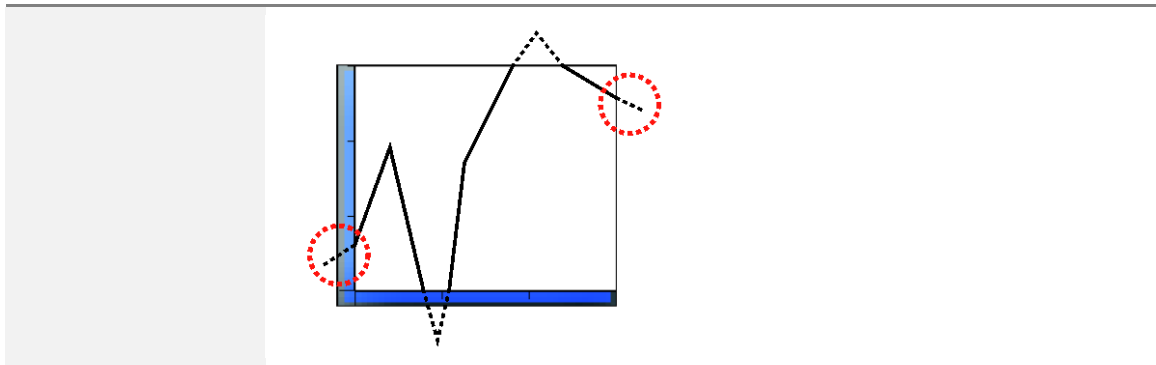

Note

If The **Setting Type of Min/Max** is set to [Individual], **Reference Line** menu option is not displayed.

- **Line and Dot:** The line and dot settings for the realtime scatter graph object include the following.

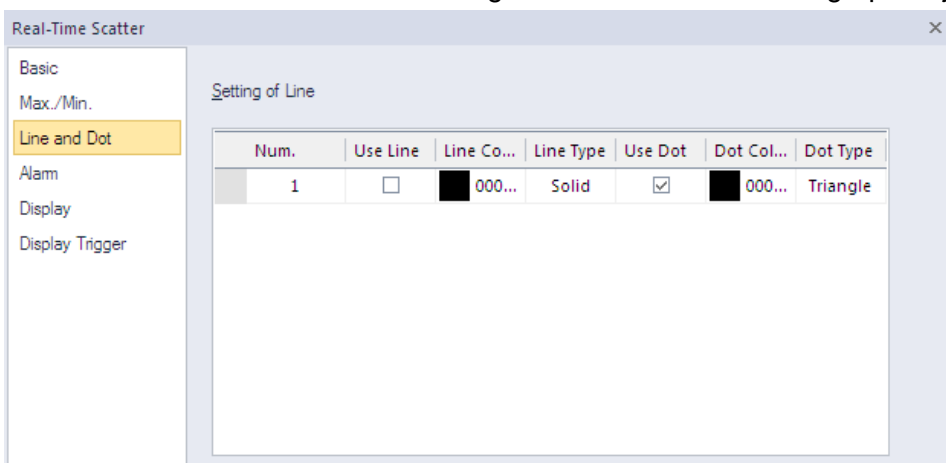

- **Setting of Line:** Specify the following options for the line.

Use Line	Set to use a line to display the data.
Line Color	Set the color of the line.
Line Type	Set the type of the line (solid or dash).
Use Dot	Set to use dots for displaying the data.
Dot Color	Set the color of the dots.
Dot Type	Set the type of the dots.

- **Alarm:** The alarm settings for the realtime scatter graph object include the following.

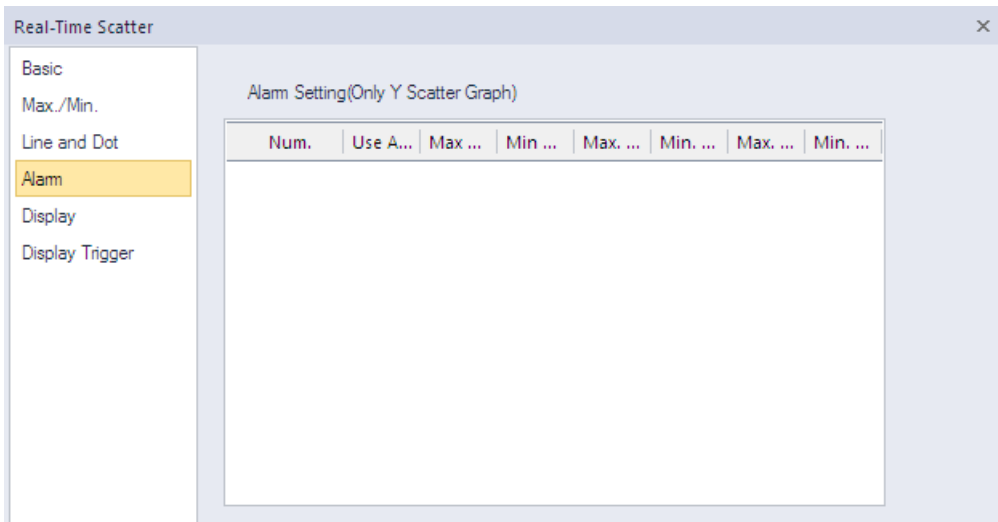

– **Alarm Setting (Only Y Scatter Graph):** Specify the following options for the alarm.

Use Alarm	Set whether using warning value or not. It is only available for the Y Scatter graph.
Max Value / Min Value	It establishes warning upper bound and warning lower bound for logging trend graph. If the device value is more than warning upper bound, it is not shown as established line or dot color but displayed as upper bound line or dot color. On the other hand, if the device value is less than lower bound, it is displayed as established lower bound line or dot color.
Max Line / Min Line	You can set the color of a line to be applied when it is more or less than the warning upper bound of logging distribution graph. If the device value exceeds warning upper bound, it is displayed as upper bound line color. On the other hand, if it is less than warning upper bound, it is displayed as lower bound line color.
Max. Dot / Min. Dot	You can set the color of a dot to be applied when it is more or less than the warning upper bound of logging distribution graph. If the device value exceeds warning upper bound, it is displayed as upper bound dot color. On the other hand, if it is less than warning upper bound, it is displayed as lower bound dot color.

- **Display:** The display settings for the realtime scatter graph object include the following.

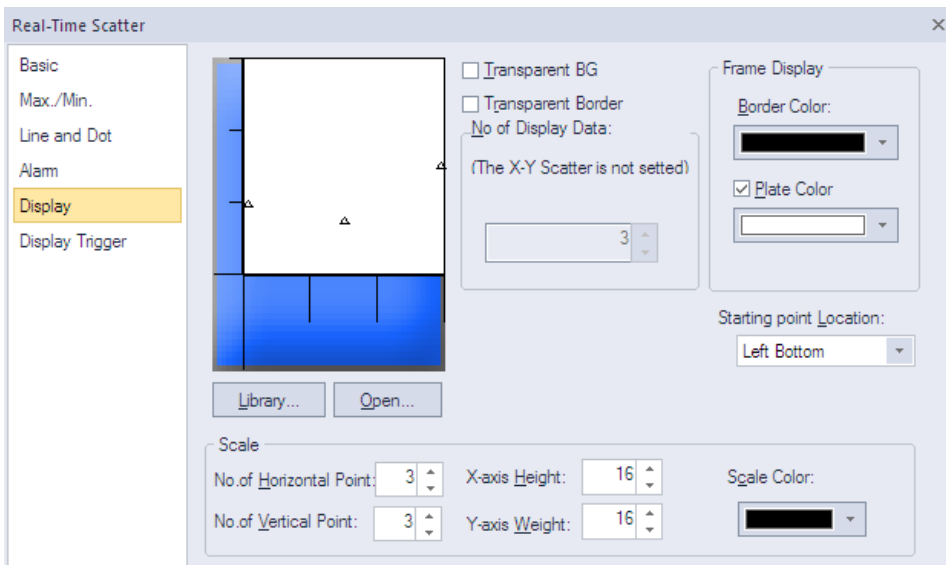

- **Library:** Click to select a background image for the graph from a library.
- **Open:** Click to locate background image for the graph on your computer.
- **Transparent BG:** Set whether or not to make the background of the graph transparent.
- **Transparent Border:** Set whether or not to use a transparent border.
- **No of Display data:** It fixes the number of dots to be displayed at a screen. If Type of Scatter is set to X-Y Scatter in the Basic settings, the number of dots cannot be set and up to 500 dots can be displayed.
X-Y Scatter indicates a dot as two device values.
Y Scatter indicates respectively each device value with a dot.
- **Frame Display:** Specify the following options for the frame.

Border Color	Set a border color.
Plate Color	Set the background for areas not filled by value ranges.

- **Starting Point Location:** Set a starting point for the scales (Left Bottom or Right Bottom).
- **Scale:** Specify the following options for the scale.

No. of Horizontal Point	Set the number of points on the X axis.
No. of Vertical Point	Set the number of points on the Y axis.
X-axis Height	Set the height of the X axis scale.
Y-axis Width	Set the width of the Y axis scale.
Scale Color	Set the color of the scales.

- **Display Trigger:** The display trigger settings for realtime scatter objects are shown in the below screenshot.

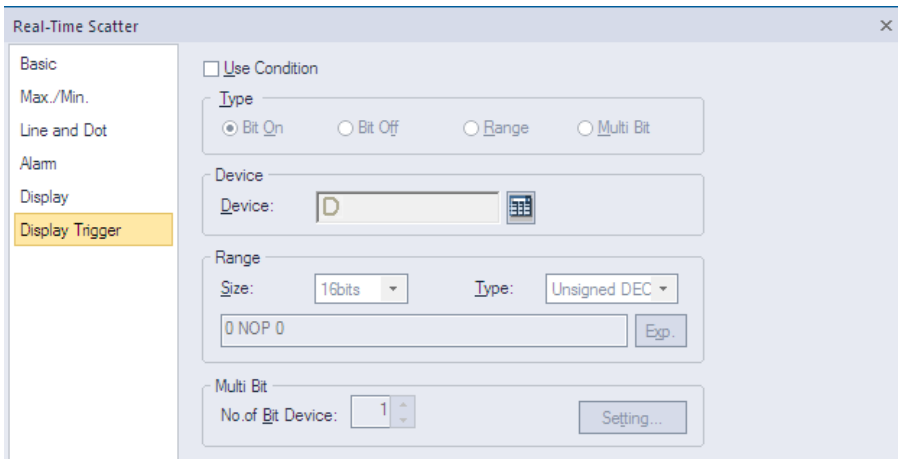

- **Use Condition:** Set whether or not to specify a condition for the action.
- **Type:** Set a type of condition to specify.

Bit On	The action is performed when the device is switched on.
Bit Off	The action is performed when the device is switched off.
Range	The action is performed when the value falls within the specified range.
Multi Bit	The action is performed when the logical operation result of multiple devices is met.

- **Device:** Enter a device or tag address directly into the input field or click the keypad icon to the right to specify a device or tag address. When you click the keypad icon to open the Device window, you can also specify network settings, if necessary.
- **Range:** If you select the range condition, specify the range.

Size	16 bit or 32 bit.
Type	Signed decimal, unsigned decimal, BCD, or float.
Exp.	Click to designate the expression as conditional.

- **Multi Bit:** If you select the multi bit condition, specify the number of bits and click [Setting] to specify the bit conditions.

- **Reference Line:** The reference line settings for the logging trend graph object include the following.

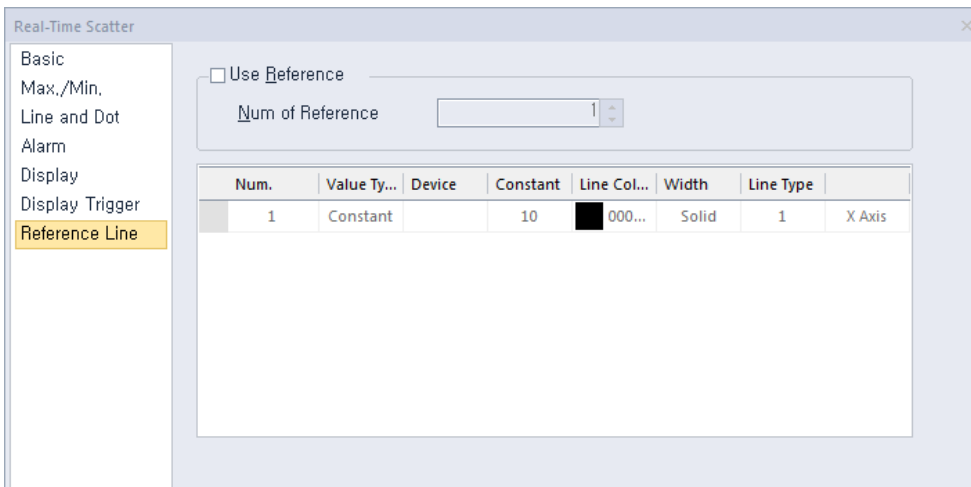

Note

In the **Max/Min** setting window, if **The Setting Type of Min/Max** is set to [Individual], **Reference Line** menu option is not displayed.

- **Use Reference:** Click the checkbox to use a reference line for the graph. A reference line refers to a line displaying the location of a specific value set by the user other than the maximum or minimum value.

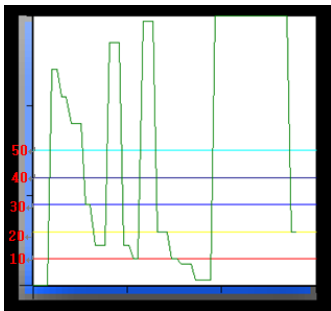

A reference line can be set as a fixed value or device value and it can be set only when the maximum and minimum values are set to [Block].

Num of Reference

Set the number of reference lines. When you enter the number of lines and move to the properties table of the reference lines, the corresponding number rows will be created to allow you adjust the properties. 1 to 8 reference lines can be created.

Reference Properties

You can set the properties only when Use Reference is checked. If the Value Type is set to Constant, you cannot enter a device. If the Value Type is set to Device, you cannot enter a fixed value. The number column is a reference line number. It cannot be edited and its location cannot be changed. If the line type of a reference line is set to Dash, the thickness can only be set to 1.

4.3.9 History Alarm Viewer Object

This section describes available settings for history alarm viewer objects.

Occurrence	Message	Group	Restore	Check	Frequency
2013/04/25			2013/04/25	2013/04/25	
2013/04/25			2013/04/25	2013/04/25	
2013/04/25			2013/04/25	2013/04/25	
2013/04/25			2013/04/25	2013/04/25	
2013/04/25			2013/04/25	2013/04/25	

Note

- The XGT Panel collects and stores history alarm data regularly even when a history alarm viewer object is not edited on the screen.
- You can use a special switch to delete history alarm data. Unrestored data cannot be deleted.
- When there is an insufficient number of history alarm viewer objects, use the History Alarm Viewer Page Down function of a special switch to move to the next page. You can also use the History Alarm Viewer Page Up function to move to the previous page.
- You can use the Print History Alarm function of a special switch to print history alarm data on the current screen.

- **Basic:** The basic settings for history alarm viewer objects are shown below.

- **Alarm Form:** Set the form at the alarm.

No. of Row	Set the number of rows to be displayed.
Sort	Set a sort method for the logging data (oldest first or newest first).

- **Use Detailed Window Position:** Specify the location of the details window.

Axis	[Detail window] is displayed at fixed position (X, Y)
Device	[Detail window] is displayed at each X and Y position according to the device value.

- **Show detail window when DoubleClick:** Instead of displaying the [Detail window] through a special switch, when double-clicking the history alarm that occurred in the history alarm view object, the [Detail window] is displayed.
- **Frame Display:** Specify options for the frame of the alarm viewer.

Frame Color	Select the frame color.
Plate Color	Select the background color for the table.

- **Line:** Set the color and width of the line.

Line Color	Select the line color of the frame.
Line Width	Set the line width of the frame.

- **Description:** Enter a description of the object.

- **State:** The state settings for history alarm viewer objects are shown in the below screenshot.

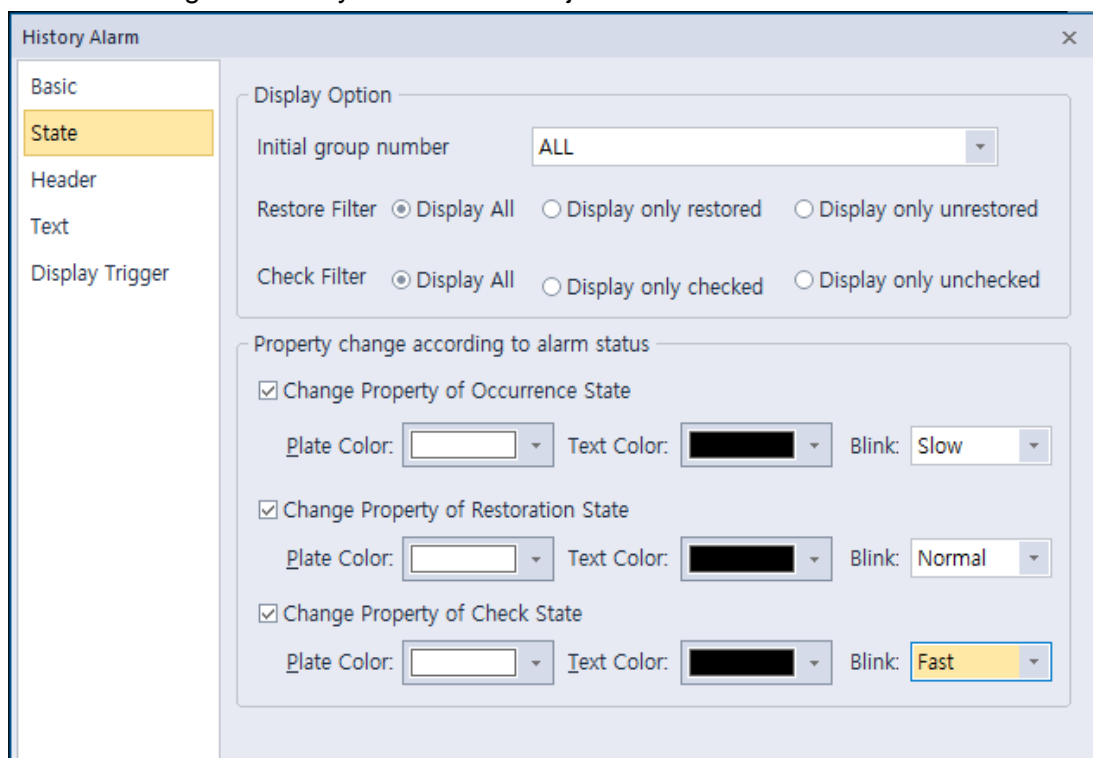

- **Initial Filtering Type:** Check the checkboxes to select the types of filters to use for the alarm data:

Restore Filter – Display All	Displays all the restored or unrestored history alarm data.
Restore Filter – Display only restored	Set to show history data for restored alarms.

	<table border="1"> <thead> <tr> <th>Occurrence</th> <th>Message</th> <th>Group</th> <th>Restore</th> <th>Check</th> <th>Frequency</th> </tr> </thead> <tbody> <tr> <td>2013/04/08</td> <td>Message 1</td> <td>Group1</td> <td>2013/04/08</td> <td></td> <td></td> </tr> <tr> <td>2013/04/08</td> <td>Message 2</td> <td>Group2</td> <td>2013/04/08</td> <td></td> <td></td> </tr> <tr> <td>2013/04/08</td> <td>Message 3</td> <td>Group3</td> <td>2013/04/08</td> <td></td> <td></td> </tr> </tbody> </table>	Occurrence	Message	Group	Restore	Check	Frequency	2013/04/08	Message 1	Group1	2013/04/08			2013/04/08	Message 2	Group2	2013/04/08			2013/04/08	Message 3	Group3	2013/04/08																																						
Occurrence	Message	Group	Restore	Check	Frequency																																																								
2013/04/08	Message 1	Group1	2013/04/08																																																										
2013/04/08	Message 2	Group2	2013/04/08																																																										
2013/04/08	Message 3	Group3	2013/04/08																																																										
<p>Restore Filter – Display only unrestored</p>	<p>Set to show history data for unrestored alarms.</p> <table border="1"> <thead> <tr> <th>Occurrence</th> <th>Message</th> <th>Group</th> <th>Restore</th> <th>Check</th> <th>Frequency</th> </tr> </thead> <tbody> <tr> <td>2013/04/08</td> <td>Message 1</td> <td>Group1</td> <td></td> <td></td> <td></td> </tr> <tr> <td>2013/04/08</td> <td>Message 2</td> <td>Group2</td> <td></td> <td></td> <td></td> </tr> <tr> <td>2013/04/08</td> <td>Message 3</td> <td>Group3</td> <td></td> <td></td> <td></td> </tr> </tbody> </table>	Occurrence	Message	Group	Restore	Check	Frequency	2013/04/08	Message 1	Group1				2013/04/08	Message 2	Group2				2013/04/08	Message 3	Group3																																							
Occurrence	Message	Group	Restore	Check	Frequency																																																								
2013/04/08	Message 1	Group1																																																											
2013/04/08	Message 2	Group2																																																											
2013/04/08	Message 3	Group3																																																											
<p>Check Filter – Display All</p>	<p>Displays all the checked or unchecked history alarm data.</p>																																																												
<p>Check Filter – Display only checked</p>	<p>Set to show history data for checked alarms.</p> <table border="1"> <thead> <tr> <th>Occurrence</th> <th>Message</th> <th>Group</th> <th>Restore</th> <th>Check</th> <th>Frequency</th> </tr> </thead> <tbody> <tr> <td>2013/04/08</td> <td>Message 1</td> <td>Group1</td> <td></td> <td>2013/04/08</td> <td></td> </tr> <tr> <td>2013/04/08</td> <td>Message 2</td> <td>Group2</td> <td></td> <td>2013/04/08</td> <td></td> </tr> <tr> <td>2013/04/08</td> <td>Message 3</td> <td>Group3</td> <td></td> <td>2013/04/08</td> <td></td> </tr> </tbody> </table>	Occurrence	Message	Group	Restore	Check	Frequency	2013/04/08	Message 1	Group1		2013/04/08		2013/04/08	Message 2	Group2		2013/04/08		2013/04/08	Message 3	Group3		2013/04/08																																					
Occurrence	Message	Group	Restore	Check	Frequency																																																								
2013/04/08	Message 1	Group1		2013/04/08																																																									
2013/04/08	Message 2	Group2		2013/04/08																																																									
2013/04/08	Message 3	Group3		2013/04/08																																																									
<p>Check Filter – Display only unchecked</p>	<p>Set to show history data for unchecked alarms.</p> <table border="1"> <thead> <tr> <th>Occurrence</th> <th>Message</th> <th>Group</th> <th>Restore</th> <th>Check</th> <th>Frequency</th> </tr> </thead> <tbody> <tr> <td>2013/04/08</td> <td>Message 1</td> <td>Group1</td> <td></td> <td></td> <td></td> </tr> <tr> <td>2013/04/08</td> <td>Message 2</td> <td>Group2</td> <td></td> <td></td> <td></td> </tr> <tr> <td>2013/04/08</td> <td>Message 3</td> <td>Group3</td> <td></td> <td></td> <td></td> </tr> </tbody> </table>	Occurrence	Message	Group	Restore	Check	Frequency	2013/04/08	Message 1	Group1				2013/04/08	Message 2	Group2				2013/04/08	Message 3	Group3																																							
Occurrence	Message	Group	Restore	Check	Frequency																																																								
2013/04/08	Message 1	Group1																																																											
2013/04/08	Message 2	Group2																																																											
2013/04/08	Message 3	Group3																																																											
<p>Initial Alarm Group</p>	<p>Set to show history data for a specific alarm group. After checking the checkbox, select an alarm group from the drop-down list. If you select an alarm navigator group, history data for all alarms will be shown.</p> <table border="1"> <thead> <tr> <th>Occurrence</th> <th>Message</th> <th>Group</th> <th>Restore</th> <th>Check</th> <th>Frequency</th> </tr> </thead> <tbody> <tr> <td>2013/04/08</td> <td>Message 1</td> <td>Group1</td> <td>2013/04/08</td> <td></td> <td></td> </tr> <tr> <td>2013/04/08</td> <td>Message 2</td> <td>Group1</td> <td>2013/04/08</td> <td></td> <td></td> </tr> <tr> <td>2013/04/08</td> <td>Message 3</td> <td>Group1</td> <td>2013/04/08</td> <td></td> <td></td> </tr> <tr> <td>2013/04/08</td> <td>Message 4</td> <td>Group2</td> <td></td> <td>2013/04/08</td> <td></td> </tr> <tr> <td>2013/04/08</td> <td>Message 8</td> <td>Group2</td> <td></td> <td>2013/04/08</td> <td></td> </tr> </tbody> </table> <p style="text-align: center;"><All occurred alarms></p> <p style="text-align: center;">↓</p> <table border="1"> <thead> <tr> <th>Occurrence</th> <th>Message</th> <th>Group</th> <th>Restore</th> <th>Check</th> <th>Frequency</th> </tr> </thead> <tbody> <tr> <td>2013/04/08</td> <td>Message 1</td> <td>Group1</td> <td>2013/04/08</td> <td></td> <td></td> </tr> <tr> <td>2013/04/08</td> <td>Message 2</td> <td>Group1</td> <td>2013/04/08</td> <td></td> <td></td> </tr> <tr> <td>2013/04/08</td> <td>Message 3</td> <td>Group1</td> <td>2013/04/08</td> <td></td> <td></td> </tr> </tbody> </table>	Occurrence	Message	Group	Restore	Check	Frequency	2013/04/08	Message 1	Group1	2013/04/08			2013/04/08	Message 2	Group1	2013/04/08			2013/04/08	Message 3	Group1	2013/04/08			2013/04/08	Message 4	Group2		2013/04/08		2013/04/08	Message 8	Group2		2013/04/08		Occurrence	Message	Group	Restore	Check	Frequency	2013/04/08	Message 1	Group1	2013/04/08			2013/04/08	Message 2	Group1	2013/04/08			2013/04/08	Message 3	Group1	2013/04/08		
Occurrence	Message	Group	Restore	Check	Frequency																																																								
2013/04/08	Message 1	Group1	2013/04/08																																																										
2013/04/08	Message 2	Group1	2013/04/08																																																										
2013/04/08	Message 3	Group1	2013/04/08																																																										
2013/04/08	Message 4	Group2		2013/04/08																																																									
2013/04/08	Message 8	Group2		2013/04/08																																																									
Occurrence	Message	Group	Restore	Check	Frequency																																																								
2013/04/08	Message 1	Group1	2013/04/08																																																										
2013/04/08	Message 2	Group1	2013/04/08																																																										
2013/04/08	Message 3	Group1	2013/04/08																																																										

<Alarm Group1 filtered>

- **Change Color by States:** Set the color of the rows based on the alarm state.

Change Property of Occurrence State	Set whether to change the background color/text color in case of occurrence among the history alarms that have occurred in the XGT Panel.
Occurrence Plate Color	In the case of the [Occurred] list among the history alarms that have occurred in the XGT Panel, the background color to indicate that the corresponding column has occurred is designated. If the user does not designate the background color of [Occurred data], the background color is displayed as [Basic]-[Plate color].
Occurrence Text Color	In the case of the [Occurred] list among the history alarms that have occurred in the XGT Panel, designate the text color to indicate that the corresponding column has occurred. If the user does not specify the text color of [Confirmed Data], the text color is displayed as [Text]-[Text Color].
Occurrence Blink	The occurred history alarm data blinks. Not Use: No blinking Slow: Blinks once every 3 seconds. Normal: Blinks once every 2 seconds. Fast: Blinks once every second.
Change Property of Check State	Sets whether background color / text color is changed in case of checked status alarm among XGT Panel.
Check Plate Color	Select a background color for rows of checked alarms. If you do not select a color, the default color set in the Frame Color option in Basic settings will be applied.
Check Text Color	Select a text color for rows of checked alarms. If you do not select a color, the default color set in the Color option in Text settings will be applied.
Check Blink	Checked history alarm data blinks. Not Use: No blinking Slow: Blinks once every 3 seconds. Normal: It blinks once every 2 seconds. Fast: Blinks once every second.
Change Property of Restoration State	Sets whether background color / text color is changed in case of restored status alarm among XGT Panel.
Restoration Plate Color	Set a background color for rows of restored alarms. If you do not select a color, the default color set in the Plate Color option in Basic settings will be applied.
Restoration Text Color	Select a text color for rows of restored alarms. If you do not select a color, the default color set in the Color option in Text settings will be applied.

Occurrence	Message	Group	Restore	Check	Frequency
2010/04/19	alarm#1	Group1		2010/04/19	1
2010/04/19	alarm#2	Group1			1
2010/04/19	alarm#4	Group1	2010/04/19		1
2010/04/19	alarm#3	Group1			1
2010/04/19	alarm#5	Group1			1

<All occurred alarms>

Occurrence	Message	Group	Restore	Check	Frequency
2010/04/19	alarm#3	Group1			1
2010/04/19	alarm#1	Group1	2010/04/19		1
2010/04/19	alarm#2	Group1			1
2010/04/19	alarm#5	Group1		2010/04/19	1
2010/04/19	alarm#4	Group1			1

<Different colored alarms>

Restoration Blink

Restored history alarm data blinks.
 Not Use: No blinking
 Slow: Blinks once every 3 seconds.
 Normal: It blinks once every 2 seconds.

- **Header:** The header settings for history alarm viewer objects are shown in the below screenshot.

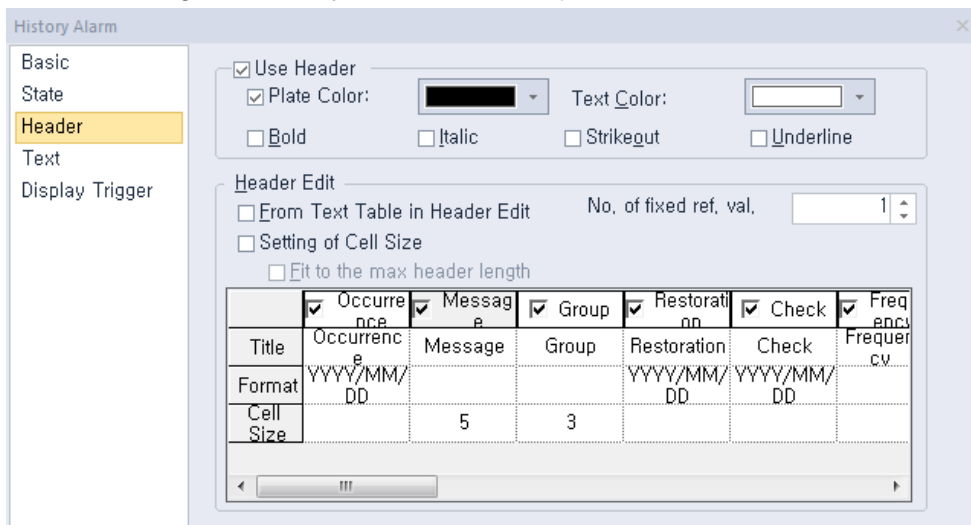

- **Use Header:** Set whether or not to use a header.

Plate Color	Select the background color for the header. When you set not to use the background color, it will be displayed as transparent.
Text Color	Select the text color for the header.

- **Header Edit:** Set additional header options.

From Text Table in Header Edit	Set to fetch header labels from a text table. When you set this option, the Title row is shown as below. Double-click the title area to select the appropriate text string from a text table.
---------------------------------------	---

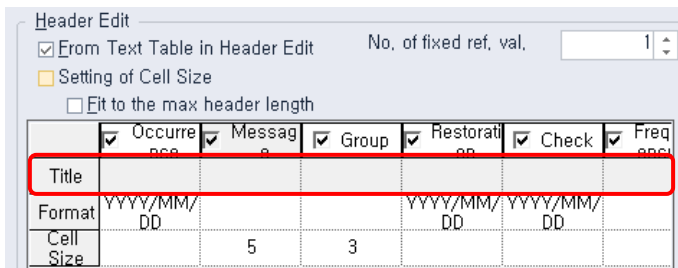

No. of fixed ref. val.

Set the number of reference value rows to show at one time on the XGT Panel display. To see additional rows, use the History Alarm Row Scroll function provided by a Special Switch. In the below example, the options are set as follows:

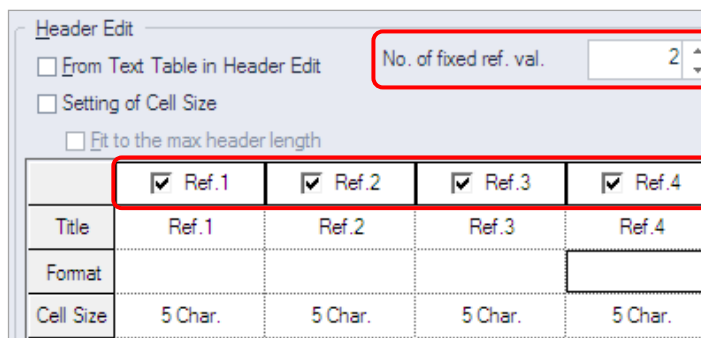

This allows you to view two reference rows at one time on the XGT Panel display:

Occurrence	Message	Group	Restore	Check	Frequency	Ref.1	Ref.2
2013/04/08			2013/04/08	2013/04/08			
2013/04/08			2013/04/08	2013/04/08			
2013/04/08			2013/04/08	2013/04/08			
2013/04/08			2013/04/08	2013/04/08			
2013/04/08			2013/04/08	2013/04/08			

Note

To view the next rows, you can use a special switch. Create the special switch in the editing area, and click [History Alarm Row Scroll] ► [Next row]. The rows are moved to the next rows as shown below:

Occurrence	Message	Group	Restore	Check	Frequency	Ref.3	Ref.4
2013/05/22			2013/05/22	2013/05/22			
2013/05/22			2013/05/22	2013/05/22			
2013/05/22			2013/05/22	2013/05/22			
2013/05/22			2013/05/22	2013/05/22			
2013/05/22			2013/05/22	2013/05/22			

If the reference rows are different sizes, some rows can be cut off as below:

Occurrence	Message	Group	Restore	Check	Frequency	Ref.1	Refered Tank n
2013/05/22			2013/05/22	2013/05/22			
2013/05/22			2013/05/22	2013/05/22			
2013/05/22			2013/05/22	2013/05/22			
2013/05/22			2013/05/22	2013/05/22			
2013/05/22			2013/05/22	2013/05/22			

To view the total data in the row, use the special switch again. Create the special switch in the editing area, and click [History Alarm Row Scroll] ► [Next row].

Fit to a max. header length

Set to fit the longest header length when you use the text table to input header titles. If you do not set this option, the header length changes whenever the runtime language is changed.

For example, refer to Character String 343 highlighted in the screenshot below for the heading Alarm History. If the language is set to Korean, “날짜및시간” will be displayed. If the language is set to English, “Date and Time” will be displayed. The size of the object is not fixed to allow variable character string lengths to be used for different languages.

번호	한국어(대한민국)	영문(미국)	중국어(중화, PRC)	일본어(일본)
335	선명	Ship Name	船名	船名
336	항차	Voyage No.	航次	航次
337	항구명	Call Port Name	港口名	埠一名
338	작동모드 설정	Operate Mode Set	运转模式设定	作動モード設定
339	점검모드 설정	Check Mode Set	检查模式设定	点検モード設定
340	탑재모드 설정	Ballast Mode Set	压载模式设定	搭載モード設定
341	출출모드 설정	Deballast Mode Set	卸載模式设定	排出モード設定
342	선명 및 항차연관정보 설정	Ship Name & Ship Voyage Data Set	船名以及船航次情報设定	船名と航次連関情報設定
343	날짜 및 시간	Date and Time	日期和时间	日付と時間
344	알림 메시지	Alarm Message	报警信息	警報のメッセージ

If “Fit to the max header length” is set, the width of a character string is always set to the longest heading (“Date and Time” in this case) regardless of the language.

Setting of Cell Size

Set to adjust the size of each column. The size of reference columns can be set in the number of characters. The size of the other columns can be set in pixels. If you do not set this option, you can set only the length of the Message and Group columns. The rest of the columns differ by header type and font. When you change the size of the history alarm viewer object, the Message and Group columns are changed based on the value you set in Cell Size. In the below example, the sizes of the Message and Group columns are set as follows.

	<input checked="" type="checkbox"/> Occurrence	<input checked="" type="checkbox"/> Message	<input checked="" type="checkbox"/> Group	<input checked="" type="checkbox"/> Restore	<input checked="" type="checkbox"/> Check	<input checked="" type="checkbox"/>
Title	Occurrence	Message	Group	Restore	Check	Fre
Format	YYYY/MM/DD			YYYY/MM/DD	YYYY/MM/DD	
Cell Size		5	3			

In this case, the cell sizes of the Message and Group columns are changed to “5” and “3”, respectively:

Occurrence	Message	Group	Restore	Check	Frequency	Ref. 1	Ref. 2
2013/04/08			2013/04/08	2013/04/08			
2013/04/08			2013/04/08	2013/04/08			
2013/04/08			2013/04/08	2013/04/08			
2013/04/08			2013/04/08	2013/04/08			
2013/04/08			2013/04/08	2013/04/08			

5 : 3

Note

- You can change the order of headers (Occurrence, Message, Group, Restoration, Check, and more). Drag and drop a header to the desired place.

	<input checked="" type="checkbox"/>	Occurrence	<input checked="" type="checkbox"/>	Message	<input checked="" type="checkbox"/>	Group	<input checked="" type="checkbox"/>	Restore	<input checked="" type="checkbox"/>	Check	<input checked="" type="checkbox"/>
Title		Occurrence		Message		Group		Restore		Check	Frequency
Format		YYYY/MM/DD						YYYY/MM/DD		YYYY/MM/DD	
Cell Size			5		3						



	<input checked="" type="checkbox"/>	Restore	<input checked="" type="checkbox"/>	Occurrence	<input checked="" type="checkbox"/>	Message	<input checked="" type="checkbox"/>	Group	<input checked="" type="checkbox"/>	Check	<input checked="" type="checkbox"/>
Title		Restore		Occurrence		Message		Group		Check	Frequency
Format		YYYY/MM/DD		YYYY/MM/DD						YYYY/MM/DD	
Cell Size					5		3				

- You cannot reduce the row size below the size of the header text. The minimum row size is the same as the header text length.
- Rows cannot be reduced to the extent that the data or header of the selected row cannot be displayed. That is, the minimum size is when the data and header of all the selected rows can be displayed.
- The address display string displays the devices set in the Project pane - [History Alarm]-[Alarm Group]-[Alarm List].

No.	Device	Alarm Condition	Window No.	Text Index	Alarm Count Device
1	H00000	On/Off	0		
2	H00001	On/Off	0		
3	H00002	On/Off	0		
4	H00003	On/Off	0		
5	H00005	On/Off	0		
6	H00006	On/Off	0		
7	H00007	On/Off	0		
8	H00008	On/Off	0		

Occurrence	Message	Restoration	Check	Frequency	Address
2015/07/24	No.1 Device Alarm Occured			1	HX00000

Reference Value of Fixed Column

The reference value for generated history alarms can be set in the Project pane - [History Alarm]-[Alarm Group]-[Alarm List].

No.	Window No.	Text Index	Alarm Count Device	Preview	Parameter	Reference1	Reference2	Reference3	Reference4	Reference5
1	0	0								
2	0	0								
3	0	0								
4	0	0								
5	0	0								
6	0	0								
7	0	0								
8	0	0								

- **Text:** The text settings for history alarm viewer objects are shown in the below screenshot.

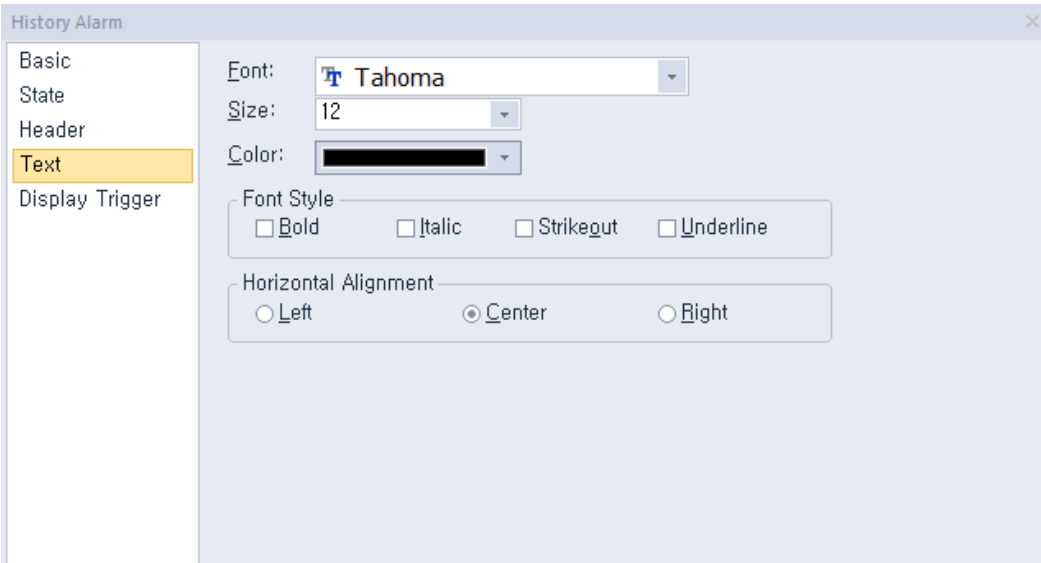

- **Font:** Select a font from the drop-down list.
- **Size:** Select a text size from the drop-down list or enter a value directly into the field.
- **Color:** Select a font color.
- **Font Style:** Select a font style (bold, italic, strikeout, or underline). You can apply more than one option at a time.
- **Horizontal Alignment:** Set the horizontal alignment (left, center, or right).

- **Display Trigger:** The display trigger settings for history viewer alarm objects are shown in the below screenshot.

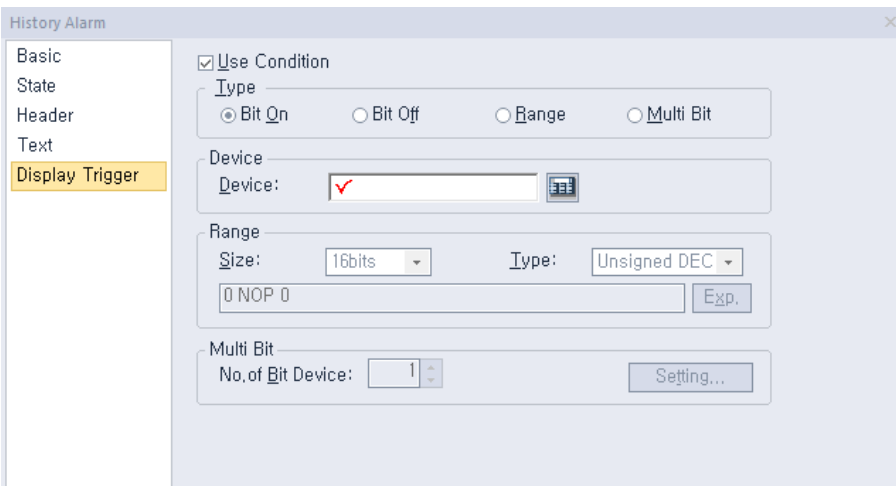

- **Use Condition:** Set whether or not to specify a condition for the action.
- **Type:** Set a type of condition to specify.

Bit On	The action is performed when the device is switched on.
Bit Off	The action is performed when the device is switched off.
Range	The action is performed when the value falls within the specified

	range.
Multi Bit	The action is performed when the logical operation result of multiple devices is met.

- **Device:** Enter a device or tag address directly into the input field or click the keypad icon to the right to specify a device or tag address. When you click the keypad icon to open the Device window, you can also specify network settings, if necessary.
- **Range:** If you select the range condition, specify the range.

Size	16 bit or 32 bit.
Type	Signed decimal, unsigned decimal, BCD, or float.
Exp.	Click to designate the expression as conditional.

- **Multi Bit:** If you select the multi bit condition, specify the number of bits and click [Setting] to specify the bit conditions.

4.3.10 Data List Object

Data list objects allow you to read consecutive values and display them in a table. This section describes available settings for data list object.

- **Basic:** The basic settings for data list objects are shown in the below screenshot.

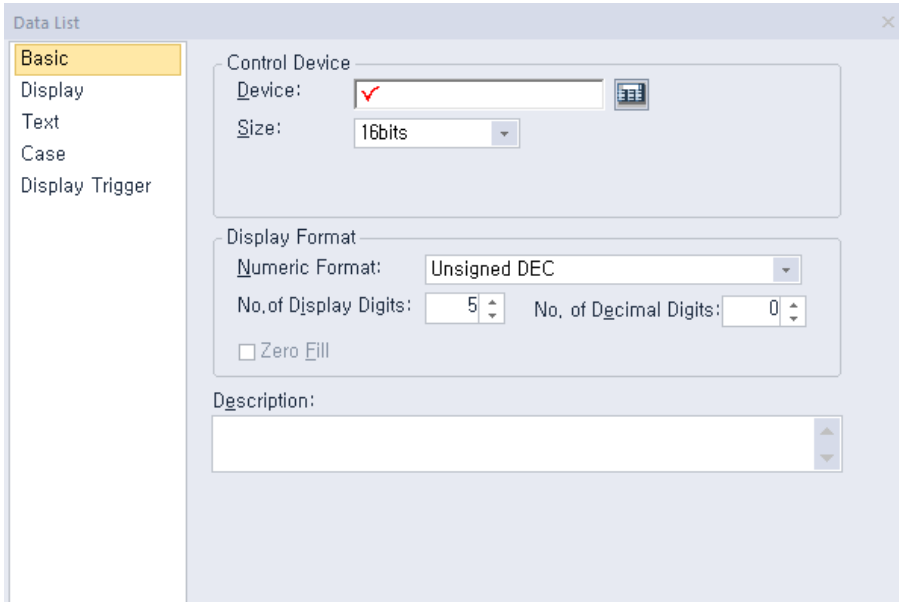

- **Control Device:** Specify the following options for the control device.

Device	Enter a device or tag address directly into the input field or click the keypad icon to the right to specify a device or tag address. When you click the keypad icon to open the Device window, you can also specify network settings, if necessary.
Size	Set the data size of the device (16 bit or 32 bit).

Note

- If the size and type of data are changed, the case settings will be deleted.
- If communication with the PLC fails, the data values will not be displayed.
- If the device number exceeds the maximum device range, the values on the data list may differ from the actual values of the PLC.

- **Display Format:** Set the display format.

Numeric Format	Set the number format (signed decimal, unsigned decimal, octal, hexadecimal, and binary, BCD, or float).
No. of Display Digits	Set how many digits to display (up to 64). If the number of digits is less than the capacity of the device, empty spaces are filled with placeholders (“*”). If the device value cannot be displayed in the BCD format, it is expressed as “~”.
No. of Decimal Digits	Set how many places to put to the right of the decimal point when you select formats other than binary, octal, and hexadecimal.

Zero Fill

If you have selected right justification, select this option to insert zeros (0) before the number.

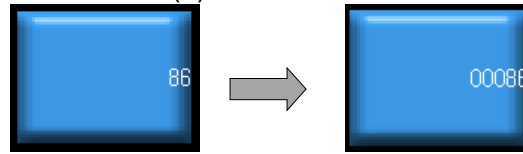

- **Description:** Enter a description of the object.

- **Display:** The display settings for data list objects are shown in the below screenshot.

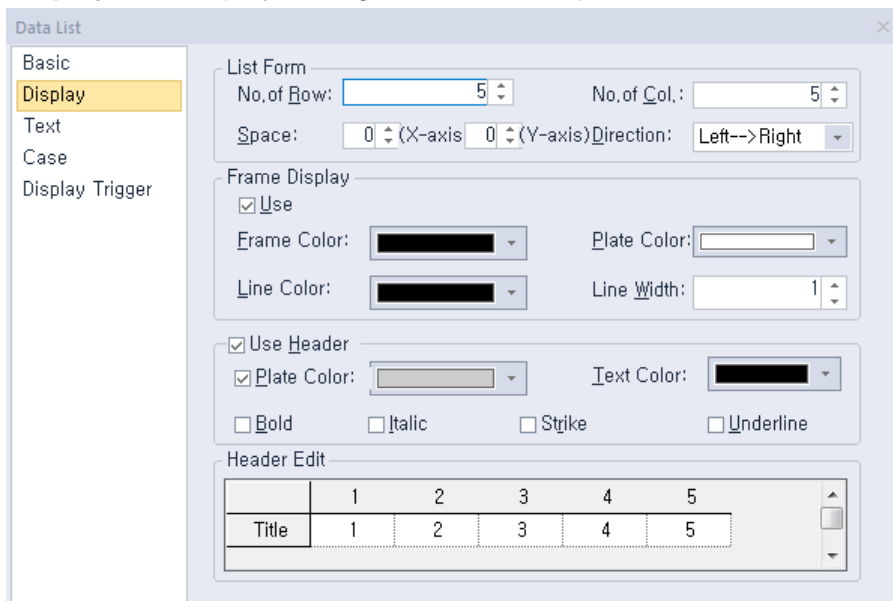

- **List Form:** Specify the form at the list.

No. of Row	Set the number of rows.
No. of Col.	Set the number of columns.
Space	Specify the size of the area where the data will be shown (0 to 32 for each axis)
Direction	Set the direction to display the data (top > bottom or left > right).

- **Frame Display:** Set whether or not to use a frame.

Frame Color	Select the frame color.
Plate Color	Select the background color for the table.
Line Color	Select the line color for the frame.
Line Width	Set the line width for the frame.

- **Use Header:** Set whether or not to use a header.

Plate Color	Select the background color for the header.
Text Color	Select the text color for the header.

- **Header Edit:** Click column headers to select text strings from a text table.

- **Text:** The text settings for data list objects are shown in the screenshot below.

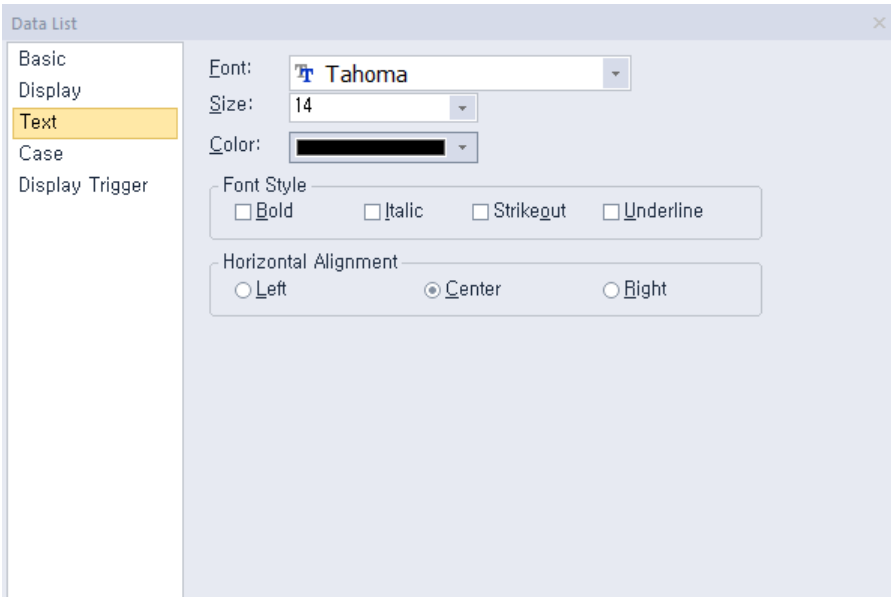



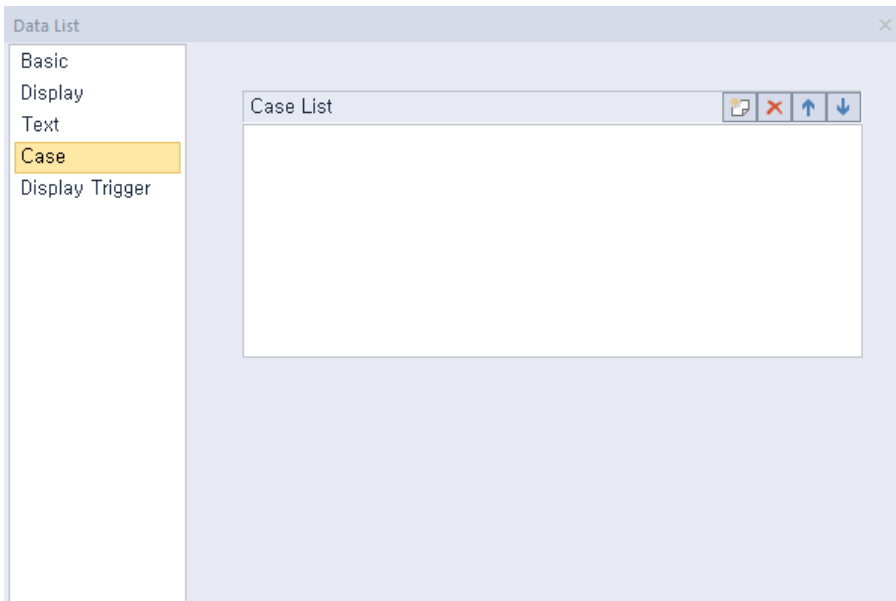

- **Font:** Select a font from the drop-down list.
- **Size:** Select a text size from the drop-down list or enter a value directly into the field.
- **Color:** Select a font color.
- **Font Style:** Select a font style (bold, italic, strikeout, or underline). You can apply more than one option at a time.
- **Horizontal Alignment:** Set the horizontal alignment (left, center, or right).

- **Case:** The case settings for data list objects are shown in the screenshot below.



- **Case List:** Create, delete, or reorganize conditional expressions:

 (Create)	Click to create a new range condition. You can create up to eight conditions. Clicking this icon opens the Range Edit window, which allows you to create a condition. For more information, refer to <4.2.1.3 Understanding Constants and Data Types> .
 (Delete)	Click a condition and then click this icon to delete the condition.
 (Up)	Click a condition and then click this icon to move it higher up the list.
 (Down)	Click a condition and then click this icon to move it lower down the list.

In the Range Edit window, you can adjust the settings for the plate color and text color.

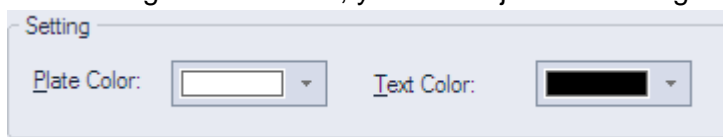
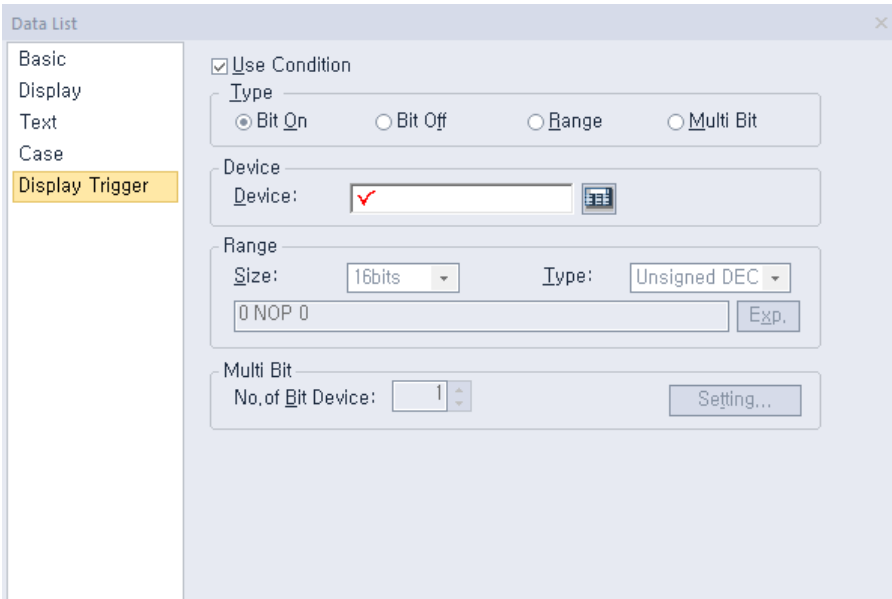

Plate Color	Select the background color of a data list.
Text Color	Select the text color of data in a data list.

- **Display Trigger:** The display trigger settings for data list objects are shown in the below screenshot.



- **Use Action Condition:** Set whether or not to specify a condition for the action.
- **Type:** Set a type of condition to specify.

Bit On	The action is performed when the device is switched on.
Bit Off	The action is performed when the device is switched off.
Range	The action is performed when the value falls within the specified range.
Multi Bit	The action is performed when the logical operation result of multiple devices is met.

- **Device:** Enter a device or tag address directly into the input field or click the keypad icon to the right to specify a device or tag address. When you click the keypad icon to open the Device window, you can also specify network settings, if necessary.
- **Range:** If you select the range condition, specify the range.

Size	16 bit or 32 bit.
Type	Signed decimal, unsigned decimal, BCD, or float.
Exp.	Click to designate the expression as conditional.

- **Multi Bit:** If you select the multi bit condition, specify the number of bits and click [Setting] to specify the bit conditions.

4.3.11 Logging Viewer Object

This section describes available settings for logging viewer objects.

Number	Date	Value	Value...
100000	2013/4/25 13:11:52	12345	12345
100000	2013/4/25 13:11:52	12345	12345
100000	2013/4/25 13:11:52	12345	12345

- **Main:** The main settings for logging viewer objects are shown in the screenshot below.

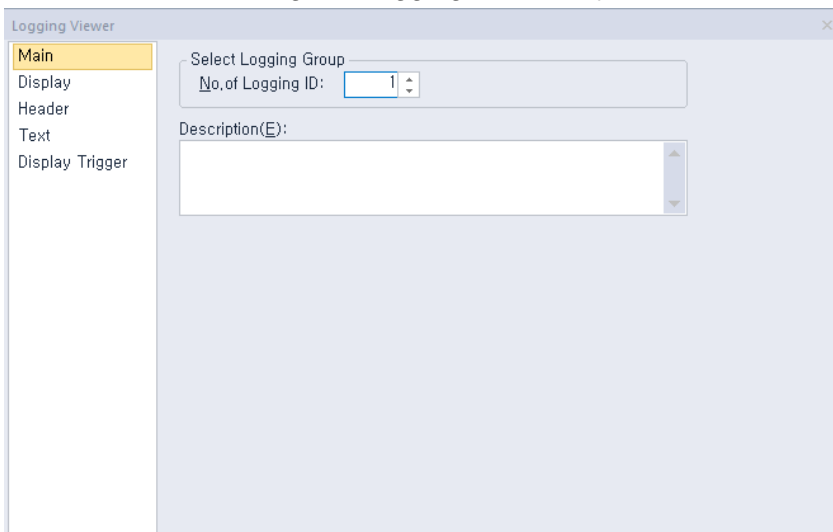

- **Select Logging Group:** Set the number of the logging group to monitor. A number of a logging group refers to the number that you set in [COMMON] ► [Logging Setting].
 - **Description:** Enter a description of the object.
- **Display:** The display settings for logging viewer objects are shown in the below screenshot.

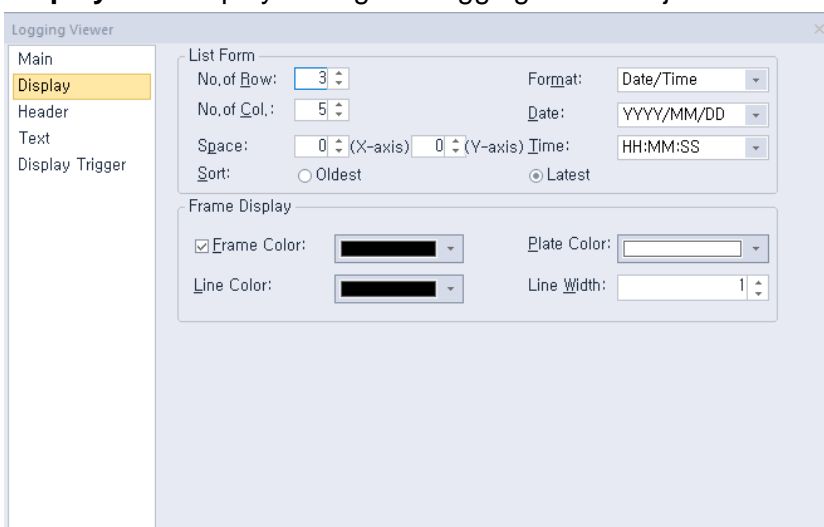

- **List Form:** Specify the form at the list.

No. of Row

Set the number of rows.

No. of Col.	Set the number of columns.																
Space	Specify the size of the area where the data will be shown (0 to 32 for each axis).																
Format	Set the data format. <table border="1" style="margin-left: 20px;"> <thead> <tr> <th>Item</th> <th>Description</th> </tr> </thead> <tbody> <tr> <td>Date/Time</td> <td>Date and time</td> </tr> <tr> <td>Date</td> <td>Date</td> </tr> <tr> <td>Time</td> <td>Time</td> </tr> </tbody> </table>	Item	Description	Date/Time	Date and time	Date	Date	Time	Time								
Item	Description																
Date/Time	Date and time																
Date	Date																
Time	Time																
Date	Set the date format. <table border="1" style="margin-left: 20px;"> <thead> <tr> <th>Item</th> <th>Description</th> </tr> </thead> <tbody> <tr> <td>YYYY/MM/DD</td> <td>Year/Month/Date (4-digit year)</td> </tr> <tr> <td>YY/MM/DD</td> <td>Year/Month/Date (2-digit year)</td> </tr> <tr> <td>MM/DD/YYYY</td> <td>Month/Date/Year (4-digit year)</td> </tr> <tr> <td>MM/DD</td> <td>Month/Date</td> </tr> <tr> <td>MM/DD/YY</td> <td>Month/Date/Year (2-digit year)</td> </tr> <tr> <td>DD/MM/YYYY</td> <td>Date/Month/Year (4-digit year)</td> </tr> <tr> <td>DD/MM/YY</td> <td>Date/Month/Year (2-digit year)</td> </tr> </tbody> </table>	Item	Description	YYYY/MM/DD	Year/Month/Date (4-digit year)	YY/MM/DD	Year/Month/Date (2-digit year)	MM/DD/YYYY	Month/Date/Year (4-digit year)	MM/DD	Month/Date	MM/DD/YY	Month/Date/Year (2-digit year)	DD/MM/YYYY	Date/Month/Year (4-digit year)	DD/MM/YY	Date/Month/Year (2-digit year)
Item	Description																
YYYY/MM/DD	Year/Month/Date (4-digit year)																
YY/MM/DD	Year/Month/Date (2-digit year)																
MM/DD/YYYY	Month/Date/Year (4-digit year)																
MM/DD	Month/Date																
MM/DD/YY	Month/Date/Year (2-digit year)																
DD/MM/YYYY	Date/Month/Year (4-digit year)																
DD/MM/YY	Date/Month/Year (2-digit year)																
Time	Set the time format. <table border="1" style="margin-left: 20px;"> <thead> <tr> <th>Item</th> <th>Description</th> </tr> </thead> <tbody> <tr> <td>HH:MM:SS</td> <td>Hour:Minute:Second</td> </tr> <tr> <td>HH:MM</td> <td>Hour:Minute</td> </tr> </tbody> </table>	Item	Description	HH:MM:SS	Hour:Minute:Second	HH:MM	Hour:Minute										
Item	Description																
HH:MM:SS	Hour:Minute:Second																
HH:MM	Hour:Minute																
Sort	Set the sorting method (oldest data first or most recent data first).																

- **Frame Display:** Set whether or not to use a frame.

Frame Color	Select the frame color.
Plate Color	Select the background color for the table.
Line Color	Select the line color for the frame.
Line Width	Set the line width for the frame.

Note

- Only one logging viewer object can be set in one screen.
- When “#” or “*” is displayed in a logging viewer object, refer to [COMMON] ► [Logging Setting].

- **Header:** The header settings for logging viewer objects are shown in the below screenshot.

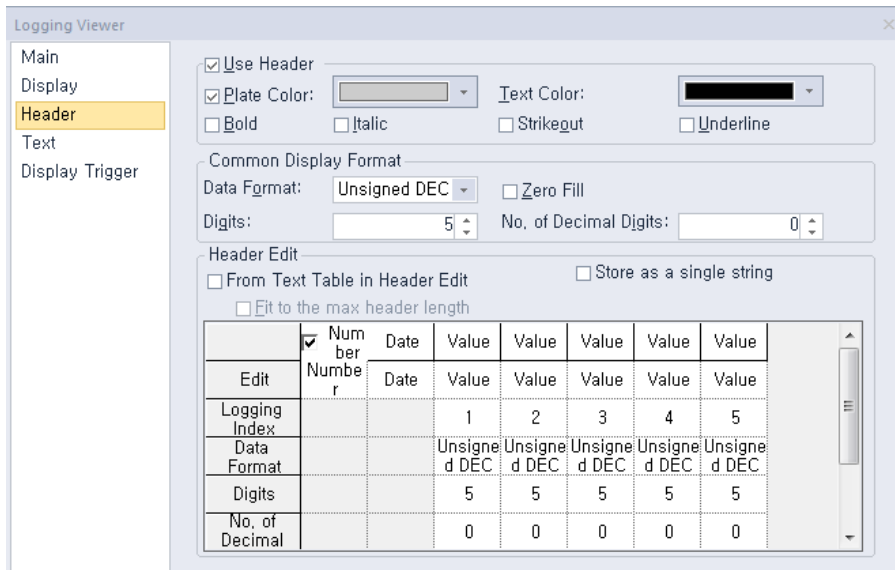

- **Use Header:** This option enables or disables the heading in Logging view. If the heading is disabled, it cannot be entered and is not displayed on the XGT Panel.

Plate Color	Select the background color for the header.
Text Color	Select the text color for the header.
Bold	Set the text in the header to appear in boldface.
Italic	Set the text in the header to appear in italics.
Strikeout	Adds a line through the middle of the selected text.
Underline	Adds a line under the selected text.

- **Common Display Format:** Set this option to apply the settings to all index data. To change the data, use the Header Edit option.

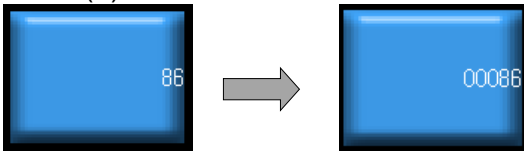
Data Format	Set the display type.
Digits	Set how many digits to display (up to 64). If the number of digits is less than the capacity of the device, empty spaces are filled with placeholders (“*”). If the device value cannot be displayed in BCD format, it is expressed as “~”.
Zero Fill	If you have selected right justification, select this option to insert zeros (0) before the number. 
No. of Decimal Digits	Set how many places to put to the right of the decimal point when you select formats other than binary, octal, and hexadecimal. Example 1)

When logging data type is set to integer (16bit), display format is set to unsigned decimal, number of displays is set to 5, and decimal point length is set to 2

- Logging data value: 12345
- Value displayed in logging viewer: 123.45

If the logging data value is an integer, the decimal point is stamped in the place corresponding to the decimal point length set in the input data.

Example 2)

When the logging data type is set to real number (32bit), display format is set to real number, number of displays is set to 5, and decimal point length is set to 2

- Logging data value: 123
- Value displayed in logging viewer: 123.00

If the logging data value is an integer value that is less than or equal to the displayed number, the decimal point is stamped in the place corresponding to the decimal point length.

Example 3)

When the type of logging data is set to real number (32bit), display format to decimal, number to be displayed to 5, and decimal point length to 2

- Logging data value: 123.4
- Value displayed in logging viewer: 123.4

If the logging data value is a real value less than or equal to the displayed number, it is displayed the same as the input logging data value.

- **Header Edit:** Click column headers to select text strings from a text table.

From Text Table in Header Edit

Set to fetch header labels from a text table. Click a column header to select the appropriate text string from a text table.

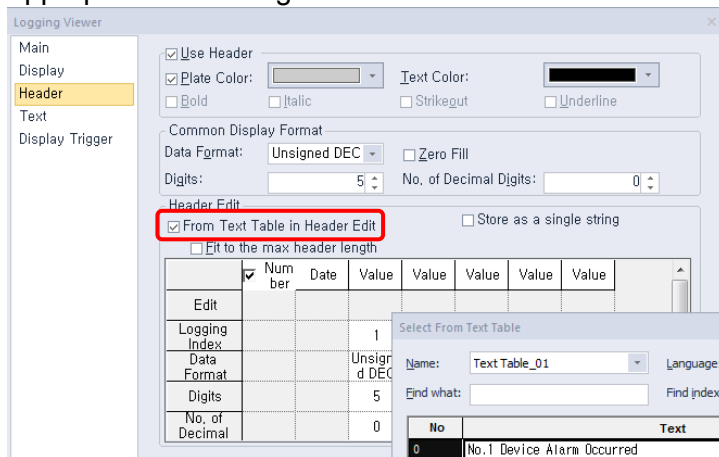

Multilingual

If the output format is set to text, show in chosen language.

[Setting of Cell Size] and [Setting

You can display the logged values in different device sizes by column. For example, after defining 15 values from M0 (as shown below), you can set the “Load” and “Estimated shipment” columns to have an 8 byte (32 bits) format; the “Inlet

Device Size per Col.]

temperature” column to have a 4 byte (16 bits) format; and the “Ship name” column to have a 20 byte text string format.

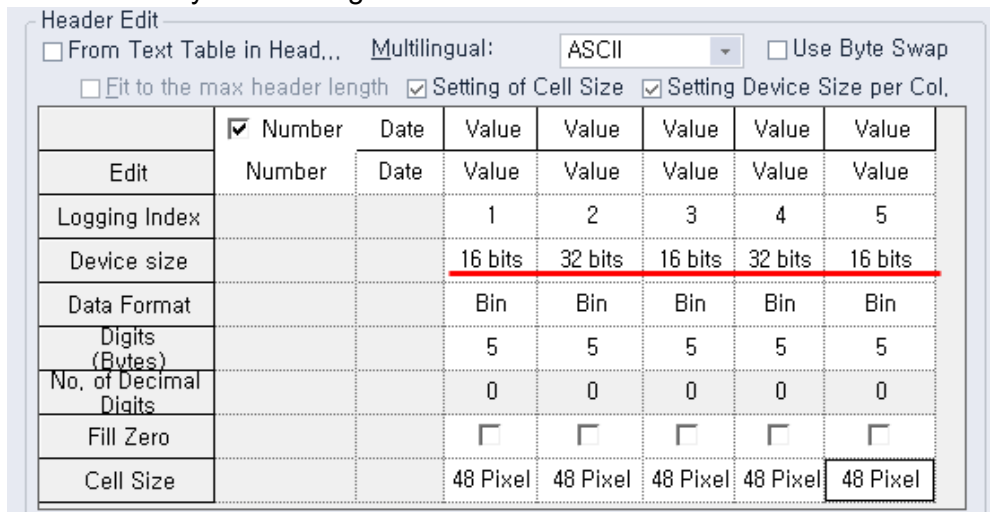

For

example, If every logging column has a different device size(16 bit, 32 bit, repeated text) used together

Number	Date	Value1 (Device : M0, M1)	Value2 (Device : M2, M3)	Value3 (Device : M4)	Value4 (Device : M5–M15)
1	19/08/2018 20:10	0x3143889 1	0x1356770 1	0x135 6	BALASHI P 19

The settings to display a table as above are shown in the screenshot below.

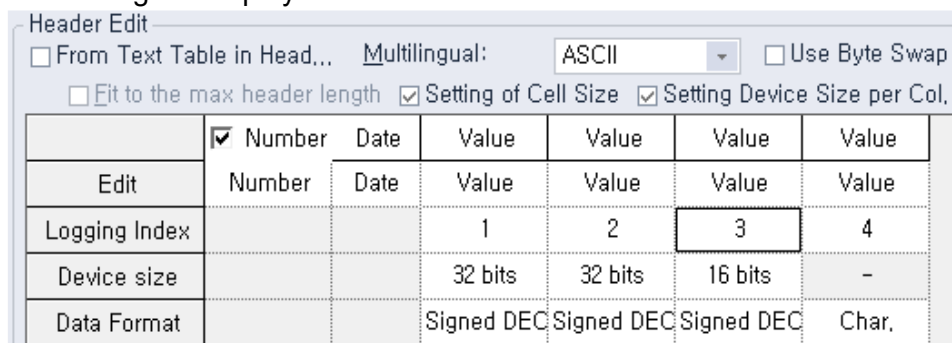

The

following features not supported by XP30-BTE, XP30-TTE, and XP40-TTE, XP50-TTE.

Fit to a max. header length

Set to fit the longest header length when you use the text table to input header titles. If you do not set this option, the header length changes whenever the runtime language is changed. For example, in the character string highlighted in the screenshot below, string no. 2 is specified as the heading in logging view. If the editing language is set to [English], it displays “Ballast”. If the editing language is set to [Korean], it displays “밸러스트탑재”. The object size is adjusted automatically based on the string length.

No	English (United States)	Korean (Korea)	Chinese (Simplified, PRC)	Japanese (Japan)
0	No.	번호	编号	番号
1	Date and Time	날짜 및 시간	日期和时间	日付と時間
2	Ballast	발러스트탑재	压载	灯管灯座
3	SW Inlet Press	海水入口压	海水入口压力	海水入口压力
4	SW Outlet Press	海水出口压	海水出口压力	海水出口压力
5	SW Inlet Temp	海水入口温度	海水入口温度	海水入口温度
6	SW Outlet Temp	海水出口温度	海水出口温度	海水出口温度
7	Average Flow Rate	平均流量	平均流量	平均流量
8	UV Transmitt	UV透射率	UV透射率	UV透射率

[If the Fit to a max. heading length option is set, the object sizes change regardless of the editing language.]

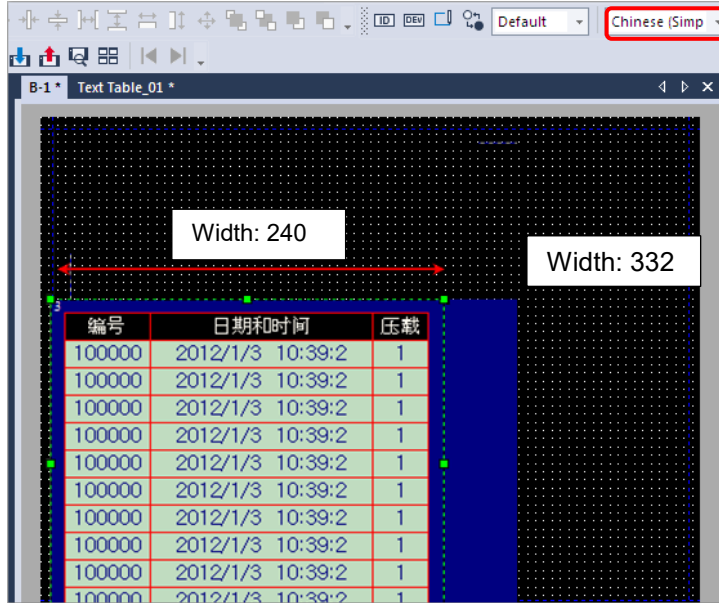

Switched to Korean language (variable size)

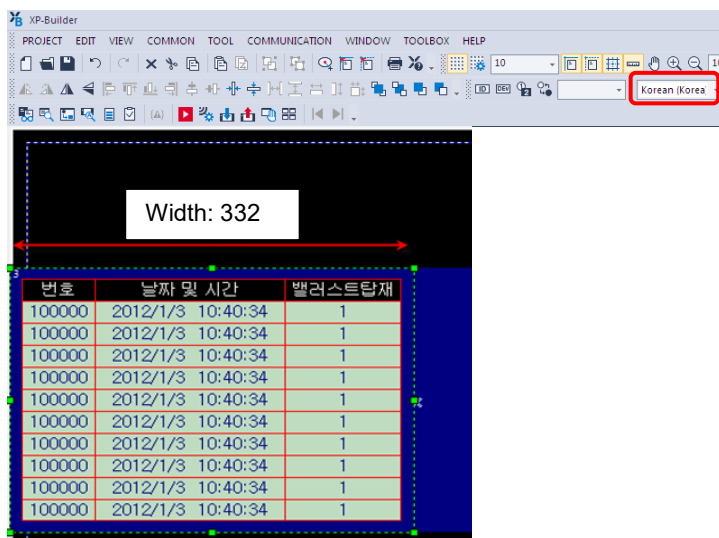

[If the Fit to a max. heading length option is not set, the object size does not change regardless of the editing language.]

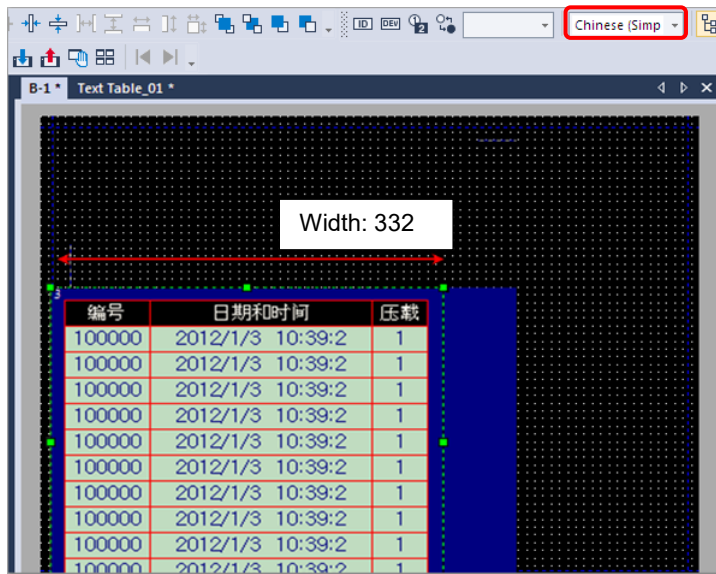

Switched to Korean language (fixed size)

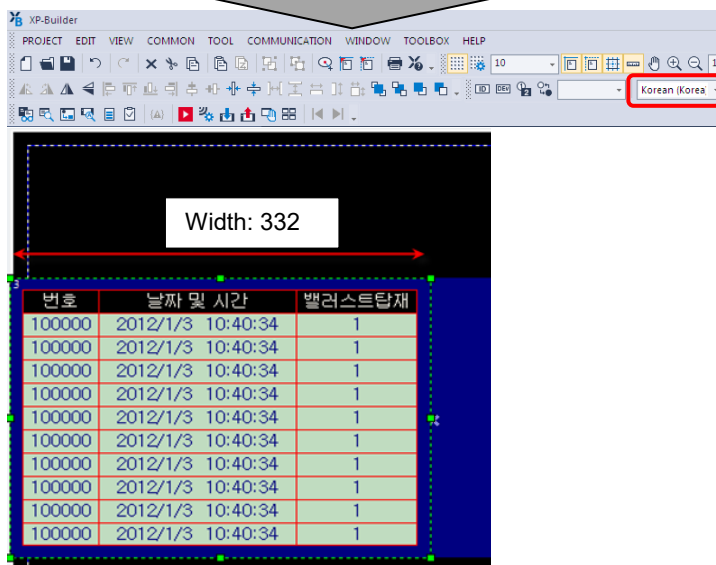

- **Logging index:** Shows the index number of the device. The index numbers of logging devices starts at “1” and increases by one as the device address increases. As you can see in the example below, when 32 devices from P0100 are edited to be logged, the index numbers of the four devices - P0001, P0005, P0010, and P0018 - from the 32 devices are as follows.

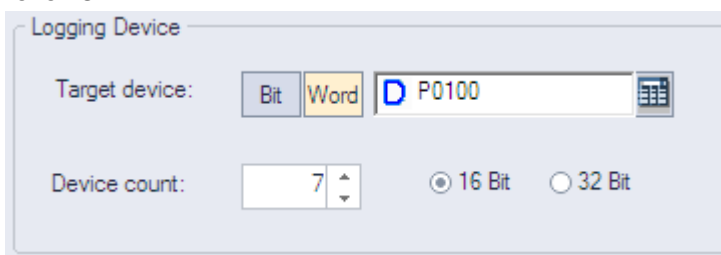

Device address	Logging index
P0001 (logging device)	1
P0002	2
...	...
P0005	5
...	...
P0010	10
...	...
P0018	18

Note

If the target device of a logging group is not 32-bit, an error occurs while checking the data when the data type of a logging viewer object is set to "Float".

- **Text:** The text settings for logging viewer objects are shown in the below screenshot.

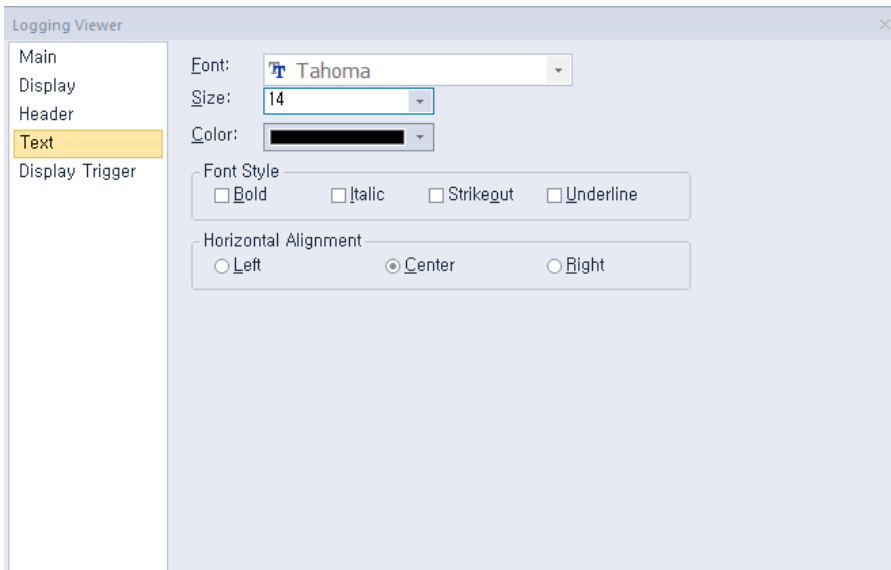

- **Font:** Select a font from the drop-down list.
 - **Size:** Select a text size from the drop-down list or enter a value directly into the field.
 - **Color:** Select a font color.
 - **Font Style:** Select a font style (bold, italic, strikeout, or underline). You can apply more than one option at a time.
 - **Horizontal Alignment:** Set the horizontal alignment (left, center, or right).
- **Display Trigger:** The display trigger settings for the logging viewer objects are shown in the below screenshot.

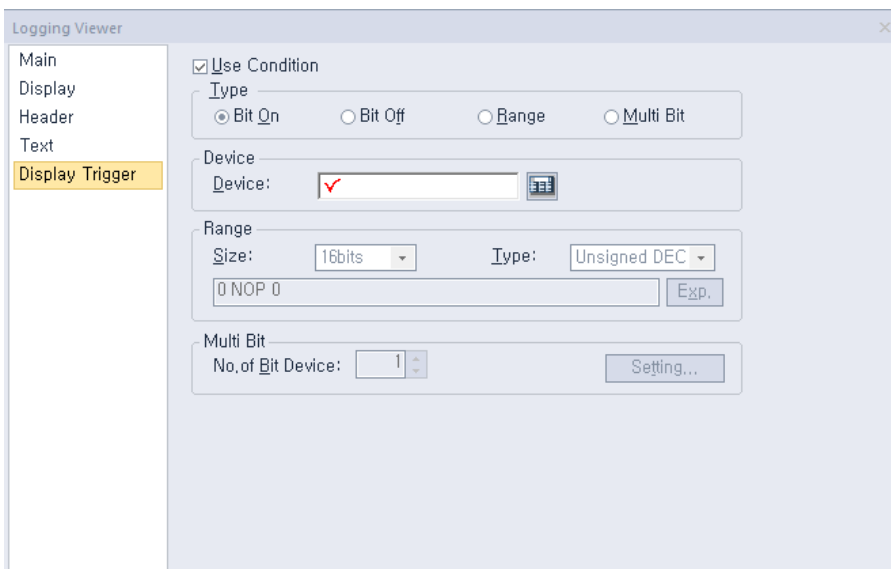

- **Use Condition:** Set whether or not to specify a condition for the action.
- **Type:** Set a type of condition to specify.

Bit On	The action is performed when the device is switched on.
Bit Off	The action is performed when the device is switched off.

Range	The action is performed when the value falls within the specified range.
Multi Bit	The action is performed when the logical operation result of multiple devices is met.

- **Device:** Enter a device or tag address directly into the input field or click the keypad icon to the right to specify a device or tag address. When you click the keypad icon to open the Device window, you can also specify network settings, if necessary.
- **Range:** If you select the range condition, specify the range.

Size	16 bit or 32 bit.
Type	Signed decimal, unsigned decimal, BCD, or float.
Exp.	Click to designate the expression as conditional.

- **Multi Bit:** If you select the multi bit condition, specify the number of bits and click [Setting] to specify the bit conditions.

4.3.12 Alarm Navigator Object

The alarm navigator object allows you to conveniently view the alarm history. This section describes available settings for alarm navigator objects.

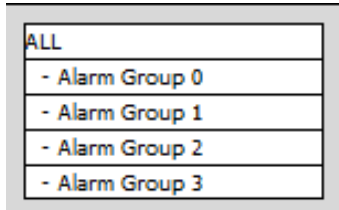

Note

Alarm group names displayed in an alarm navigator object are the group names that have been set when creating history alarms. Therefore, the text color and properties are shared from those of the text table that has been set as the group number.

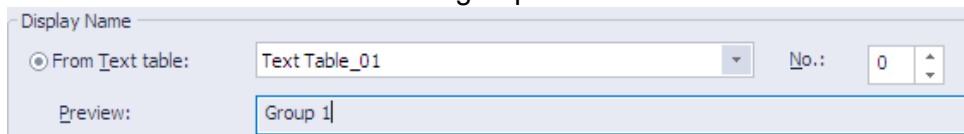

- **Basic:** The basic settings for alarm navigator objects are shown in the below screenshot.

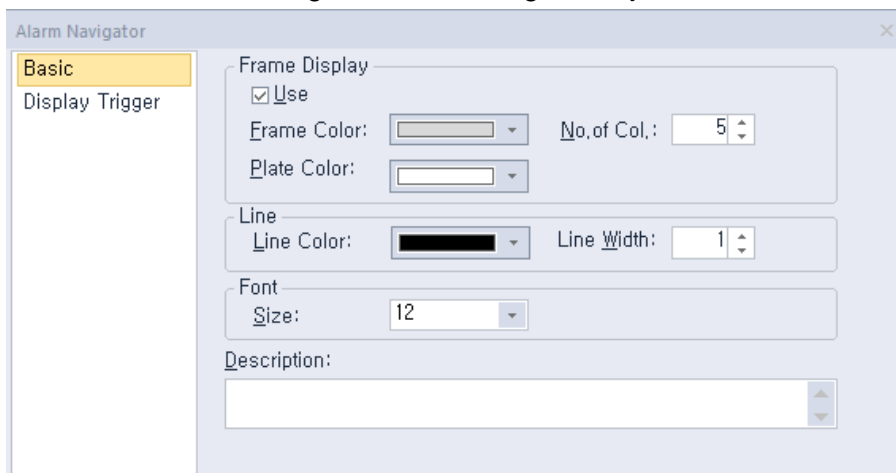

- **Frame Display:** Set whether or not to use a frame.

Frame Color	Select the frame color.
Plate Color	Select the background color for the table.
No. of Col.	Set the number of columns to show.

- **Line:** Set the line properties.
- **Font:** Set the font size.
- **Description:** Enter a description of the object.

- **Display Trigger:** The display trigger settings for recipe navigator objects are shown in the screenshot below.

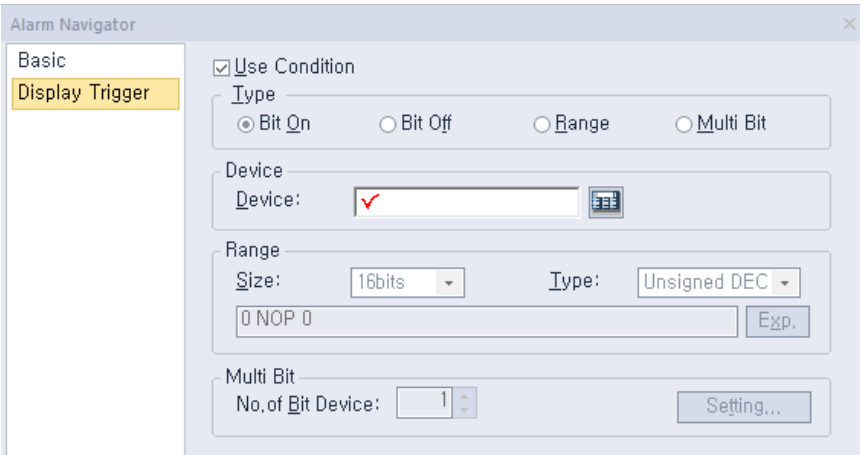

- **Use Action Condition:** Set whether or not to specify a condition for the action.
- **Type:** Set a type of condition to specify.

Bit On	The action is performed when the device is switched on.
Bit Off	The action is performed when the device is switched off.
Range	The action is performed when the value falls within the specified range.
Multi Bit	The action is performed when the logical operation result of multiple devices is met.

- **Device:** Enter a device or tag address directly into the input field or click the keypad icon to the right to specify a device or tag address. When you click the keypad icon to open the Device window, you can also specify network settings, if necessary.
- **Range:** If you select the range condition, specify the range.

Size	16 bit or 32 bit.
Type	Signed decimal, unsigned decimal, BCD, or float.
Exp.	Click to designate the expression as conditional.

- **Multi Bit:** If you select the multi bit condition, specify the number of bits and click [Setting] to specify the bit conditions.

4.3.13 Explorer

This object displays a list of the file recipes saved in the storage device (USB, CF Card) or the basic recipes edited in XP-Builder. You can write the recipe data shown in the recipe navigator object directly to the controller. This section describes available settings for Recipe Explorer. For more details about recipes, refer to **<4.1.4 Recipes>**.

- **Basic:** The basic settings for recipe navigator objects are shown in the screenshot below.

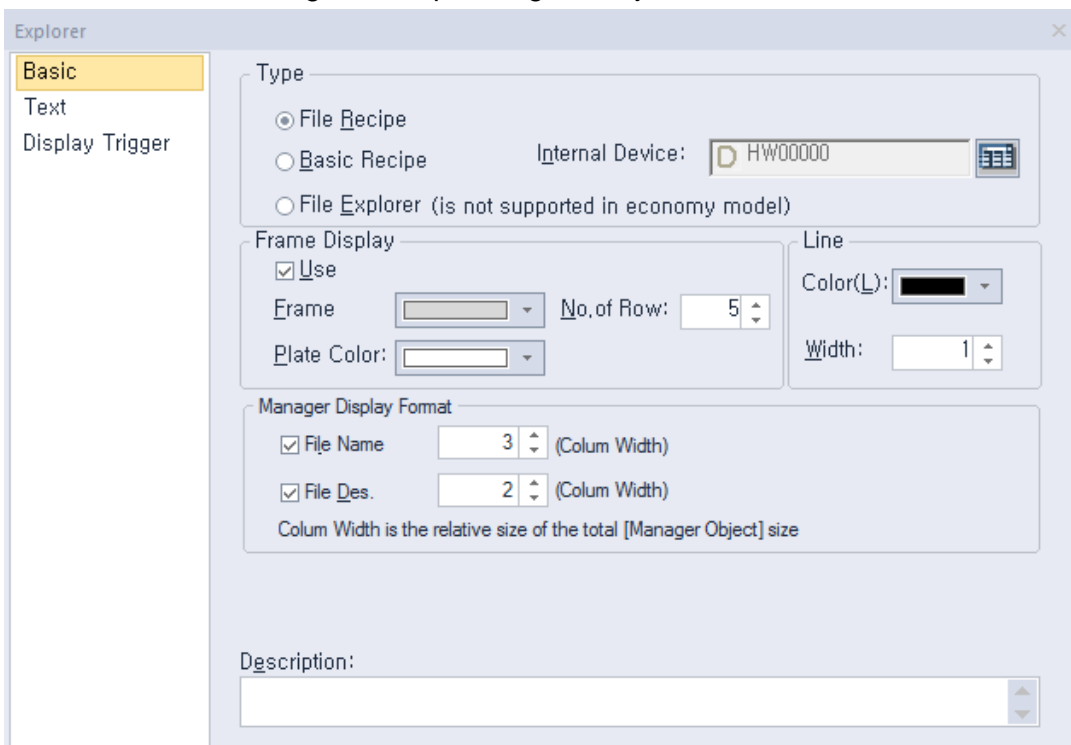

- **Type:** Set the type of recipe to display.

File Recipe	Set to show the XPRXXXXX.csv list in the folder “XP_Recipe” on a storage device, such as a USB drive, CF card, or SD card.
Basic Recipe	Set to show the basic recipe list.
Internal Device	Specify the internal device that is used for transferring edited basic recipes from NVRAM. You should move the basic recipes from NVRAM to the internal device to edit them. For example, if the basic recipe is set in XP-Builder, the value should be moved to the internal device to transfer the device value from the D400 to the PLC or from the PLC to the D400.

No	Device	Data 0
1	D00400	100
2	D00401	101
3	D00402	102
4	D00403	103
5	D00404	104
6	D00405	105
7	D00406	106

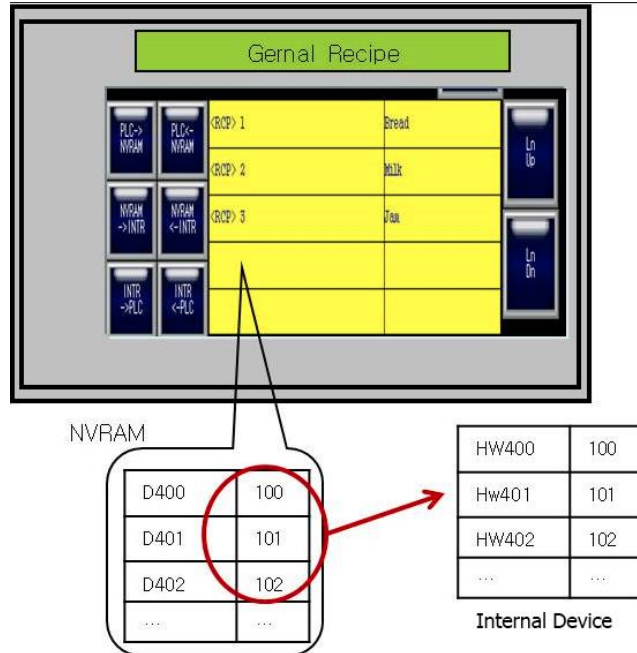

File Explorer

File Explorer displays all the files and the folder lists except for the hidden files and folders that are saved in the storage devices (USB drive, CF Card and SD Card).

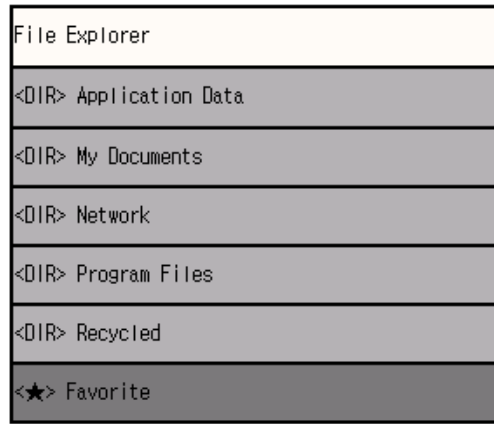

- **Frame Display:** Set whether or not to use a frame.

Frame Color	Select the frame color.
Plate Color	Select the background color for the table.
No. of Col.	Set the number of columns to show.

- **Line:** Set the line properties.
- **Manager Display Format:** Set the data format for the recipe navigator object.

File Name	Set to show the recipe file name. The file recipe displays the name of the CSV file saved in the storage device. The basic recipe displays the data generated in XP-Builder in numerical order. For example, <RCP 1>, <RCP2>, and so on.
------------------	--

File Des. Set to show the recipe description. The description of the file recipe is the title of the CSV file or the name of the basic recipe in XP-Builder.

- **Description:** Enter a description of the object.
- **File Explorer Setting.**

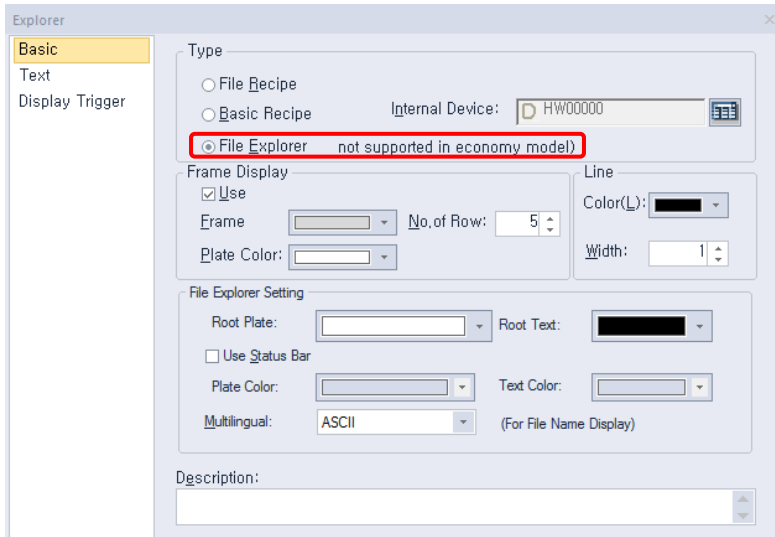

Root Plate

Specify the background color of the section displaying the parent path in File Explorer. Users can navigate between folders or move to the previous directory through the parent path.



Parent Path Display Section

Root Text

Specify the color of the text in the section displaying the parent path in File Explorer.

Use Status Bar

This option sets whether the status bar will be used. The status bar shows the current status of File Explorer. The current action will be displayed as shown in the screenshot below.

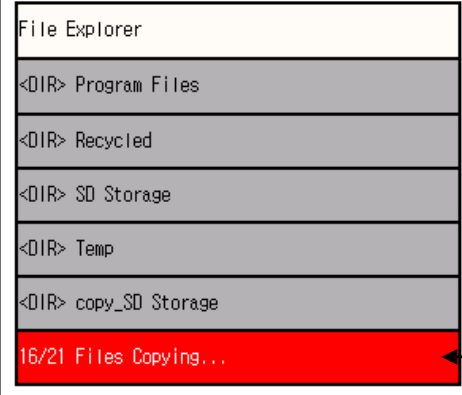
	
Plate Color	Specify the background color of the section displaying the status bar in File Explorer.
Text Color	Specify the text color in the section displaying the status bar in File Explorer.

Note

- If multiple items are selected in File Explorer, the first of the selected items is operated. For example, if <DIR> My Documents is selected and then <DIR> Program Files is also selected and the Copy button is clicked, the files in <DIR> My Documents are copied.
- File Explorer cannot be used with some models. The following models do not provide File Explorer:
XP30-BTE, XP30-TTE, XP40-TTE, XP50-TTE
- Folders and files are displayed in a file recipe as follows.

Directory

To move to the directory, select the row and select Show the Selected Recipe under General Recipe Explorer and Transfer from a special switch.

File Name

To view the file, select the row and select Show the Selected Recipe under General Recipe Explorer and Transfer from a special switch.

<DIR> ..	
KPR00001, CSV	Recipe_00
KPR00002, CSV	Recipe_01
KPR00003, CSV	Recipe_02
KPR00004, CSV	Recipe_03
KPR00005, CSV	Recipe_04

- **Text:** The text settings for recipe navigator objects are shown in the screenshot below.

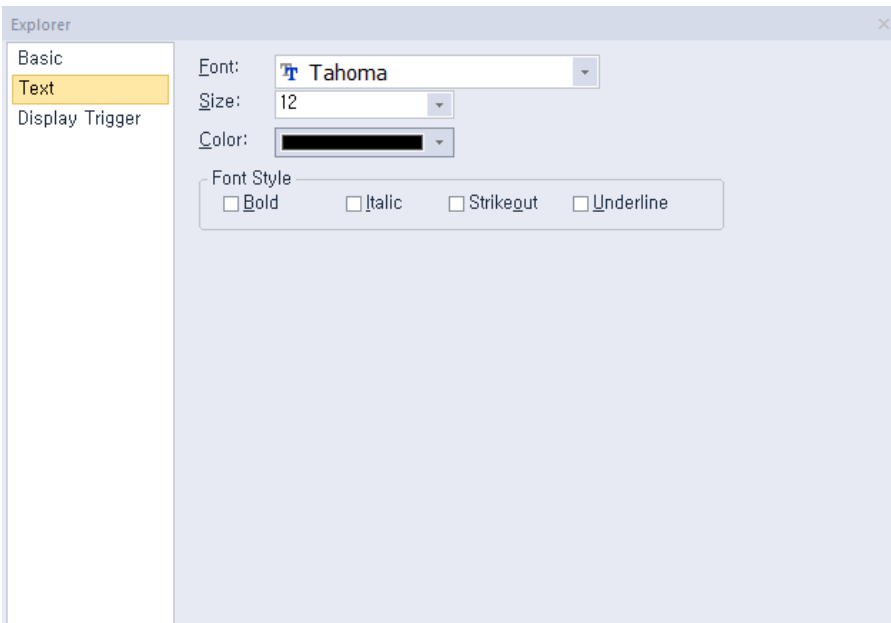

- **Font:** Select a font from the drop-down list.
- **Size:** Select a text size from the drop-down list or enter a value directly into the field.
- **Color:** Select a font color.
- **Font Style:** Select a font style (bold, italic, strikeout, or underline). You can apply more than one option at a time.

- **Display Trigger:** The display trigger settings for recipe navigator objects are shown in the screenshot below.

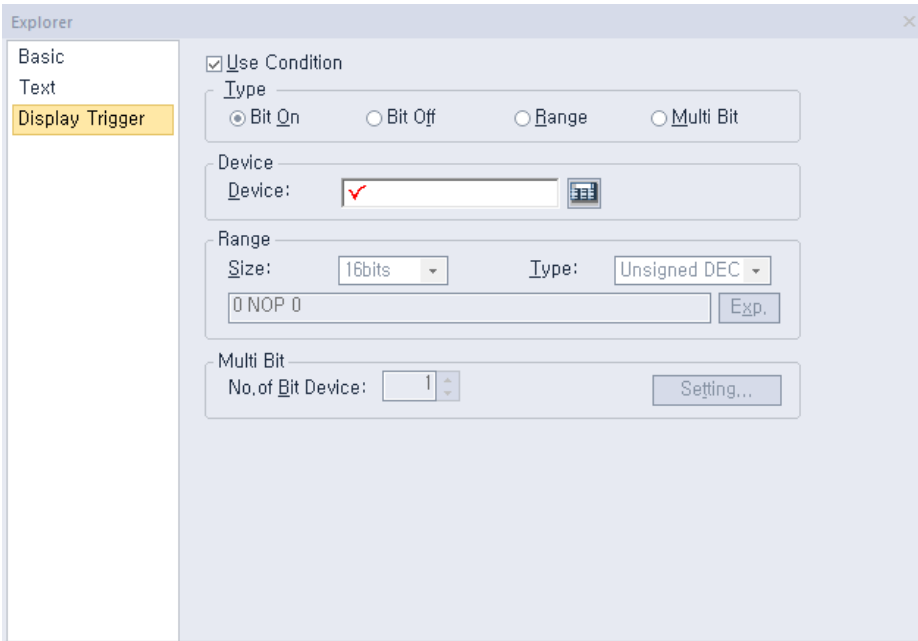

- **Use Action Condition:** Set whether or not to specify a condition for the action.
- **Type:** Set a type of condition to specify.

Bit On	The action is performed when the device is switched on.
Bit Off	The action is performed when the device is switched off.
Range	The action is performed when the value falls within the specified range.
Multi Bit	The action is performed when the logical operation result of multiple devices is met.

- **Device:** Enter a device or tag address directly into the input field or click the keypad icon to the right to specify a device or tag address. When you click the keypad icon to open the Device window, you can also specify network settings, if necessary.
- **Range:** If you select the range condition, specify the range.

Size	16 bit or 32 bit.
Type	Signed decimal, unsigned decimal, BCD, or float.
Exp.	Click to designate the expression as conditional.

- **Multi Bit:** If you select the multi bit condition, specify the number of bits and click [Setting] to specify the bit conditions.

4.3.14 Data List Editor Object

The data list editor object interprets PLC device values continuously and displays them in a table for editing. This section describes available settings for the data list editor object.

- **Basic:** The basic settings for the data list editor objects are shown in the screenshot below.

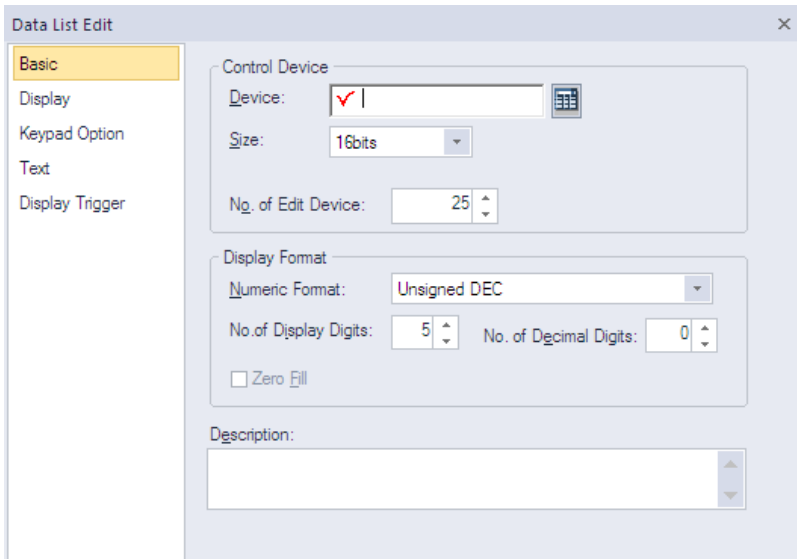

- **Control Device:** Specify a device to monitor values.

Device	Enter a device or tag address directly into the input field or click the keypad icon to the right to specify a device or tag address. When you click the keypad icon to open the Device window you can also specify network settings, if necessary.
Size	Set the data size for the device (16 bit or 32 bit).
No. of Edit Device	Set the number of devices to be shown (up to 255). Clicking a desired cell in a data list editor will open the keypad. Press the Enter key to move the focus of the keypad to the next cell automatically to allow you to edit the value of the next cell. Press the ESC key on the keypad to stop editing.

- **Display Format:** Set the display format.

Numeric Format	Set the number format (signed decimal, unsigned decimal, octal, hexadecimal, and binary, BCD, or float).
No. of Display Digits	Set how many digits to display (up to 64). If the number of digits is less than the capacity of the device, empty spaces are filled with placeholders (“*”). If the device value cannot be displayed in BCD format, it is expressed as “~”.
No. of Decimal Digits	Set how many places to put to the right of the decimal point when you select number formats other than binary, octal, and hexadecimal.
Zero Fill	If you have selected right justification, select this option to insert zeros (0) before the number.

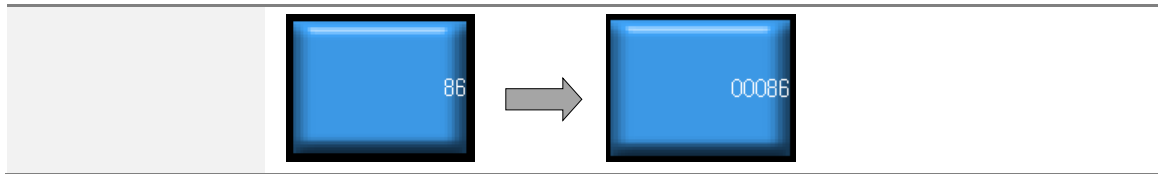

- **Description:** Enter a description of the object.
- **Display:** The display settings for the data list editor objects are shown in the screenshot below.

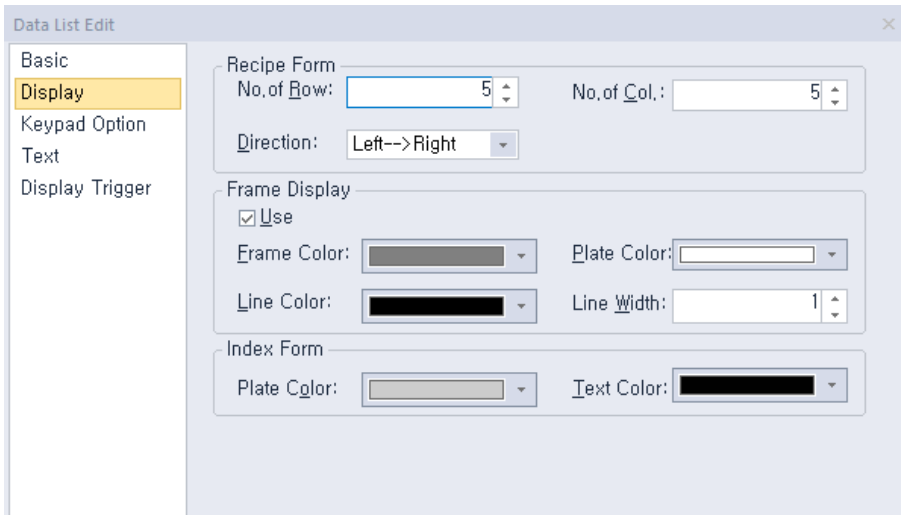

- **Recipe Form:** Set the display options for recipe data.

No. of Row	Set the number of rows to display.
No. of Col.	Set the number of columns to display.
Direction	Set the display direction (top > bottom or left > right).

- **Frame Display:** Set the display options for the frame.

Use	Set whether or not to use a frame.
Frame Color	Select the frame color.
Plate Color	Select the background color.
Line Color	Select the line color.
Line Width	Set the line width.

- **Index Form:** Set the header format for the data list.

Plate Color	Select the background color.
Text Color	Select the text color.

- **Keypad Option:** The keypad option settings for the data list editor objects are shown in the screenshot below.



- **Use Keypad:** Set whether or not to use a keypad.

Use Keypad set in Input Object	Set whether or not to use a keypad specified in an object. Enter the key window number or click [Browse] to locate the window.
Use User Keypad Position	Set whether or not to specify the location of the keypad on the screen.

- **Use Interlock:** Set to prevent input when the interlock device meets the specified condition. The input cursor will skip the locked unit and move automatically to the next unit in the sequence.

Not allowed on ON	When the device is on, input is not allowed.
Not allowed on OFF	When the device is off, input is not allowed.

- **Use Log:** Set to allow the device to be monitored in an operation log. XP30-BTE, XP30-TTE, XP40-TTE, XP50-TTE is not supported.

- **Text:** The text settings for the data list editor objects are shown in the screenshot below.

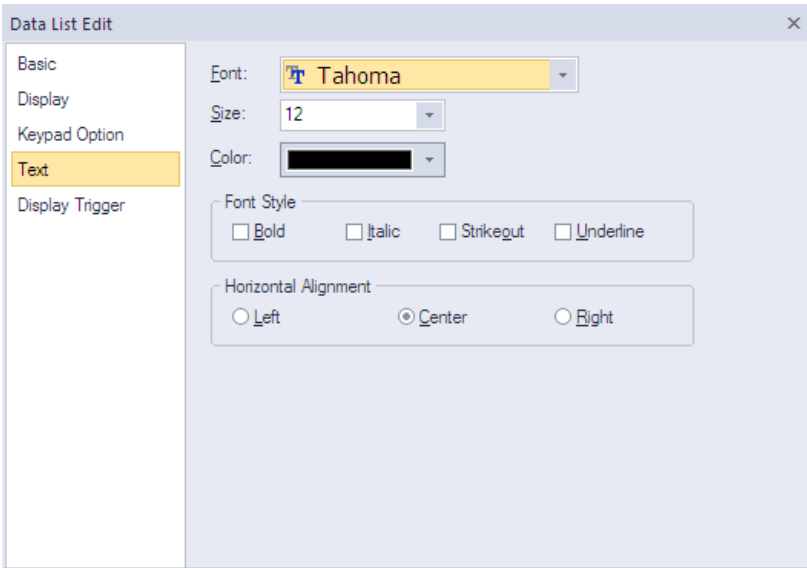

- **Font:** Select a font from the drop-down list.
 - **Size:** Select a text size from the drop-down list or enter a value directly into the field.
 - **Color:** Select a font color.
 - **Font Style:** Select a font style (bold, italic, strikeout, or underline). You can apply more than one option at a time.
 - **Horizontal Alignment:** Set the horizontal alignment (left, center, or right).
- **Display Trigger:** The display trigger settings for the data list editor objects are shown in the screenshot below.

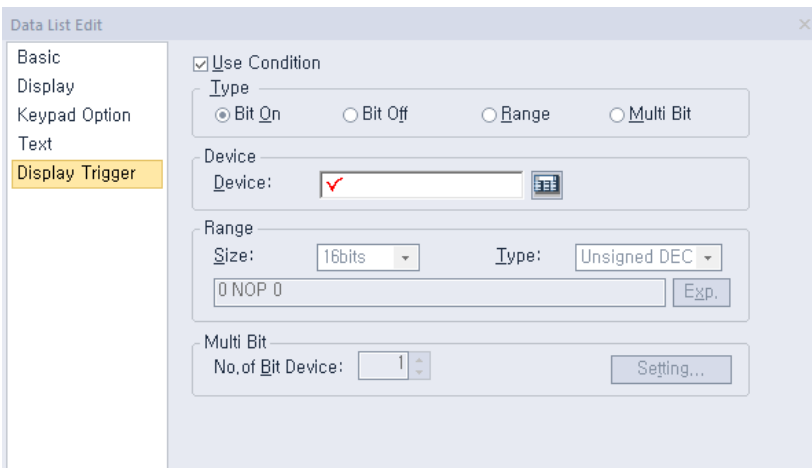

- **Use Action Condition:** Set whether or not to specify a condition for the action.
- **Type:** Set a type of condition to specify.

Bit On	The action is performed when the device is switched on.
Bit Off	The action is performed when the device is switched off.
Range	The action is performed when the value falls within the specified range.

Multi Bit	The action is performed when the logical operation result of multiple devices is met.
------------------	---

- **Device:** Enter a device or tag address directly into the input field or click the keypad icon to the right to specify a device or tag address. When you click the keypad icon to open the Device window, you can also specify network settings, if necessary.
- **Range:** If you select the range condition, specify the range.

Size	16 bit or 32 bit.
Type	Signed decimal, unsigned decimal, BCD, or float.
Exp.	Click to designate the expression as conditional.

- **Multi Bit:** If you select the multi bit condition, specify the number of bits and click [Setting] to specify the bit conditions.

4.3.15 File Recipe Editor Object

The file recipe editor object allows you to view and edit recipes. This section describes available settings for the file recipe editor object.

- **Display:** The display settings for the file recipe editor objects are shown in the screenshot below.

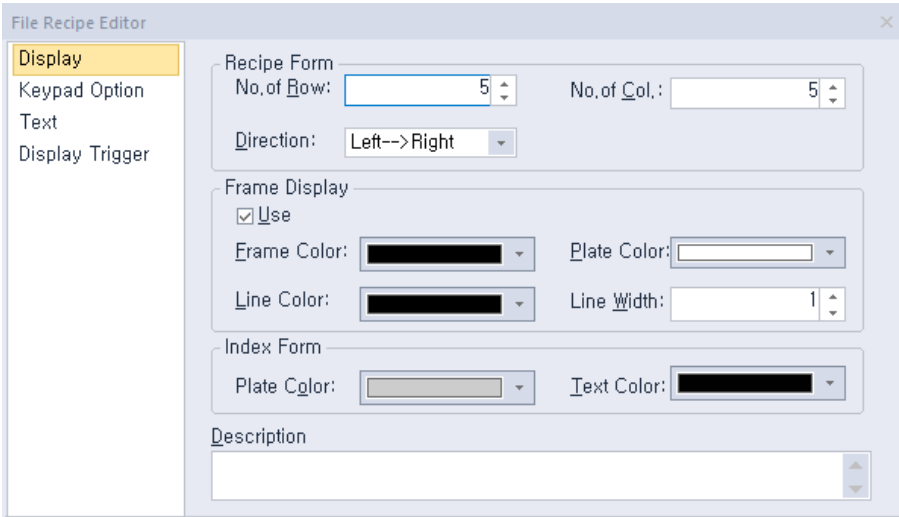

- **Recipe Form:** Set the display options for the recipe data.

No. of Row	Set the number of rows to display.
No. of Col.	Set the number of columns to display.
Direction	Set the display direction (top > bottom or left > right).

- **Frame Display:** Set the display options for the frame.

Use	Set whether or not to use a frame.
Frame Color	Select the frame color.
Plate Color	Select the background color.
Line Color	Select the line color.
Line Width	Set the line width.

- **Index Form:** Set the header format for the data list.

Plate Color	Select the background color.
Text Color	Select the text color.

- **Description:** Enter a description of the object.

- **Keypad Option:** The keypad option settings for the file recipe editor objects are shown in the screenshot below.

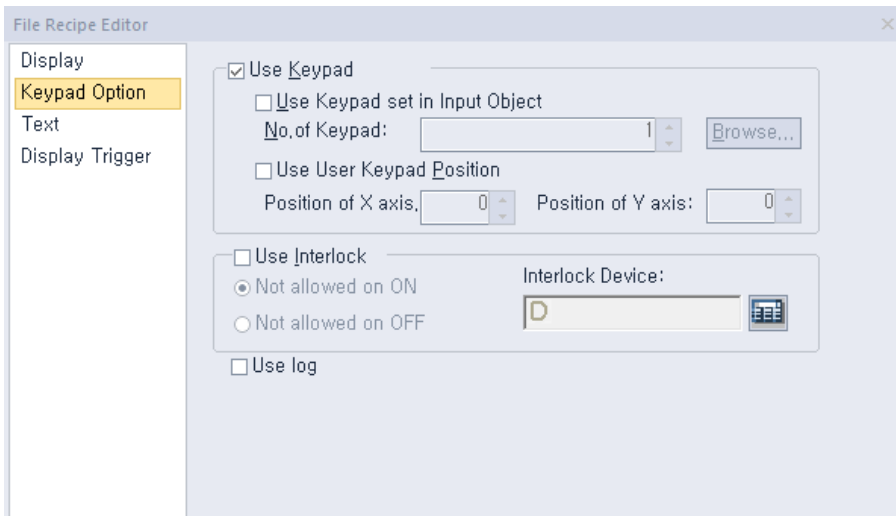

- **Use Keypad:** Set whether or not to use a keypad.

Use Keypad set in Input Object	Set whether or not to use a keypad specified in an object. Enter the key window number or click [Browse] to locate the window.
Use User Keypad Position	Set whether or not to specify the location of the keypad on the screen.

- **Use Interlock:** Set to prevent input when the interlock device meets the specified condition. The input cursor will skip the locked unit and move automatically to the next unit in the sequence.

Not allowed on ON	When the device is on, input is not allowed.
Not allowed on OFF	When the device is off, input is not allowed.

- **Use Log:** Set to allow the device to be monitored in an operation log. XP30-BTE, XP30-TTE, XP40-TTE, XP50-TTE is not supported.

- **Text:** The text settings for the file recipe editor objects are shown in the screenshot below.

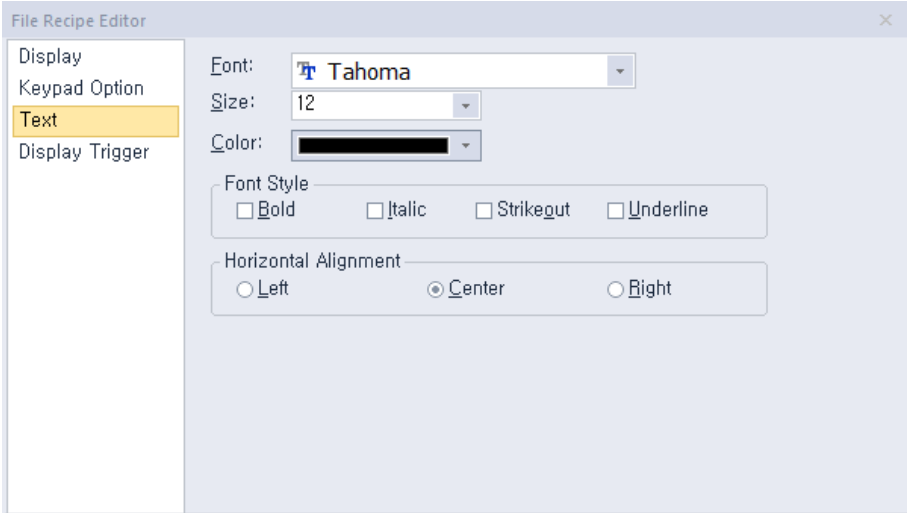

- **Font:** Select a font from the drop-down list.
 - **Size:** Select a text size from the drop-down list or enter a value directly into the field.
 - **Color:** Select a font color.
 - **Font Style:** Select a font style (bold, italic, strikeout, or underline). You can apply more than one option at a time.
 - **Horizontal Alignment:** Set the horizontal alignment (left, center, or right).
- **Display Trigger:** The display trigger settings for the file recipe editor objects are shown in the screenshot below.

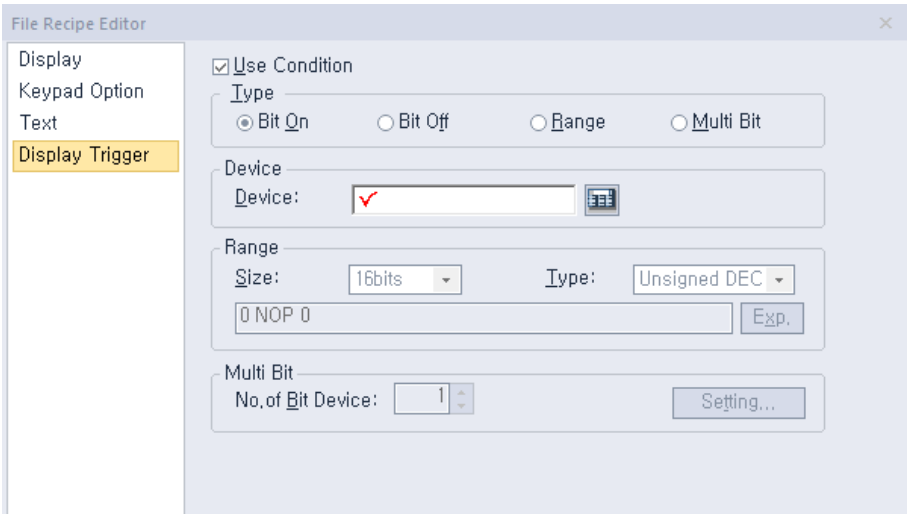

- **Use Condition:** Set whether or not to specify a condition for the action.
- **Type:** Set a type of condition to specify.

Bit On	The action is performed when the device is switched on.
Bit Off	The action is performed when the device is switched off.
Range	The action is performed when the value falls within the specified range.
Multi Bit	The action is performed when the logical operation result of

multiple devices is met.

- **Device:** Enter a device or tag address directly into the input field or click the keypad icon to the right to specify a device or tag address. When you click the keypad icon to open the Device window, you can also specify network settings, if necessary.
- **Range:** If you select the range condition, specify the range. Constants are based on device size.

Size	16 bit or 32 bit.
Type	Signed decimal, unsigned decimal, BCD, or float.
Exp.	Click to designate the expression as conditional.

- **Multi Bit:** If you select the multi bit condition, specify the number of bits and click [Setting] to specify the bit conditions.

4.3.16 Clock Object

This section describes available settings for the clock object.



- **Basic:** The basic settings for the clock objects are shown in the screenshot below.

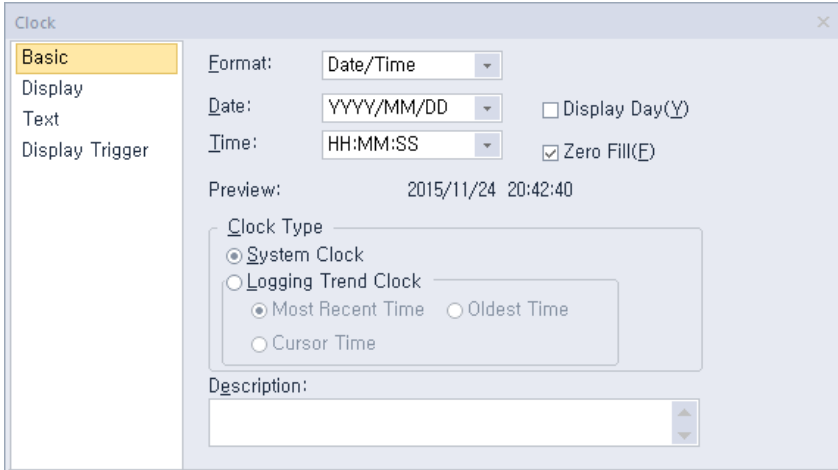

- **Format:** Set the data format.

Item	Description
Date/Time	Date and time
Date	Date
Time	Time

- **Date:** Set the date format.

Item	Description
YYYY/MM/DD	Year/Month Number/Date (4-digit year)
YY/MM/DD	Year/Month Number/Date (2-digit year)
MM/DD/YYYY	Month Number/Date/Year (4-digit year)
MM/DD	Month Number /Date
MM/DD/YY	Month Number /Date/Year (2-digit year)
DD/MM/YYYY	Date/Month Number /Year (4-digit year)
DD/MM/YY	Date/Month Number /Year (2-digit year)
DD/MMM/YYYY	Date/Month Name/Year (4-digit year)
DD/MMM/YY	Date/Month Name/Year (2-digit year)

- **Time:** Set the time format.

Item	Description
------	-------------

Item	Description
HH:MM:SS	Hour:Minute:Second
HH:MM	Hour:Minute

- **Display Day:** Set whether or not to show the day of the week.
- **Zero Fill:** If the date or time includes a single digit number, select this option to insert a zero before the number. For example,
23/3/2010 15:15:3 ► 23/03/2010 15:15:03
- **Preview:** Shows a preview of the data format.
- **Clock Type:** Set a clock type.

System Clock	Set to show the system time in the clock.
Logging Trend Clock	Set to show logging data in the clock. Set a logging trend option (most recent time, oldest time, or cursor time). If a logging trend object does not exist in a screen, "-" will be displayed in the time format because the time cannot be displayed.

- **Description:** Enter a description of the object.
- **Display:** The display settings for the clock objects are shown in the screenshot below.

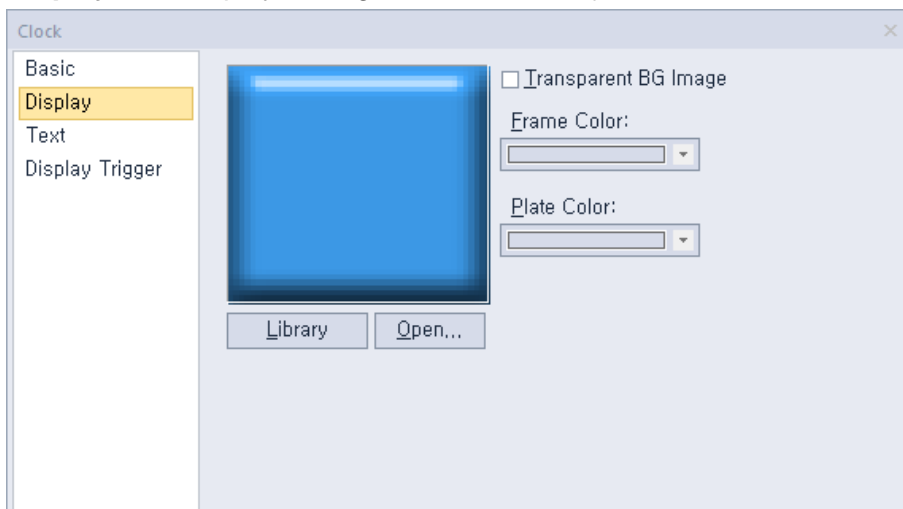

- **Library:** Click to select an image from an image library.
- **Open:** Click to browse images on your computer. When you select an image from your computer, it will be added to the image library automatically.
- **Transparent BG Image:** Set whether or not to make the background transparent.
- **Frame Color:** Select a frame color (only available with vector images).
- **Plate Color:** Select a background color from the image.

- **Text:** The text settings for the clock objects are shown in the screenshot below.

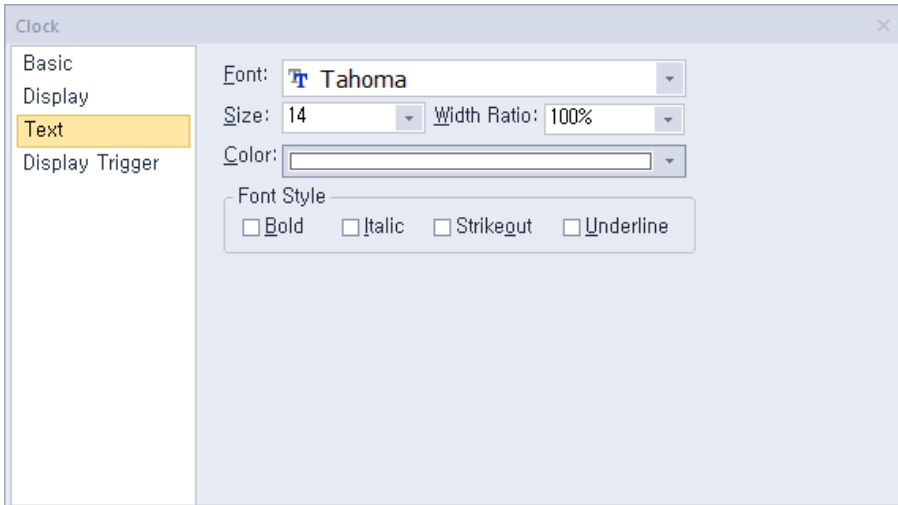

- **Font:** Select a font from the drop-down list.
- **Size:** Select a text size from the drop-down list or enter a value directly into the field.
- **Width Ratio:** Expand or condense the text by selecting a ratio from the drop-down list or entering a value directly in to the field. You can set a ratio of 1%-600%.
- **Color:** Select a font color.
- **Font Style:** Select a font style (bold, italic, strikeout, or underline). You can apply more than one option at a time.

- **Display Trigger:** The display trigger settings for the clock objects are shown in the screenshot below.

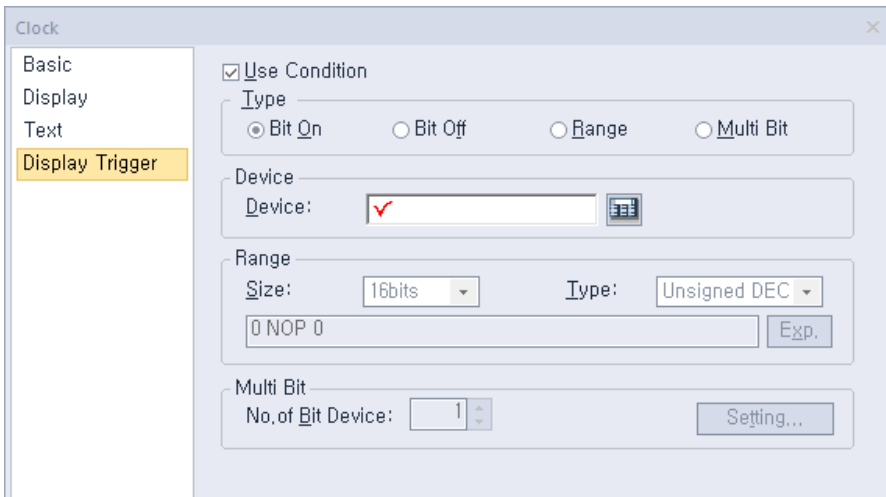

- **Use Condition:** Set whether or not to specify a condition for the action.
- **Type:** Set a type of condition to specify.

Bit On	The action is performed when the device is switched on.
Bit Off	The action is performed when the device is switched off.
Range	The action is performed when the value falls within the specified range.
Multi Bit	The action is performed when the logical operation result of multiple

devices is met.

- **Device:** Enter a device or tag address directly into the input field or click the keypad icon to the right to specify a device or tag address. When you click the keypad icon to open the Device window, you can also specify network settings, if necessary.
- **Range:** If you select the range condition, specify the range. Constants are based on the device size.

Size	16 bit or 32 bit.
Type	Signed decimal, unsigned decimal, BCD, or float.
Exp.	Click to designate the expression as conditional.

- **Multi Bit:** If you select the multi bit condition, specify the number of bits and click [Setting] to specify the bit conditions.

4.3.17 Embedded Screen Object

You can use the embedded screen object to open other screens on the Base screen. You can insert a frequently-used page without additional editing through this object. This section describes available settings for embedded screen object.

To embed a screen into the Base screen, in the Project pane, drag and drop a window (Base screen, window, or Part screen) onto the editing area.

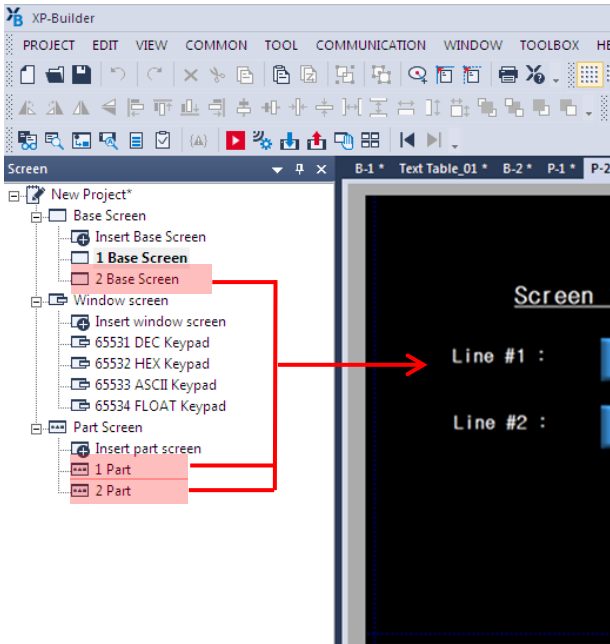

The window will be embedded as follows:

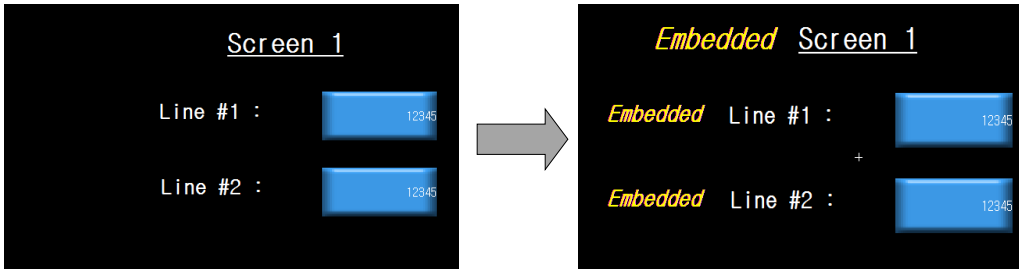

- **Basic:** Basic settings for the embedded screen object include the following. After selecting the base screen or window screen to be inserted, drag and drop it on the target screen and double-click to display the following window.

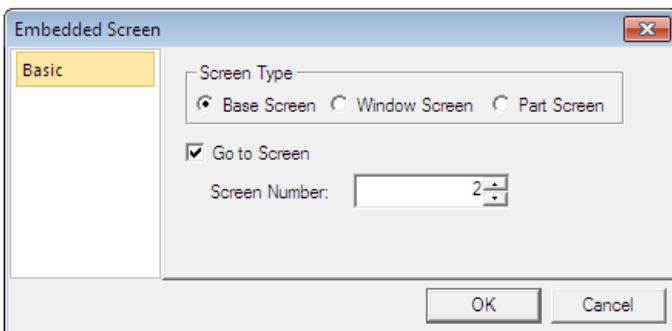

- **Screen Type:** Set the type of screen to be opened.

- **Go to screen:** Set whether or not to open an existing screen.
- **Screen Number:** Set the screen number to open.

Inserting a screen to use an object as the background of another screen, follow the steps below. For example, to insert the "B2" screen as the background on the "B1" screen, open the B1 screen and insert Select the screen (B2) and right-click it.

Settings' menu. As a result, the screen of B2 is displayed in the form of an insert object,

It will be created and inserted in the future. At this time, the screen insertion object has a selection lock. It will be in the state and cannot be selected. To unlock the selection, press the "Unlock Selected" menu it's possible

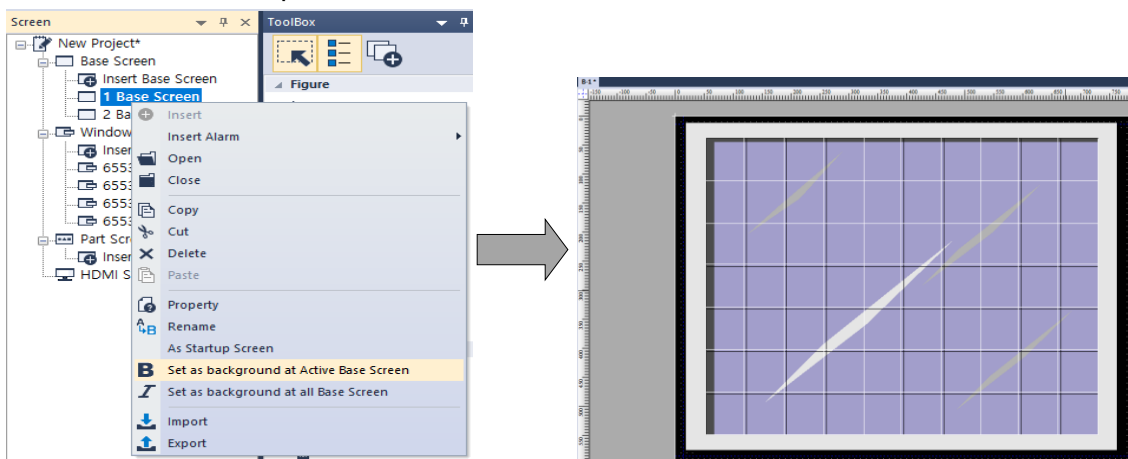

Inserting a Screen To use an object as a background on all other main screens, do the following: For example, to insert "B2" screen as background in all basic screens, select the screen (B2) to insert and then right-click and select "Set as background screen of all basic screens". As a result, the screen of B2 is inserted in the form of an inserted object on all the basic screens except B2, and is created at the top of the screen. At this time, the selection objects can not be selected because the selection lock is applied. To unlock the selection, press the "Unlock" menu.

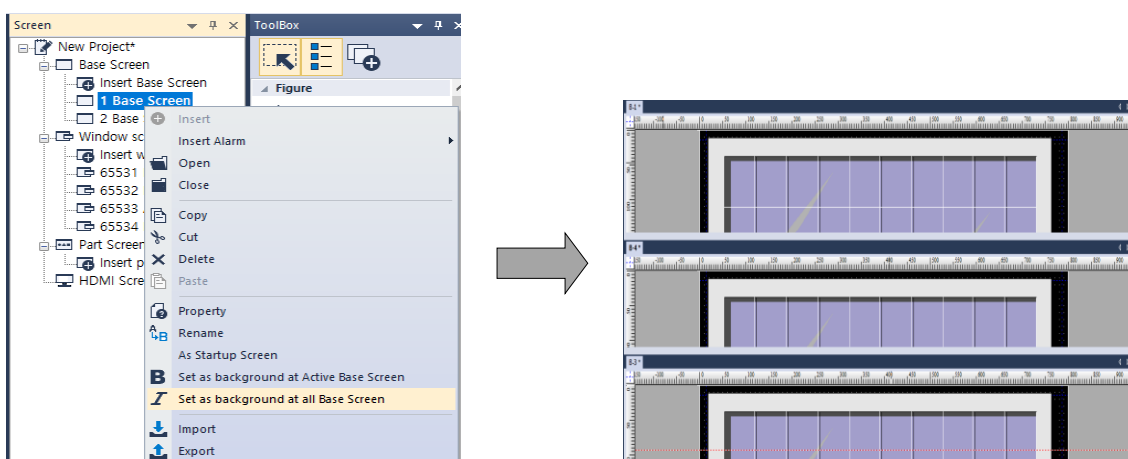



Note

- When you insert a Base screen into another Base screen:
 - Background settings will not be applied.
 - Set scripts cannot be used.

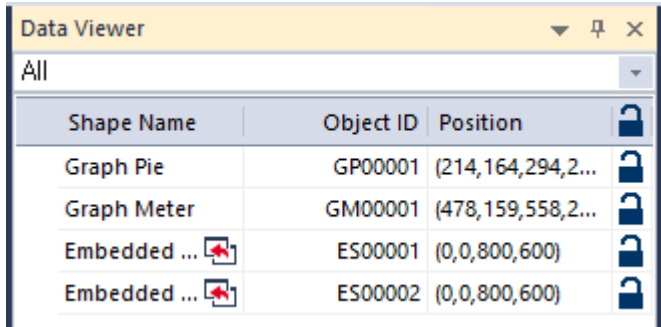
- The inserted Base screen cannot be imported from another Base screen to itself.
- The same number Base screen cannot be inserted.
- You can also insert the Base screen into another Base screen by dragging it.
- When you try to insert a Base screen that is already embedded in another Base screen, the embedded screen is not inserted. Only the Base screen itself is inserted.
- If you click the insert screen move icon in the Data Viewer window, you can move to the corresponding insert screen without needing to release the lock status.



The screenshot shows a window titled "Data Viewer" with a dropdown menu set to "All". Below the menu is a table with four columns: "Shape Name", "Object ID", "Position", and a lock icon. The table contains four rows of data.

Shape Name	Object ID	Position	Lock Icon
Graph Pie	GP00001	(214,164,294,2...	🔒
Graph Meter	GM00001	(478,159,558,2...	🔒
Embedded ... 	ES00001	(0,0,800,600)	🔒
Embedded ... 	ES00002	(0,0,800,600)	🔒

4.3.18 Memo Pad Object

This section describes available settings for the memo pad object.

- **Basic:** The basic settings for the memo pad object include the following.

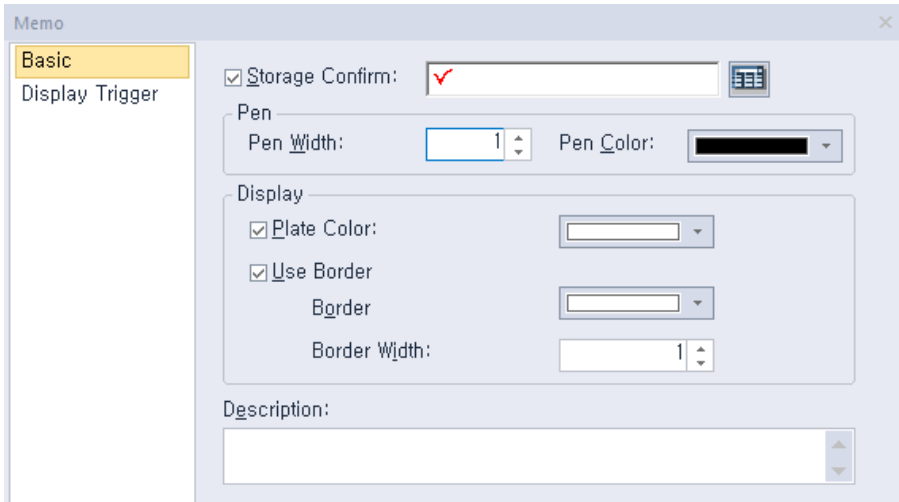

- **Storage Confirm:** Set whether or not to use a device to view current memo status. Enter the device address in the field or click the icon to the right of the field to specify a device address. The first three bits of the device address specify the function of the memo pad.

Device Bit	Description
00	Indicates the status of the object (on in active mode; off in non-active mode).
01	Shows whether or not the memo was saved successfully. The Saving function of a special switch saves a memo currently on the XGT Panel.
02	Shows whether or not the memo was deleted successfully. The Deleting function of a special switch deletes a memo currently on the XGT Panel.

- **Pen:** Set the pen options.

Pen Width	Set the pen width (1 to 30).
Pen Color	Set the pen color.

- **Display:** Set the display options.

Plate Color	Set the background color of the memo pad.
Use Border	Set whether or not to use a border.
Border Color	Set the border color.
Border Width	Set the border width.

- **Description:** Enter a description for the object.

- **Display Trigger:** The display trigger settings for the memo pad object include the following.

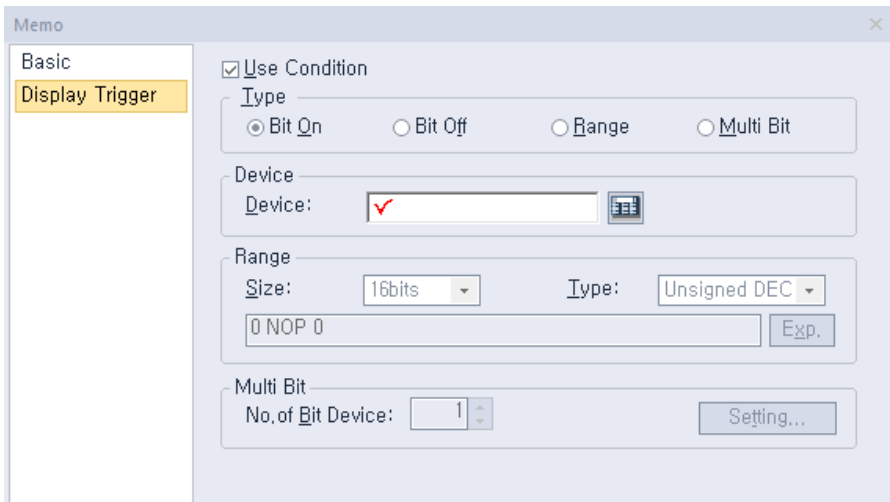

- **Use Condition:** Set whether or not to specify a condition for the action.
- **Type:** Set a type of condition to specify.

Bit On	The action is performed when the device is switched on.
Bit Off	The action is performed when the device is switched off.
Range	The action is performed when the value falls within the specified range.
Multi Bit	The action is performed when the logical operation result of multiple devices is met.

- **Device:** Enter a device or tag address directly into the input field or click the keypad icon to the right to specify a device or tag address. When you click the keypad icon to open the Device window, you can also specify network settings, if necessary.
- **Range:** If you select the range condition, specify the range. Constants are based on device size.

Size	16 bit or 32 bit.
Type	Signed decimal, unsigned decimal, BCD, or float.
Exp.	Click to designate the expression as conditional.

- **Multi Bit:** If you select the multi bit condition, specify the number of bits and click [Setting] to specify the bit conditions.

4.3.19 PDF Viewer Object

This section describes available settings for the PDF viewer object.

You can either use File Explorer to search for a PDF file and open it in the PDF viewer object on the screen, or configure a special switch for PDF viewing. Refer to the PDF viewer section in **<4.3.2.4 Special Switch>** for detailed information.

- **Basic:** The basic settings for the PDF viewer object include the following.

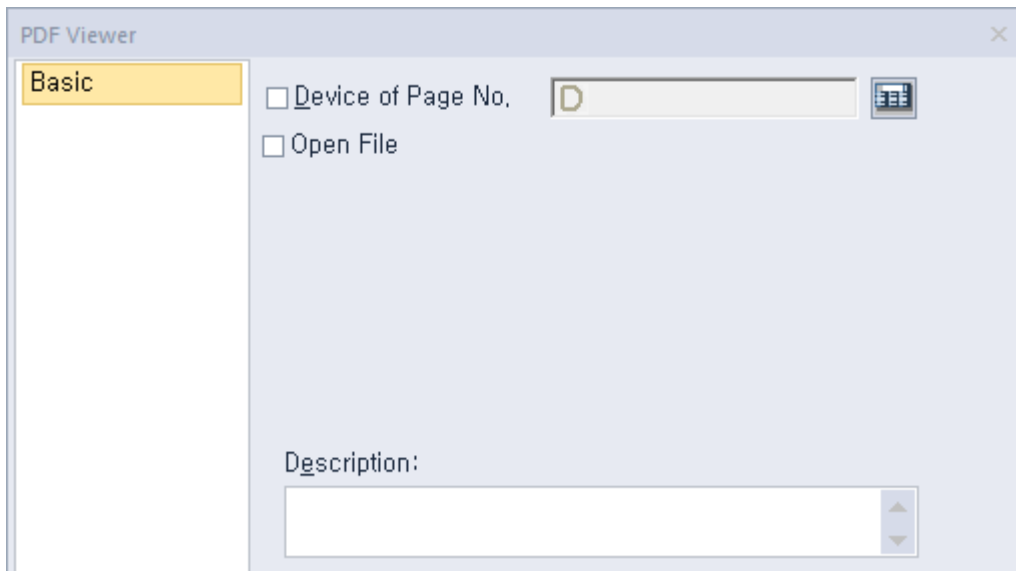

- **Device of page No.:** Set a device to assign the page number of a PDF file that is currently open.
- **Open File:** Set whether to open a PDF file using a file path, or a device.

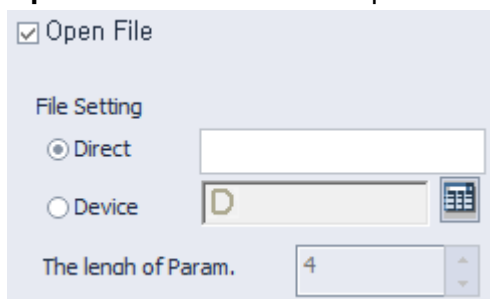

- **Description:** Enter a description for the object.

Note

- You can place only one PDF viewer on a screen.
- PDF viewer function is not supported in the simulator.
- The PDF document is displayed to fit the width of the object. You can scroll down to see the rest of the document outside the viewing area.

4.3.20 VNC Viewer Object

This section describes available settings for the VNC viewer object.

You can remotely monitor the host computer's screen using the VNC viewer. Refer to the VNC viewer section in **<4.3.2.4 Special Switch>** for detailed information.

- **VNC Viewer:** The basic settings for the VNC viewer object include the following.

- **Remote:** Enter the host name of the remotely connected HMI device for monitoring.
- **Port:** Enter the TCP/IP port number to use for the monitoring.
- **Use password:** Click the checkbox to set a password for the monitoring operation.
- **Option:** Set the following options.
- **Use Popup Window:** Select this option to display the remote screen in a popup window.
- **Disable Touch Inputs:** Select to disable touch inputs for the remote screen.
- **Description:** Enter a description for the object.

- **Display Trigger:** The display trigger settings for the VNC viewer object include the following.

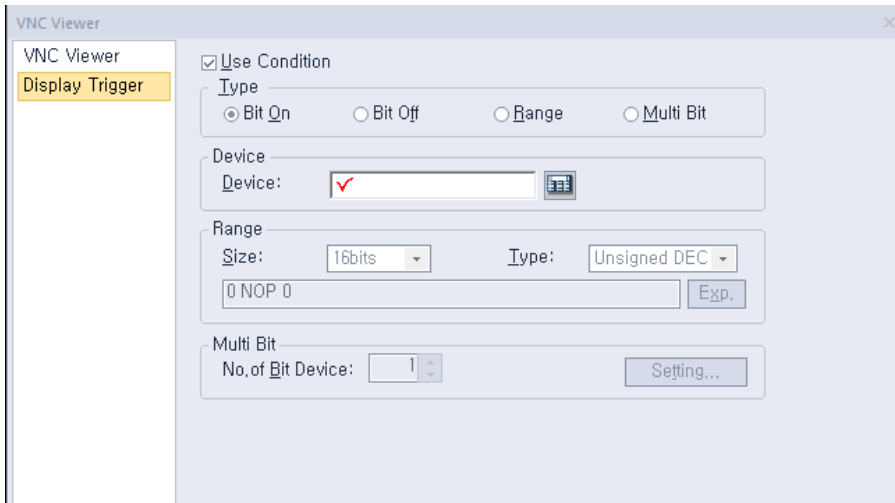

- **Use Condition:** Set whether or not to specify a condition for the action.
- **Type:** Set a type of condition to specify.

Bit On	The action is performed when the device is switched on.
Bit Off	The action is performed when the device is switched off.
Range	The action is performed when the value falls within the specified range.
Multi Bit	The action is performed when the logical operation result of multiple devices is met.

- **Device:** Enter a device or tag address directly into the input field or click the keypad icon to the right to specify a device or tag address. When you click the keypad icon to open the Device window, you can also specify network settings, if necessary.
- **Range:** If you select the range condition, specify the range. Constants are based on device size.

Size	16 bit or 32 bit.
Type	Signed decimal, unsigned decimal, BCD, or float.
Exp.	Click to designate the expression as conditional.

- **Multi Bit:** If you select the multi bit condition, specify the number of bits and click [Setting] to specify the bit conditions.

Note

- You can place only one VNC viewer on a screen.
- PDF viewer function is not supported in the simulator.

4.3.21 Multimedia object

This section describes multimedia objects. You can play the video file using multimedia objects. For

more information, please refer to <4.3.2.4 Special Switch>.

- **Multimedia:** This is the Basic setting of multimedia objects.

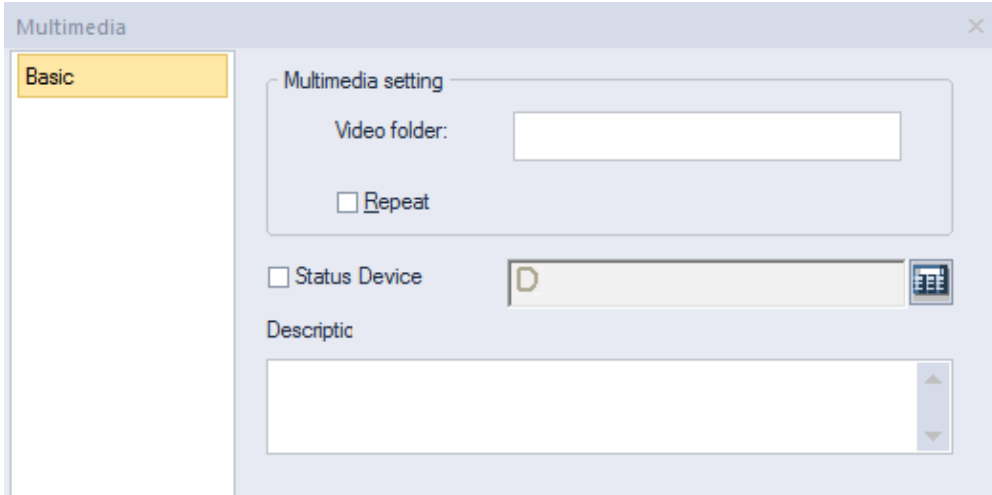

- **Video folder:** Enter the folder name where the video file is located.
- **Repeat:** Set the video file to repeat playback.
- **Status Device:** Enter the device value to read the current status value of the multimedia object.

Status Device Value	Description
0	Normal
1	No external Storage
2	File Open Error
4	Movie File Play Error
8	Movie Play Finished
3, 5, 6, 7, 9~16	Reserved

- **Description:** Enter the description of the object.

Multimedia objects have the below restrictions.

Item	Description
Video File	Supports MP4, AVI, and WMW files.
HDMI Extended Screen (iXP2 only)	Not support video play on HDMI extended screen.
Play Speed	High-quality, high-capacity videos can take a long time to load or may break when playing. For iXP2 model, the 1024 x 768 resolution is recommended.
Number of multimedia object	Only 1 multimedia object can be created in each screen and window.
Video Play	Video play is only possible in one place. The currently playing video will stop when playing a video through a multimedia object on a popup window while playing a video

on the main screen.

Note

- Multimedia object can be used only in wXP and iXP2.
 - If the video cannot be played, take the following measures.
 - iXP2
Play after encoding video file set as below through video encoding program.
 - iXP2-08XXA model
Resolution: 800 x 600, Codec: H264
 - Other iXP2 models
Resolution: 1024 x 768, Codec: H264
 - wXP
 - Please install the external video integrated codec on the PC where wXP is installed.
-

4.3.22 FTP Client

The FTP client is an object that connects to an FTP server, displays a list of files and directories on the FTP server, and downloads selected files. PDF files on an FTP server can be displayed using a PDF viewer object. FTP client object is available only for iXP2 and iXP models.

- **Basic:** FTP client basic setting.

- **FTP Server:** Enter the IP address of the FTP server to connect to. The FTP server address can be used by entering a fixed value or by using a device.
- **Port number:** Enter the FTP server port to connect to. The default port number is 21. The port number can be changed by entering a fixed value or using a device.
- **User ID:** Enter the User ID of the FTP server to connect to. If anonymous mode connection is used, the ID is set to anonymous. The ID can be changed by entering a fixed value or by using a device.
- **Password:** Enter the password of the FTP server account to access. The password can be changed by entering a fixed value or by using the device.
- **FTP server anonymous mode connection:** Connect to the FTP server using the Anonymous account. The ID is disabled so that it cannot be changed.
- **Use Passive Mode:** When set, accesses in passive mode.
- **FTP server charset settings:** Set the character set of the FTP server. The default value is UTF-8.

Note

- If the set character set is different from the character set on the server, it may happen that the

Korean display is not normally performed.

- When connecting to an FTP server running on iXP2/eXP2, the file and folder names may not be displayed in Korean.

- **Status Device:** Set the device that records the value to display the operation status of the FTP client .

0	Default value
1	IP address is incorrect.
2	FTP server connection success
3	FTP server connection failure
4	File download success
5	File download failure.
6	FTP server connection termination.

- **Description:** Enter the description of the object.

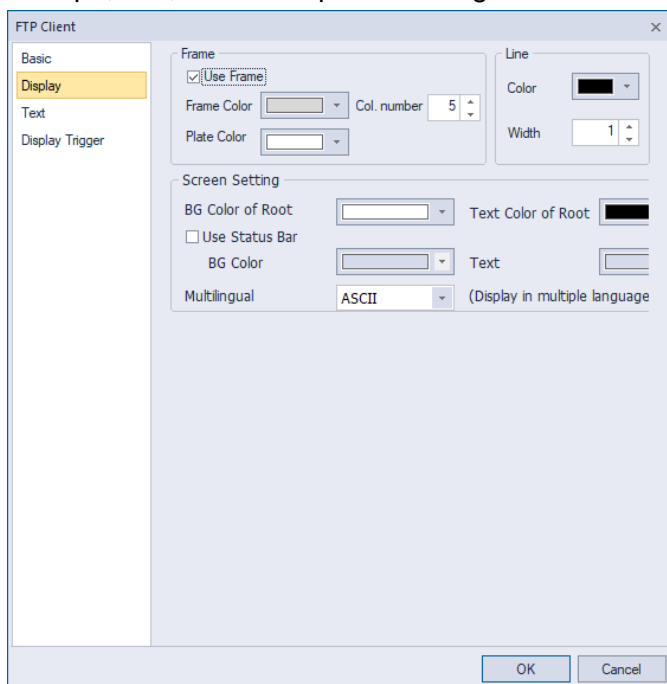

- **Display:** This is the screen for setting the FTP client display. This is the same as the file explorer's frame shape, line, and file explorer settings.



- **Use Frame:** Select whether to use the frame.

Frame Color	Set frame color
Plate Color	Set plate color of FTP client.
Col.number	Set the number of rows to be displayed on the screen.

- **Line:** Set the line color and width.

<p>BG Color of Root</p>	<p>Specifies the background color of the area that displays the parent path on FTP clients. You can go to the previous folder or previous directory through the parent path.</p>  <p>Parent path display area</p>
<p>Text Color of Root</p>	<p>Specifies the text color of the area that parent path in the FTP client.</p>
<p>Use Status Bar</p>	<p>Enable or disable the status bar. The status bar displays the current FTP client's operational connection status and the server address to which it is connected.</p>  <p>Display status</p>
<p>BG Color</p>	<p>Specifies the background color of the area where the FTP client displays the status bar.</p>
<p>Text</p>	<p>Specifies the text color of the area that displays the status bar on the FTP client.</p>

Note

- If multiple cells are selected in the FTP client, the cell selected first operates. For example, if you select A.PDF, B.PDF in order, and then press the Execute special switch, the selected A.PDF file is displayed in the PDF viewer first.

- **Text:** Set the text for FTP Client. It is the same as the character setting function of File Explorer.

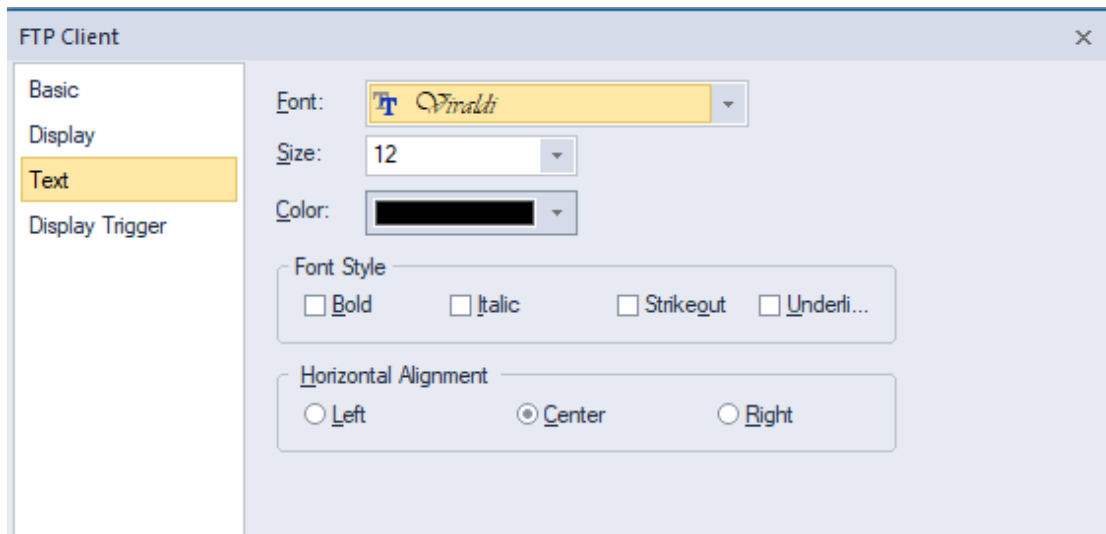

- **Font:** Select the font.
- **Size:** Select the font size.
- **Color:** Set the text color
- **Font style:** Set the text style. Bold, italic, strikeout, underline). 2 or more can be selected.

- **Display trigger:** Sets the display trigger for the FTP Client. This is the same as the display trigger setting function of File Explorer.

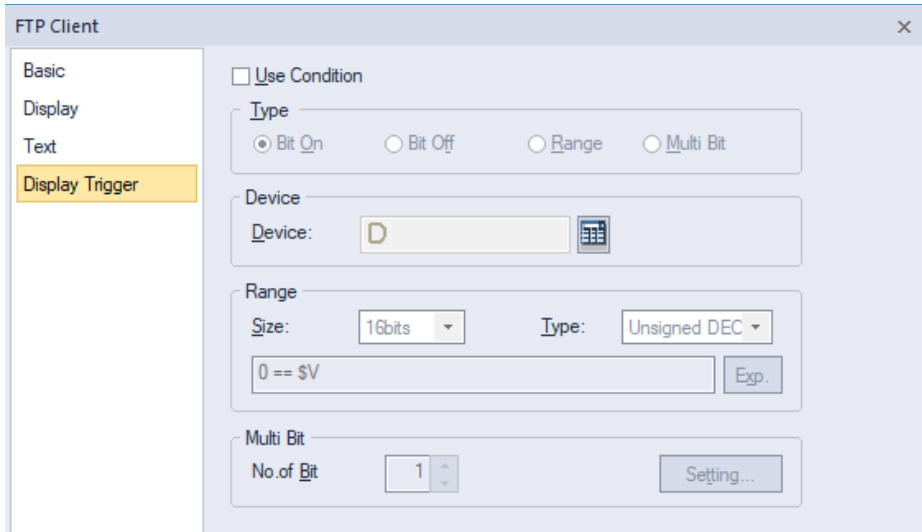

- **Use Condition:** Select whether to use the display trigger.
- **Type:** Set the type of the condition.

Bit On	Displayed when the device is on
Bit Off	Displayed when the device is off
Range	Displayed when the value is included in the set area
Multi Bit	It operates when the result of multiple devices satisfies the logical command.
- **Device:** Enter the device or tag address directly in the input area or use the keypad buttons. Network settings are also possible when you press the keypad button to open the device window.
- **Range:** If you select the range condition, specify the range.

Size	16 bit or 32 bit.
Type	Signed decimal, unsigned decimal, BCD, or Float
Exp.	Click to designate the expression as conditional.
- **Multi Bit:** If you select the multi bit condition, specify the number of bits and click [Setting] to specify the bit conditions.

Note

- If connection to the FTP server fails, check the following.
 - Check if the FTP server IP address is correctly entered and connected to the network by ping test.
 - Check if the entered ID and password are correct
 - When connecting with an anonymous account, you must enter a password according to the FTP server settings. Please enter your email address in the password.
- If Korean file and directory names are not displayed, check the following.
 - The character set must be set to match that of the FTP server.
 - If you cannot check the character set of the FTP server, change the UTF-8 and CP949 and reconnect.

4.3.23 Slider

Description of the slider control object.

[Name of the slider control object item]

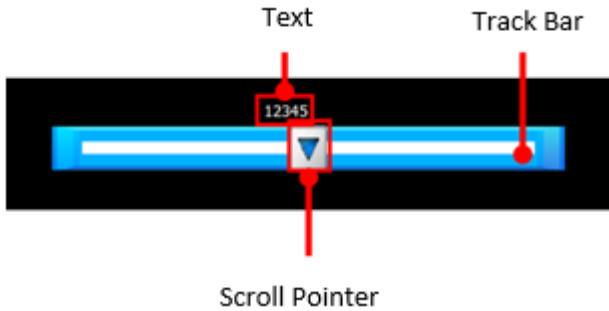

- **Basic:** This is the basic setting for the slider control object.

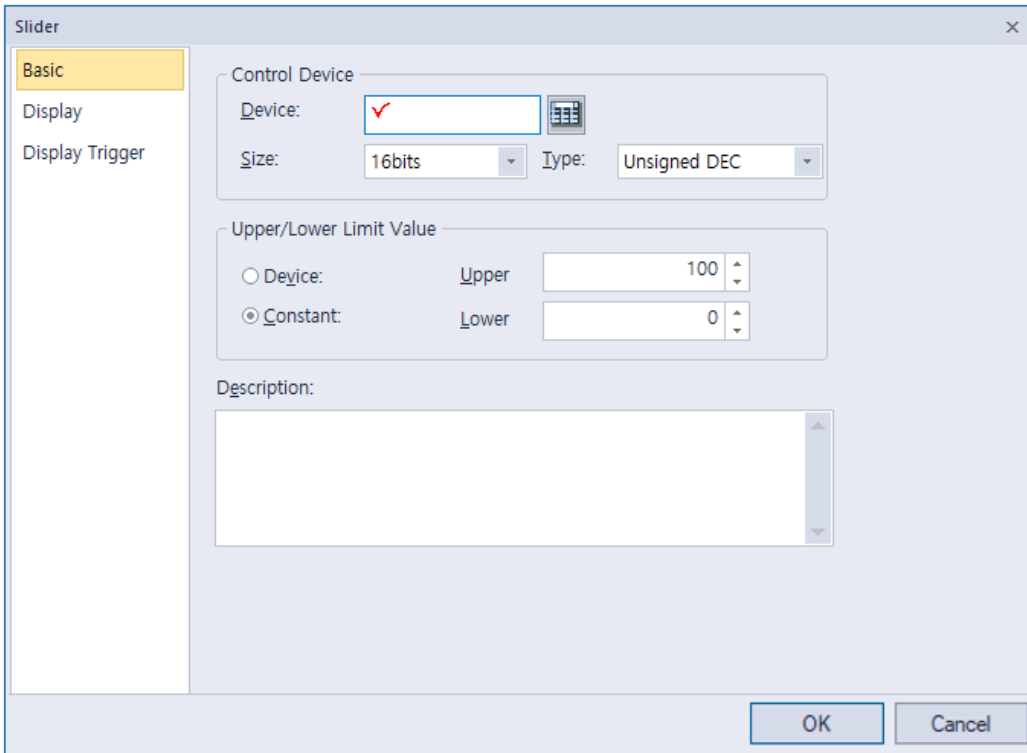

- **Control Device:** Set options for the control device.

Device	Directly enter the device or tag address in the input area, or click the keyboard button on the right to set. In case of setting through the keyboard, network setting is also possible if necessary.
Size	Set the device data size (16-bit or 32-bit).
Type	Set the data type of the device (signed decimal, unsigned decimal, BCD).

- **Upper/Lower:** Set the upper/lower value of the data to be displayed. The upper/lower values should be set within the range supported by the device type. If it is out of range, the lower or upper value supported by the device is displayed.

Device	Set the specified device value as the upper and lower values.
Constant	Set a fixed value specified by the user as the upper and lower values.

Note

- Refer to the table below for the upper and lower fixed value depending on the device size:

Device size	Device type	Lower Value	Upper Value
16bit	Signed decimal	-32768	32767
16bit	Unsigned decimal	0	65535
16bit	BCD	0	9999
32bit	Signed decimal	-2147483648	2147483647
32bit	Unsigned decimal	0	4294967295
32bit	BCD	0	99999999

- **Description:** Enter a description of the object.

- **Display:** The display setting for the slider control

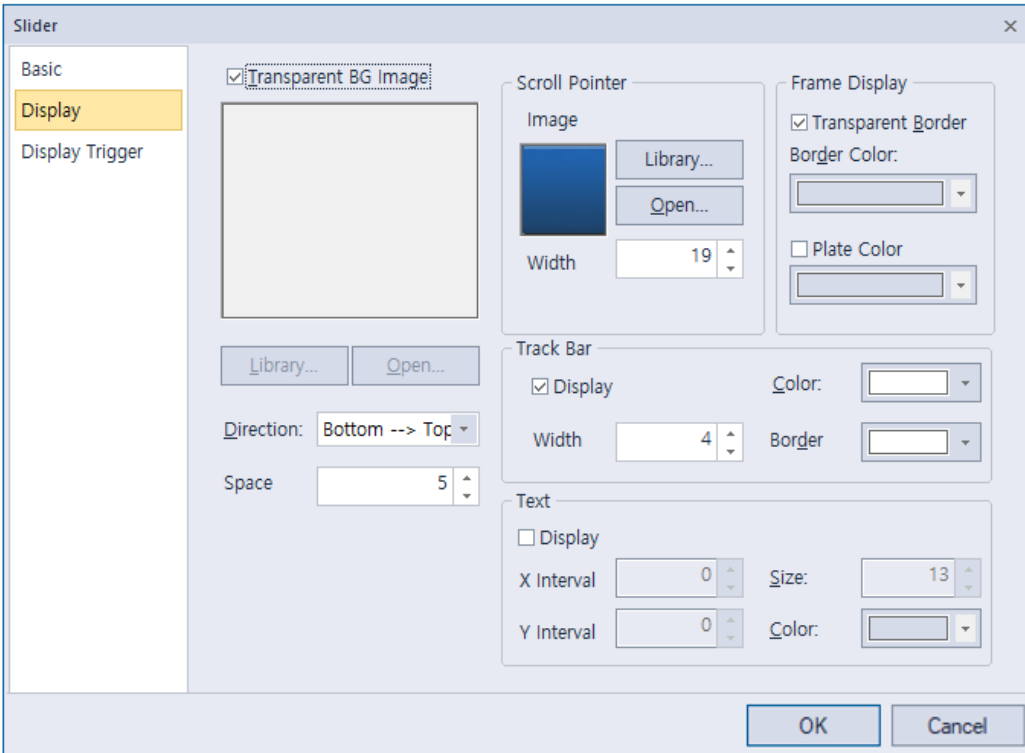

- **Transparent BG Image:** Set whether to display the bar graph background image.
- **Library:** Select the background image from the library.
- **Open:** Select background image to be displayed on the graph on your computer.
- **Direction:** Set the direction to move the slider control (Up to Down, Down to Up, Left to Right, Right to Left)
- **Space:** Set the space of the slider control.
- **Scroll Pointer:** Set options for the scroll pointer.

Image	Displays the image of the scroll pointer.
Library	Select the scroll pointer imager from the library
Open	Select the scroll pointer image on your computer
Width	Set the width.

- **Frame Display:** Set options for the scroll pointer.

Transparent Border	Set whether to use the border of the slider control.
Border Color	Set the border color
Plate Color	Set the background color

- **Track Bar:** Set options for the track bar.

Display	Set whether to display the track bar of the slider control.
----------------	---

Width	Set the track bar width.
Color	Set the color of track bar.
Border	Set the border color.

– **Text:** Set options for text.

Display	Set whether to display text.
Size	Set the font size.
X Interval	Set the X-axis distance from the scroll pointer
Y Interval	Set the Y-axis distance from the scroll pointer
Color	Set the text color.

- **Display Trigger:** This is the display trigger setting for the slider control object.

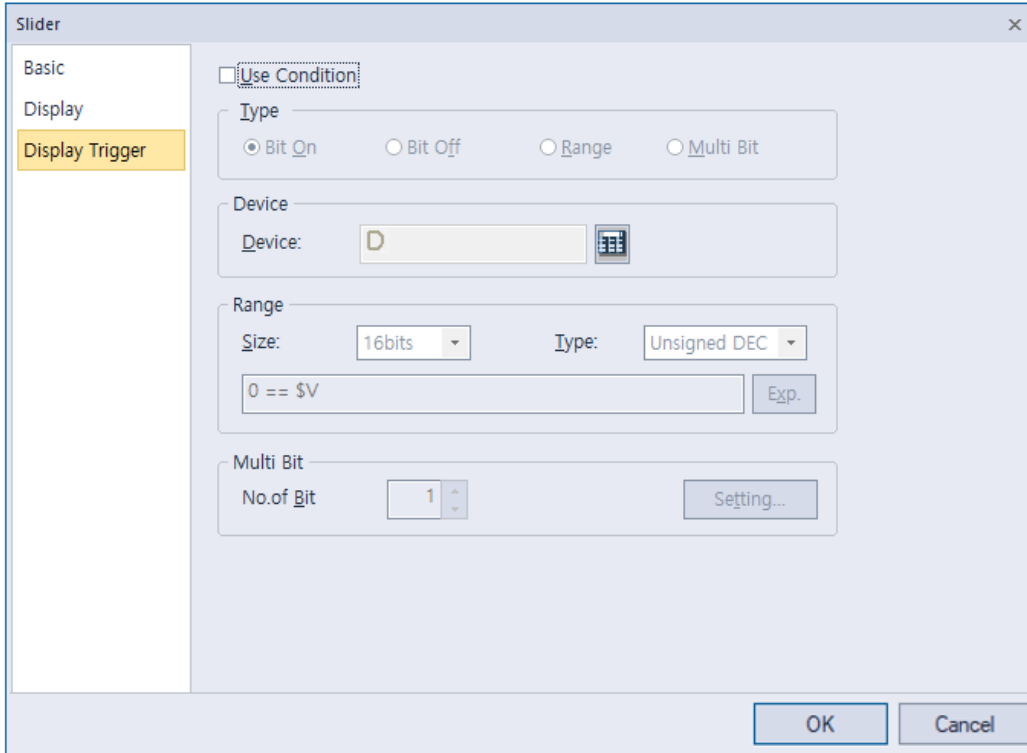

- **Use Condition:** Select whether to use the display trigger.
- **Type:** Set the type of the condition.

Bit On	Displayed when the device is on
Bit Off	Displayed when the device is off
Range	Displayed when the value is included in the set area
Multi Bit	It operates when the result of multiple devices satisfies the logical command.

- **Device:** Enter the device or tag address directly in the input area or use the keypad buttons. Network settings are also possible when you press the keypad button to open the device window.
- **Range:** If you select the range condition, specify the range.

Size	16 bit or 32 bit.
Type	Signed decimal, unsigned decimal, BCD, or Float
Exp.	Click to designate the expression as conditional.

- **Multi Bit:** If you select the multi bit condition, specify the number of bits and click [Setting] to specify the bit conditions.

4.4 Viewing or Changing XGT Panel Information

To view or change XGT Panel information:

- 1 In XP-Builder, click [COMMUNICATION] ► [XGT Panel Information].
- 2 Click a tab to view or change the following information:
 - **General:** The General tab allows you to view properties for the XGT Panel.

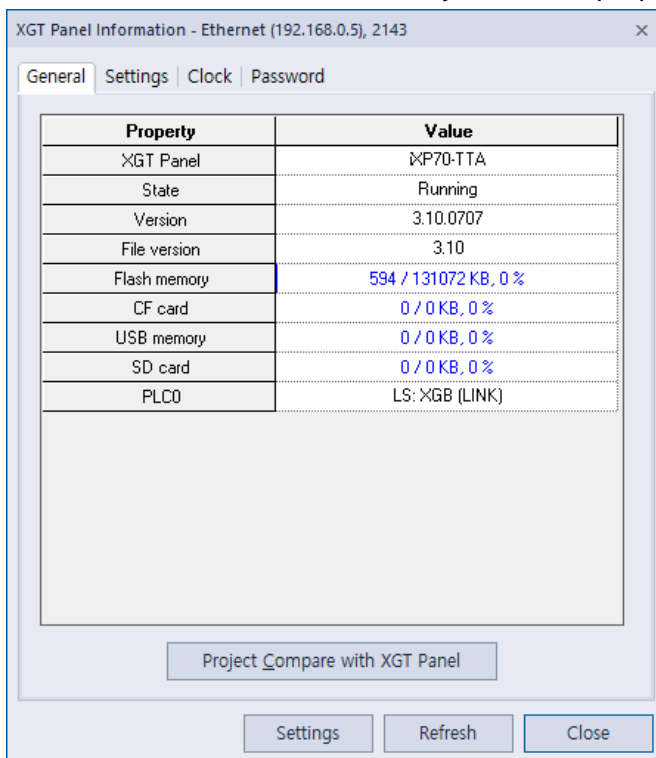

- **XGT Panel:** The XGT Panel model number.
- **State:** The operational state of the XGT Panel.
- **Version:** The XGT Panel version.
- **File version:** The file version.
- **Flash memory:** Used and available flash memory.
- **CF Card:** Used and available memory on an installed CF card.
- **USB Memory:** Used and available memory on an installed USB device.
- **SD Card:** Used and available memory on an installed SD card (For iXP/IPC series only).
- **Project Compare with XGT Panel:** Check if the modified download is enabled. The check compares the project's ID in the HMI with the current project ID. If the project IDs differ, a full download is required. Even if the two projects are the same, they may be considered as different projects. Errors occur if a project is deleted from the HMI because of communication errors or if the project ID is changed when the project is sent to another HMI device for completion of the project. The following screenshots show messages for projects that are the same and different.

- **Settings:** The Settings tab allows you to specify the following settings:

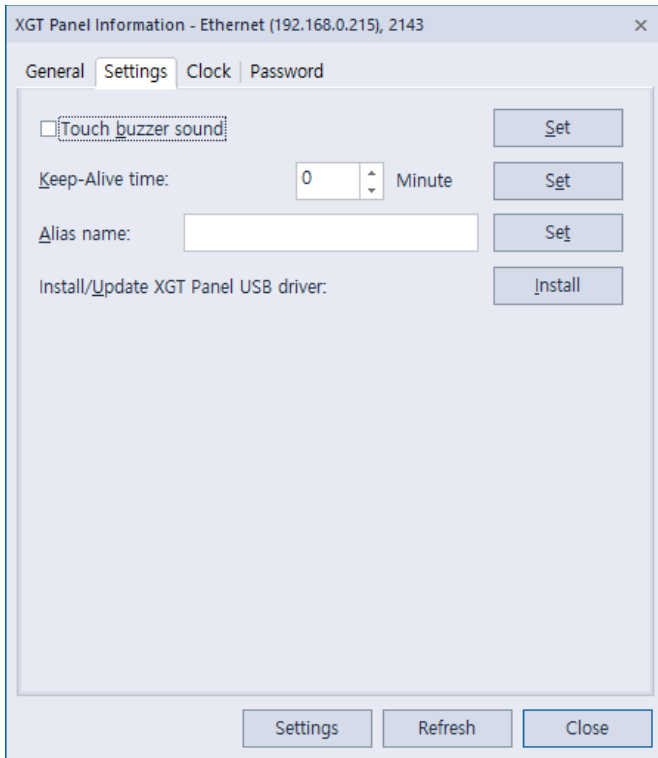

- **Touch Buzzer Sound:** Set whether or not to use audible feedback when a user touches the XGT Panel screen. This feature is not supported by the IPC series.
- **Keep-Alive Time:** Set how long the server will keep the communication port open if there is no response from the XGT Panel.
- **Alias Name:** Specify an alias to use when scanning for or connecting to the XGT Panel.

- **Clock:** The Clock tab allows you to specify the following settings:

The screenshot shows the 'Clock' tab of the 'XGT Panel Information' window. It features two date/time pickers: 'Date' set to '4/16/2013' and 'Time' set to '3:13:17 PM'. Each picker has a 'Set' button to its right. Below these is a 'Synchronise with PC time' button. The window title is 'XGT Panel Information - Ethernet (192.168.0.1), 2143'. At the bottom, there are 'Settings', 'Refresh', and 'Close' buttons.

- **Date:** Specify the date. Click [Set] to apply your settings to the XGT Panel.
 - **Time:** Specify the time. Click [Set] to apply your settings to the XGT Panel.
 - **Synchronize with PC Time:** Click to apply the computer's time to the XGT Panel.
- **Password:** The Password tab allows you to specify or delete the password that is required when transferring a project to the XGT Panel.

The screenshot shows the 'Password' tab of the 'XGT Panel Information' window. It contains three password input fields: 'Previous password' with a 'Delete' button, 'New password' with a 'Set' button, and 'Confirm password' with a 'Set' button. A note below the confirm field states '(Maximum 10 characters)'. The window title is 'XGT Panel Information - Ethernet (192.168.0.1), 2143'. At the bottom, there are 'Settings', 'Refresh', and 'Close' buttons.

- **Previous Password:** Enter the current password and click [Delete] to delete it.
- **New Password:** Enter a new password and click [Set].
- **Confirm Password:** Re-enter the new password and click [Set].

4.5 Using the HTML Device Copier

You can use the HTML Device Copier to copy and paste the device values onto a web page to monitor the devices on the web.

To copy and paste the devices:

- 1 Create a project.
- 2 Click [TOOL] ► [HTML Device Copier].

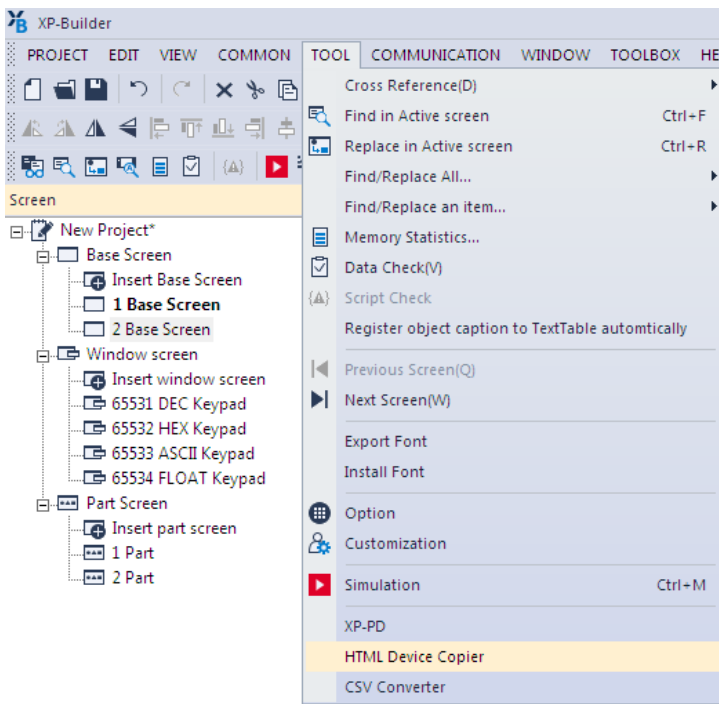

- 3 Specify the action type and size, and enter the device address.

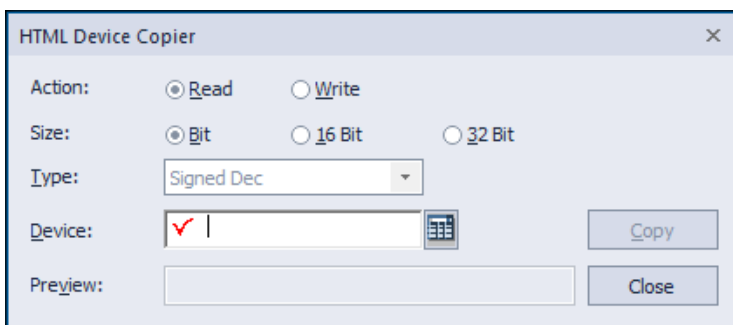

- 4 Click [Copy] to copy the device value.
- 5 Paste it on an HTML editor to use it on a web page.

Note

HTML functions related to the device monitoring

-
- GetXPData [Parameter 1] [Parameter 2] [Parameter 3]
[Parameter 1] device value read in text string
[Parameter 2] 4 byte device address in hexadecimal numbers
[Parameter 3] return data type (1–7)*
 - SetXPData [Parameter 1] [Parameter 2] [Parameter 3]
[Parameter 1] device value to be written
[Parameter 2] 4 byte device address in hexadecimal numbers
[Parameter 3] return data type (1–7)*
- * Return data types are: 1. Signed decimal, 2. Unsigned decimal, 3. Octonary,
4. Hexadecimal, 5. Binary, 6. BCD, 7. Real number
-

4.6 Using the CSV Converter

You can use the CSV converter to convert an encrypted CSV (CSVE) file into regular CSV file.

To convert a CSVE file to CSV format:

- 1 Click [TOOL] ► [CSV Converter].

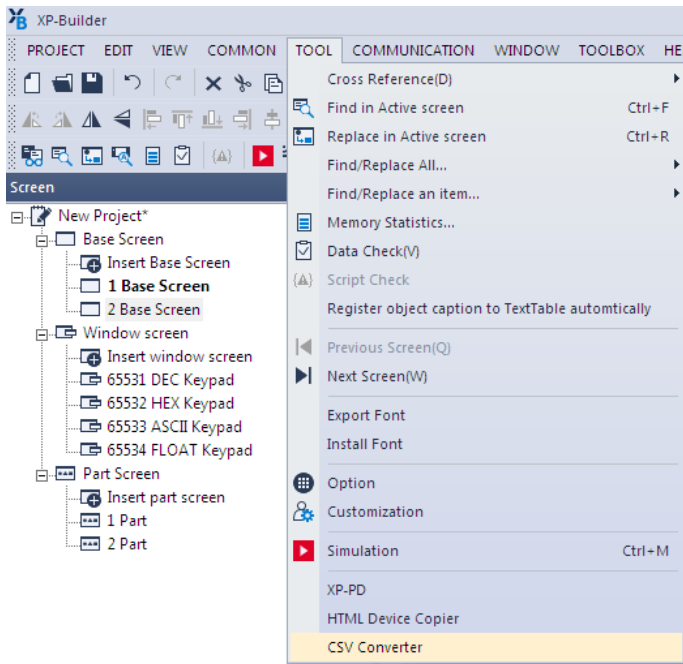

- 2 Click [Add CSVE Files], and then select the CSVE files in the file browser window.

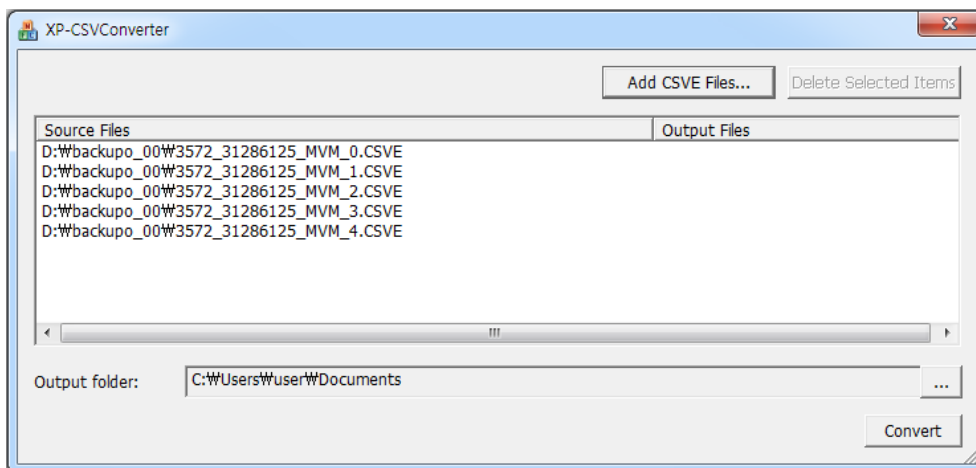

- 3 Click [...] on the right side of the Output folder field, and select the destination folder for the converted CSV files.
- 4 Click [Convert] to start conversion.

4.7 Managing External Storage Sources for Backup

This section describes how to control external storage sources when making file backups, such as logging, recipe, and screen image data. You can manage the backup data in this way:

- You can back up data, such as logging, recipe, and screen image data by saving them to a CF card, SD card, or a USB storage source, according to the settings contained in XP-Builder.
- If there is insufficient memory in the external storage source, the data will be deleted and the backup process will stop. Settings that control this situation are adjusted in XP-Builder.
- You can monitor if the external backup storage source has been recognized or not.
- When you are backing up data make sure that external storage sources are only removed when the safe removal switch is turned on and after the LED lamp turns off. Failure to observe these precautions may result in backup failure.

4.7.1 Managing the File Path for Backup Files

The file path shown below describes how backup files are routed:

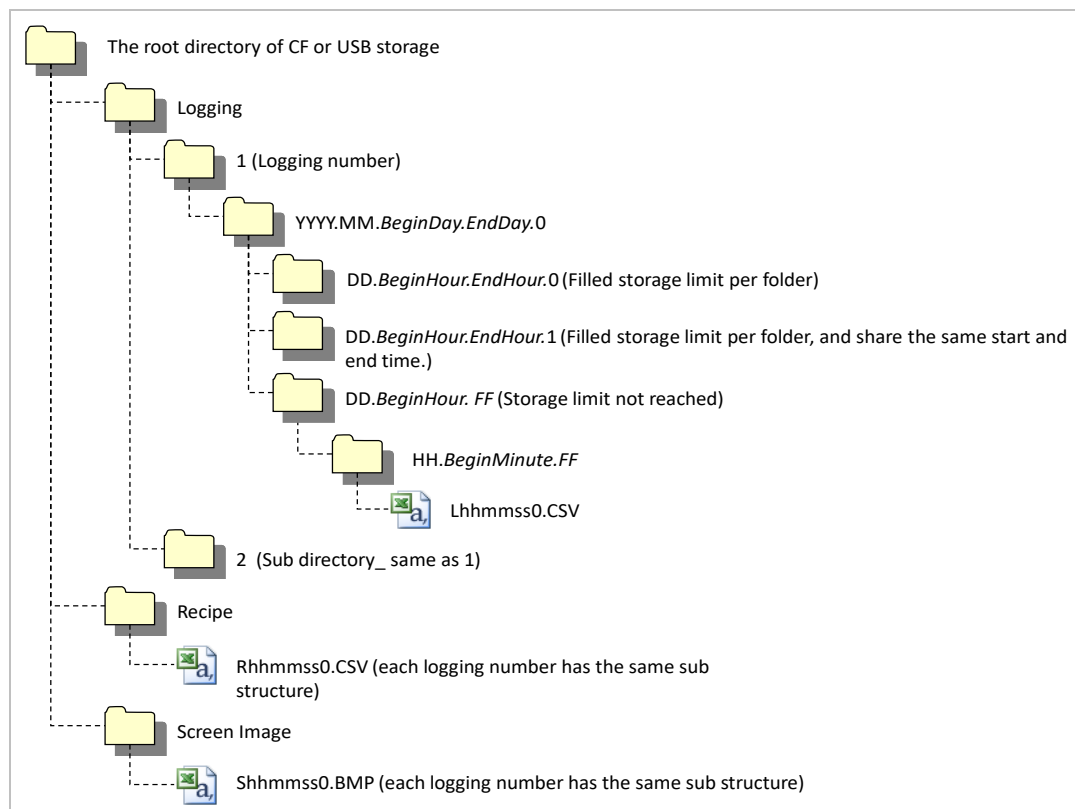

4.7.1.1 File Path for Logging Backup

- The 'Logging' subdirectory will be created under the root directory of the USB/CF/SD storage source.
- Under the 'Logging' directory, a subdirectory will be created with a filename generated by the logging number.
- Under the logging number directory, a subdirectory will be created with a filename by Year/Month.
 - The date directory will be included as a subdirectory.
 - Up to 500 date directories can be created.
 - The 'Year/Month' directory will not only contain year and month information, but will also record the date the directory was created.
As an example, the name of a directory created in October 2010 with subdirectories created since 15 October would be: *2010.10.15.FF*. The FF at the end of the directory name represents that there is more data space to store for October, 2010. (This means that the subdirectory currently holds less than 500 date directories).
 - When there is a change of Month, the directory name will be changed and saved to the last date in the month when information was logged.
As an example, if the directory contains date directories created between October 15 and October 30, and was created in October 2010, the directory name would be *2010.10.15.30.0* when the month changes to November 2010.
 - If a month directory is carrying more than 500 date subdirectories before the month ends, the directory name will change to the last date in the sub directory.
For example, if the number of date sub directories created from 1 October to 15 October 2010 is greater than 500 the file name will be: *2010.10.01.15.0*.
 - If the month ends or the total number of sub directories exceeds 500, or the directory has the same starting/ending date name, then the last index number is added to identify the directories.
As an example, if the directory created in October 2010 has 3 directories each holding 500 sub directories, then the directory names would be:
: *2010.10.01.01.0*
: *2010.10.01.01.1*
: *2010.10.01.01.2*
- Under the Year-/Month directory, a subdirectory with a date name will be created.
 - The date directory contains an hour subdirectory.
 - The date directory can hold up to 500 hour subdirectories.
 - The filenames of date directories contain date and hour information, for the first subdirectory that was created.
 - The rest of the directory creation procedure is identical to the Year/Month directory creation procedure.
- Under the Date directory, a directory will be created that will store time information created.
 - The Hour directory will contain backup files.
 - Each Hour directory can hold up to 500 backup files.
 - The Hour directory contains hour and minute information for the first file that was created.
 - The rest of the directory creation procedure is identical to the Year/Month directory creation procedure.
- Logging backup files have hour, minute, and second information as their file names.
 - Backup files will be created in CSV format.
 - The names of the files will begin with 'L', representing 'logging', and the rest of the name will contain hour, minute, and second index information.

- If the backup files are created simultaneously in the same second, additional index information will be added at the end of the file name.

4.7.1.2 Path for Recipe Backup

- A directory named 'Recipe' will be created under the USB/CF/SD storage root directory.
- A subdirectory will be created with filenames identified by Year/Month.
- The rest of the directory structure is the same as the logging backup file structure.
- Recipe backup files have hour, minute, and second information as their file name.
 - Backup files will be created in CSV format.
 - The filenames will begin with 'R', representing 'recipe', and the rest of the name will contain hour, minute, and second index information.
 - If backup files are created simultaneously in the same second, additional index information will be added at the end of file name.

4.7.1.3 Path for Screen Backup

- A directory named 'Screen Image' will be created in the USB/CF/SD storage directory.
- A subdirectory named by Year/Month will be created in the Screen Image directory.
- The rest of the directory structure is the same as the logging backup file structure.
- Screen Image backup files use hour, minute, and second information as their file names.
 - The backup files will be created in bitmap format.
 - The filenames will begin with 'S', representing 'Screen Image', and the rest of the name will contain hour, minute, and second index information.
 - If backup files are created simultaneously in the same second, additional index information will be added at the end of filename.

4.7.1.4 Path for Memo Backup

- A directory named 'Memo' will be created in the USB/CF/SD storage directory.
- A subdirectory named by Year/Month will be created in the Memo directory.
- The rest of the directory structure is the same as the logging backup file structure.
- Memo back up files use hour, minute, and second information as their file name.
 - The backup files will be created in bitmap format.
 - The filenames will begin with 'M', representing 'Memo', and the rest of the name will contain hour, minute, and second index information.
 - If backup files are created simultaneously in the same second, additional index information will be added at the end of the filename.

Note

- If time is set ahead of present time, normal operation is guaranteed. However, if time is set behind present time, normal operation is not guaranteed. If this situation arises, hour unit directories and all subdirectories should be deleted to resume normal operation. For example, if the date setting had been changed from 10th December to 5th December, Year/Month directories including 5th December will have to be deleted to enable normal operation to resume.
 - Logging, Recipe, Screen Image, and Memo functions do not support project classification. For instance, if Project A has logging groups numbered 1,2 and 3, and each logging group creates a file backup, 1,2,3 directory will be created and each file will be saved in a subdirectory. Then, if Project B has logging groups numbered 1 and 2, downloads the projects and creates file backups, these files can be mixed with Project A's backed up files. In this situation, the operator should classify Project A's and Project B's backup files by their download time.
-

4.7.2 Managing Memory for Backups

If there is insufficient memory in the external storage sources, data is deleted or backup processes stop depending on XP-Builder's configuration.

Using XP-Builder to delete the oldest data for backup, click [Common] ► [Project Property Setting] ► [Storage Settings], set the Backup Storage location for each file, and then click the checkbox next to **Delete old file if disk full**.

Data Type	Storage Location	Delete old file if disk full
Alarm data:	CF card	<input type="checkbox"/>
Logging data:	USB memory	<input checked="" type="checkbox"/>
Recipe data:	CF card	<input type="checkbox"/>
Capture image:	SD card	<input checked="" type="checkbox"/>
Memo file:	SD card	<input checked="" type="checkbox"/>
Operation Log:	SD card	<input checked="" type="checkbox"/>

When you back up the file by erasing the oldest files:

- If there is insufficient backup space, look for the earliest Year/Month subdirectories in Logging, Recipe, and Screen Image directories. When looking at Logging, look for subdirectories under the current back up logging number. For example, if Logging number 2 is on the current back up list but does not have data in the file's directory, data in logging number 1 directory will remain untouched.
- Look for the earliest date directory in the earliest Year/Month directory.
- Look for the earliest hour directory in the earliest date directory.
- Delete the earliest backed up files from the earliest hour directory.
- If more data space is needed, repeat the above steps and check available data space.
- When deleting files, if the whole hour directory has been cleared, remove the hour directory.
- When deleting hour directories, if a whole date directory has been cleared, remove the date directory.
- When deleting date directories, if a whole month directory has been cleared, remove the month directory.

Note

- If an unreadable directory or file (operator file or directory) is found, leave the directory or file and locate normal backup files.
- If the current directory contains only operator data, it will cause a backup failure. The XGT Panel cannot delete operator data, therefore it will stop any further action.

4.7.2.1 When there is Insufficient Memory or Exceeds the Limit

- Storage properties are configured in XP-Builder, project properties. By checking **Delete old file if disk full**, the earliest video files will be automatically located and deleted. If **Delete old file if disk full** is unchecked, then XP-Builder will stop and prompt the user with an error message.

4. Reference

- When the total number of files reaches 1000, delete the earliest created file from the earliest created directory. As files are deleted and the directory is emptied, the directory will then be deleted.

4.7.3 Monitoring External Storage Connection

XGT Panel monitors connections with external storage devices. Storage monitoring is set up in XP-Builder as shown below:

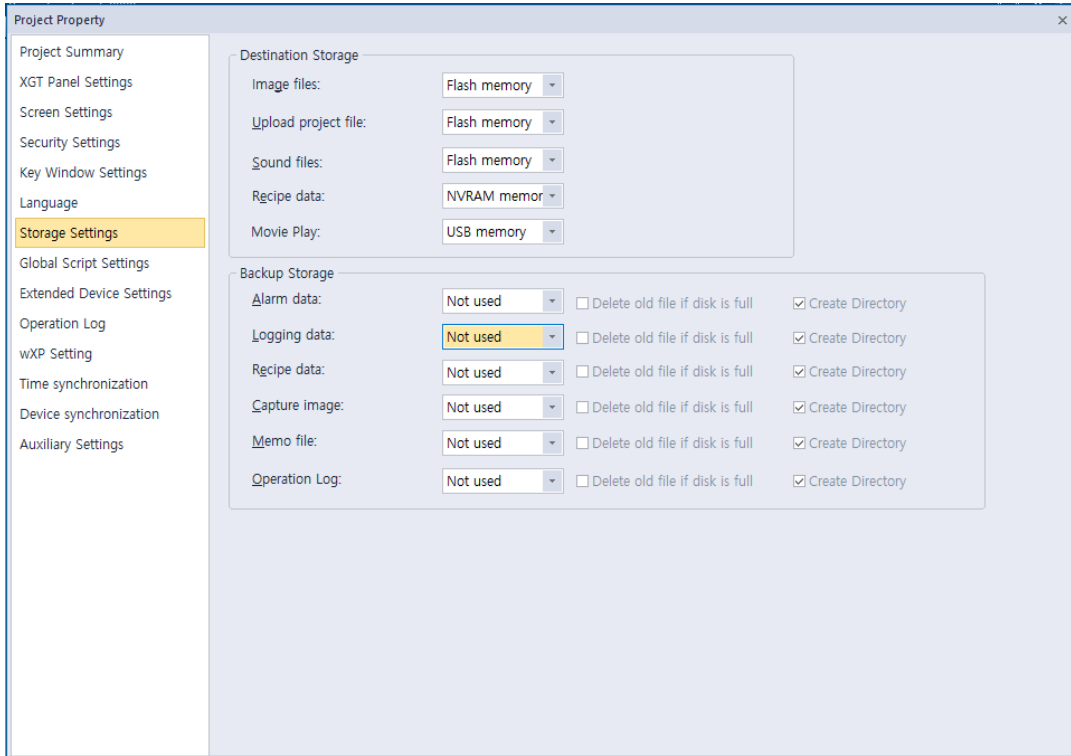

To use the monitoring function, you should select the **Alarm window pop-up** option, when you download the project file.

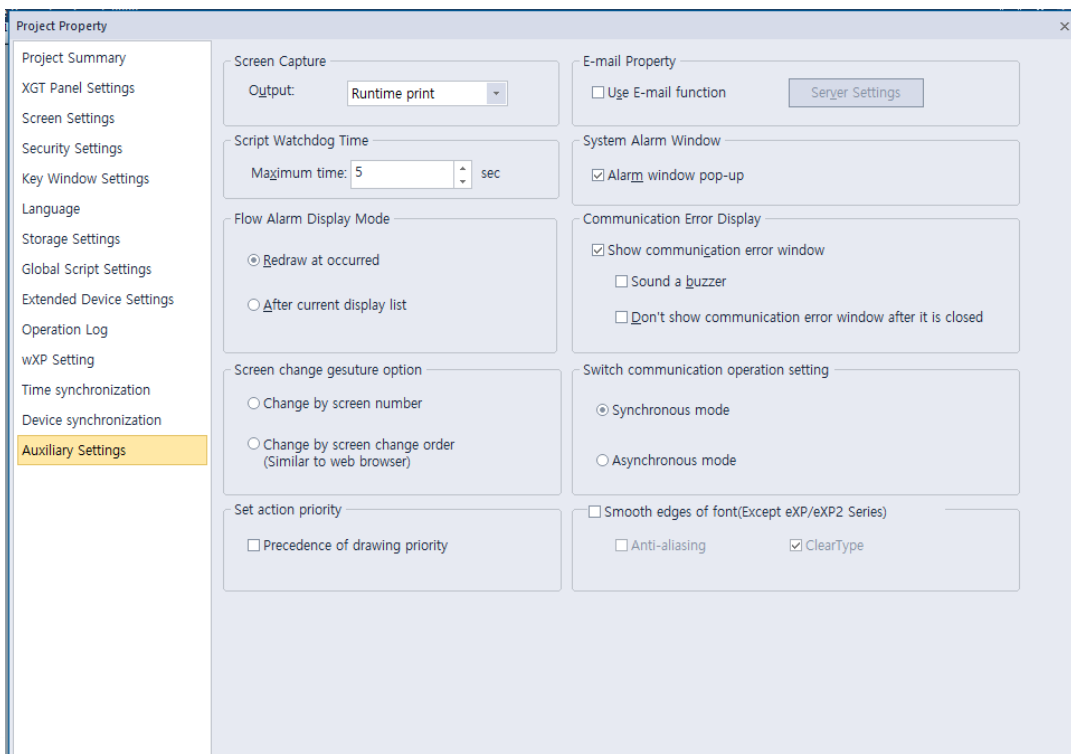

4. Reference

When the external storage device for logging, recipe, and screen image backup is removed from XGT Panel while the device is running, a system alarm is turned on. The alarm is reset when an external storage device is reconnected to the XGT Panel.

You can check system alarms and their device addresses in the System Alarm menu located in XP-Builder as shown below:

B-1		System Alarm	
	Device	Data Type	Description
1	HS950.0	BIT	NVRAM Low Battery Warning
2	HS950.1	BIT	NVRAM Invalid Data Warning
3	HS951.0	BIT	No Logging Backup Storage
4	HS951.1	BIT	No Recipe Backup Storage
5	HS951.2	BIT	No Screen Backup Storage
6	HS951.4	BIT	No Printer
7	HS950.8	BIT	USB Over Current Warning
8	HS951.3	BIT	No Alarm Backup Storage
9	HS951.5	BIT	No Memo Backup Storage
10	HS100.2	BIT	Failed to load XPLink parameter

4.7.4 Safe Removal Switch

The safe removal switch is used to remove external storage devices without any loss of backup data.

When the safe removal switch is on, and the storage device is not processing data, the LED lamp will turn off. If the storage device is processing data, the LED lamp will turn off after the backup is completed, automatically disengaging the storage device. This means that when the LED lamp is turned off no backup action will be completed and the data in the storage device is inaccessible.

When the safe removal switch is activated and the LED lamp is off, the storage device must be removed and reconnected to ensure that it is recognized. The minimum time delay for removing and reconnecting storage devices after their safe removal is 5 seconds.

The actions listed below describe situations where the LED lamp will not turn off even if the safe removal switch is turned on. The LED lamp will only go off after the described actions are fully completed:

- While a backup file is being created or XP-Builder is reading data
- If the images stored in the XP_User Image from an external storage device is being used as a part image and being loaded in the program
- While reading or writing a file recipe
- While reading backup data from the XP-server through an XP-Link connection
- While browsing backup lists to upload from XP-Builder
- While loading a sound file or an image that belongs to a project
- While transferring project backup data to a storage device or from XP-Builder
- While downloading a project using XP-Builder or a storage device
- While changing an image in the start menu
- While ladder program monitoring is being saved in a storage device

Function	Sub Classification	Action
Data Backup	Alarm	Writing
	Logging	Writing
	Recipe	Writing
	Screen	Writing
	Memo	Writing
	Video	Writing
	Still Shot	Writing
Data Upload	Alarm	Reading
	Logging	Reading
	Recipe	Reading
	Screen	Reading
	Memo	Reading

4. Reference

Function	Sub Classification	Action
	Video	Reading
	Still Shot	Reading
Data by Function	Part Image	Reading
	Edit File Recipe	Reading/Writing
	Send File Recipe	Reading/Writing
Web Server	Create Webpage	Writing
Sending XP-Link File		Reading
Inquire file list		Reading
Project Upload	Project Backup Communication	Reading
	Project Backup - Storage	Writing
Download Project	Image	Writing
	Sound	Writing
	Project Backup	Writing
Ladder Monitor	Download	Writing
	Execute	Reading
Change Start Menu Image		Reading
Download Storage	Project Data	Reading

5. Other features

5.1 Gestures & Multi-Touch

5.1.1 Gesture definition

1 Flick



You can quickly move up/down/left/right while maintaining contact with one finger.

2 Swipe



Slowly move up/down/left/right while maintaining contact with one finger

Note

- When using the gesture function without transitions, the touch position must be within the object to use the gesture function.

5.1.2 Screen Transition Gesture Function

- 1 The screen transition gesture function is performed only when there is no other object in the gesture motion range. It operates under the following conditions.

Gesture Direction	Gesture Type	Action Performed
Left	Flick	Switch to the next screen
Right	Flick	Switch to the previous screen

- 2 The screen transition gesture function works as soon as you release your hand after performing the flick operation.

Note

- The screen switching function is based on the screen number created by XP-Builder. As a result, the next screen changes to the next number screen on the current screen, and the previous screen changes the same way.

5.1.3 Logging Trend Graph Gesture Function

- 1** Logging Trend Graph The gesture function can recognize the gesture from the moment you touch the logging trend graph object. It operates under the following conditions.

Gesture Direction	Gesture Type	Action Performed
Left	Swipe	View next data 3 times
Left	Flick	View next data 1 time
Right	Swipe	View previous data 3 times
Right	Flick	View previous data 1 time

Note

- If you touch the Logging Trend Graph object, you can perform the gesture function and the blue frame will be displayed. This allows you to check whether the gesture is recognizable.

5.1.4 Logging View Gesture Function

- 1** Logging View Gesture function allows you to recognize the gesture from the moment you touch the Logging View object.

Gesture Direction	Gesture Type	Action Performed
Left	Swipe	View next column 1 time
Left	Flick	View next column 3 times
Right	Swipe	View previous column 1 time
Right	Flick	View previous column 3 times
Down	Swipe	View one line up 1 time
Down	Flick	View one line up 3 times
UP	Swipe	View one line down 1 time
UP	Flick	View one line down 3 times

Note

- History Alarm View when you touch an object, you can perform a gesture function and a blue frame is displayed. This allows you to check whether the gesture is recognizable.

5.1.5 History Alarm View Gesture Function

- 1 History Alarm View Gesture Function can recognize the gesture from the moment you touch the History Alarm View object. It operates under the following condition:

Gesture Direction	Gesture Type	Action Performed
Left	Swipe	View next column 1 time
Left	Flick	View next column 3 times
Right	Swipe	View previous column 1 time
Right	Flick	View previous column 3 times
Down	Swipe	View one line up 1 time
Down	Flick	View one line up 3 times
UP	Swipe	View one line down 1 time
UP	Flick	View one line down 3 times

Note

- When you touch the Logging View object, it becomes possible to perform the gesture function and a blue border is displayed. This allows you to check whether the gesture is recognizable.

5.1.6 Explorer/FTP Client gesture function

Alarm / File / Basic Recipe / File Recipe explorer gesture object recognition is possible from the moment you touch an object. It operates under the following conditions.

1 Alarm Explorer

Gesture Direction	Gesture Type	Action Performed
Down	Swipe	View one line up 1 time
Up	Swipe	View one line down 1 time

2 File Explorer

Gesture Direction	Gesture Type	Action Performed
Down	Swipe	View one line up 1 time
Up	Swipe	View one line down 1 time

3 Basic Recipe Explorer

Gesture Direction	Gesture Type	Action Performed
Down	Swipe	View one line up 1 time
Up	Swipe	View one line down 1 time

4 File Recipe Explorer

Gesture Direction	Gesture Type	Action Performed
Down	Swipe	View one line up 1 time
Up	Swipe	View one line down 1 time

5 FTP Client

Gesture Direction	Gesture Type	Action Performed
Down	Swipe	View one line up 1 time
Up	Swipe	View one line down 1 time

5.1.7 Multi-touch function

- 1 Up to 2 points can be simultaneously touched by the user at the same time.



- 2 Multi-touch function works on both normal screen and pop-up window (window screen, etc.).

Note

- The first touch input will automatically disappear when you perform an operation (Ex: numeral input device) that loses existing focus as the second touch input will open a new window when performing multi touch.
- Since the second touch coordinates are calculated based on the first touch input, if the first touch is released while the two points are touched at the same time, the second touch input value disappears. (On the other hand, if you remove your finger from the second touch and touch it again, it will work normally.)
- Multi-touch function is supported only in iXP2

5.1.8 Screen change gesture options

1 Screen change gesture method can be set as “Change by screen number,” “Change by screen-change order (Similar to web browser)”

Change by screen number

Perform the screen-changing gesture in the default set method to change to the previous or next screen based on the screen number.

Change by screen change order(Similar to web browser)

When performing the screen change gesture option, it changes to previous/next screen based on the order of the screen as moved by the user.

E.g If the user changed screen in order to 1->10->20 by screen-change switch, move to screen number 10 by performing previous screen change gestures on screen number 20.

2 Setting Method

Possible to set the “Screen change gesture method” option in [Project Property]-[Auxiliary Settings] of XP-Builder

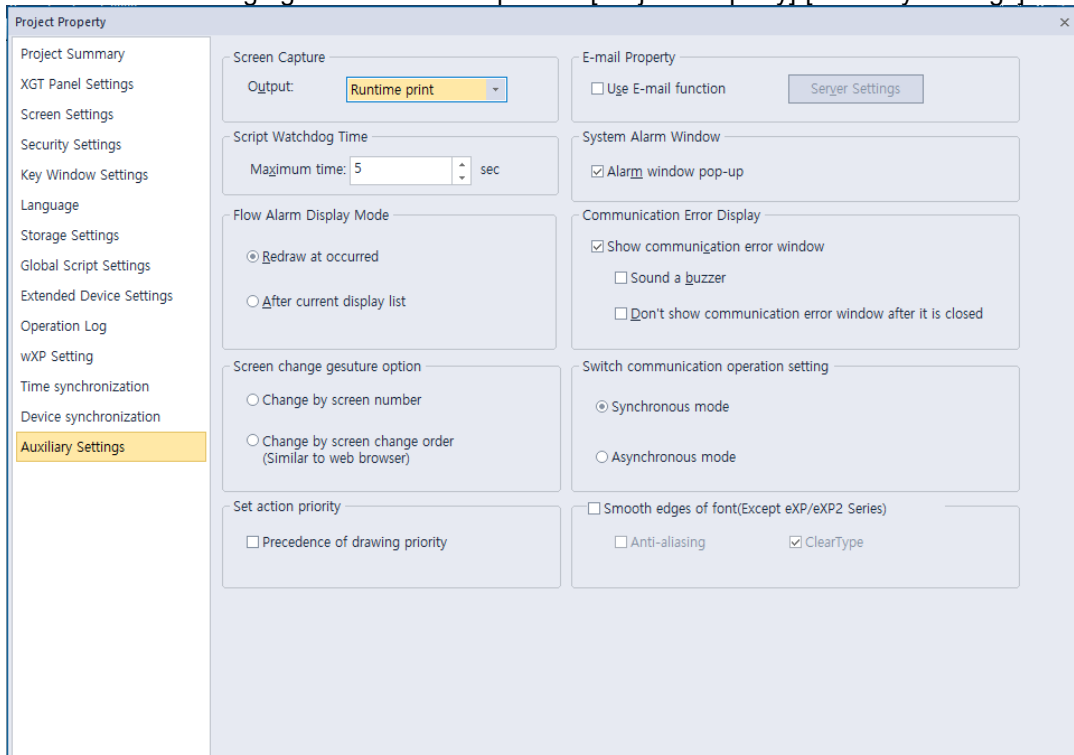

5.1.9 Gesture function On/Off

- 1 The user can select whether the gesture function is activated or not.
- 2 XP-Runtime menu - Settings - Touch Setting, you can check the "Gesture Function" check box as below.

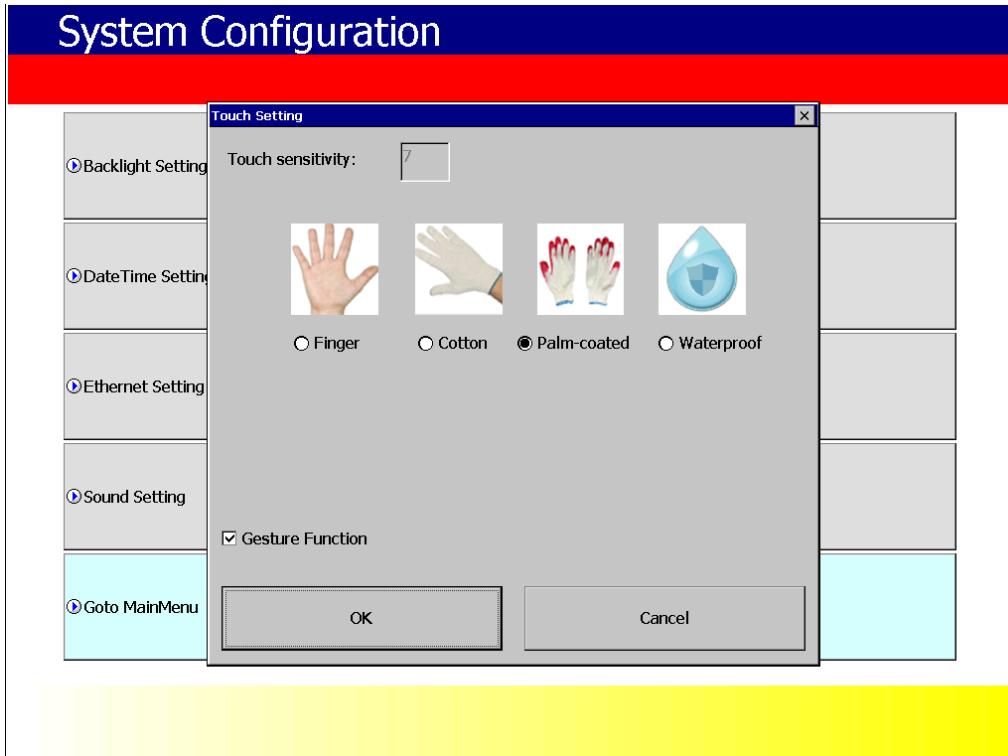

- 3 If you check the "Gesture Function" check box, the gesture function will be on. If you uncheck it, the gesture and multi touch will be off

Appendix

1 Program Monitor

The Program Monitor allows you to check the status of the system and diagnose PLC errors.

1.1 About Program Monitor

The Program Monitor works with PLCs that support the monitoring function, as described in **<5. 1.1.1 PLCs that Support Monitoring >**. The function shows the ladder diagrams for each PLC that can be monitored, as described in **<5. 1.1.3 The Program Monitor Window>**.

1.1.1 PLCs that Support Monitoring

You can only monitor PLCs that use the ladder diagram (LD) language. If a program uses the IL language, it will be converted to LD for display in the Program Monitor window. The following table describes PLC types manufactured by LS ELECTRIC that support monitoring.

Series	PLC Type	Maximum Program Capacity (Steps)
XGK	XGK-CPUA	32K
	XGK-CPUE	16K
	XGK-CPUH	64K
	XGK-CPUS	32K
	XGK-CPUU	128K
	XGK-CPUSN	64K
	XGK-CPUHN	128K
	XGK-CPUUN	256K
XGB	XGB-XBCE	4K
	XGB-DR16C3	10K
	XGB-XBCSU	15K
	XGB-XBCH	15K
	XGB-XBMS	10K
	XGB-XBMH	64K
	XGB-XBCU	32K

The following table describes connection types that support monitoring.

Series	Connection Type
XGK	CPU connection
	Link connection
	Ethernet connection
XGB	CPU connection
	Link connection
	Ethernet connection

Note

Link connection and Ethernet connection are only for modules that has the XGT server function. Refer to the module's user manual to learn more about each module.

The following table describes device types that support displaying monitoring data or changing current values.

Device	XGK		XGB	
	Monitoring Data Display	Current Value Change	Monitoring Data Display	Current Value Change
P	●	●	●	●
M	●	●	●	●
K	●	●	●	●
F	●	◐	●	◐
T	●	●	●	●
C	●	●	●	●
U	●	●	●	●
Z	●	●	●	●
S	●	●	●	●
L	●	●	●	●
N	●	●	●	X
D	●	●	●	●
R	●	●	△	△
ZR	●	●	△	△

(●: Supports all areas, ◐: Supports some areas, △: Supports some models, X: Not supported)

Note

Refer to the PLC's user manual to learn more about the device sizes and properties.

1.1.2 Properties by HMI devices

The following table shows the devices the support monitoring or the standard display lines.

HMI device	Resolution	Standard Display Line
XP30	320X240	7 lines
XP50	640X480	14 lines
XP70	640X480	14 lines
XP80	800X600	18 lines
XP90	1024X768	18 lines

1.1.3 The Program Monitor Window

The basic Program Monitor window appears below.



Item	Description	
a	The top row shows fundamental information about the program and the connected PLC.	
b	The monitoring area shows the LD program.	
c	LN	Set to scroll the screen by line or page.
		Scroll upward.
		Scroll to the left.
		Scroll to the right.
		Scroll downward.
		Move to the previous touch point.
		Move to the next touch point.
		Move to the next search result.
		Click to start or stop monitoring.
	Program/Variable Switch	
		Displays programs only.
		Displays devices/variables only.
		Displays the monitoring areas for programs and devices/variables in a split-view mode. Drag the line between the two areas to adjust the heights.

When you click the program/variable switch, you can monitor variables in the program as well.



Item	Description
d	Add, remove, or edit devices to monitor. Up to 16 devices can be monitored.
e	The monitoring area shows the devices.

1.2 Monitoring Program

You can monitor programs manually from the XGT Panel's menu or via a special switch object on a UI window. When you monitor programs via a special switch object, the objects on the screen will not communicate until the Program Monitor stops.

1.2.1 Monitoring Programs from the XGT Panel Menu

To start the Program Monitor from the XGT Panel menu:

- 1 Touch and hold the XGT Panel screen to open the main menu.
- 2 Touch [PLC Information].
- 3 Select a connection number from the drop-down list and touch [Program Monitor].

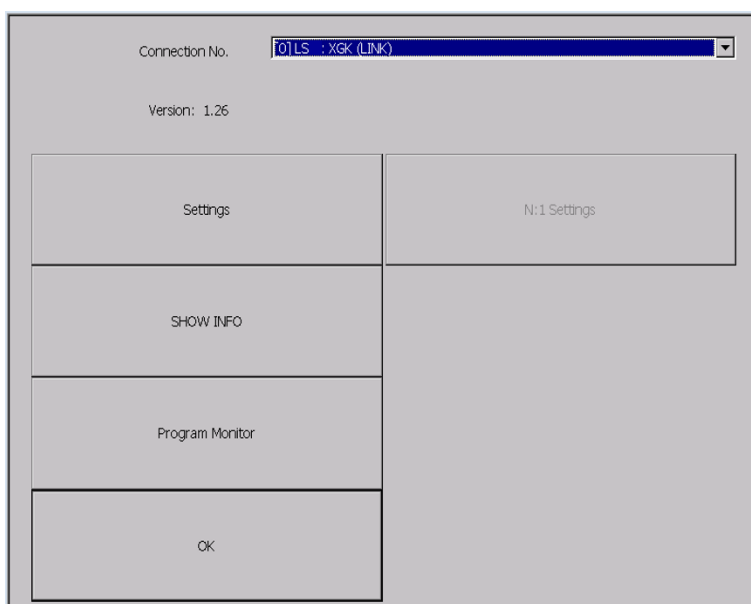

Note

If you have not selected the program monitor function in the XP-Builder project, the Program Monitor function will not be active. For more information, refer to [<2.2.2.2 Changing XGT Panel Settings>](#).

To stop the program monitor:

- 1 In XP-Builder, click [COMMON] ► [Project Property Setting] ► [XGT Panel Settings].
- 2 Touch the checkbox next to **Program monitor**.

1.2.2 Monitoring Programs with a Special Switch Object

To start the Program Monitor with a special switch object:

- 1 Create a special switch object in XP-Builder and transfer the project to the XGT Panel. For more information about special switch objects, refer to **<2.3.4 Inserting Figures or Objects>** and **<4.3.2.4 Special Switch>**.
- 2 On the XGT Panel, access the window that contains the special switch.
- 3 Touch the special switch to activate the Program Monitor.

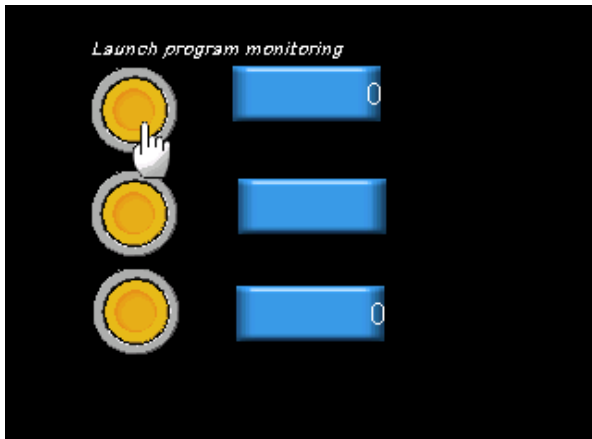

Note

While the Program Monitor is active, objects on the current screen cannot be monitored, but scripts and logging functions will work normally.

1.2.3 Selecting Programs to Monitor

Once you activate the Program Monitor, you must select which programs to monitor.

To select programs

- 1 In the Program Monitor window, touch a program from the program list and then touch [Select].

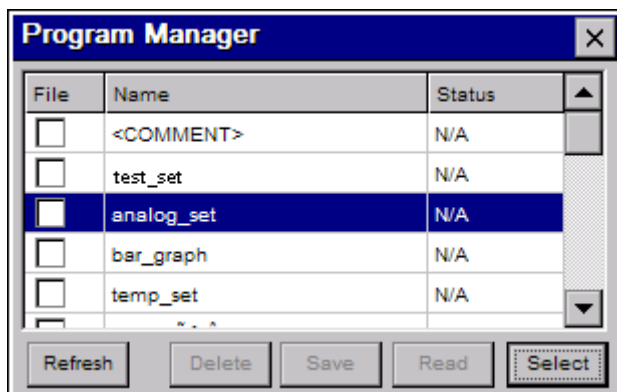

- 2 To begin monitoring the program, touch [Mon]. The LD program will appear in the monitoring area of the window.

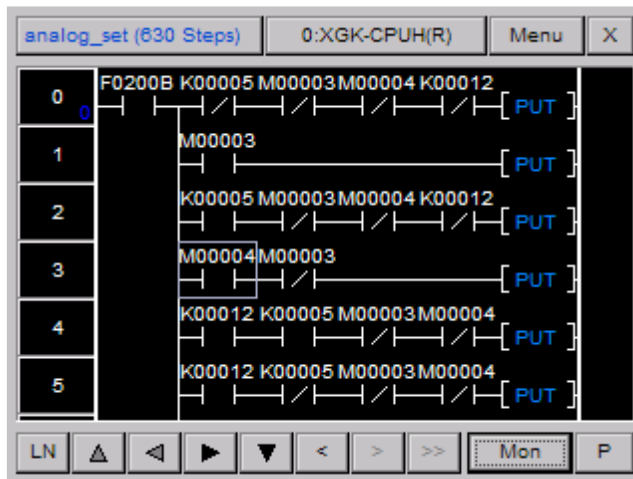

- 3 If the command is longer than the window can display, you can double-tap [PUT] to the right of the command to expand it. Tap [Close] to return to normal monitoring.

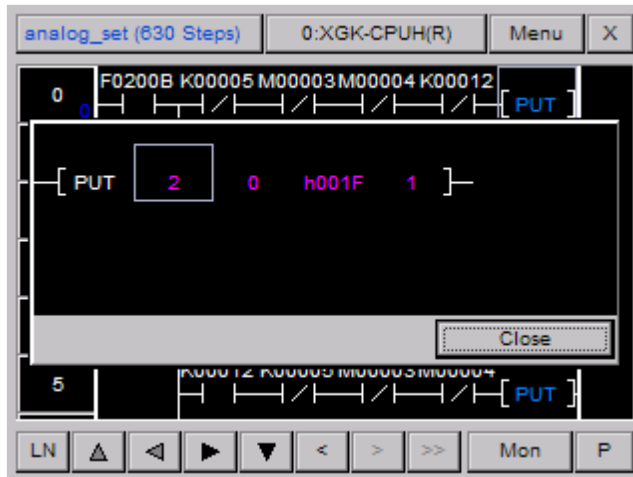

1.2.4 Managing Programs

You can save or delete programs from the Program Monitor.

To manage programs:

- 1 Touch the program list button at the top left of the window. To update the program list, touch [Update].

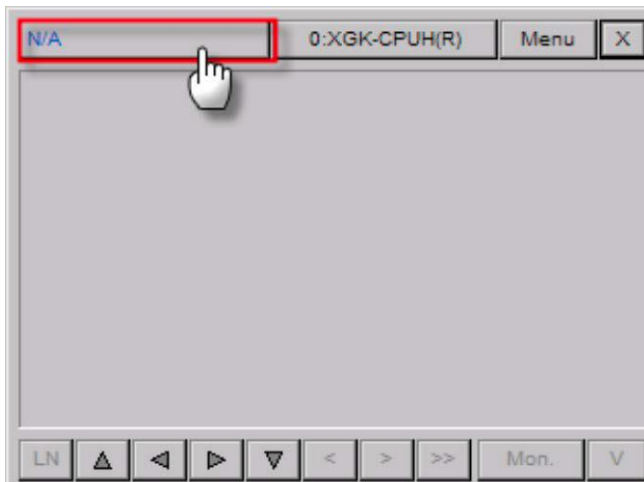

- 2 Touch a program to monitor ► [Select] to move to the monitoring window.

- 3 To read comments, touch [Comment] ► [Read].

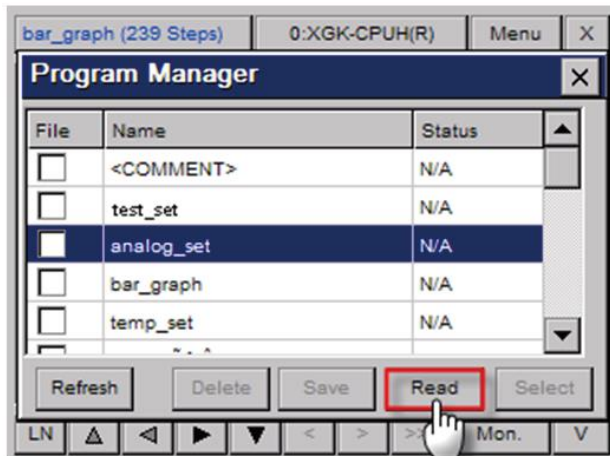

- 4 To save a program as a file, touch a program and then touch [Save]. When the program is saved "Match" appears in the Status column. If the file cannot be saved to the PLC, "Mismatch" appears in the Status column.

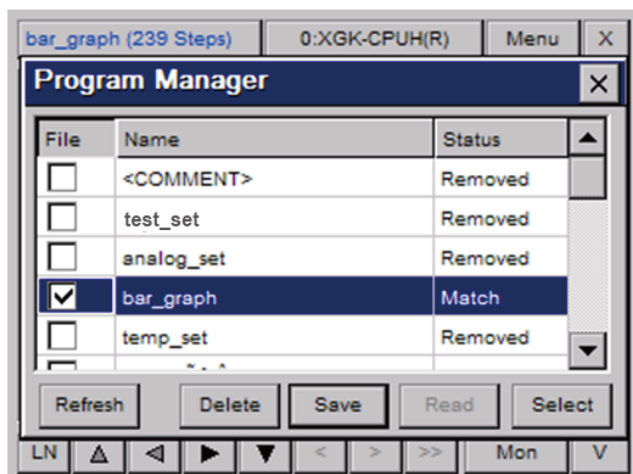

- 5 To delete a file, touch a program and then touch [Delete]. When the program is deleted, “Removed” appears in the Status column.

Note

The file saving or deleting functions are available only when the file saving option is checked.

1.2.5 Viewing the Monitoring Data

Monitoring data appear differently depending on contact, coil, and command.

Monitoring data of contacts are displayed as shown below.

Contact type	ON	OFF
Normally open contact		
Normally closed contact		
Positive transition-sensing contact		
Negative transition-sensing contact		

Monitoring data of coils are displayed as shown below.

Item	ON	OFF
Coil		
Negated coil		
Set coil		
Reset coil		
Positive transition-sensing coil		
Negative transition-sensing coil		

Monitoring value of each device is displayed on the top of a command. Monitoring values are displayed differently depending on the data type used in a command.

Command type	Monitoring data display
Compared command	
Command	

1.2.6 Changing the Display Format

In the Program Monitor, you can choose from four display formats for data, as described in the following table.

Format	Description
Unsigned decimal	Displays the current device value as an unsigned decimal number.
Signed decimal	Displays the current device value as a signed decimal number.
Hexadecimal number	Displays the current device value as a hexadecimal number.
Depending on command	Displays the current value based on the command properties.

To change the display format:

- 1 On the XGT Panel, touch and hold the screen to open the main menu.
- 2 Touch [Option] ► [Monitor].
- 3 In the Options window, touch a display format.

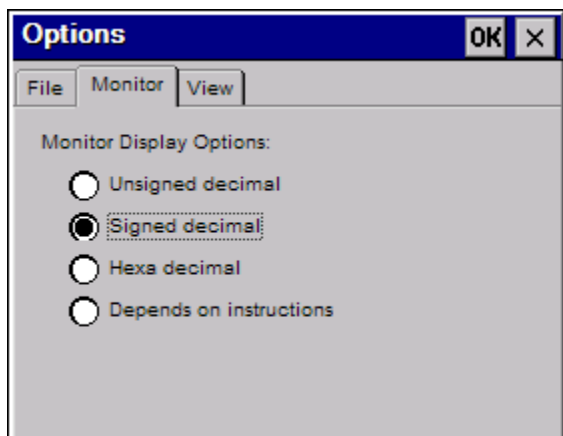

- 4 Touch [OK] to save your changes.

Note

Real number and string data types are displayed as real numbers and strings, respectively, of display format you choose. For more information about data types for each PLC command, refer to the PLC user manual.

1.2.7 Changing the Current Device Value

You can change the current device value from the Program Monitor. The Program Monitor must be running to change the device value.

To change the current value of a PLC device:

- 1 From the Program Monitor window, select a device.

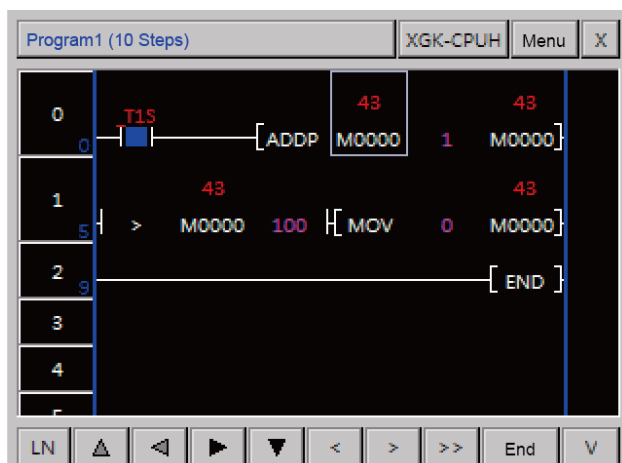

2 Tap [Menu] to display a menu dialog box.

3 Tap [Test] to change the value.



4 Enter a value in the **Value** field and tap [OK].

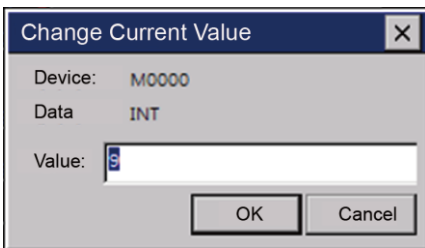

- You can also change current device value from the Device Monitor window.

5 From the Device Monitor window, tap the Value field of a device to change.

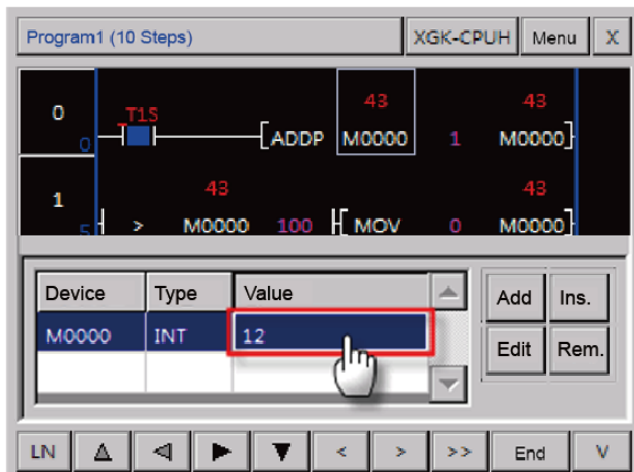

6 Enter a value in the **Value** field and tap [OK].

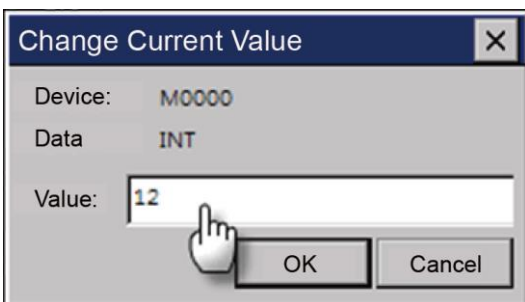

Note

When you select bit type device, the dialog box to select ON/OFF will be displayed. Number input unit or string input unit will be displayed depending on the inputted data type. After selecting the device to be changed, you can select the current device value.

1.3 Monitoring Devices

You can monitor devices that are not currently used by the program and check the status off the PLC.

1.3.1 Managing Devices

To add a device:

- 1 In the Device Monitor window, tap [Add].

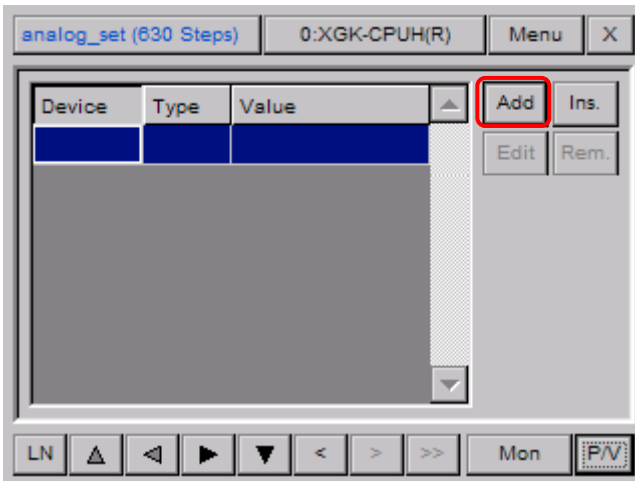

- 2 Tap the **Device** field to open the Add Device window.



- 3 Enter a device and tap [OK] in the Device Input window.



- 4 Tap the currently select device data type.

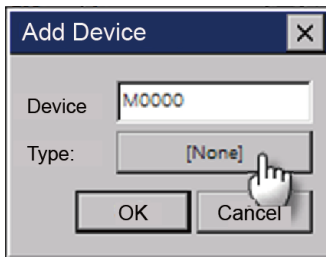

5 Select the desired device data type.

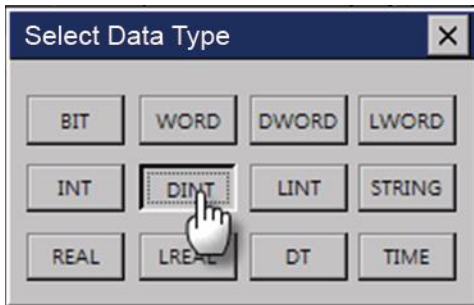

6 Tap [OK] to finish.



When you insert a device, the device will be added to the currently selected point. The procedure of inserting a device is the same as the procedure of inserting a device except that the point to insert a device is selected.

To insert a device:

1 In the Device Monitor window, select a point to insert a device and tap [Ins.].



2 Enter a device and select a device data type.



3 Tap [OK] to finish.

You can change the device or the device data type.

To edit a device:

1 In the Device Monitor window, tap [Edit].

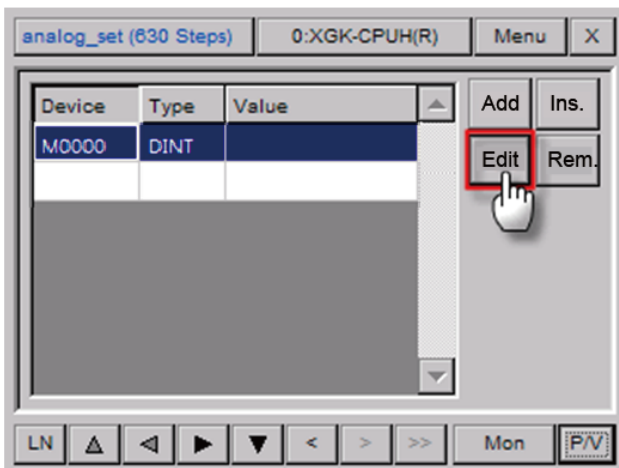

2 Change the device or the device data type, and tap [OK].



To remove a device:

1 Select a device to remove.



2 In the Device Monitor window, tap [Rem.].

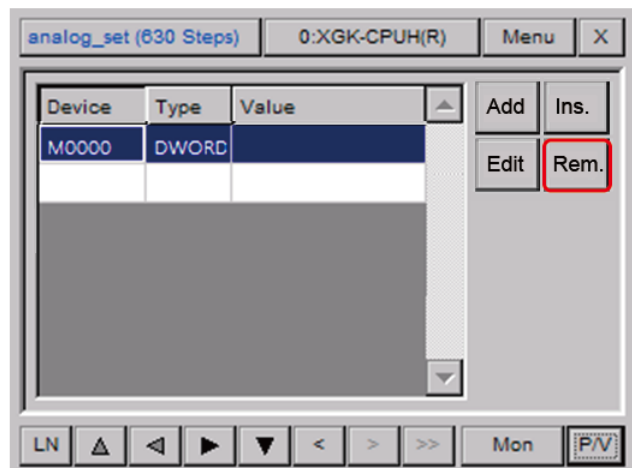

1.4 Using the Search Functions

You can use various search functions to find devices, labels, sub-routines, or cross references, or you can move to the desired step directly.

1.4.1 Searching for Devices

You can search for devices by setting the data type or the search range.

- 1 In the Program Monitor window, tap [Menu].

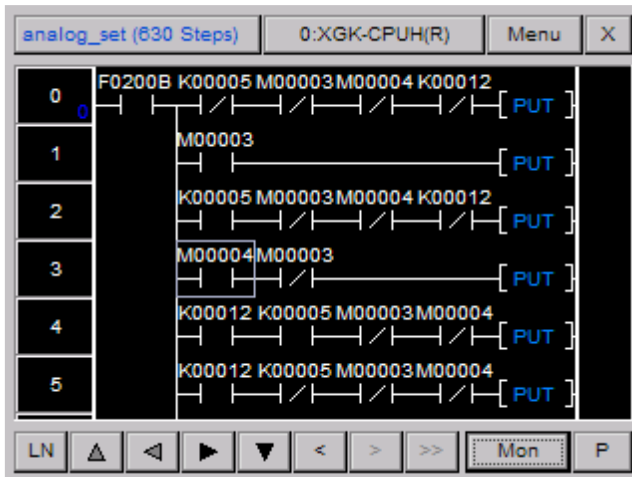

- 2 Tap [Search] to open the Device Search window.



- 3 Enter a device to search for.

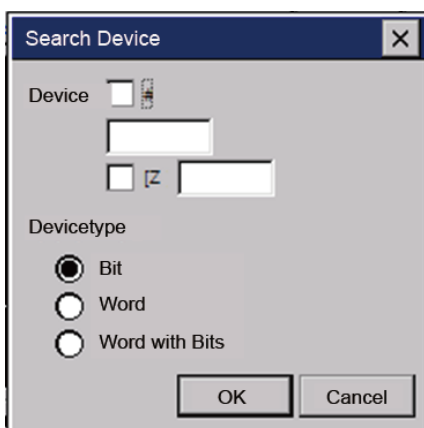

To enter a general device (for example, M0000):

- 1 Tap the device input field.

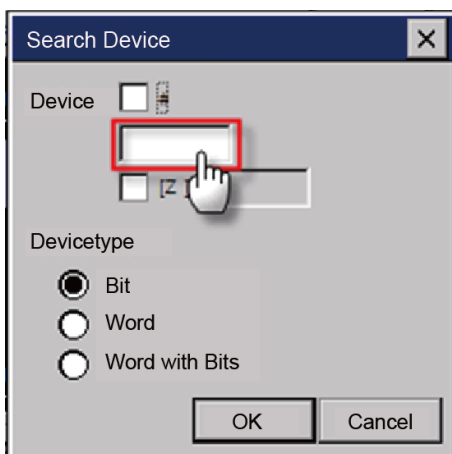

- 2 Enter the device address and tap [OK].

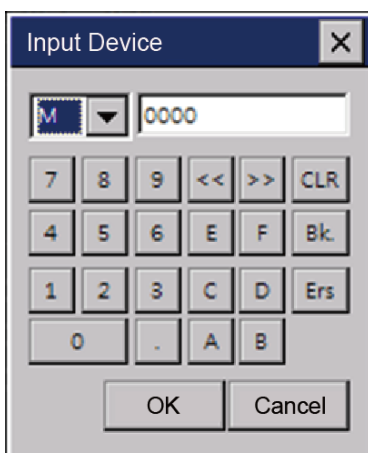

For an index device, two devices should be entered in the format of “Default Device [Index Device]”. The procedure for entering a default device is the same as the procedure for entering a general device.

To enter an index device (for example, M0000[Z000]):

- 1 Check the checkbox next to [Z].

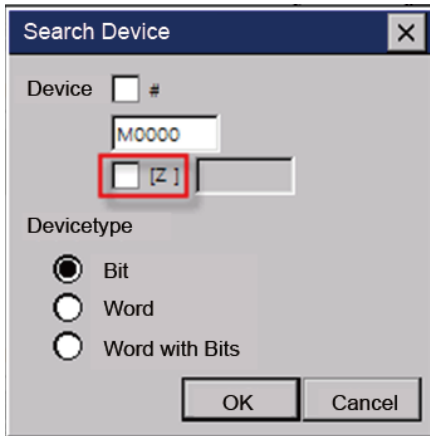

- 2 Tap the device input field.

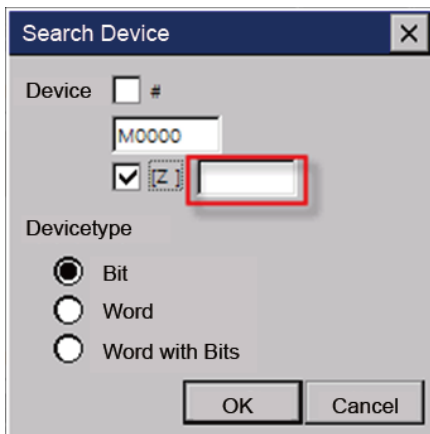

- 3 Enter the device address and tap [OK].

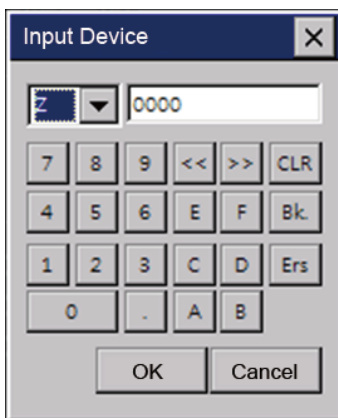

An indirect device is displayed in the format of “# + Default Device”.

The procedure for entering a default device is the same as the procedure for entering a general device.

To enter an indirect device (for example, #P0000):

- 1 Check the check box next to “#”.

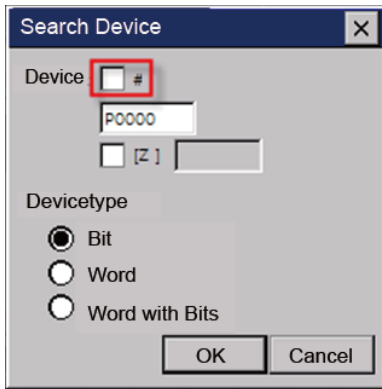

- 2 Tap the device input field.

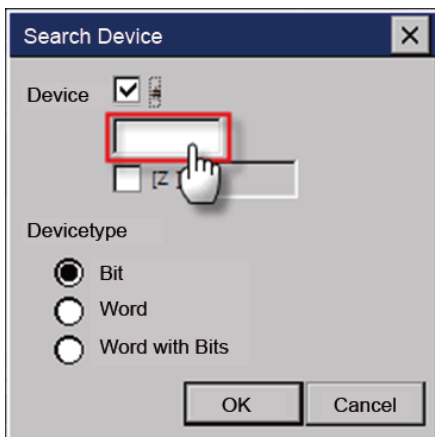

- 3 Enter the device address and tap [OK].

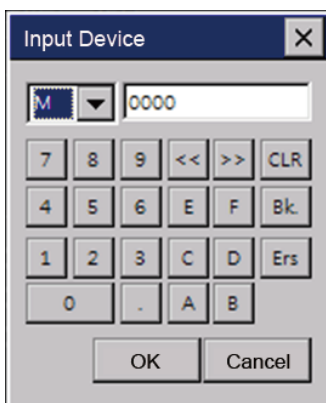

An indirect index device is displayed in the format of “# + Default Device [Index Device]”.

To enter an indirect index device (for example, #P0000[Z00]):

- 1 Check the checkbox next to “#”.



2 Check the checkbox next to [Z].

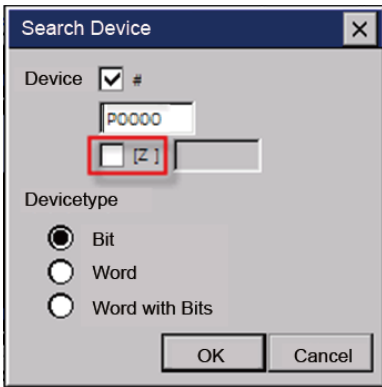

3 Tap the device input field.

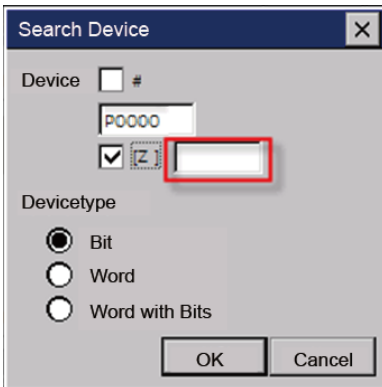

4 Enter the device address and tap [OK].

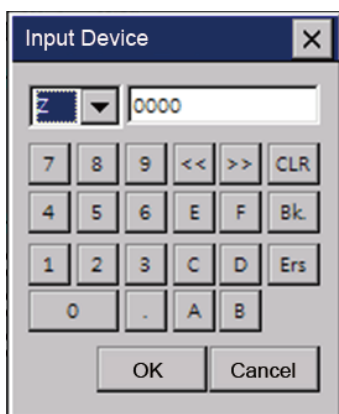

You can select a device type (Bit, Word, or Word with bit).

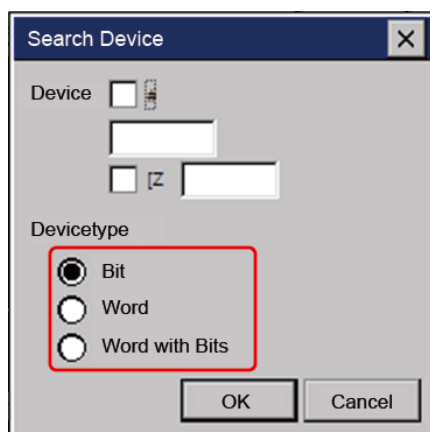



Device type	Description
Bit	Search for a match from bit devices.
Word	Search for a match from word devices.
Word with bits	Search for a match from word devices and a device containing a word device from bit devices. For example, if you enter "M0000" and select Word with bit type, the following devices will be searched. Word device: M0000 Bit devices: M00000, M00001, M00002- M0000F

Note

When you search for a device, devices of the same device type will be searched. For example, if you enter "M0000", devices such as M0000[Z000], #M0000, #M0000[Z000] will not be searched.

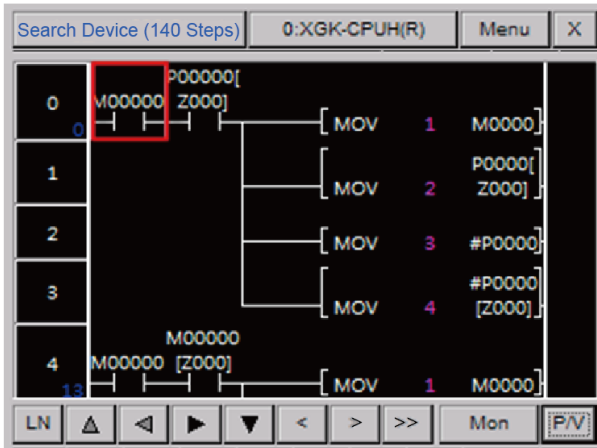
After entering the device, tap [OK] to search for devices. The pointer will appear at the first search result.



Tap  to move to the next search result.

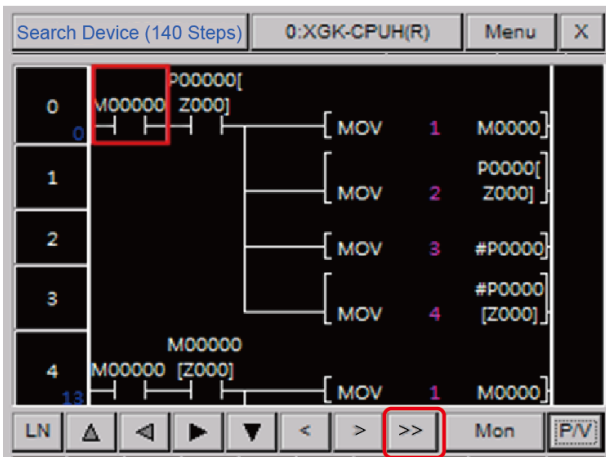

1.4.2 Searching for Labels

- 1 You can search for labels that are used in programs and move to the corresponding point directly.
- 2 In the Program Monitor window, tap [Menu].

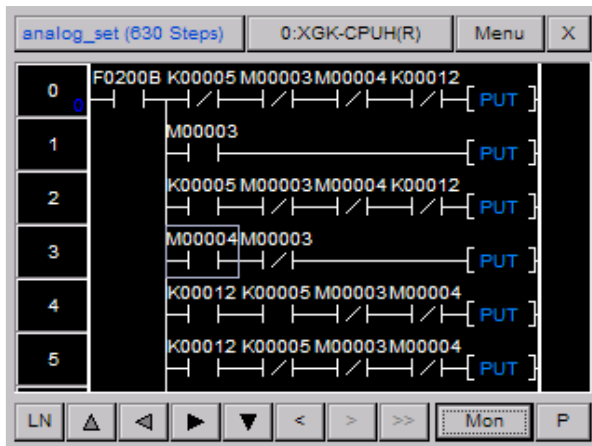

- 3 Tap [Search Label] to open the Label List window.

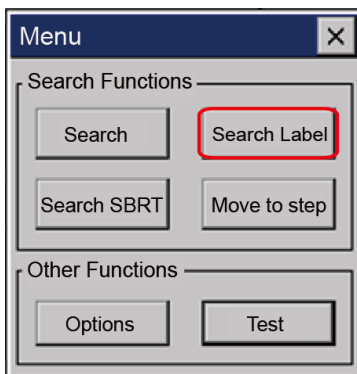

- 4 Tap the desired label and tap [OK].

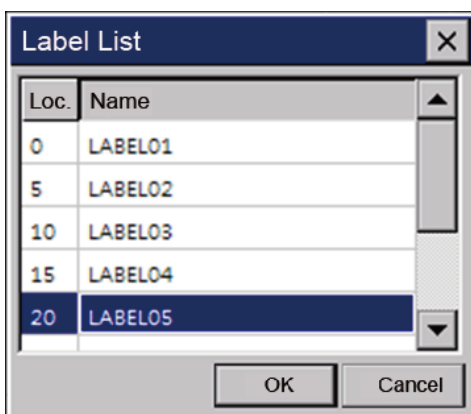

- 5 Confirm the search result.



1.4.3 Searching for Sub-routines

You can search for sub-routines that are used in programs and move to the corresponding point directly.

- 1 In the Program Monitor window, tap [Menu].



- 2 Tap [Search SBRT] to open the Sub-routine List window.



- 3 Tap the desired sub-routine and tap [OK].

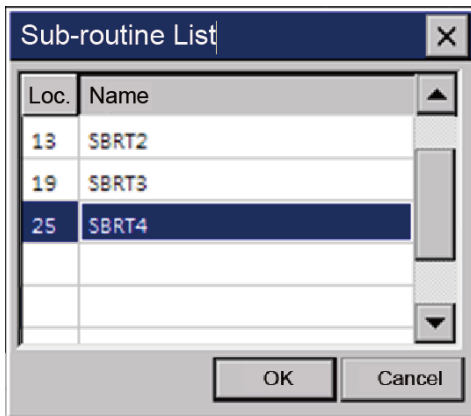

4 Confirm the search result.

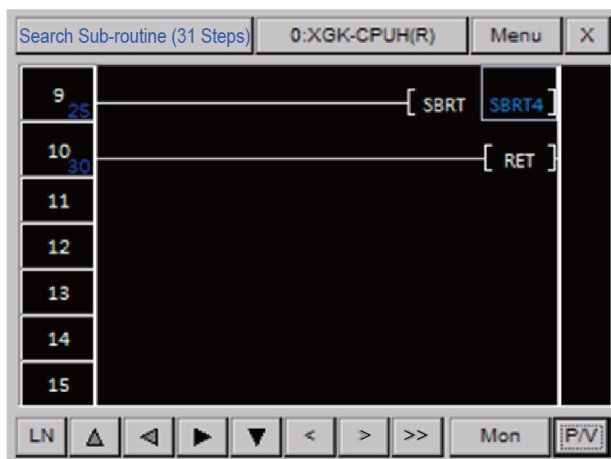

1.4.4 Searching for Steps

You can search for a step and move to the corresponding point directly.

1 In the Program Monitor window, tap [Menu].

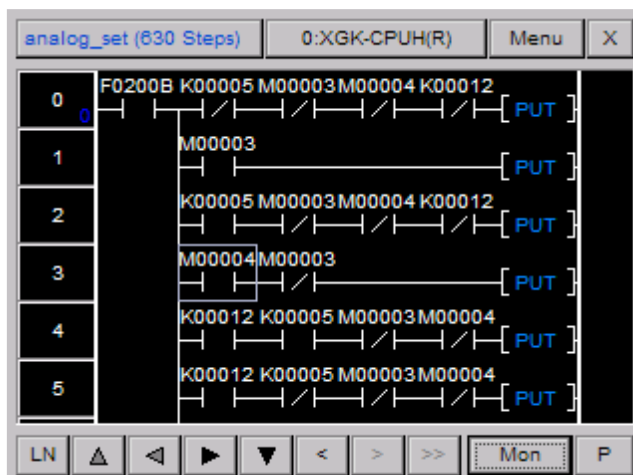

2 Tap [Move to Step] to open the Move to Step window.



3 Tap the step number field to open the Number Input window.

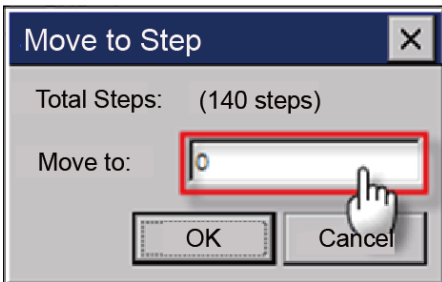

4 Enter the step number and tap [OK].

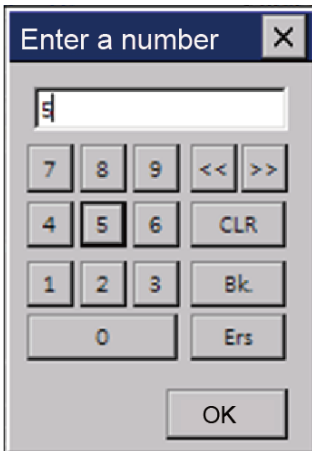

5 Confirm the search result.

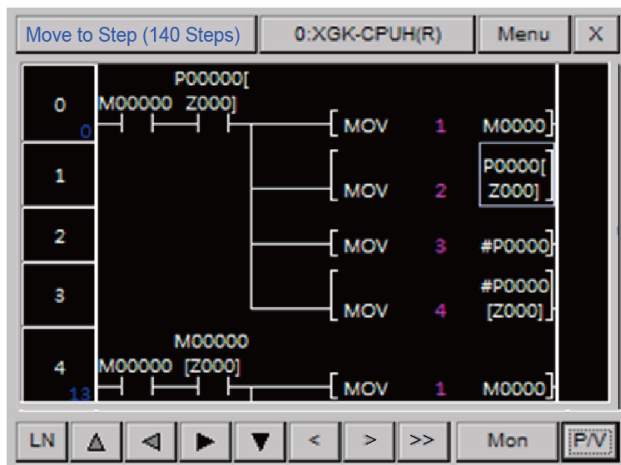

1.4.5 Searching with Touch

You can search for labels, sub-routines, or devices with touch.

1.4.6 Searching for Labels with Touch

You can search for a JMP command that a selected label refers to. You can also move directly to a label that a JMP command refers to.

Because more than one JMP command can exist for one label, you can move to the next search result.

To search for a JMP command that a label refers to:

- 1 Select a desired label.



- 2 Tap and hold the label command for a second.



3 Confirm the search result.



Because only one label exists for one program block, you cannot move to the next search result.

To search for a label that is used as an operand for a JMP command:

1 Select a desired JMP command



2 Tap the JMP command or the operand for a second.

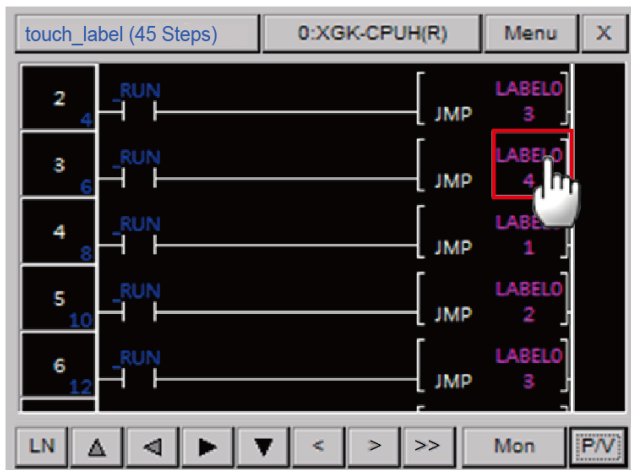

3 Confirm the search result.



1.4.7 Searching for Sub-routines with Touch

You can search for a CALL or CALLP command that a selected sub-routine refers to. You can also search for a sub-routine that is used as an operand for a CALL or CALLP command.

Because more than one CALL or CALLP command can exist for one sub-routine, you can move to the next search result.

To search for a CALL or CALLP command that a sub-routine refers to:

- 1 Select a desired sub-routine.

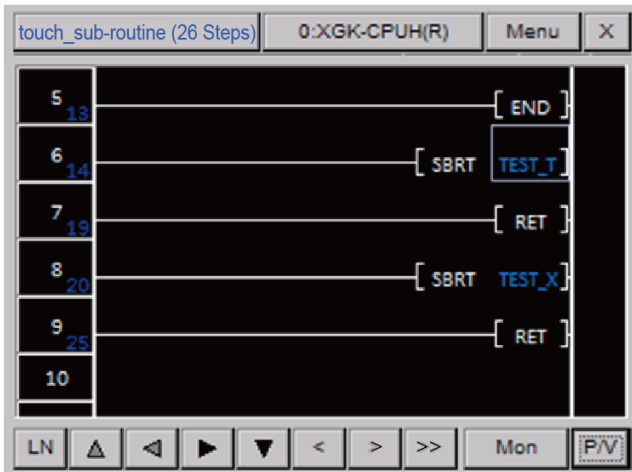

- 2 Tap and hold the sub-routine command or the operand for a second.

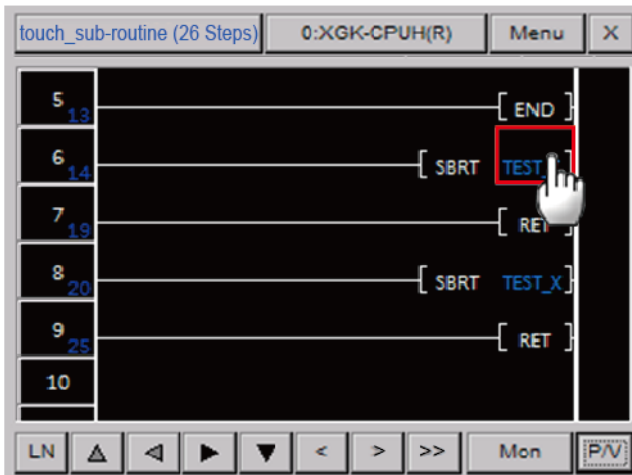

- 3 Confirm the search results.

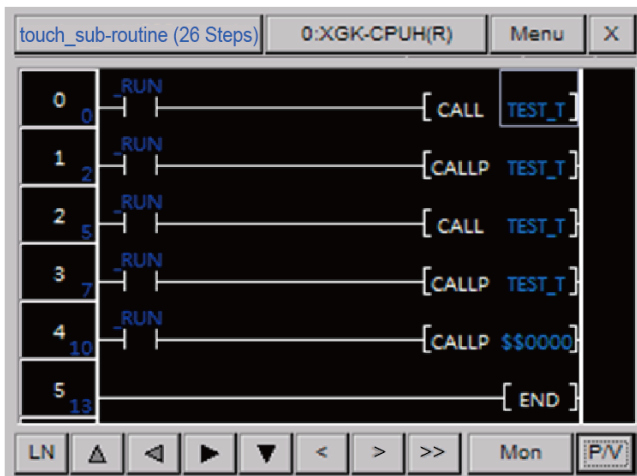

Because sub-routines exist in the entire PLC program, search results may not appear in the selected program.

To search for a sub-routine that a CALL or CALLP command refers to:

- 1 Select a desired CALL or CALLP command.

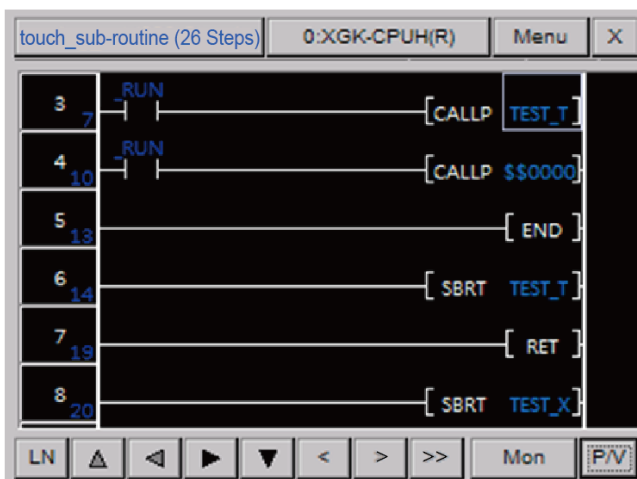

- 2 Tap the CALL or CALLP command or the operand for a second.

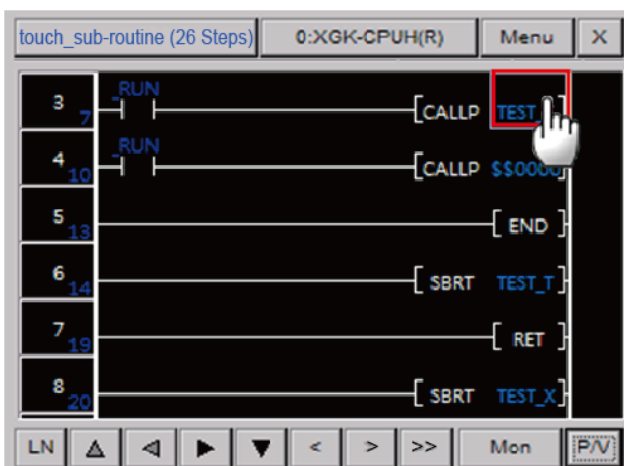

3 Confirm the search result.

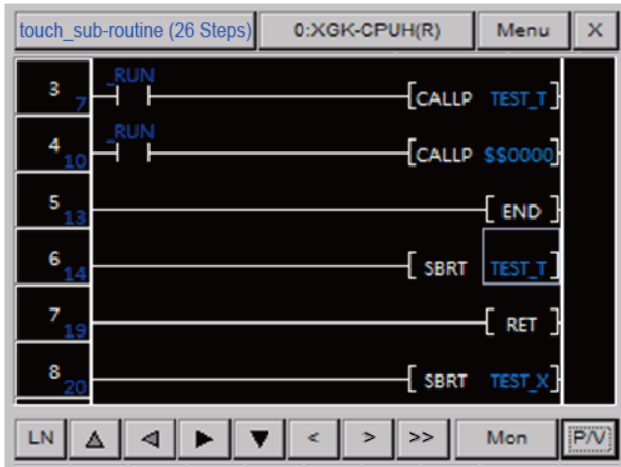

1.4.8 Searching for Devices with Touch

You can search for a device with touch to find out whether an input device is used for output or an output device is used for input.

To search for a command that uses a selected input device for output:

1 Select a desired input device.

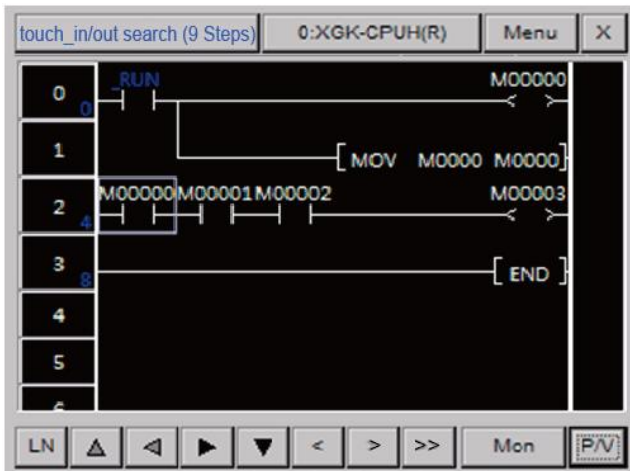

2 Tap the device for a second.

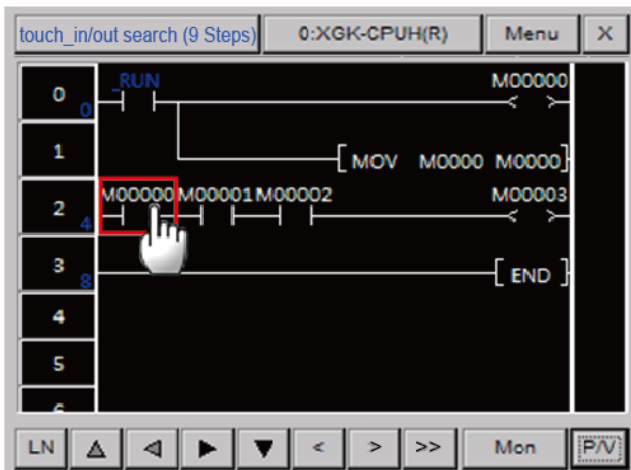

3 Confirm the nearest output device upward from the selected device.

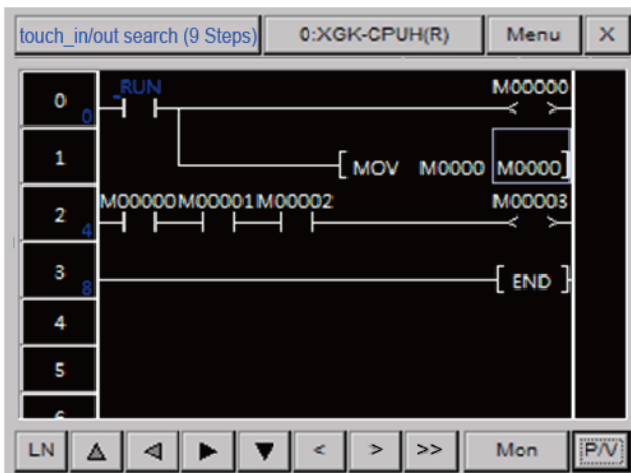

4 Tap **>>** to move to the next output device.

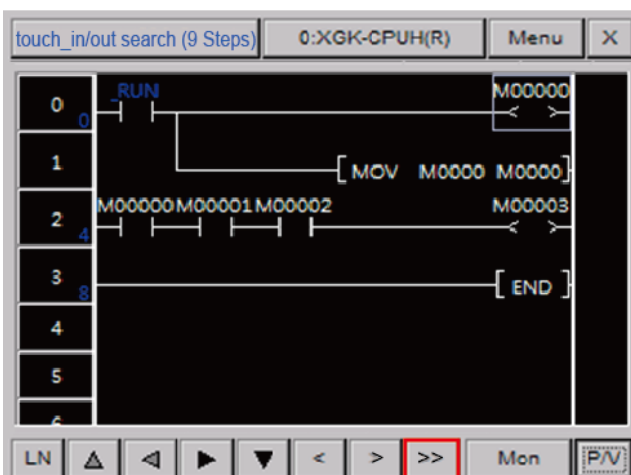

To search for a command that uses a selected output device for input:

1 Select a desired output device.

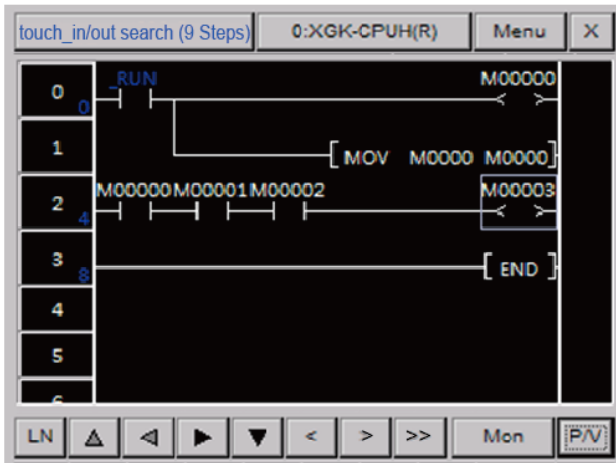

2 Tap the device for a second.

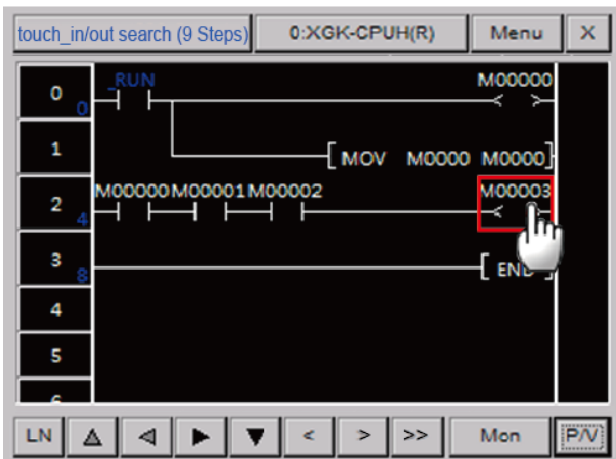

3 Confirm the nearest input device downward from the selected device.

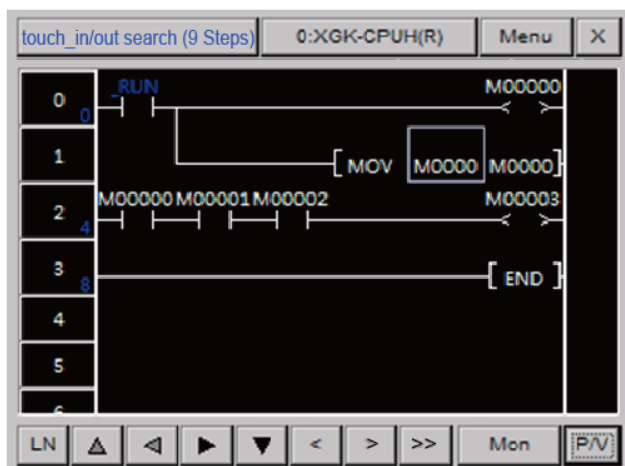

Note

This function uses the inclusion relationship between the data types of commands for searching. For the data types of command, refer to PLC user's manual.

1.5 Configuring Options

Configure various settings of the Program Monitor.

To configure the options:

1 In the Program Monitor window, tap [Menu].

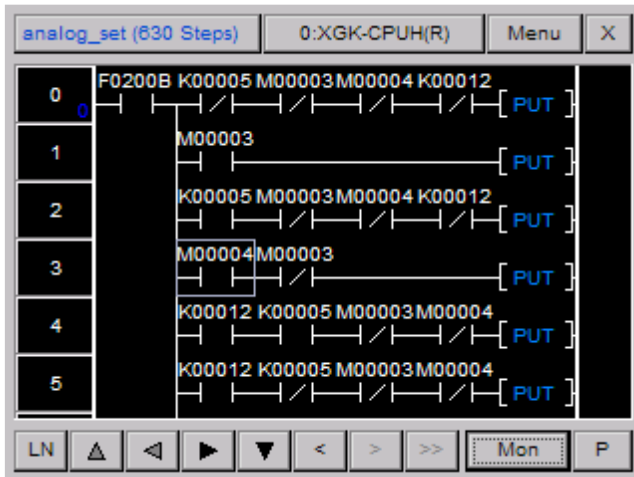

2 Tap [Option] to open the Option window.

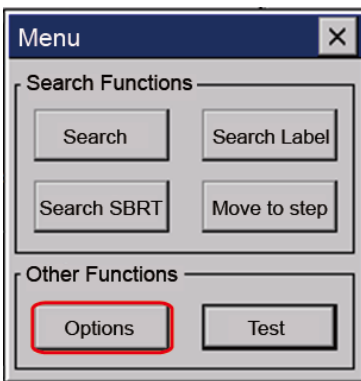

3 Touch a tab to view or change the following information.

- **File:** The File tab allows you to set where to save files.

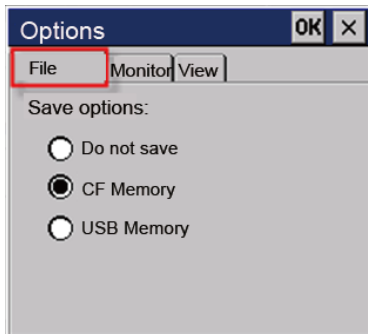

- **Save Option:** Set where to save files.
- **Monitor:** The Monitor tab allows you to choose a display format.

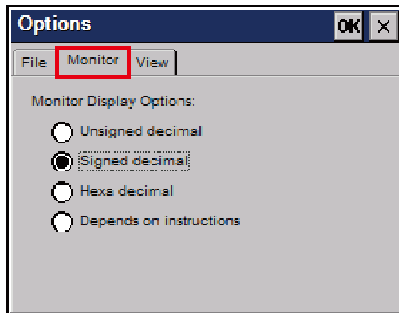

- **Monitor Display Options:** Set the display format.
- **View:** The View tab allows you to change the LD options.

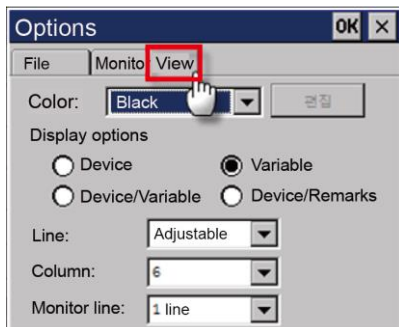

- **Color:** Set the color for the LD program.
- **Display Options:** Set the display type of a device in the Program Monitor.
- **Line:** Set the number of lines to display devices, variables, or descriptions. If you select Variable, all data are displayed. If you select a certain line, only that line will be displayed. If the total number of lines is bigger than the selected number of lines, will be displayed.
- **Column:** Set the number of columns to display on the screen. If you select the minimum number of columns, all items will be displayed except the output descriptions.
- **Monitor Line:** Set the monitor display line of commands. If you select 0 Line, the current monitor value of commands will not be displayed. This option is useful when you want to monitor only ON/OFF of a contact.

2 NC Program Monitor

By monitoring the NC program of the PLC connected to the HMI, can easily diagnose the PLC program status and errors.

2.1 Start

1 NC Program drive download.

Download NC monitor program using XP-Manager.

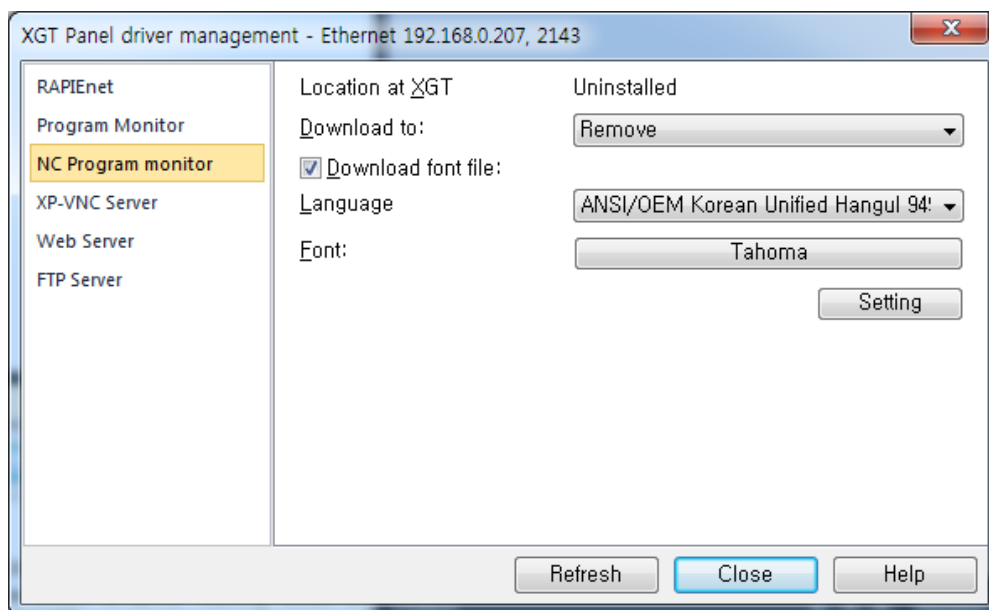
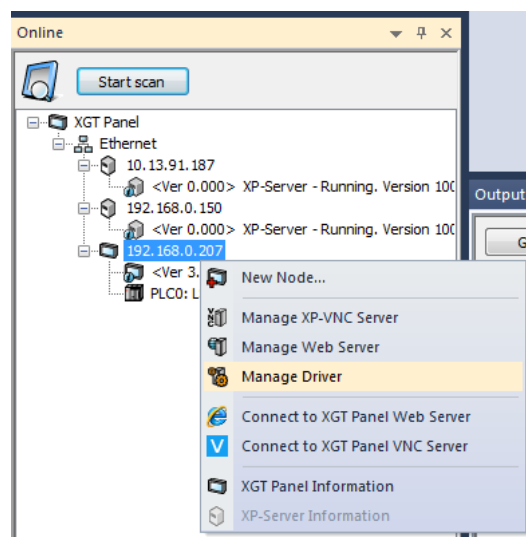

2 Add switch for NC program execution

After downloading NC Program monitor, create special switch to execute NC monitor program through XP-Builder.

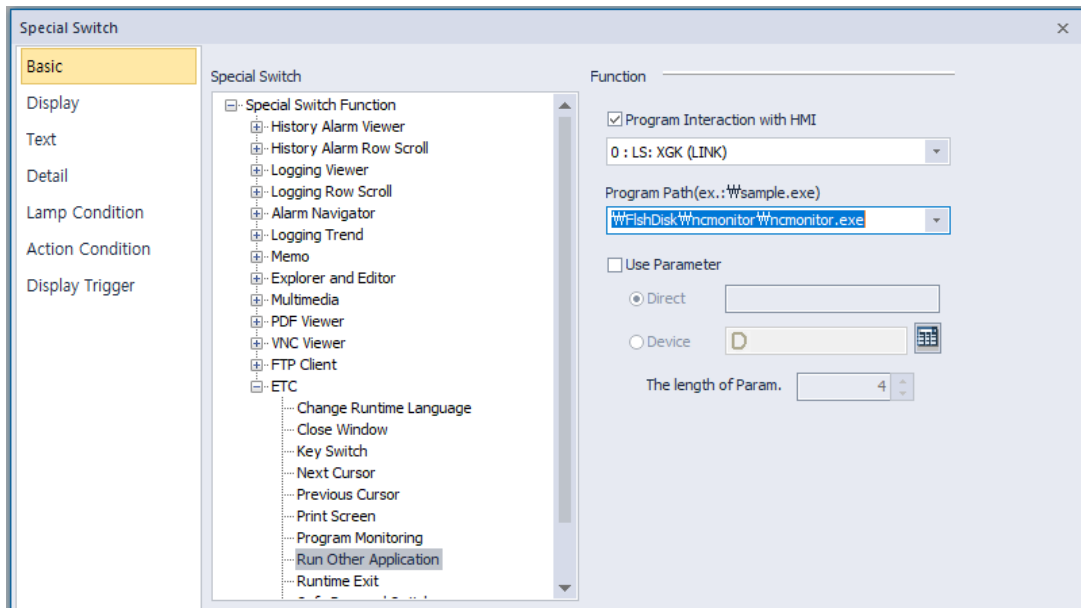

- Program Interaction with HMI: Check it.
- Program Path: Run NCMonitor.exe in the path downloaded in step 1 above. For example, if you downloaded the program to FlashDisk, set it to \FlashDisk\NCMonitor\NCMonitor.exe.

2.2 Run at wXP

1 Install XG5000. (XG5000 V4.20 or later)

2 Add switch for NC program execution

- Program Interaction with HMI: Uncheck it.

- Program Path: Run NCMonitor.exe in the path location where wXP is installed. For example, if the program is installed in C:\program files\LS\wXP\NCMonitor\NCMonitor.exe

3 IP setting

Specify the IP in the UserSettings.inf file in the path where wXP is installed. For example, if you installed wXP in C:\Program Files\LS\wXP\NCMonitor\UserSettings.inf.

```

1 [UserFlagInfo]
2   _07_PROGRAM_NAME=128
3 [PLC]
4   IP=192.168.250.110
5

```

- Special switch: Set as shown below.

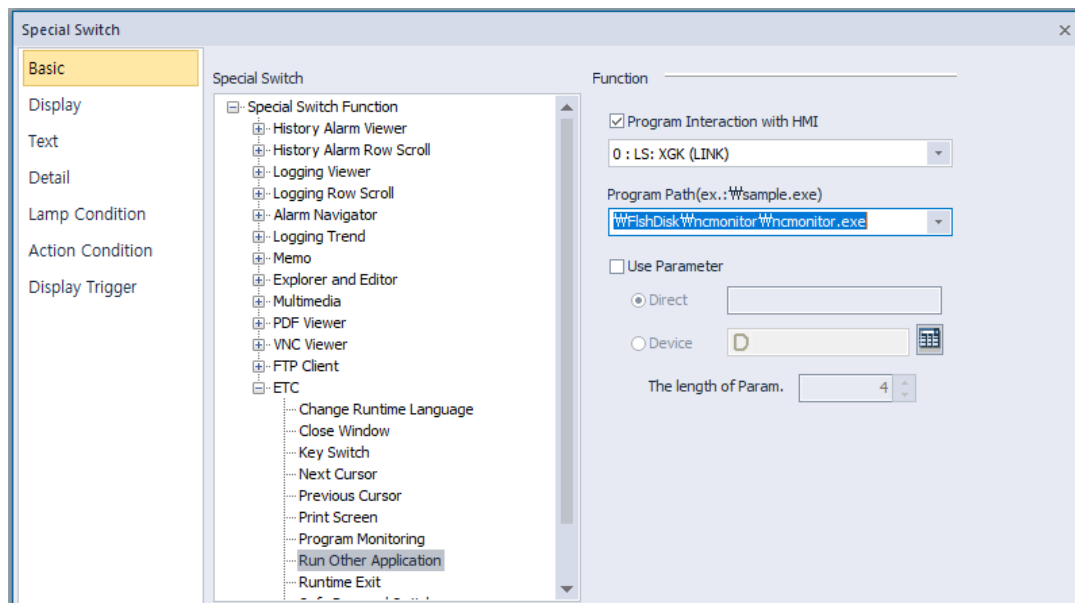

- Program Interaction with HMI: Check it.

- Program Path: Run NCMonitor.exe in the path downloaded in step 1 above. For example, if you downloaded the program to FlashDisk, set it to \FlashDisk\NCMonitor\NCMonitor.exe.

2.3 NC Monitoring Program Features

Able to monitor the devices not currently used in the program and check the status of the PLC.

2.3.1 NC monitoring program description

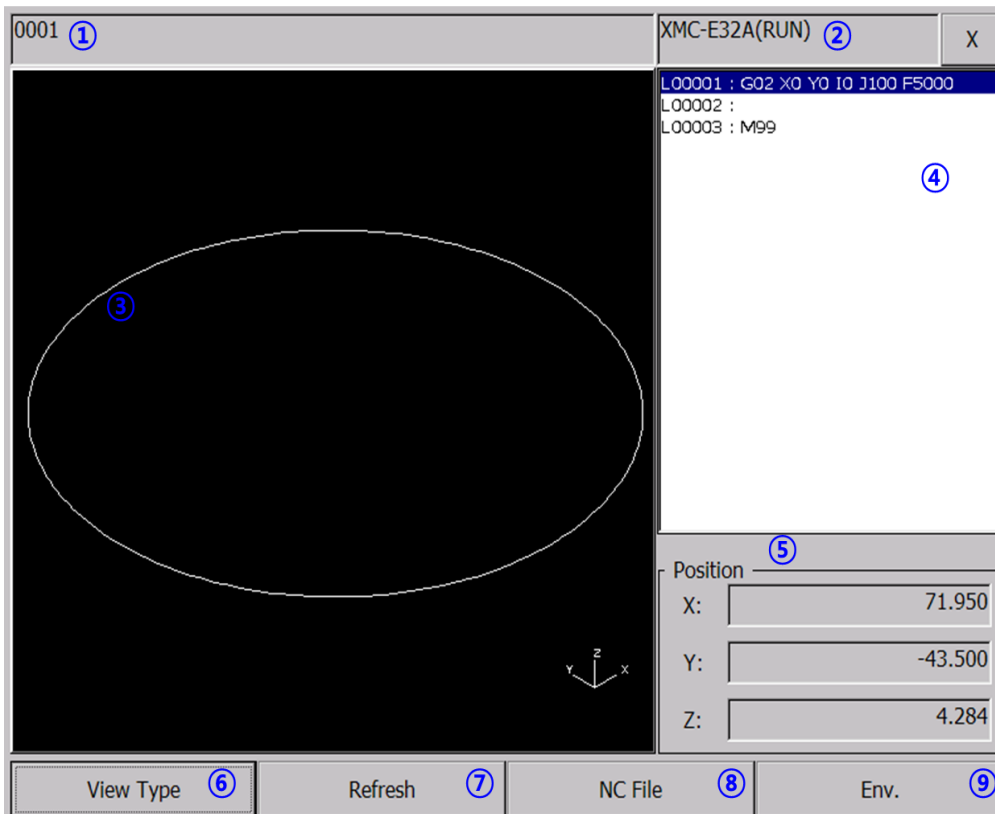

- 1 Display the currently running NC program.
- 2 Display connected PLC type and operation status.
- 3 Display the toolpath program.
- 4 The NC program currently running is displayed.
- 5 Display the current position value of the work piece coordinate.
- 6 Change the view mode of the toolpath graph. IS090 – XY – YZ – ZX is displayed in sequence.
- 7 Re-read NC programs and parameters from the PLC. It is used when NC program is newly downloaded from XG5000.
- 8 Manage NC files.
- 9 Set the device to connect with the function button.

2.3.2 User Device Setting

It is used when you want to control PLC program by button.

Specify the device to name the selected NC program.

Category	Device
Program Name	%MD4

71.950
-43.500
4.284

Default OK Cancel

View Type Refresh NC File Env.

2.3.3 NC file Management

Manage NC files saved in the PLC. Using this feature, you can select NC program to operate and delete, load and export files.

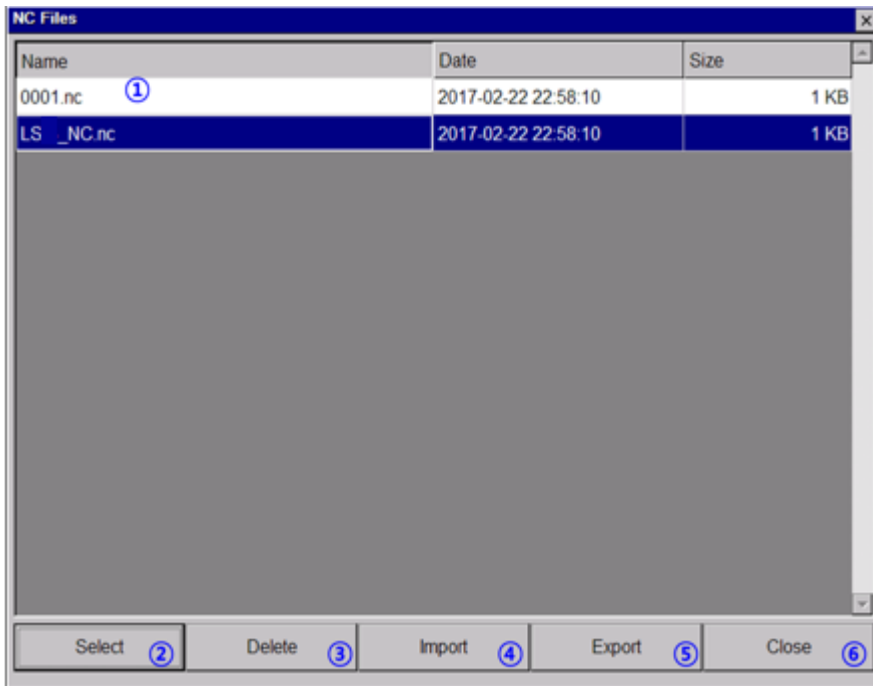

- 1 Display file list.
- 2 Write the selected NC program to the program name specified in [Preferences].
- 3 Deleted the selected NC file.
- 4 Import the NC file from the removable storage device.
- 5 Export the selected NC file to a removable storage device.
- 6 Close the dialog.

2.3.4 Import NC file

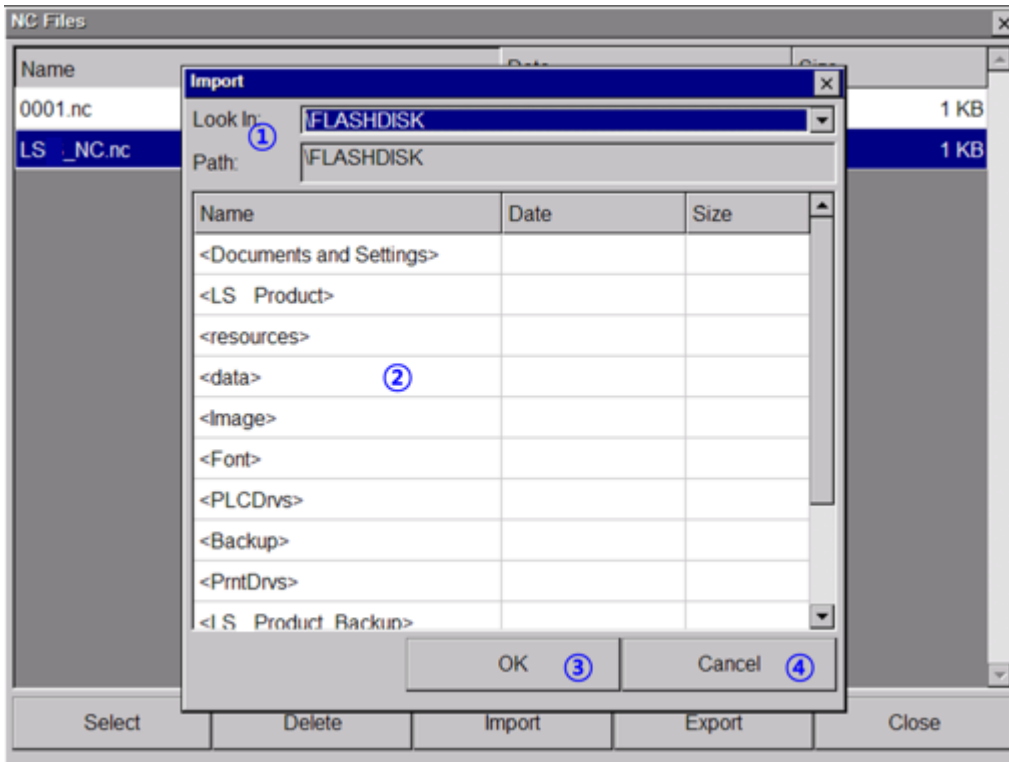

- 1 Display the drive list in the XGT Panel.
- 2 Displays a list of subfolders and NC files in the currently selected folder.
- 3 Select the NC file to import and close the dialog.
- 4 Cancel the load operation.

Deleting and importing loads the NC program again. NC program is applied only in the stop mode and needs to be converted. However, it can be operated normally only when the key switch of PLC is remote mode.

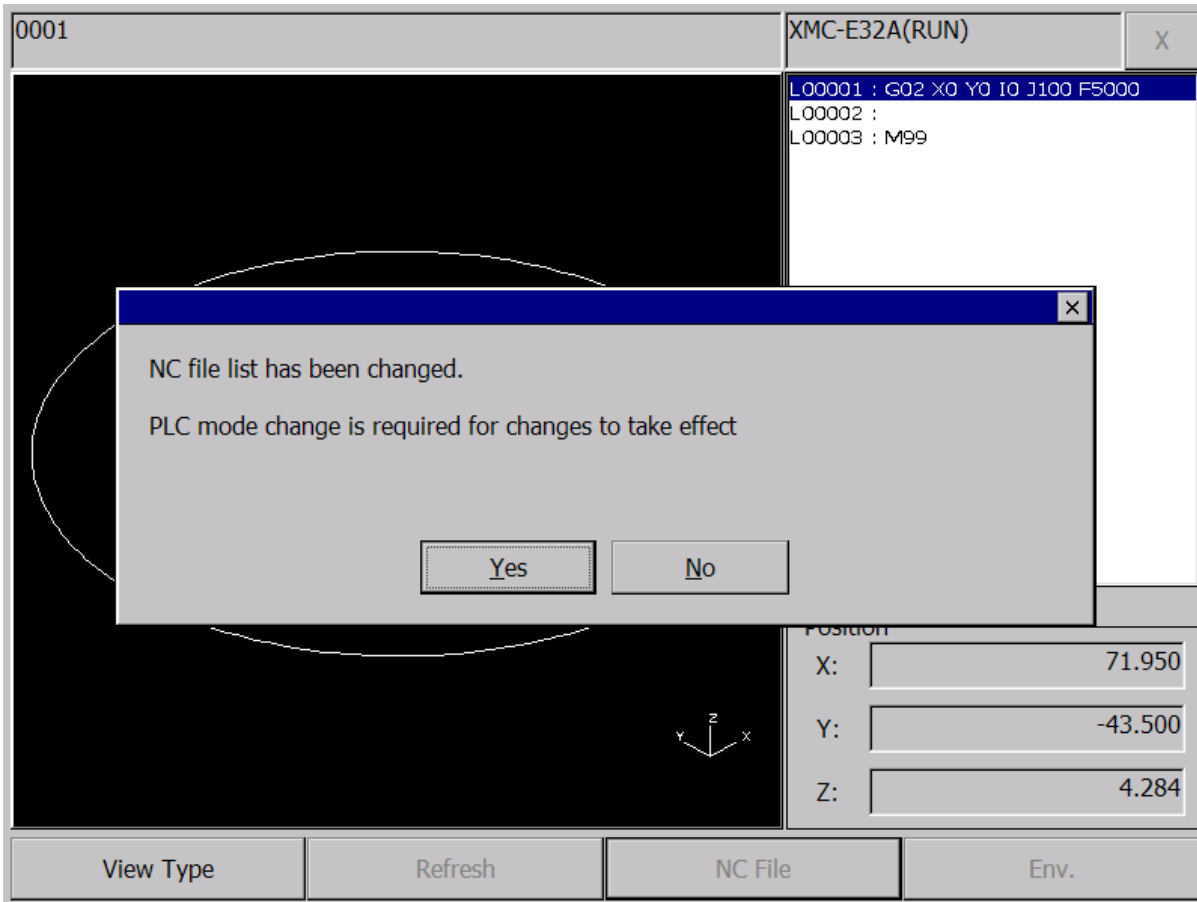

2.3.5 Change View Mode

The NC monitor supports four viewing modes. Each time you press the View Type button, the for modes, ISO90 – XY – YX – ZX, change in sequence.

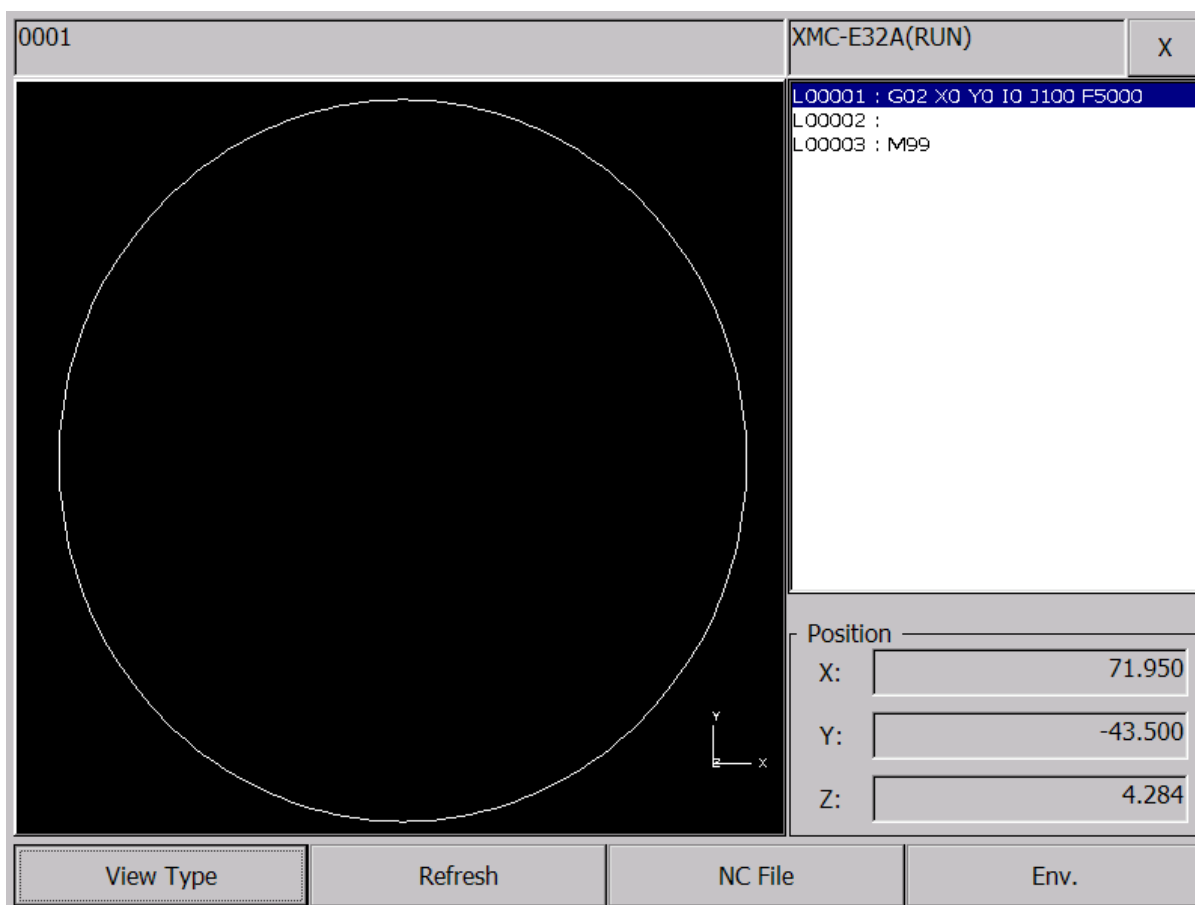

2.4 Edit NC Program

Edit NC program is only available at wXP.

2.4.1 Preparation

Program editing is a separate external program. Notepad++ is recommended to take advantage of the Syntax Highlight feature of NC code (notepad++ is freeware available for download from <https://notepad-plus-plus.org>).

1 Enable NC Syntax Highlight feature

Select menu in Notepad++ [Language] – [Define Your Language ...]. In the dialog below, click the button [Import...] to select the NC language definition file for XMC (file name G-CODE_XG.XML). The file exists in the installed NC monitor program installation path.

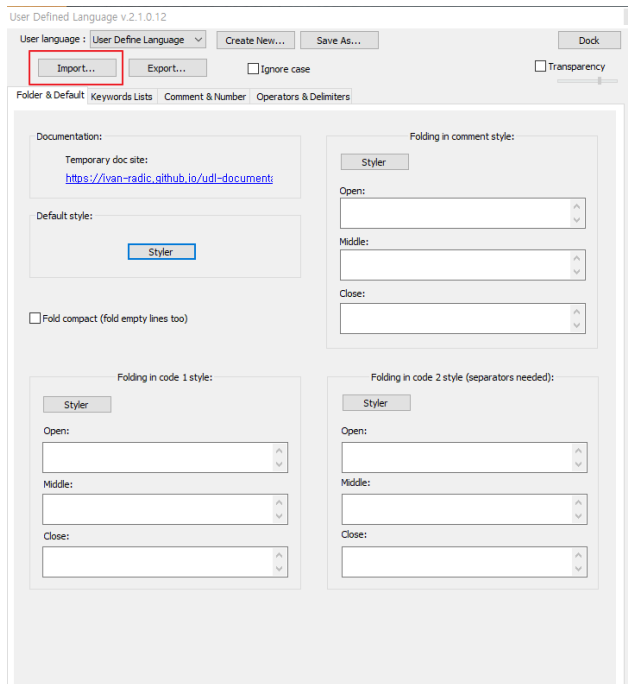

If you run notepad++ again after importing the file, you can see that the GCODE item is added as shown below.

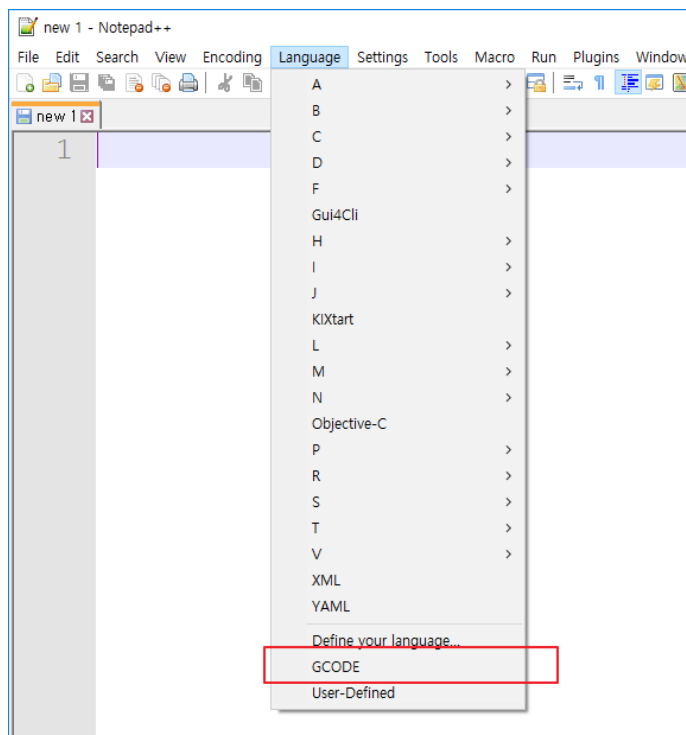

2 Specify the editor path.

NC Editor is set in the UserSettings.inf file. Open the file and specify the path where notepad++ is installed. The following is an example of installing Notepad++ in the path C:\Program Files(x86)\Notepad++.

3 Select the NC file to import and close the dialog.

4 Cancel the import operation.

[Editor]

```
PATH = C:\Program Files(X86)\Notepad\Notepad.exe
```

```
ARG1=-nosession
```

```
ARG2=-nosession -n%d
```

2.4.2 Overview

Click menu [NC File] to display the file list. Select the program you want to edit from the file list and click the [Edit] button.

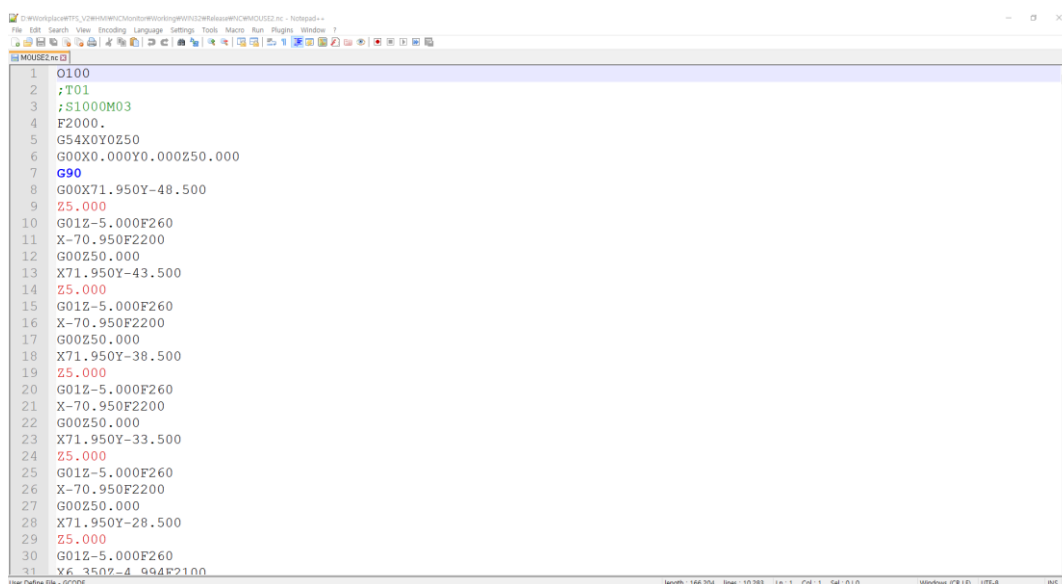

If the file is edited and you exit the NC File Manager, you check whether the changed file is written to the PLC. The procedure below is the same as importing an NC file.

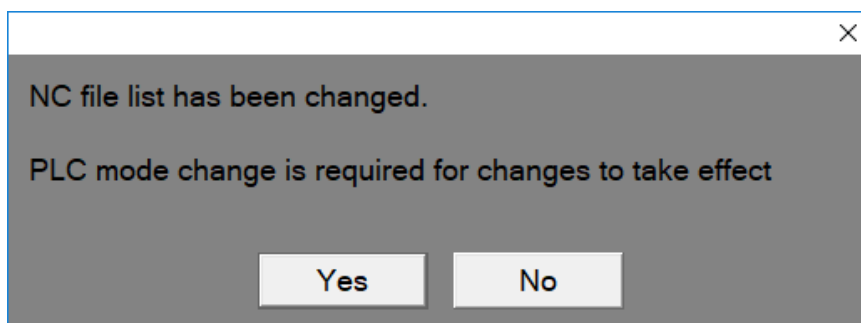

If there is a contact error in the NC file, an error dialog box appears as shown below. After selecting the line where the error occurred, click the [Edit] button to edit it again.

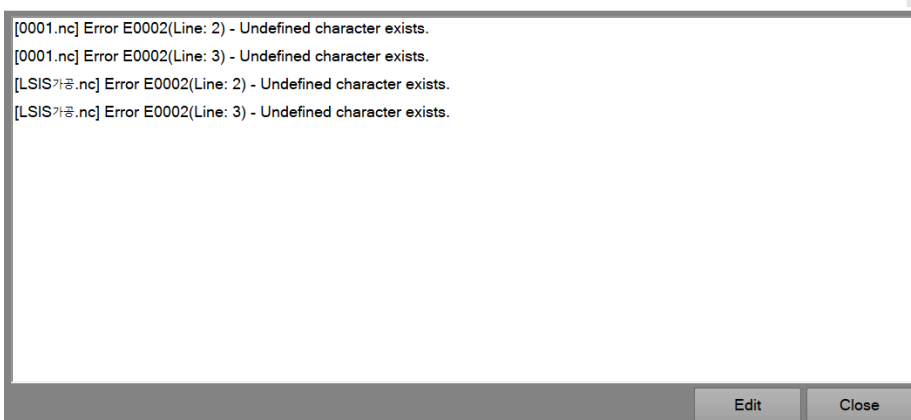

3 Autoscan

Autoscan is able to check the configuration and module status of the network system consisting of RAPIEnet I/F modules of the PLC connected to the HMI device, and measure the cable distance.

Note

Cable distance measurement may vary depending on the configuration of the network system. For the details, please refer to RAPIEnet I/F module user manual.

3.1 Start Autoscan

3.1.1 Overview

Download Autoscan program using XP-Manager. After selecting the Manager Driver of the device to use Autoscan in XP-Manager, select Autoscan.

- When running the Autoscan program in Korean: After setting [Download Font File], set it to [ANSI/OEM Korean Unified Hangeul 949], and then specify a font that supports Korean, such as [Gulim].
- When running the Autoscan program in English: After setting [Download Font File], set it to [ANSI Latin 1 1252], and then specify a font that supports English such as [Tahoma].

If the selected font file and whether the font is Korean or English do not match, the language of the autoscan program may appear broken on the machine.

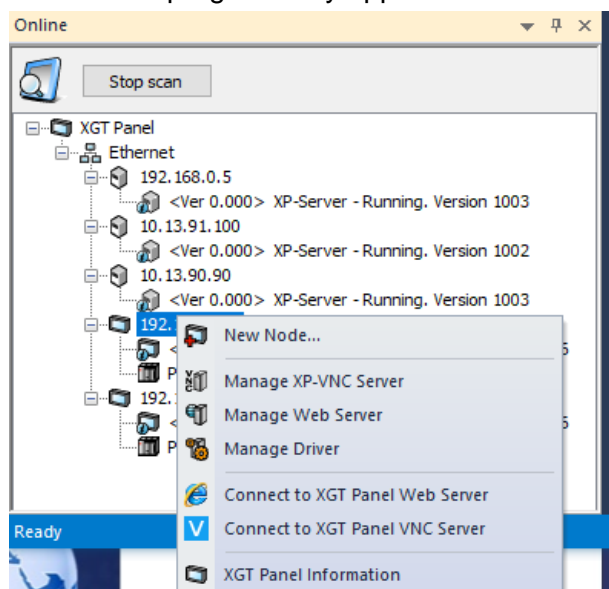

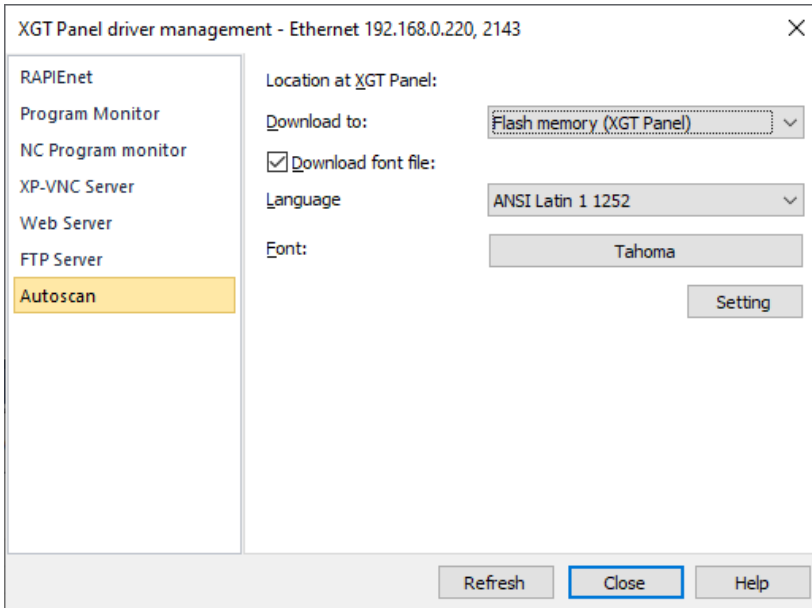

3.1.2 Add special switch to operate Autoscan program

After downloading the Autoscan program, create a special switch that can executed Autoscan through XP-Builder. If downloaded to FlashDisk from XP-Manager, the program path is \FlashDisk\AutoScan.exe.

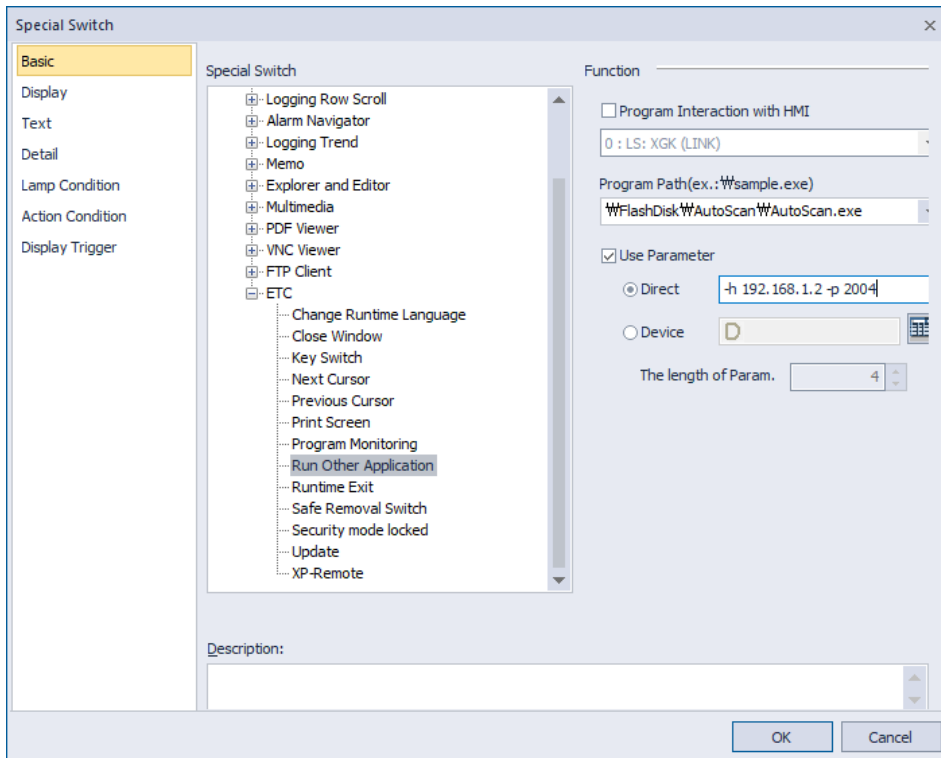

- Program Interaction with HMI: Do no set.
- Program Path: Run AutoScan.exe in the path downloaded in step 1 above. For example, if you downloaded the program to FlashDisk, set it to \FlashDisk\AutoScan\AutoScan.exe.
- Use Parameter: Set when registering PLC IP connect. If the parameter is not used, the default IP is 192.168.1.2, Port is 2004. The monitoring period is 1 second.

- Direct: Register the IP and port number of the PLC to be connected. For example, if you connect with IP: 192.168.1.2, Port: 2004, set `-h 192.168.1.2 -p 2004`. When setting the monitoring period, specify the period (unit: second) after `-t`. If the period is 2 seconds, set `-h 192.168.1.2 -p 2004 -t2`.

Note

When setting the Program Interaction with HMI, the runtime running on the machine is stopped and only external programs set by the user are executed. If the setting is checked, it may appear that the machine is malfunctioning when executing an external program, but in reality only the set external program is executed and the runtime is not operated.

3.2 Using in wXP

1 Install XG5000 (XG5000 version 4.20 or later).

2 Add a special switch to executed Autoscan program.

- Program Interaction with HMI: Do no set.

- Program Path: Run AutoScan.exe from the location where wXP is installed. For example, if you installed the program in C:\Program Files\LS, set it to \C:\Program Files\LS\AutoScan\AutoScan.exe.

- Parameter: Set when registering PLC IP connect. If the parameter is not used, the default IP is 192.168.1.2, Port is 2004. The monitoring period is 1 second.

- Direct: Register the IP and port number of the PLC to be connected. For example, if you connect with IP: 192.168.1.2, Port: 2004, set `-h 192.168.1.2 -p 2004`. When setting the monitoring, specify the period (unit: second) after `-t`. If the period is 2 seconds, set `-h 192.168.1.2 -p 2004 -t2`.

3 IP Setting

When adding a special switch for running the Autoscan program, you can set the PLC and IP to be connected, but you can also set the IP through the IP setting screen by clicking the setting button after running the Autoscan program. The default IP is 192.168.1.2 and the port number is 2004. After registering the IP of PLC to be connected in the IP setting screen, click the Apply button to save it as a file. For example, if you installed wXP in C:\Program Files\LS, it will be saved in the \C:\Program Files\LS\wXP\AutoScan\IPList.xml file.

Setting

IP & Port

Label:

IP:

Port:

Label	IP Address	IP Port
IP2	192.168.0.20	2004
IP1	192.168.1.2	2004

Monitoring

Period: (sec)

```

1  <?xml version="1.0" ?>
2  <IPList>
3      <Monitoring Period="1" />
4      <CurrentHost Label="IP1" IP="192.168.1.2" Port="2004" />
5      <Host Label="IP1" IP="192.168.1.2" Port="2004" />
6      <Host Label="IP2" IP="192.168.1.3" Port="2004" />
7  </IPList>
8

```

3.3 Features of Autoscan

Able to check the network system configuration status consisting of the RAPIEnet I/O module of the PLC connected to the HMI.

3.3.1 Autoscan program menu



Item	Description
AutoScan – IP: Port: Period	Displays the IP, Port number and monitoring period of the connected PLC.
Network Information - Station No.	Displays the quantity of the RAPIEnet I/F modules of the connected network. - Range: 0~63
Network Information - Topology/Set	Displays setting of the system network configuration status and user topology setting. - LINE: Line type network configuration. - RING: Ring type network configuration. The network configuration is depend on the RAPIEnet protocol. For details, please refer to the RAPIEnet I/F user manual.
Network Information – Collision	When two or more of the modules to be connected on the network have the same station number, the collision station number is displayed.

Item	Description
Setting	Set the IP, Port number and monitoring period of the PLC to be connected.
Save	Save the current network system configuration status.
Slave Diagnostic	Executes the slave diagnostic.
Goto Local	Change the MRS autoscan screen to the local autoscan screen.
Compare	The status of the added/deleted/changed is displayed by comparing the previously saved network system configuration status with the current network configuration status.
Cable Distance	Displays the cable distance between the RAPIEnet I/F of the PLC that connected to HMI.
Autoscan status screen	Displays network status on screen.
Progress Bar	Displays the progress on the progress bar.
Cable Deletion/Cable Addition	Displays index for the Autoscan screen. Red when the cable is removed, and blue when a cable is added.
Show User Topology	Displays the compare result of the user topology when it checked.
Monitoring	The current network system configuration status is periodically updated and displayed.
Retry	Displays the current network system configuration status by updating once.
Close	Closes the Autoscan program screen.

3.3.2 IP setting and monitoring period setting

It is used when setting the IP and port number of the PLC to be connected and the monitoring period. After running the Autoscan program, click the [Setting] button to display the setting screen.

Setting

IP & Port

Label:

IP:

Port:

Label	IP Address	IP Port
IP2	192.168.0.20	2004
IP1	192.168.1.2	2004

Monitoring

Period: (sec)

Item	Description
Label	The label for IP and port number of the PLC to be registered is displayed. When touched, the keyboard screen is displayed and you can set the label.
IP	Displays the IP of the PLC to be registered.
Set	Displays the IP input. When IP input is complete, IP setting items are changed.
Port	The port information of the PLC to be registered is displayed. When touched, the keyboard screen is displayed and the port number can be set.
List	Displays the PLC list.
Add/Edit	Label, IP, Port number contents are applied in PLC list. If the same label exists in the list, it is edited, otherwise it is added to the list.
Delete	Deletes the selected information from the registered PLC list.
Monitoring Period	Displays monitoring period. Unit is seconds and the range is 1 to 10.
Apply	Save the settings and close the dialog box. If the same label exists in the PLC list, it is changed to the set contents.
Close	Closed the dialog without saving the settings.

3.3.3 Save network status

Saves the current network system configuration status. Clicking the [Save] button saves the current network system configuration status, and the progress is displayed as a progress bar. In the MAR autoscan screen, it is not possible to save the network system configuration status, so the [Save] button is disabled.



3.3.4 Slave Diagnostic

Executes slave diagnostic. Click the [Slave Diagnostic] button to diagnose the current network system configuration and display the error details.

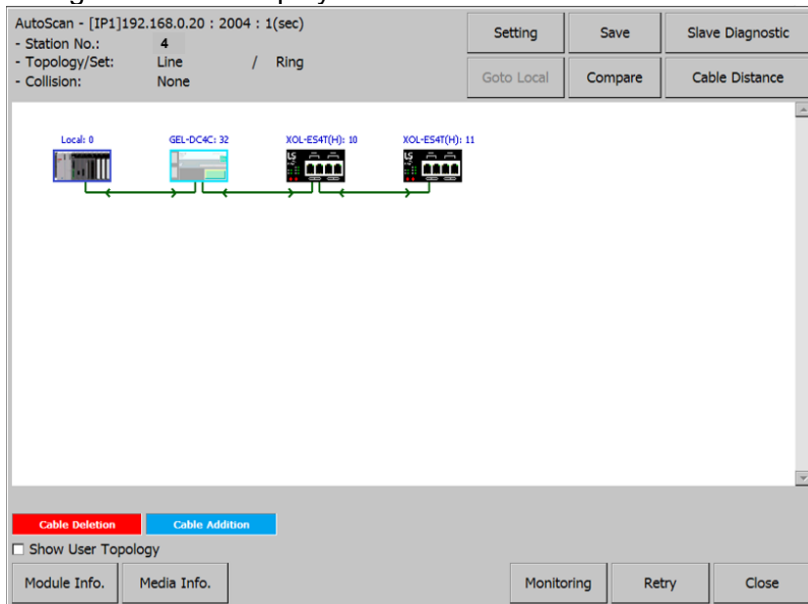

3.3.5 Goto Local

Changes from the MRS autoscan screen to the local autoscan screen. The [Goto Local] button is activated only in the MRS autoscan screen mode. Clicking the button changes to the local autoscan screen. The figure below shows the MRS autoscan screen.

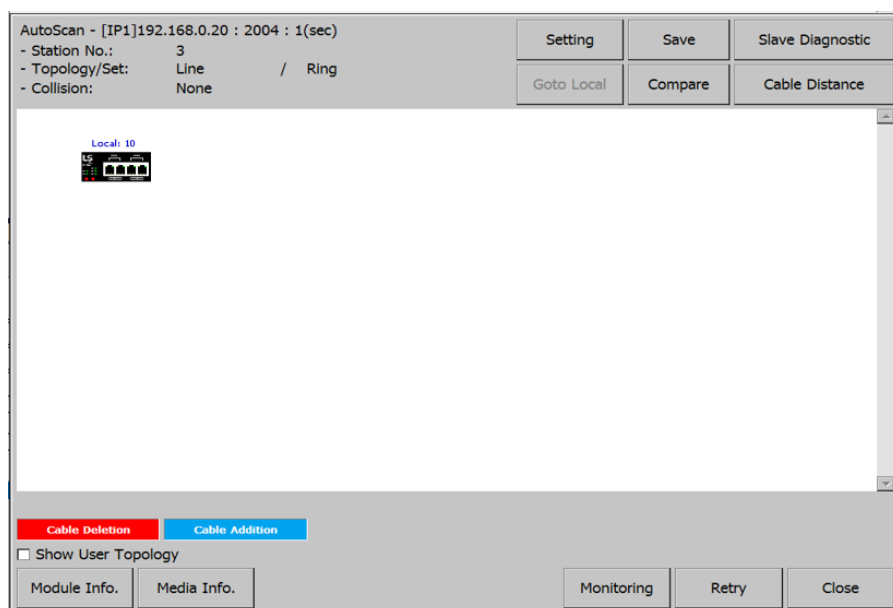

3.3.6 Compare

Compares the previously saved network system configuration status with the current network system configuration status and displays the status of addition/deletion/change. Clicking the [Compare] button changes to the [Stop] and displays the comparison result. Clicking the [Stop] button ends the Compare function. In the MRS Auto Scan screen, it is not possible to save the network system configuration status, so the [Compare] button is disabled.

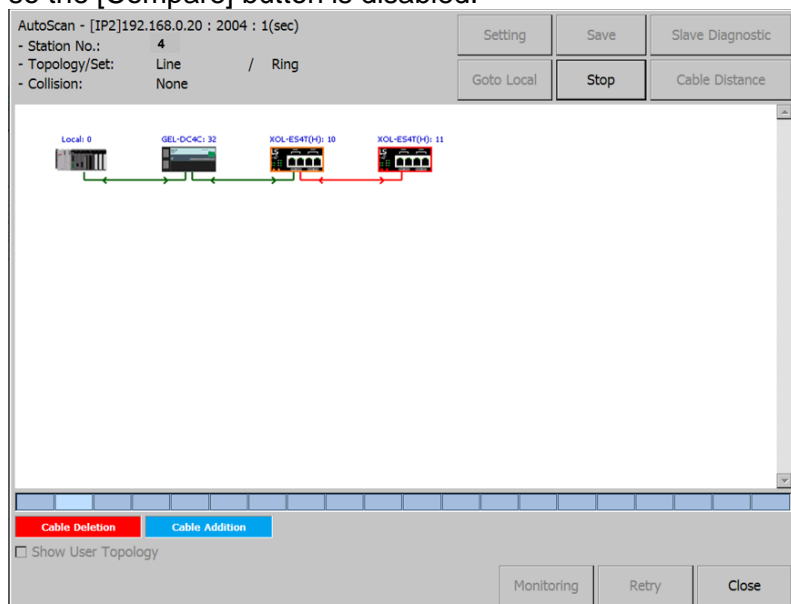

3.3.7 Cable Distance

You can measure the cable distance between the HMI device and the RAPIenet I/F module of the connected PLC. Clicking [Cable Distance] displays the measured cable distance along with the measured date as shown below. Optical cables cannot be measured, so they are marked as Fiber Optic.



To display the measured cable distance, first do as follows. If you display the cable distance in Autoscan without following the method below, the cable distance may be displayed incorrectly.

<Method of measuring cable distance>

- (a) Configure the system and connect cables.
- (b) Turn on the power and check if the Link LEDs of all RAPIenet I/F modules to which cables are connected are on.
- (c) Remove the cable from the electrical port of the module where the Link Led is on, and reconnect after 5~10 seconds.
- (d) Carry out (c) for all modules on the network or modules to measure cable distance. However, do not attach or detach both ports at the same time.
- (e) After performing (c) on the cable to measure the distance, click [Cable Distance] on the Auto Scan screen.

3.3.8 Monitoring

The current network system configuration status is periodically updated and displayed. If you click the [Monitoring] button, it changes to the [Stop] button, and the network status is periodically updated and displayed, and the progress is displayed as a progress bar. The update period is set in the monitoring period (unit: second) in the setting screen. Click the [Stop] button to end the monitoring function.



3.3.9 Remote module status information diagnostic

Diagnosis service is performed on the module of the station number displayed on the autoscan. If you click the station number to perform diagnosis service on the auto scan screen, the diagnosis service button is displayed at the bottom as shown in the figure below.

The figure below show the clicked MRS node.

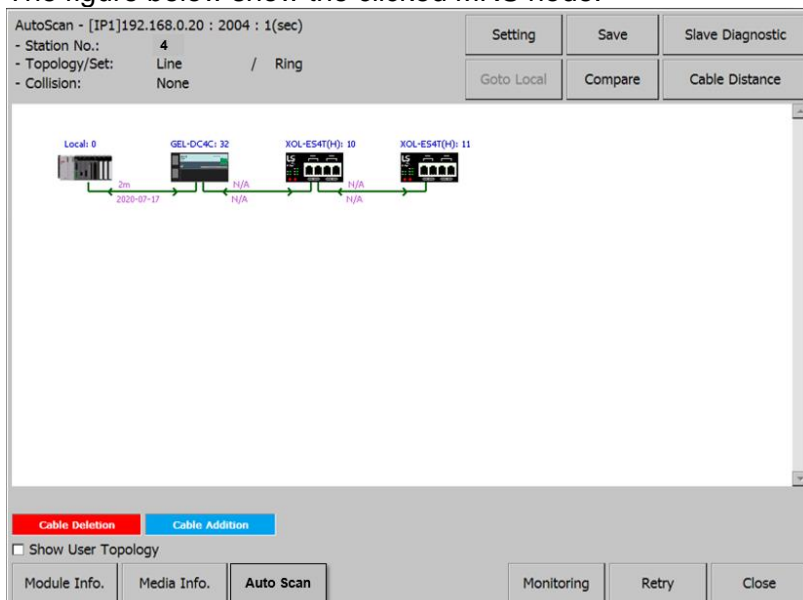

Item	Description
Module Info.	Displays remote communication module information. If you click the [Module info.] button, the communication mode information dialog box for the MRS node is displayed as shown below. Clicking the [Retry] button changes the communication module information to the latest status. Clicking the [Close] button closes the dialog box.

Item	Description
<p>Media Info.</p>	<div data-bbox="384 331 1209 931"> </div> <p>Displays remote media information. Clicking the [Media Info.] button displays the media information dialog box for the remote I/O node as shown below. If you click the [Monitoring] button, the media information is periodically updated. Click the [Retry] button to update the media information. Clicking the [Close] button closes the dialog box.</p> <div data-bbox="384 1126 1182 1576"> </div>
<p>Autoscan</p>	<p>Perform MRS auto scan. Switches to the screen showing the IP list connected under the selected MRS. Click the [Goto Local] button to switch to the local autoscan screen.</p>

Item	Description
	 <p>The screenshot shows the 'AutoScan' window with the following details:</p> <ul style="list-style-type: none"> AutoScan - [IP1]192.168.0.20 : 2004 : 1(sec) - Station No.: 4 - Topology/Set: Line / Ring - Collision: None <p>Buttons visible include: Setting, Save, Slave Diagnostic, Goto Local, Compare, Cable Distance, Cable Deletion, Cable Addition, Show User Topology (checkbox), Module Info, Media Info, Auto Scan, Monitoring, Retry, and Close.</p>

The figure below show the clicked remote I/O node.

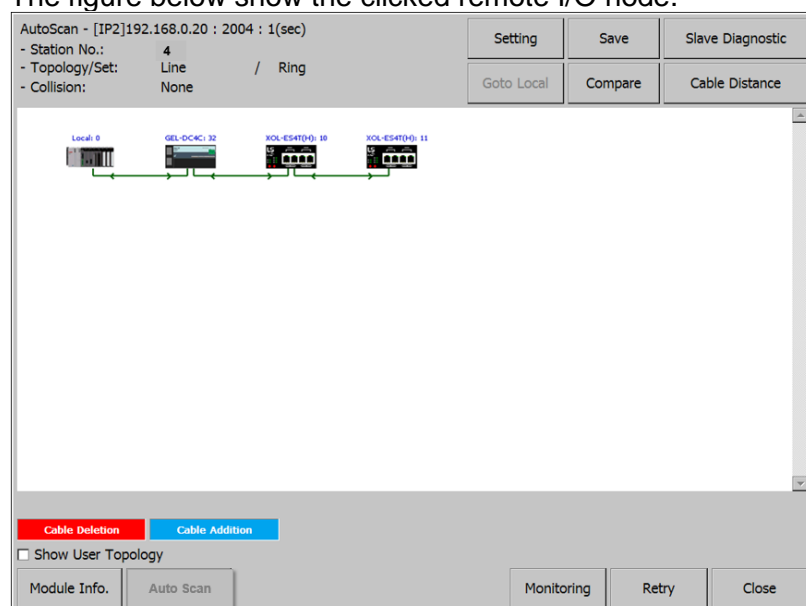

Item	Description
Module Info.	Displays remote communication module information. If you click the [Module info.] button, the communication mode information dialog box for the remote I/O node is displayed as shown below. Clicking the [Retry] button changes the communication module information to the latest status. Clicking the [Close] button closes the dialog box.

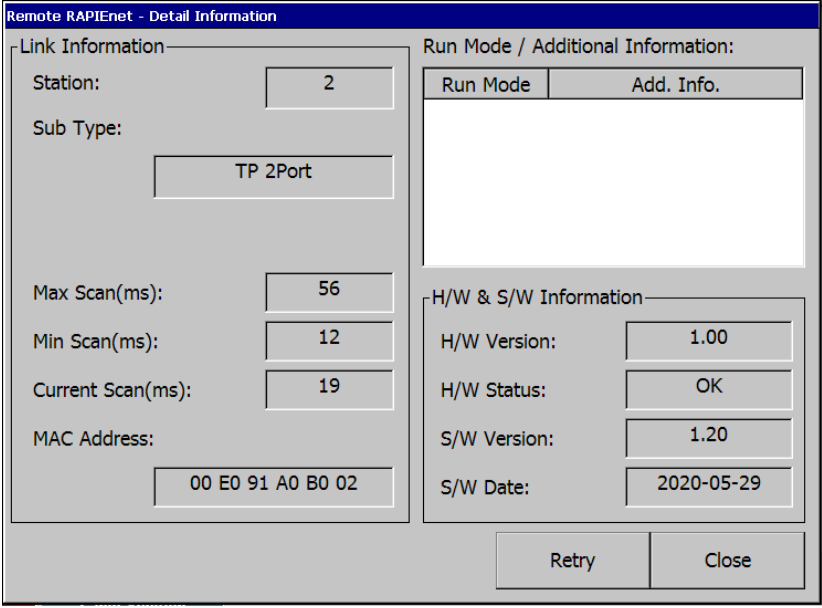
Item	Description
Media Info.	 <p>Displays remote media information. In case of the remote I/O note, the button will be deactivated.</p>

The figure below show the clicked local node.

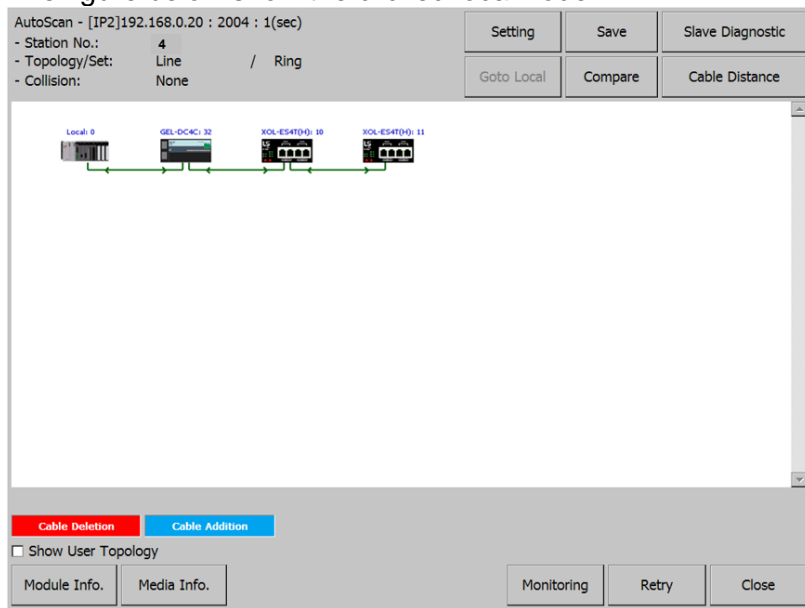

Item	Description
Module Info.	<p>Displays remote communication module information. If you click the [Module info.] button, the communication mode information dialog box for the local node is displayed as shown below. Clicking the [Retry] button changes the communication module information to the latest status. Clicking the [Close] button closes the dialog box.</p>

Item **Description**

Media Info.

Displays remote media information. Clicking the [Media Info.] button displays the media information dialog box for the local note as shown below. If you click the [Monitoring] button, the media information is periodically updated. Click the [Retry] button to update the media information. Clicking the [Close] button closes the dialog box.

Item	Details	Description
Service Status Information	XGT Server	Total number of frames transmitted/received by XGT server service.
	HS. Link	Total number of frames transmitted/received by high speed link service.
	P2P(EIP)	Total number of frames transmitted/received by P2P service
	Etc	Total number of frames transmitted and received by other services
Media Status	Broadcast	The number of packets per second for

Item	Description	
	Information (packet/sec)	frames sent and received by broadcast
	Multicast	The number of packets per second of frames transmitted and received by multicast
	Unicast	The number of packets per second of frames sent and received by unicast
	Group Trans.	The number of packets per second of frames transmitted and received by group transmission
Packet Monitoring (packet/sec)	Transmit	The number of packets per second in frames sent on each port
	Receive	Packets per second of frames received on each port
	Relay	Packets per second of frames relayed on each port
	Error	The number of packets per second of errors that occur during transmission/reception on each port

When an error occurs in the frame transmitted or received from the RAPIenet I/F module, you can check the detailed information of the error. Media information screen If the error count is 1 or more among the contents of packet monitoring, the [Detail Error] button is activated. Clicking the [Detail Error] button opens the packet monitoring details screen. For each error, you can check the number of error packets per port.

	PORT 1	PORT 2
Tx_Retry_Over Cnt	0	0
Dealy Collision Detect Cnt	0	0
Lost Carrier Cnt	0	0
Carrier Not Detect Cnt	0	0
CRC Error Frame Receive Cnt	2688	0
Frame Receive Error Cnt	1660	0
Too Short Frame Cnt	0	0
Too Long Frame Cnt	0	0
Residual Bit Frame Cnt	10601	0

Buttons: Flag Clear, Retry, Close

Item	Description
Tx_Retry_Over Cnt	Number of frames that cannot be transmitted even after 16 retransmissions
Delay Collision Detect Cnt	Number of delayed collisions on the line after transmission

Item	Description	
	Lost Carrier Cnt	Number of times carrier loss occurred during transmission
	Carrier Not Detected Cnt	Number of times a carrier was not detected during preamble transmission
	CRC Error Frame Receive Cnt	Number of occurrences of frames in which CRC errors were received
	Frame Receive Error Cnt	Number of frames with reception error
	Too-Short Frame Cnt	Number of received frames less than 64 bytes
	Too-Long Frame Cnt	Number of received frames greater than 1518 bytes
	Residual-Bit Frame Cnt	Number of received frames including Residual-Bit

4 XP-VSP

4.1 About XP-VSP

XP-VSP is software that enables data communication between the ladder software of a remote PC and the PLC connected to the XGP panel. The features of XP-VSP include the following.

- Supports virtual serial ports
- Supports TCP/IP technology
- Supports various COM ports at the same time
- Allows using of user-created files that are already downloaded
- Shows the availability of drivers

4.1.1 Overview

XP-VSP enables data communication between the ladder software and the PLC using the TCP/IP technology and the Virtual serial port technology.

The illustration below describes how the ladder software and the PLC communicate using the TCP/IP technology.

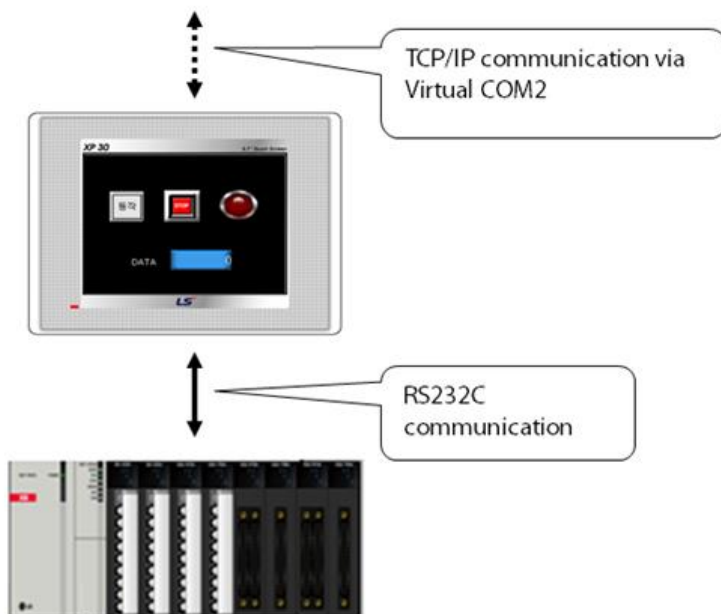
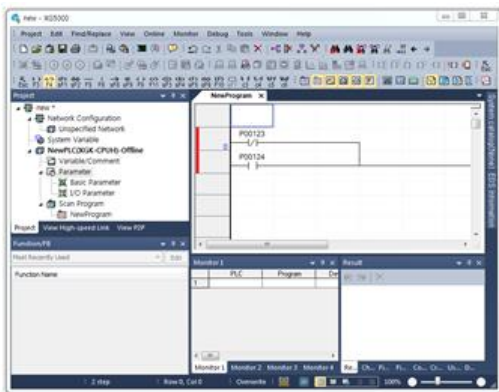

- 1 The ladder software of the computer uses a virtual com port.
- 2 The virtual com port sends data to TCP/IP.
- 3 The XGT panel receives data from the TCP/IP server.
- 4 The data is sent to and received from the PLC via RS232C.
- 5 The TCP/IP server of the XGT panel sends data to the computer.
- 6 The ladder software receives data.

4.1.2 Supported PLC Drivers

XP-VSP supports the drivers that support the PLC loader protocol.

The following drivers are supported.

Manufacturer	Driver
LS	GLOFA GM series CPU Direct
	Master-K series CPU Direct
	XGK series CPU Direct
	XGB series CPU Direct
	XGI series CPU Direct
	XGR series CPU Direct
Omron Corporation	CS/CJ Host Link serial
YASKAWA	MEMOBUS RTU Master

4.2 Installing and Updating

This section explains how to install and update the XP-VSP software.

4.2.1 Installing XP-VSP

You may install XP-VSP on a PC that meets the following minimum system requirements.

- Processor: Pentium 4 or higher
- Memory: 512MB or more free memory
- COM Ports: Ethernet port
- Hard Disk: 1GB capacity or higher
- Monitor: Minimum resolution of 1024x768
- OS: Windows XP, Windows 2000, Windows 7, Windows 8, Windows 10
- Peripherals: Mouse and keyboard

To install XP-VSP:

- 1 Run the XP-VSP setup file.

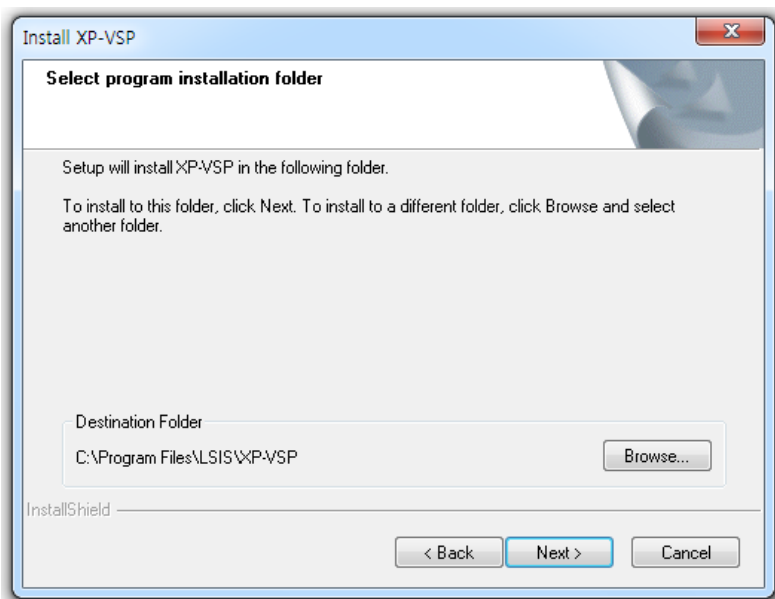

- 2 Follow the instructions in the installation wizard to complete the installation.

4.2.2 Updating XP-VSP

To update XP-VSP:

- 1 Run the XP-VSP setup file of a new version with the old version already installed.
- 2 Select **Reinstall** and click **Next**.

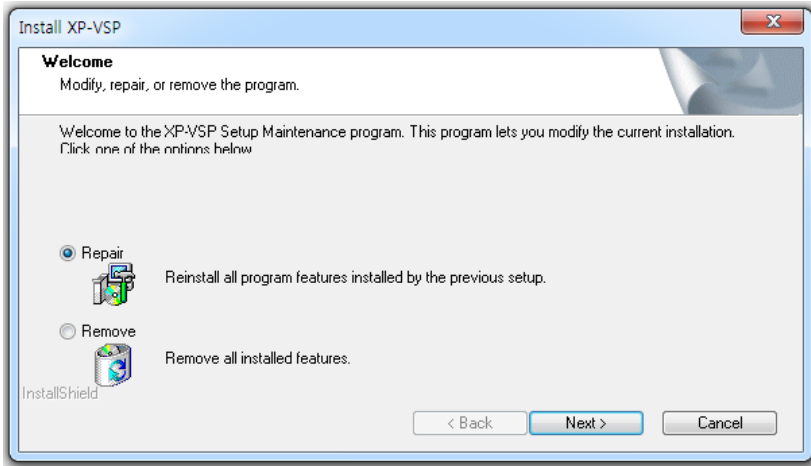

- 3 Follow the instructions in the installation wizard to complete the installation.

4.3 Interfaces and Features

This section describes the XP-VSP interface.

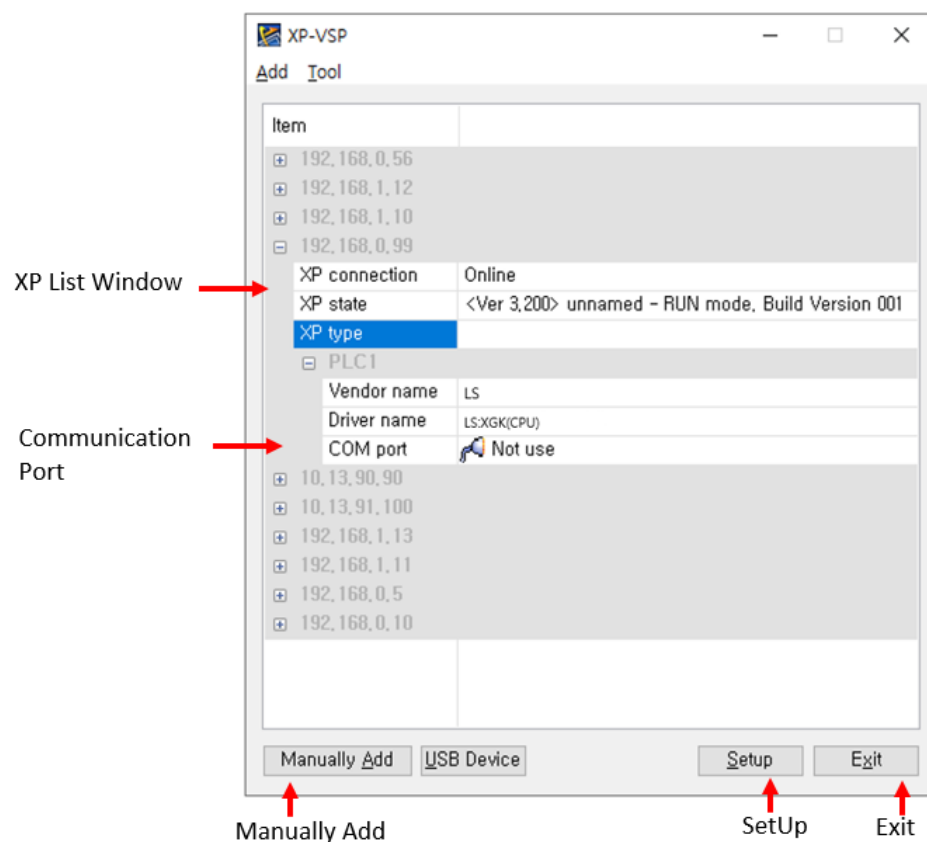

Interface	Description
XP List Window	Shows the online status or the previously registered XP information. <ul style="list-style-type: none"> • XP Connection Status: Online/Offline • XP Status: Shows the current mode or version of XP. • XP Type: Shows the type of XP. • PLC1-PLC4: Specifies the PLC driver that is built in XP. • Manufacturer: Shows the manufacturer of the PLC driver. • Driver: Shows the PLC driver.
Communication Port	For the PLC drivers that do not support XP-VSP, 'XP-VSP not supported' is displayed. If the PLC driver supports XP-VSP, the port number is displayed. You can change the port number.
Manually Add	Set the virtual com of XP that is not online.
Setup	Set the options for XP-VSP.
Exit	End XP-VSP.

4.4 Using XP-VSP

This section describes how to use the XP-VSP software.

4.4.1 Registering Virtual Com Port

To register a virtual com port:

- 1 Download "LS: XGK(CPU)" project using XP-Builder.
- 2 Change the Communication Port from **Do not use** to a random port.

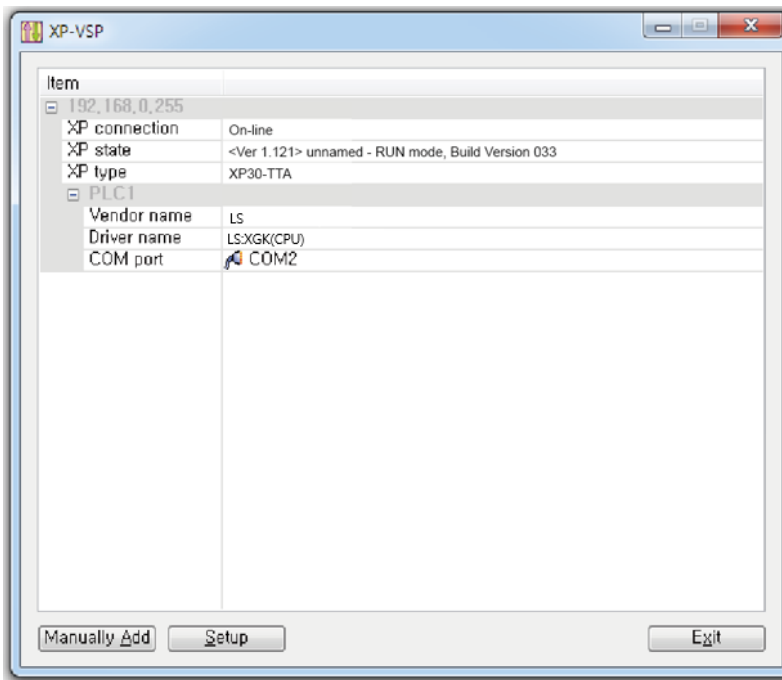

- If the project does not support XP-VSP, you cannot select a virtual com port as shown below.

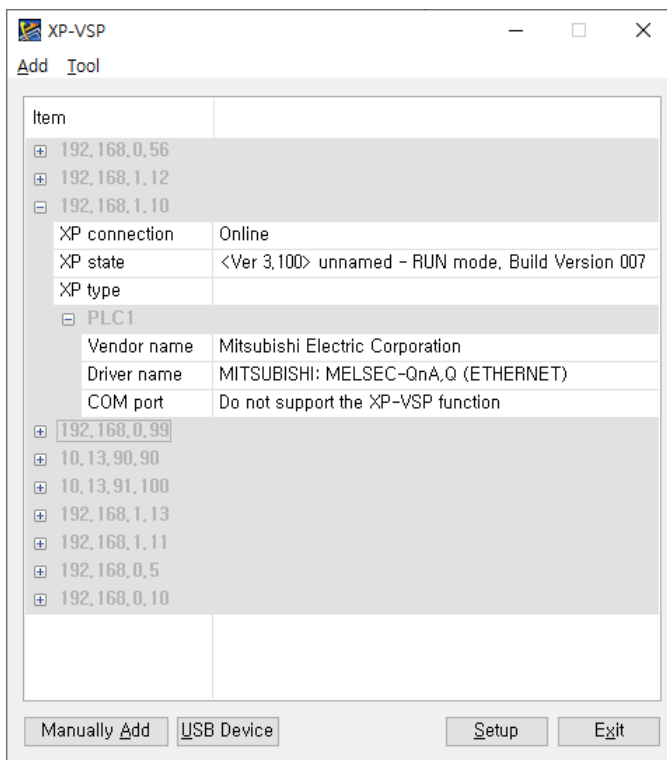

To register a virtual com port directly:

- 1 Click [Manually Add].

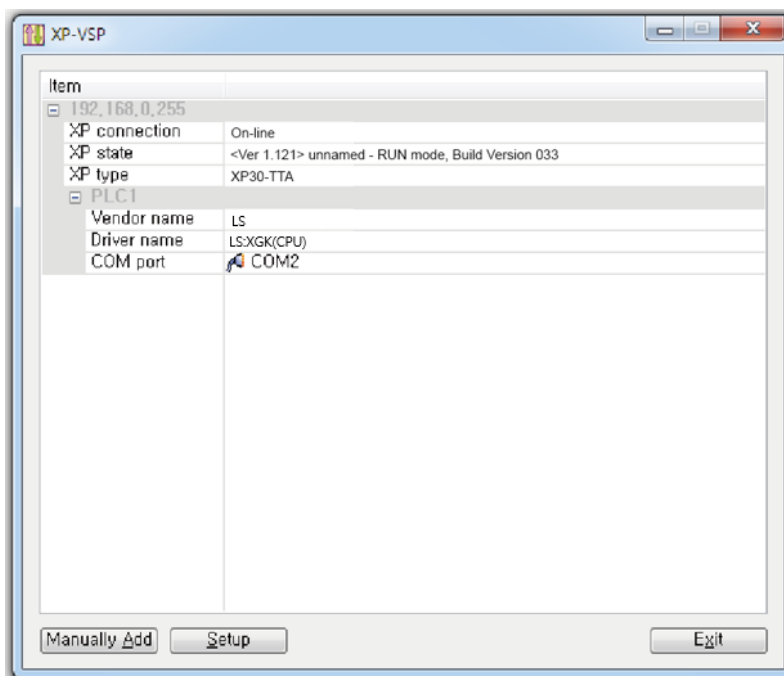

- 2 Enter the following information and click [OK].

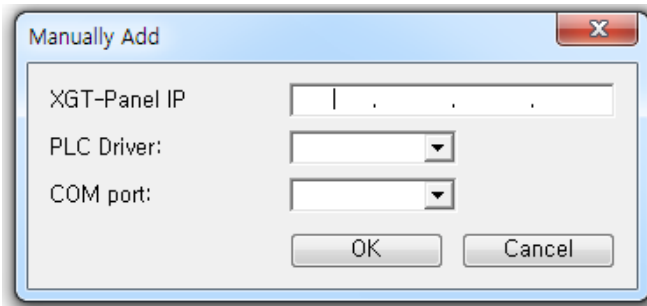

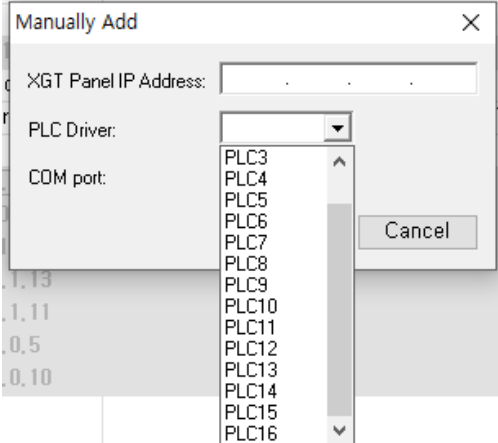
Item	Description
XGT-Panel IP Address	Enter the IP address the virtual com port is registered.
PLC Driver	<p>XGT panel supports 16 PLC drivers at the same time. Select one of the 16 drivers.</p> 
Communication Port	Select the number of the virtual com port to register.

Note

- Once a virtual com port is registered, you can use the port afterward. You do not have to register it each time.
- XP-VSP is supported from XGT-Panel V1.11

4.4.2 Connecting PLC and Ladder Program via Virtual Com Port

You can connect the PLC and the ladder program using the virtual com port that is previously registered. Before connecting, the XGT panel and the PLC must be connected via RS232C.

To connect the PLC and the ladder program via virtual com port:

- 1 Tap [Start] rom the XGT panel's menu to start monitoring.
- 2 Start XG5000.
- 3 Access the menu of XG5000 and select [Online] ► [Connection Settings].
- 4 Set the Method to **RS-232C** and click [Settings].

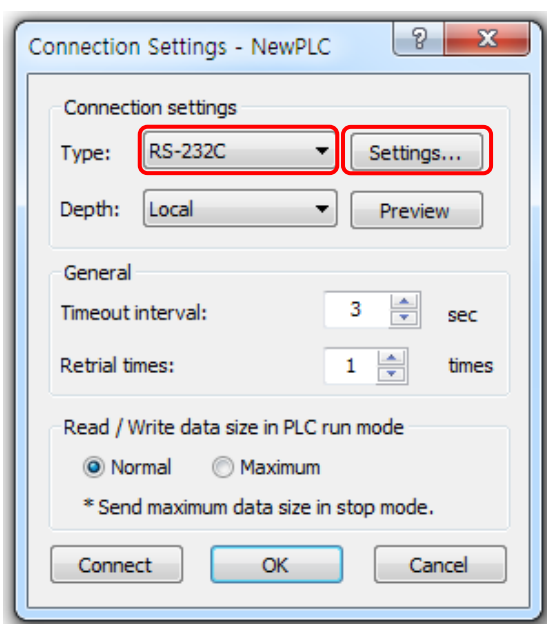

- 5 Set the Connection Port to the virtual com port.

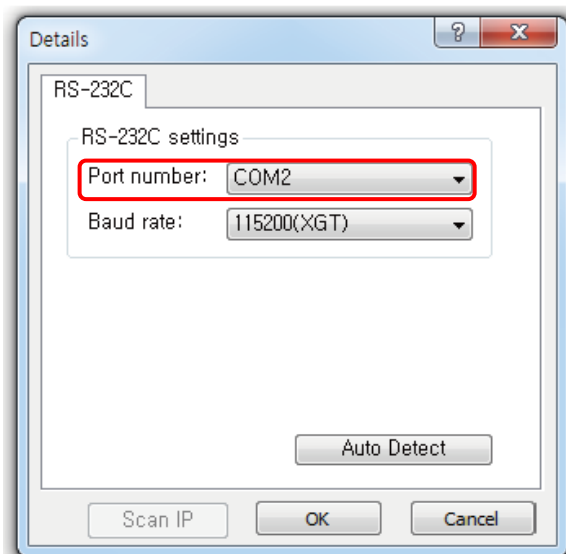

6 Click [Connect] to connect to the PLC.

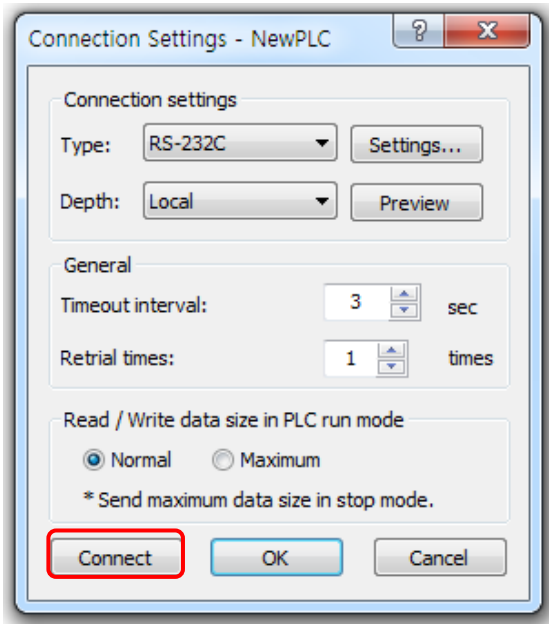

4.4.3 Unregistering Virtual Com Port

To unregister a virtual com port:

1 Change the Communication Port to **Do not use**.

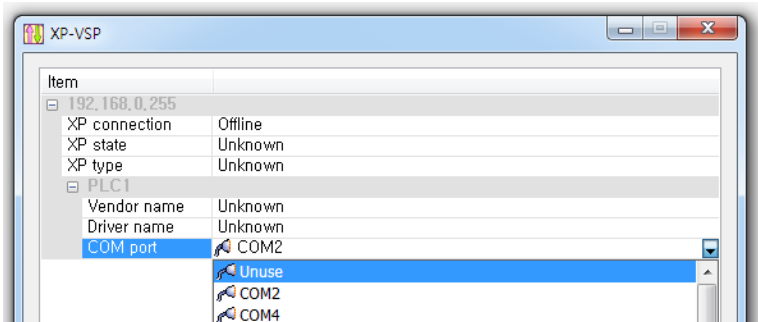

2 Click [Yes] on the pop-up.

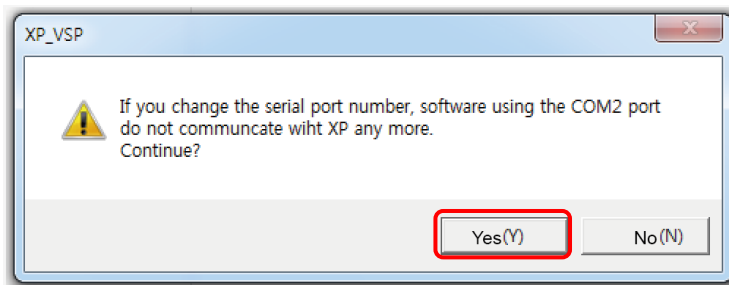

4.5 Editing Default Settings

You can edit default settings in XP-VSP.

To open the settings windows:

1 Click [Setup].

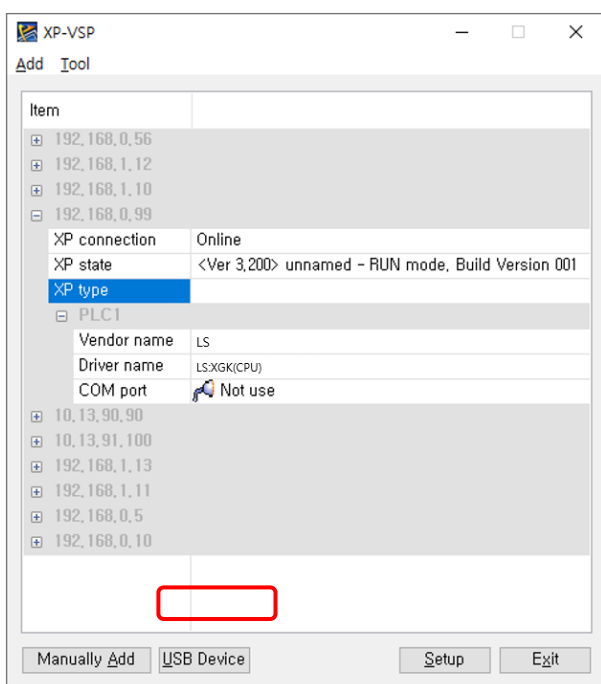

2 Change the following information.

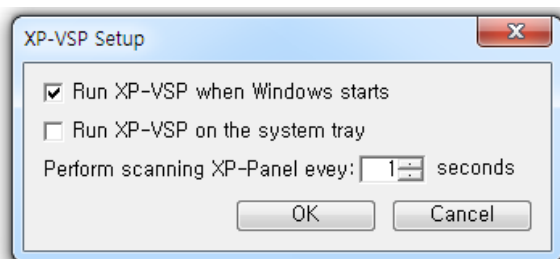

Item	Description
Auto Start XP-VSP on Start	Set to start XP-VSP automatically when the Windows starts.
Start on System Tray	Set to start XP-VSP on the system tray. 
XGT-Panel Search Interval	Set the interval to search for XGT-panel on the network.

5 wXP

5.1 About wXP

wXP is an application designed for LS ELECTRIC's PC-based devices and is used to run the projects designed in XP-Builder.

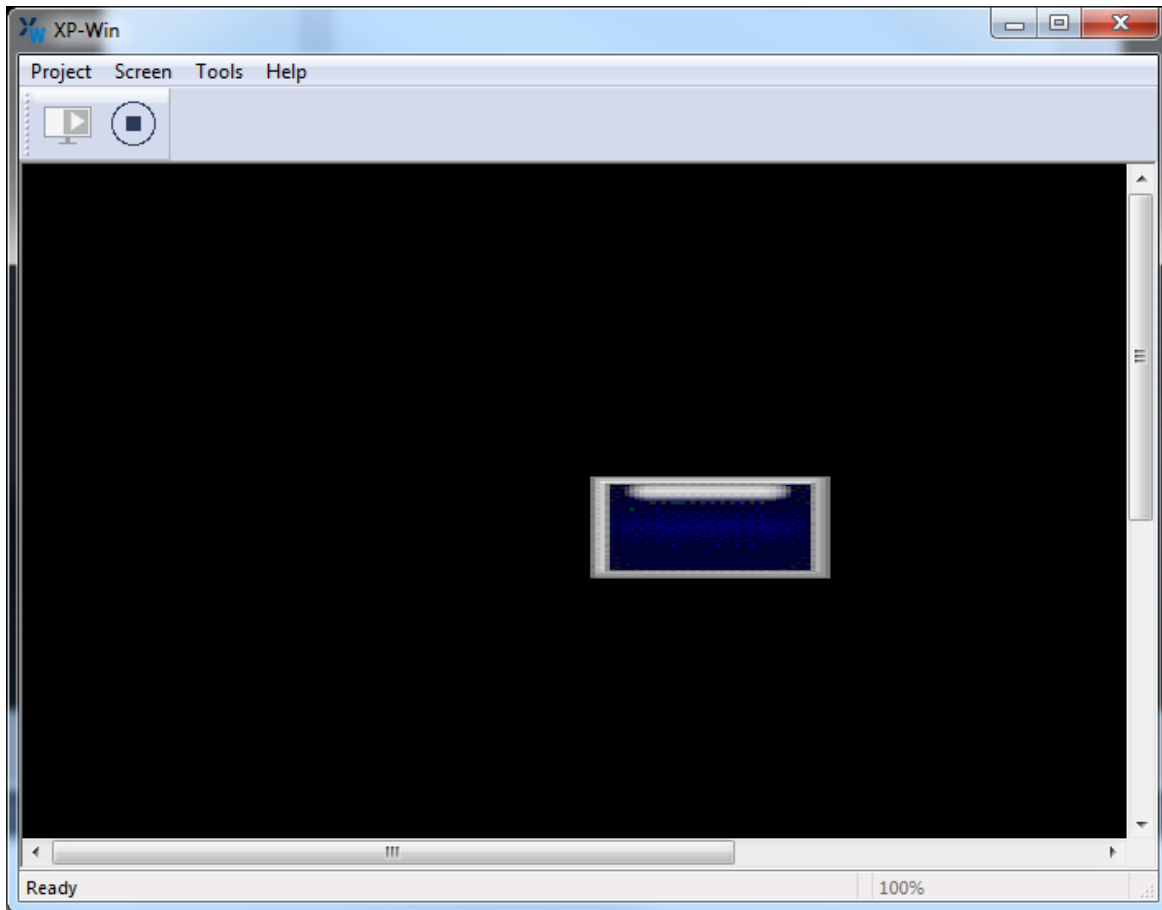

5.1.1 Requirements

The minimum hardware requirements for a PC to run wXP are listed below.

Hardware	Requirements	Remarks
Processor	Pentium4 or above	
RAM	512MB or above	
HDD	1GB or above	
OS	Windows7 or above	

5.2 wXP Interface

The screen configuration of wXP is as shown below. The meaning of each function is as shown below. (Inserted number for each item.)

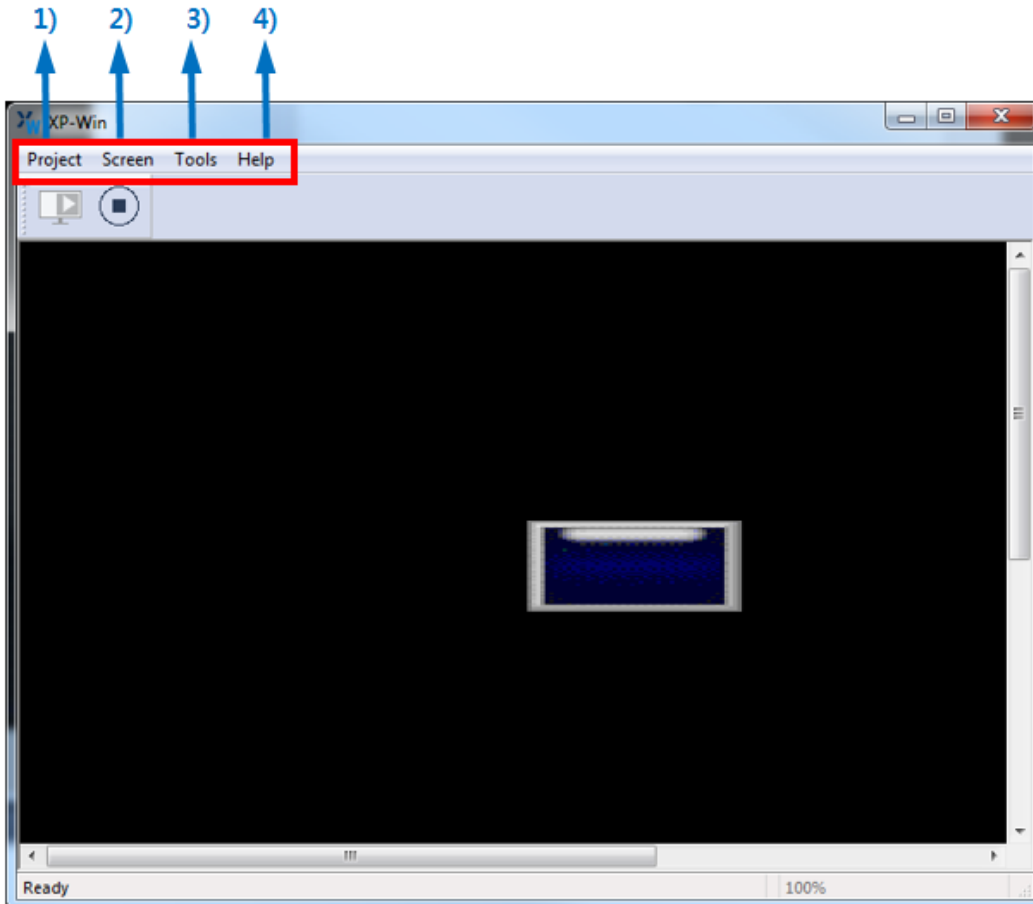

5.2.1 Project

Item	Description
Start monitoring	Start monitoring using the currently downloaded project.
Stop	Stop monitoring.

5.2.2 Screen

Item	Description
Adjust Screen Size to Fixed Size	Set all frames and screens to the sizes specified in XP-Builder (e.g., if the project was designed in 1024 x 768, the project opens in the actual size).
Adjust Screen Size to Frame Size	Resize the screen size to fit the current frame.

5.2.3 Offline Setting

Item	Description
Offline Setting	This is the item which user sets environment of wXP. The setting items are applied when setting in offline. If you change settings in online, you must restart wXP to apply the settings you set.

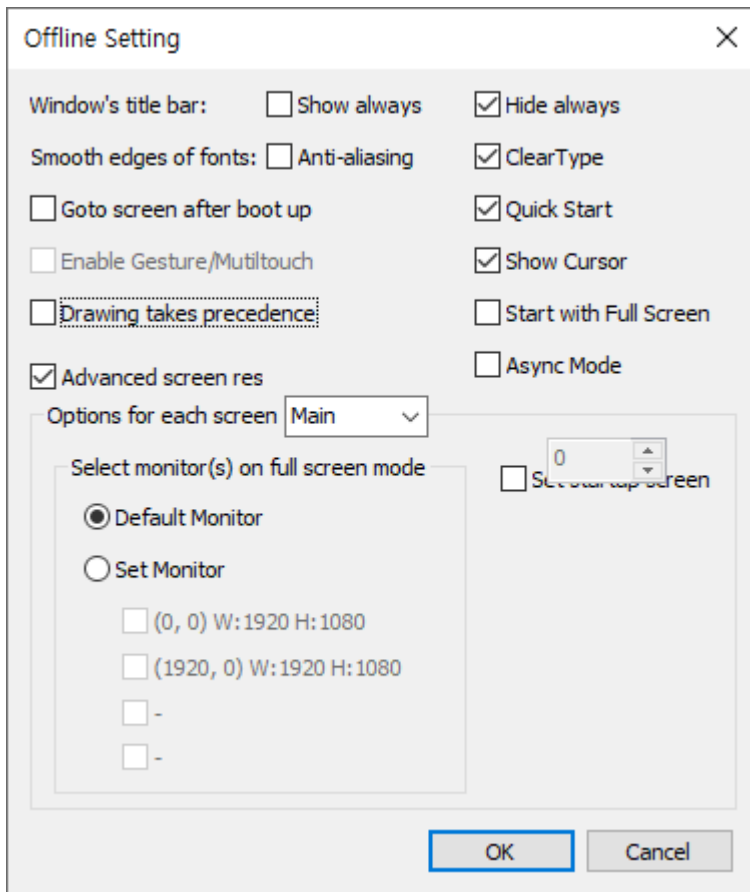

Item	Description
Goto screen after boot up	Start monitoring using the currently downloaded project as soon as wXP is launched.
Quick Start	Set to display the monitoring screen without showing the progress bar for image loading. Since images are loaded when necessary while switching between screens, screen switching may become slightly slower.
Show always title bar of popup window	Set to allow all pop-up windows to be displayed with title bars while monitoring (pop-up window objects, global windows, pop-up numeric keypad windows). When this feature is disabled, the title bar is displayed only when you touch an empty area on the screen.
Smoot edge of fonts	Sets how to soften the outline of each character when the character string entered by the user is displayed on the screen. You can select either the Anti-aliasing method or the ClearType method provided by the Windows operating system. Depending on the font specified by the user or the subjective judgment of the user, the way it is expressed better may be different. When both are unchecked, no smoothing is done, but the screen processing speed is faster than when checked because no additional graphic processing is done.
Start with Full Screen	Set to start wXP in full screen mode. The top menu and frame are hidden from the screen. You can enable this feature when monitoring is stopped to resume monitoring in full screen mode.
Set startup screen	If start screen numbers are assigned, monitoring begins in the order specified by the start screen numbers. Use this option to set your own screen numbers. The original screen numbers will be used if you specify a screen number that does not exist.
Show Cursor	Set to hide the mouse cursor during monitoring.
Gesture / Multi Touch	<ul style="list-style-type: none"> • Set the gesture / multi-touch function. • The default gesture / multi-touch operation (maximum touch point, etc.) is the same as iXP2 (except Handy model). • If the multi-touch / gesture function is disabled on the hardware running wXP, the “Gesture / Multi-touch function” check box is disabled. • Gesture / multi-touch support can be checked in “Pen and Touch” item in “System” information on Windows below. <div style="text-align: center;"> <p>Windows edition</p> <p>Windows 7 Enterprise Copyright © 2009 Microsoft Corporation. All rights reserved. Service Pack 1</p>  <p>System</p> <p>Rating: 7.8 Windows Experience Index</p> <p>Processor: Intel(R) Core(TM) i7-7700 CPU @ 3.60GHz 3.60 GHz</p> <p>Installed memory (RAM): 16.0 GB (15.9 GB usable)</p> <p>System type: 64-bit Operating System</p> <p>Pen and Touch: No Pen or Touch Input is available for this Display</p> </div> <p><When multi-touch / gesture function is supported></p>

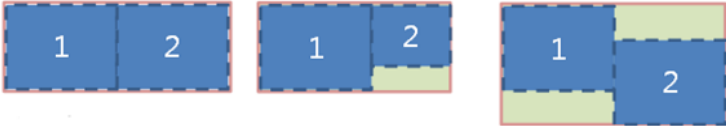
Item	Description
Full Screen Option: Default Monitor	When multiple monitors are in use, set to enter full screen mode on the monitor where the majority of the original screen is displayed.
Drawing takes precedence	If you select [Drawing takes precedence], if the screen has already been entered when changing the screen, the image/value will be displayed first based on the last data displayed at that time. After that, the actual device value is read and the image/value is displayed again. If it is the first screen you enter, it works the same as when [Drawing takes precedence] is deselected.
Async Mode	<p>When deselecting asynchronous operation, the operation sequence is guaranteed when inputting values by bit switches, word switches, and multiple switches. That is, when actions 1, 2, and 3 are performed by multiple switches or overlapping switches, action 2 is performed only when action 1 is completed, and action 3 is performed when action 2 is completed. Therefore, if there is no response from the target controller of motion 1, motions 2 and 3 may also be delayed even if the controllers are different.</p> <p>When selecting asynchronous operation, the operation sequence is not guaranteed when inputting values by bit switches, word switches, or multiple switches. In other words, when operations 1, 2, and 3 are performed by multiple switches or switches arranged overlapping, if each operation is an operation to write a value to a different controller, the It can also operate in sequence. Although the order of operation is not observed, even if some of the controllers do not respond, it can operate quickly for the remaining controllers.</p>
Advanced screen resolution	If you use the [Adjust screen size to frame size] option in the [Screen] menu, the drawing screen will be resized to fit the frame size. At this time, if the size is reduced, the original pixels will disappear, and if the size is increased, pixels that did not exist will be created, which may result in an unsightly shape. If you use the [Advanced screen resolution] option at this time, it will look much better. However, as CPU operation increases, overall performance is affected. We recommend that you do not use the advanced screen resolution option, especially if you are using flow alarms.
Full Screen Option: Set Monitor	<p>When multiple monitors are in use, set to specify full screen mode display options. The following are principles used for the display options.</p> <ul style="list-style-type: none"> • The top-left corner of the 1st monitor becomes the top-left corner of the monitoring screen. • The monitoring screen size is adjusted to include all the monitor screens. • You cannot view the areas of the monitoring screen beyond the areas covered by the monitor screens. <p>Refer to the following figure for actual application. The orange outline specifies the entire monitoring screen, while the green blocks are the unseen areas.</p> <p>When 2 monitors are used:</p> 

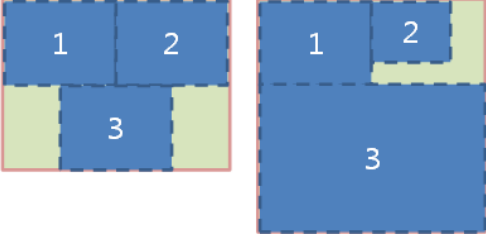
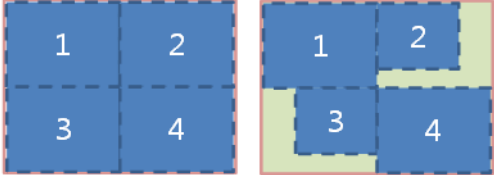
Item	Description
	<p>When 3 monitors are used:</p>  <p>When 4 monitors are used:</p> 

5.2.4 Help

Item	Description
Help	Displays the version information of wXP

5.3 wXP Restrictions

You may experience the following restrictions when working with wXP.

Item	Description
Unsupported service	wXP does not support printing, XP-Remote, Web server, VNC server, or PLC program monitoring services.
Special switch	wXP does not support safety interlock switch, program monitor switch, or other special switches related to XP_Remote.
Script function	wXP does not support backlight settings, USB power reset, buzzer, buzzer activation, alarm, or screen print script functions.
License Key	The license key provided at the time of purchase of wXP must be connected to the device to use software normally.

6 Object Display Rule before Communication Connection

Object	Before 1 scan completed	Time Out
Lamp Object	Not Displayed	Display Default Image
Message Object	Display Image	Display Image
Numeric/Text Object	Display Image	Display Image
Graph Object	Display Graph	Display Graph
Animation Object	Display Image	Display Image
Window Object	Not Displayed	Not Displayed
Part Object	Not Displayed	Not Displayed

7 Glossary

Term	Description
1: 1	“one to one” communication; a communication mode; in 1: 1 communication, one panel is used to send commands to one controller
1: N	“one to many” communication; a communication mode; in 1: N communication, one panel is used to send commands to multiple controllers
baud	baud and bits per second are not necessarily the same, so do not use "bits per second" or "bps" as a synonym for baud; modems are conventionally designated by bits per second or kilobits per second; a 28.8 kbps modem runs at a different baud, depending on how events are coded for transmission
bit object	an object in an XP-builder project that is controlled by a bit device
bitmap	refers to a specific file format for online art
case	a selection control mechanism that exists in most imperative programming languages, such as Pascal, C/C++, C# and Java; it allows the value of a variable or expression to control the flow of program execution via a multi-way branch (or “go to,” one of several labels); in XP-Builder, cases are used to control the operations assigned for individual objects, by providing multiple conditional expressions where the object’s device value is one of the operands.
condition	a Boolean expression used to control conditionals and loops; it affects the programming or operating of control statements, such as WHILE, FOR, and IF; in XP-Builder, conditions are used to control the operations assigned for individual objects, by providing a condition or conditional expression where the object’s device value is one of the operands.
controller	the physical unit that delivers instructions to machinery; XP-Builder supports numerous types of controllers; see also <i>programmable logic controller</i>
DEC keypad	a Window screen for user input of decimal characters
editing area	the main part of the XP-Builder interface, where objects can be placed to create a project
Ethernet	a connection method; the maximum throughput for an Ethernet connection is 100mbps
falling edge	the bit at which the device turns off is the falling edge
FLOAT keypad	a Window screen for user input of float characters
HEX keypad	a Window screen for user input of hexadecimal characters

Term	Description
IL language	intermediate language; the language of an abstract machine designed to aid in the analysis of computer programs
inverter	an electrical power converter that changes direct current (DC) to alternating current (AC); the converted AC can be delivered at any required voltage and frequency with the use of appropriate transformers, switching, and control circuits
log	Automatically produced and time-stamped documentation of events relevant to a particular system. In XP-Builder, you can enable logging option in a particular object's property setting window to track and record the operation
N: 1	"Many to one" communication; a communication mode; in N: 1 communication, multiple panels are used to send commands to the same controller; this is an atypical configuration.
offset function	a function to specify a device address by referencing an "offset" from the starting address
operator	a symbol used to connect expressions; <i>logical operators</i> are used to create a test expression that controls <i>program</i> flow; relational operators test or define some kind of relation between two entities
range	the set of values to be included in a function
raster image	a bitmap image with a dot matrix data structure representing a generally-rectangular grid of pixels or points of color; a raster image can be in varying formats, such as GIF, JPG, and BMP
rising edge	the bit at which the device turns on is the rising edge
RS232	A series of standards for serial binary single-ended data and control signals connecting between data terminal equipment (DTE) and data circuit-terminating equipment (DCE). The maximum throughput for an RS232 connection is 115Kbps.
RS485	A standard for defining the electrical characteristics of drivers and receivers for use in balanced digital multipoint systems. RS485 offers data transmission speeds of 35 Mbit/s up to 10 m and 100 Kbit/s at 1200 m.
screen	the basic component of an XP-Builder project, where user interfaces (objects) are placed
script	a small program written for a command interpreter or another scripting language
servo	Servomechanism; a device used for control of a desired operation through the use of feedback; the term correctly applies only to systems where the feedback or error-correction signals help control mechanical position, speed, or other parameters.
token	a credential used to control usage rights; the node that holds the token has the current usage rights

Term	Description
toolbar	part of the XP-Builder interface where menu shortcuts are designated by icons and buttons
unsigned decimal	a system for expressing negative numbers
vector image	an image based on paths or strokes, for the representation of geometrical primitives, such as points, lines, curves, and shapes or polygons; because vector-based images are not made up of a specific number of dots, they can be scaled to a larger size without losing image quality
window	either the windows of the operating system (MS Windows) or partial screens that are created and used in XP-builder
word object	an object in an XP-builder project that is controlled by a word device
XG5000 Simulator	A simulator for testing PLC logic programs. It can be run with XP-Simulator to test operation of an XP-builder projects

8 List of Acronyms

Acronym	Definition
A/V	audio/video
ASCII	American standard code for information interchange
BCD	binary code decimal
CF	compact flash
CMY	cyan-magenta-yellow
CMYK	cyan-magenta-yellow-black
COM	communications
CPU	central processing unit
DEC	decimal
GIF	graphic interchange format
GUI	graphical user interface
H/W	hardware
HEX	hexadecimal
I	used in device expressions to represent input
IB	used in device expressions to represent byte input
IEC	International Electrotechnical Commission
IL	intermediate language
IP	internet protocol
IP	ingress protection
IW	used in device expressions to represent word input
JPEG	joint photographic experts group
LAN	local area network
LC	liquid crystal display
LD	ladder diagram
LED	light emitting diode
M	metadata
MPEG	moving picture experts group
PC	personal computer
PDF	portable document format
PIN	personal identification number

Acronym	Definition
PIR	passive infrared
PLC	programmable logic controller
Q	output
QB	bit output
QCIF	quarter common intermediate format
QVGA	quarter video graphics
QW	word output
RAM	random access memory
RGB	red-green-blue
ROM	read-only memory
S/W	software
SD	secure digital
SDK	software development kit
SMTP	simple mail transfer protocol
SRAM	static random access memory
TCP	transmission control protocol
TIFF	tagged image file format
UDP	user datagram protocol
UI	user interface
URL	uniform resource locator
USB	universal serial bus
VGA	video graphics array
VM	virtual memory
VSP	virtual serial port
WAN	wide area network

9 Caution

LS ELECTRIC's HMI device must only use the font included with Microsoft's WinCE license (link below), the user is responsible if any other font is used.

XP Series: [https://docs.microsoft.com/en-us/previous-versions/windows/embedded/ms901084\(v%3dmsdn.10\)](https://docs.microsoft.com/en-us/previous-versions/windows/embedded/ms901084(v%3dmsdn.10))

iXP/eXP Series : [https://docs.microsoft.com/en-us/previous-versions/windows/embedded/ee489823\(v%3dwinembedded.60\)](https://docs.microsoft.com/en-us/previous-versions/windows/embedded/ee489823(v%3dwinembedded.60))

iXP2 Series/eXP2 Series : [https://docs.microsoft.com/en-us/previous-versions/windows/embedded/ee489874\(v%3dwinembedded.70\)](https://docs.microsoft.com/en-us/previous-versions/windows/embedded/ee489874(v%3dwinembedded.70)).

